

TERRY PRATCHETT

ALAN BATLEY & BERNARD PEARSON

THE UNSEEN UNIVERSITY CUT-OUT BOOK



Build your very own **Unseen University**

The Unseen University sits in the centre of Discworld's greatest city, Ankh-Morpork. Some would say it is the very heart of the city. Ancient and magical, it is home to the greatest library in the multiverse and the oldest building on the Discworld, the soaring Tower of Art.

Enjoy the challenge of making all seven buildings and seeing the complete Unseen University literally unfold before your eyes. Created in perfect detail by renowned illustrator and model maker, Alan Batley, from the original sculpture of the University by Discworld artist Bernard Pearson.

- WITH A FOREWORD BY TERRY PRATCHETT
- SIMPLE TOOLS, PATIENCE, AND A GOOD POT OF GLUE ARE ALL THAT IS REQUIRED TO CREATE THIS MASTERPIECE
- COMPREHENSIVE AND EASY-TO-FOLLOW INSTRUCTIONS THROUGHOUT

NOT SUITABLE FOR CHILDREN

Cover photography: Johnny Ring
Cover and text design: xht design

ISBN 0-385-60944-2
ISBN 978-0-385-60944-9

UK £14.99
Can \$37.95



9 780385 609449

www.booksatransworld.co.uk/terrypratchett



The Library

The Boat House



Modo's Garden Shed



The Wall of Names



The River Wall



The High Energy Magic Building



The Great Hall Part I



The Observatory



The Tower of Art



The Great Hall Part II



The Clocktower

TERRY PRATCHETT
ALAN BATLEY & BERNARD PEARSON
THE UNSEEN UNIVERSITY
CUT-OUT BOOK

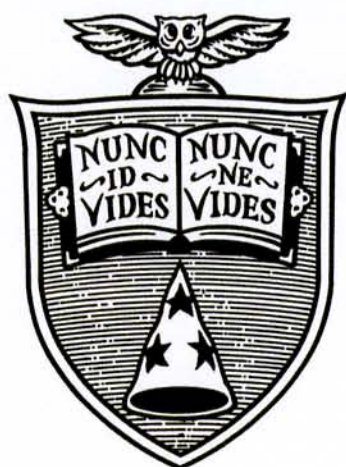

Doubleday

LONDON • TORONTO • SYDNEY • AUCKLAND • JOHANNESBURG

EVERYTHING UNDER ONE ROOF

It's just possible, statistically, that you don't know what Unseen University actually is, and bought this book because it had a rather fetching cover. Well done!

It is the Discworld's* greatest university of magic. Don't let the venerable, ivy-clad outside fool you; the space inside might technically be larger than the universe, according to the brash young wizards who work in the High Energy Magic Building. Certainly there is at least one corridor that has been found to be more than a thousand miles long, and the Library is so extensive that whole species have evolved to live in it. The room created to examine the contents of the Cabinet of Curiosity is half a mile high, a feat achieved by the realization that you can stretch space if you shorten time, so a day's research in there can easily be done in a second, which is a clear boon to students.

It is a storehouse of knowledge, on the premise that it's a good idea to keep knowledge carefully locked up somewhere so that idiots don't run around trying to make weapons of it. More accurately it closely resembles an attic of knowledge. Everything is in there somewhere, but probably stuck behind a two thousand year accumulation of old carpets, collapsed suitcases and diresome rusted tin boxes with the key missing.†

Wizards also seldom throw anything away, and that includes people. Somewhere in those endless acres of masonry and old oak is a wizard who is an expert on *anything*. Admittedly, he may not still be alive, but that is no barrier to a continuing successful career at UU, where tenure really *means* something...

And so on. Unseen University was invented back in the early Eighties as, well, a university for wizards, where they study and in theory teach magic, although they mostly teach people who already know how to use it how not to use magic, which is a lot harder than all the glingle-glinge business with the wands. It seemed right that the location of such a place should have absorbed so much of the ambient magic that it had become magical in its own right and, to some extent, alive. And living things change. Extra bits evolved, most importantly the High Energy Magic Building, where sufficiently advanced magic is indistinguishable from quantum physics, except that quantum physics is short on dribbly candles and doesn't have such pretty twinkly lights, unless by chance the particle accelerator blows up. In the HEM higher and higher boundaries are pushed back further and further every day because They Are There, although of course the intention is that tomorrow they won't be.

What a shame we couldn't print this book in eleven dimensions.

Why does it exist at all? Well the similar-sized, painted, limited resin and plaster edition of UU is not only a collectors' item but weighs as much as half a bag of bricks. It was and still is a wonderful

* I'm not explaining this bit. You already know, don't you?

† Don't bother to look for it. Wizards tend to keep the keys to locked boxes inside them, for safety.

thing, but it has caused tables to creak across the country. We thought it might be time for something a little lighter and far less limited.

Besides, I used to love cut-out books. When I was about nine, model railways taught my generation never to believe the picture on the box. Picture on the box: Clapham Junction at rush hour. Inside the box: four straights, eight curves. A lesson about life, that. Some golden opportunity appears to beckon, some glittering prize dangles before you – and on closer inspection you realize it doesn't even include a signal box.

But from somewhere I acquired a big, thick book containing a *cut-out* railway. It had everything, including a passable attempt at Waterloo Station and three different sorts of signal box. All you needed was a sharp knife, a tube of glue and about 150 hours, which in that pre-TV age were in ample supply. It was also a great saving in electricity which, too, which was good because we didn't have any. I built the whole damn thing, and it looked great. Then it whirled away on the winds of time, as things do. I can still smell the ink, and see the pages crammed with possibilities. I ought to have bought another copy, and saved it for now, when I'm allowed sharper knives and probably wouldn't get glue all over the Royal Scot.

Sigh...

Hey, that's an idea. Why not buy two copies?

Terry Pratchett

June 2006

IT'S ALL IN THE MIND

Now I must confess I am no stranger to imaginary landscapes. Over the years I have made a sort of living in translating the written word into bits of sculpture. I have created lots and lots of things that need dusting, bijou sculpture for the domestic environment, not your big gallery fine art stuff. Mine was the sort of whimsical bit that lurks on a bookcase, the odd mantelshelf, and latterly on e-Bay.

I have made all sorts of things inspired by the writings of clever authors: Bag End, Rivendell, Minas Tirith, a Grail Castle or two, Ruatha Hold, and numerous folksy buildings for a variety of companies that enjoyed a brief boom time in the 1980s.

I had even rendered a couple of Discworld images, but small beer compared with the task I was to undertake in the spring of 1997.

I really love sculpting buildings. There is something rather magical when, if you get it really 'right', a building comes alive in a way that a figurative sculpture never really can. I suppose it's because we never expect to see a building move, whereas when you paint or sculpt the human form you nail down the movement, render a living thing into a monument. But you mustn't include figures in your building. Figures make it static. Do it right, though, and it should look as if figures might turn up at any minute.

One day I gave Terry a Grail Castle, one of my best pieces if I say so myself. He liked it, and it led on to a detailed discussion of the possibilities of creating Unseen University. The more we talked the more I could see a little door opening up into a landscape I had never really explored as a craftsman.

The Unseen University is remarkably well described within the canon of Discworld literature. Both the inner and outer are visited in a number of books, and one gets a real feel for the place. Never having been to a university I had all the preconceptions imbibed from film, television, and books. This was both a help and a hindrance. A help in that the 'Dreaming Spires' and such like of Oxbridge are visually well represented in books, and not too far from where we were living to visit. A hindrance in that my only 'feel' for the place was through other people's images. Terry builds pictures in people's minds, but the foundations are solid and as with almost all of Terry's writing, the bedrock is real life. I needed to get inside an old university so that I could sculpt the outside of an imaginary one.

Families can be a wonderful seam to mine. A dear sweet niece showed me around her rooms and the environs of her ancient college, and a wayward son took me drinking in the seamy bars of Cambridge with his dissolute chums, an education in itself.

Then back to the studio, where over a period of eighteen months I turned various large pieces of sculptors' wax into bits of building. I used all the techniques that I had learned over the previous twenty years and explored almost every architectural style from the Saxon to the red-brick Sixties. At every stage, when a building was finished I drove to Terry's where it was looked at and judged. Sometimes there were just a few minor changes that had been brought about by plot and circumstance. I was asked for small

additions in places that really made no sense until I read about them in books written long after the particular building was finished, one important growth of ivy on the Library roof being a case in point. God knows how Terry knew it would be needed ten books later.

We produced and sold an edition of just 250. Each one was made by the hand of Vincent Cowdrey who has been working with Isobel and me for years. Alan Batley has done a tremendous job in bringing the Unseen University to the most difficult medium of paper.

We've left the easy bit to you...

Bernard Pearson

The Cunning Artificer. Somerset, June 2006

GETTING STARTED

EQUIPMENT NEEDED

1. A good quality **craft knife**. We recommend a Swann-Morton surgical knife with 10A blades; you can buy these from most good art and craft shops. The blades are available in packs of 5 or boxes of 100. Be careful when using this type of knife, particularly when changing blades. Use one of the purpose-designed tools to do this and make sure that you dispose of the old blade safely, wrapping it well.

2. To get the best results you will need a **glue** which sets reasonably quickly, but not instantly. We recommend you use a spirit-based glue like Bostik All Purpose. A PVA glue that can be applied by brush may also give good results.

3. You will also need a **cutting mat** or board, a **pencil or pen** (we recommend a pencil with a fairly soft lead: HB or B), a **steel ruler** to use as a cutting guide, some **tweezers**, **A4 envelopes** in which to keep the pieces in between cutting out and assembly, the **inner card tube** of a kitchen roll (we'll explain later), **kitchen roll** for wiping off excess glue, and a **flat surface** on which to assemble the buildings. This last is important and will help make the buildings 'sit flat' in the finished construction.

A KEY TO THE ARTWORK

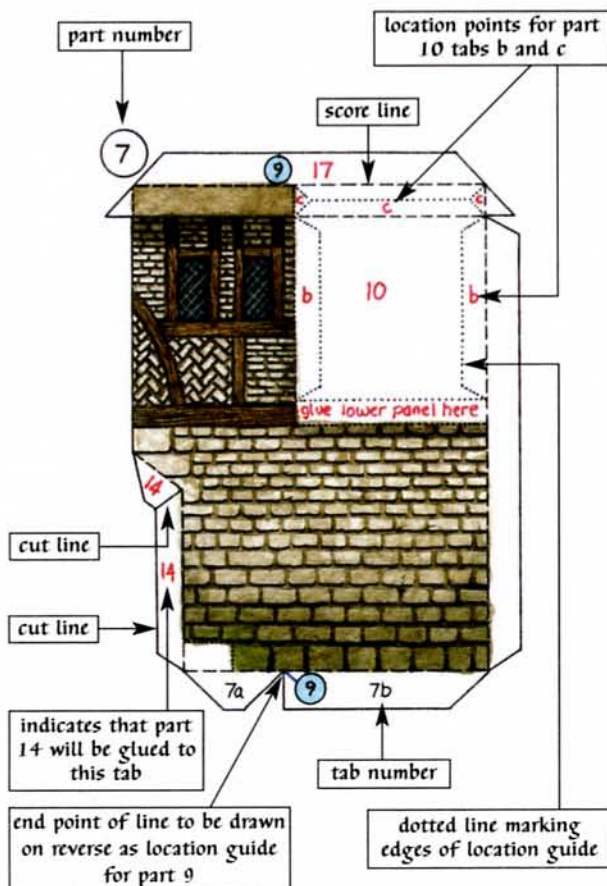

Within each building every component part is numbered in sequence from 1. (Unfortunately space doesn't allow us to present the parts in strict numerical order on the page.) In most cases the glue tabs are each identified by letter (*a, b, c*) or part number and letter (*7a, 7b*), printed in black. Wherever possible, the location to which the tab should be glued, on the floor plan or another component, is indicated with a dotted line and the tab name in red. For parts that are to be glued on direct rather than with tabs (e.g. roofs and buttresses), there are similar location areas, marked in red with the relevant part number. In a few cases you will need to draw in your own location guide-line on the reverse (unprinted side) of the paper. Numerals in blue circles give the number of the part that will be glued to your line and arrow the end-points of the line you must draw.

Lines to be cut are printed as solid black lines. Lines to be scored for folding are shown as dashed lines. Dotted lines outline location areas (see above).

GENERAL HINTS AND TIPS

1. Cutting

Accuracy in cutting is important, particularly where a coloured area comes up to the cut edge. You will never achieve this with a blunt knife, so change the blade frequently. Use your steel ruler as a straight edge to cut against: anchor the ruler with the fingers of your non-cutting hand, keeping the fingertips well back from the edge, and cut towards you. Always watch what you are doing – any slip in concentration may result in accident or injury. (And when you are not actively using your knife make sure not to leave the blade unguarded.)

2. Scoring

Accurate scoring is just as important as accurate cutting. To score you should use the back (non-cutting edge) of your craft knife blade. You are advised to practise first, to make sure you can avoid cutting right through the paper. Score curved lines and circles slowly, particularly the small circular areas. Don't use sweeping movements. Make sure you have done all the necessary scoring while the paper is still flat: it's almost impossible to add a score to a three-dimensional shape (see tip on pre-folding below).

3. Bending

Some parts will require bending in order to make turrets, domes or curved roofs. It is best to roll the paper beforehand – you'll get a better result when it comes to assembly. Try rolling the paper around a cylindrical object like a pencil; for the bigger pieces like the Tower of Art you'll need something larger, which is where the inner tube of the kitchen roll comes in handy.

4. Gluing

Always use just enough glue to do the job. Too little and the tab won't stick, too much and you'll end up with glue everywhere. Apply glue right to the edge of the tab (or other area to be glued), wipe off excess glue with kitchen roll, wiping your fingers as well, then press the part in place. Except where the instructions specify otherwise, the glue should be applied to the tabs rather than the location areas.

When gluing a tab to the edge of another section of the model, always make sure that the folded edge of the tab is flush with the edge of the section you are gluing it to.



When you glue a tab to a location guideline you have drawn on the reverse side of the paper, the folded edge should always be level with the line (see diagrams).

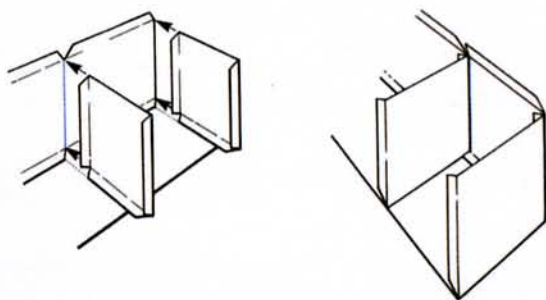

5. Blending in cut edges

To prevent exposed cut edges from showing as white lines, you can rub a soft pencil along the edge before the part is glued in position. It doesn't matter that the colour won't match exactly; the grey will be enough to stop the white edge staring.

PRELIMINARY STAGES

Experienced modellers will already have their own preferred working methods; to others we suggest you proceed as follows:

1. For each building first read through the whole of the instructions and examine the diagrams and artwork. In particular this should help you identify all the lines that require cutting or scoring.
2. Deal with any guidelines that need drawing (indicated by pairs of numbered blue circles): lay your ruler across the two points to be joined; make a short cut at either end, outside the outline of the building part; then turn the paper over and draw in a pencil line to join the two cut-marks. Label the line with the number appearing in the blue circle.
3. Score all the dashed lines on the page.
4. Carefully cut out the pieces. Be alert for cut lines that go inside the outline, e.g. to separate two tabs.
5. As you finish cutting each part, number it on the reverse and put it into an envelope for safekeeping.

How many envelopes you use is up to you (one per building, say, or one for parts 1–10, another for parts 11–20, etc.), as is the number of parts you cut before you start any gluing. If you leave a portion of a page uncut, make sure you keep that safe in an envelope too.

6. Pre-fold each part as you come to use it, before applying any glue, to check that all the necessary lines have been scored.

In the detailed assembly instructions that follow, it is assumed that you have already cut out the floor plan for the building and have done all the scoring, cutting and drawing of guidelines on the required components.

When fitting parts, don't be afraid to make slight adjustments by trimming or rescoring. It is a paper model and consequently it will be hard to achieve perfect accuracy during construction. If you have any bad joints or exposed areas on the model use the spare parts provided on page 165 to cover these areas. Alternatively you can use acrylic paint to disguise the joins, but this is only advisable on small areas otherwise there is a danger that the paper may buckle when it becomes wet.

Be patient. This project is quite demanding and intricate, but we hope you will be pleased with the result.

THE LIBRARY

FIG. 1. Draw a line on the reverse of **part 1** across the gable end, level with the base of the tabs on either side.

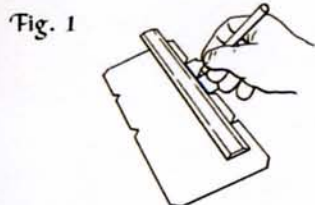

FIG. 2. Glue **part 1** onto the floor plan. Glue tab *1d* to the underside of the adjacent tab to form the ridge support (see FIG. 2A). Glue **part 2**, making sure that tab *2c* fits between the top tabs of **part 1** (see FIG. 2B).

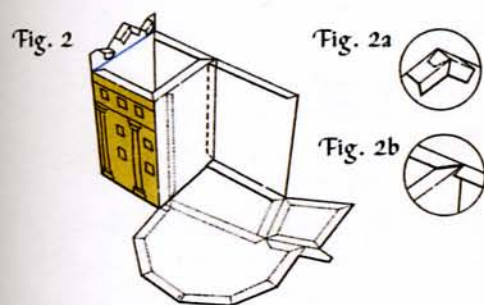
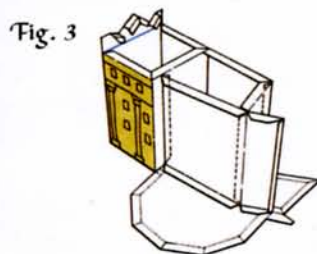

FIG. 3. Glue **parts 3 and 4**, ensuring that **part 3** is fixed to the end of the long wall section of **part 1** and to **part 4** where it folds back slightly.



FIGS 4, 4A. Glue **part 5** into position. It's advisable to do this in stages as illustrated.

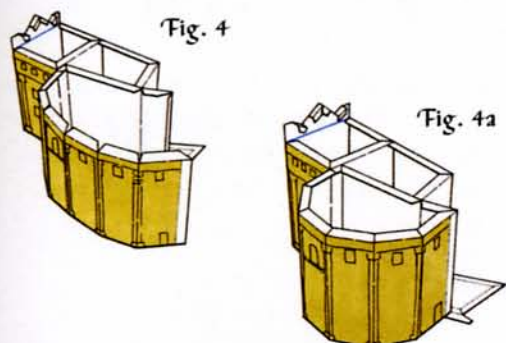
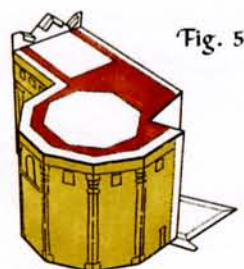

FIG. 5. Glue **part 6** (roof terrace) in place. Start with the folded tab *6a*, ensuring it is level with the line you drew earlier. Take care to align the six sections of wall (**part 5**) when fixing. If there are any small overhangs you can trim carefully afterwards.



Parapets

FIG. 6. On **part 7**, glue tab *a* to the underside of the opposite wall.

FIG. 6A. Glue the long top section to tab *b* and the two sloping sections to the four tabs *c*.

FIG. 6B. Glue both ends to the six tabs *d*.

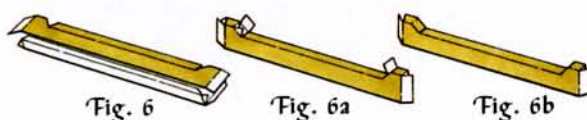

FIG. 7. On **part 8**, glue both ends shut using the three tabs *a*.

FIG. 7A. Glue tabs *b* to the base.

FIG. 7B. Glue top to tabs *c*.



FIG. 8. Glue **part 7** in position, making sure that the square end is fixed to the gable section of **part 1**. Glue on **part 9**, ensuring that the tabs on **part 1** are flush with the top of the gable. Glue **part 8** and then **part 10** in position to complete the gable end.

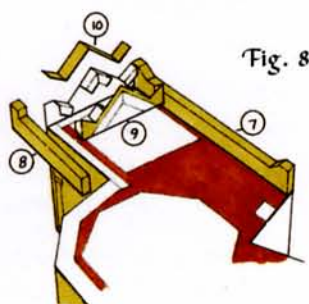

FIG. 9. On **part 11** glue tabs *a-f* to the underside of the corresponding top sections.

FIG. 9A. Fix both ends by gluing and tucking in tabs *g*.

FIG. 9B. Once assembled place **part 11** on a flat surface with the base faces down and gently pull in each end.

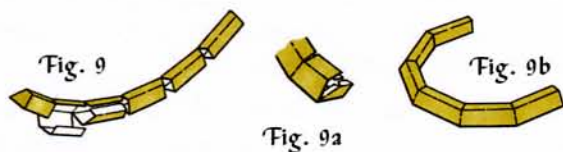

FIG. 10. Assemble the roof section (part 12).

FIG. 11. Glue parts 11 and 12 in position.



Fig. 10

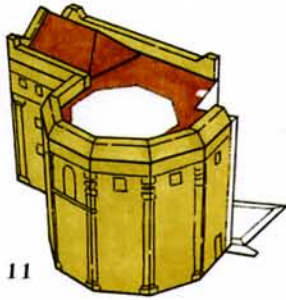

Fig. 11

The dome

FIG. 12. Apply glue to all the tabs *a-g* on part 13. Starting with the tabs closest to the hinge (*a* and *b*), set the tabs in position. Once all the tabs are glued down, place the assembled part on a flat surface and make sure that it is as even as possible before the glue sets (see FIG. 12A).

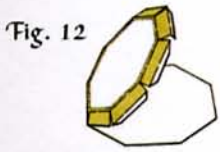

Fig. 12



Fig. 12a

FIG. 13. Assemble part 14 as shown to form an octagon.

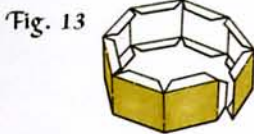

Fig. 13

FIG. 14. Roll each section of part 15 round a pencil or similar cylindrical object to form a natural bend.

FIG. 14A. Glue tab *a1* to the inside of section *a*, making sure the bottom edges are level.

FIG. 14B. Glue section *e* to the segment marked *e* (in red) on the octagonal tab, then glue sections *c* and *g*.

FIG. 14C. Glue the remaining sections to their corresponding segments on the octagonal tab and to the tabs provided on the sections either side.

FIG. 14D. If there are any gaps showing between the panels of the dome once you've assembled it, you can if you wish cover the joins with brass ribs, parts 41-48 (note: the artwork includes two extra parts as spares). Simply score and fold each rib down the centre line, bend it and glue it on so that it covers the joint between two panels.

Now glue the three sections of the dome together and fix to the roof terrace on the main building (see FIG. 22).

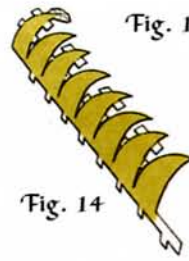

Fig. 14



Fig. 14a



Fig. 14c



Fig. 14b



Fig. 14d

Weather vane

FIG. 15. Assemble part 34 by gluing the end panel to tab *a*. Cut a slot in the centre of part 35, about 3mm long, then assemble by gluing the end panel to tab *a*. Fold and glue part 36 and cut the folded end into a point.

FIG. 15A. Fold and glue part 37 so that it wraps around part 36.

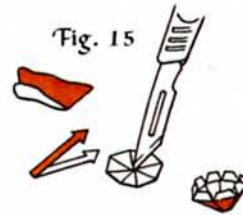

Fig. 15



Fig. 15a

FIG. 16. Push part 36 into the slot in the top of part 35. Apply glue round the slot from the inside to fix the parts together.

FIG. 16A. Assemble the weather vane by gluing tabs *b* on part 34 to the underside of part 35, then glue part 34 to part 33. The weather vane is now ready to glue to the top of the dome, but you may prefer to do this after the rest of the building is complete (see FIG. 22).



Fig. 16



Fig. 16a

Towers

FIG. 17. Assemble part 16 (main tower): glue the sides to tabs *16f*, ensuring that the projections on the sides match up with the folds on the front elevation to make the two overhangs; then glue tab *16e*.

Fig. 17

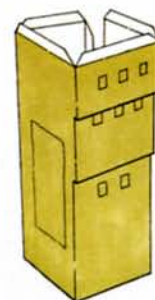
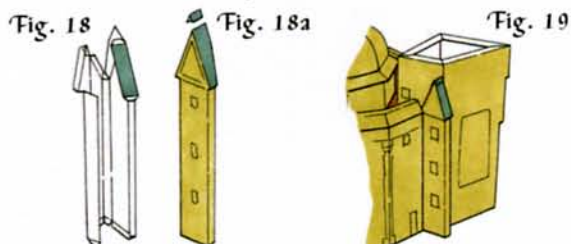

FIG. 18. On part 17 (small tower) glue tab *17a* under *17b* so that the folded edge is flush with the edge of *17b*.

FIG. 18A. Glue the roof sections using tabs *c* and glue part 18 (ridge tile) in place.

FIG. 19. Glue the main tower in position and then the small tower (part 17), tucking in tab *17d* so that it fixes to part 6 (roof terrace).



Main tower roof

FIG. 20. Glue parts 20 and 21 to part 19, also gluing the folded edges (spine) of 20 and 21 together. Fold tabs on part 19 upwards. This will form a support for the other roof sections.

FIG. 20A. Glue parts 26 and 27 to the supports, applying glue to the outer edges of 20 and 21 as well as to the tab on part 19. Make sure the top of each roof section is level with the top of the supports: when glued you should have an overhang where the roof sections meet the base of the support. Fold the tabs on parts 26 and 27 over to provide a support for parts 28 and 29.

FIG. 20B. Glue parts 28 and 29 in place using the tabs of 26 and 27 as well as the tabs on the base part 19. Then glue on the ridge tiles (parts 22–25), as indicated in the diagram, with the more pointed end towards the apex. Lastly, assemble and glue on the capping stone (part 30).

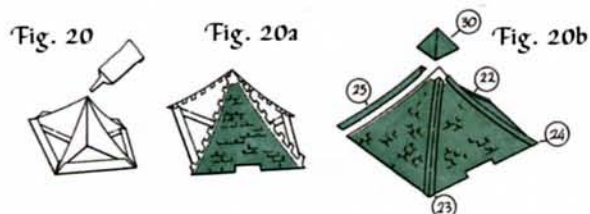

Buttresses

FIG. 21. On parts 38, 39 and 40 glue tab *a* to the opposite side, ensuring that the folded edge of tab *a* is flush with the edge of the side panel.

FIG. 21A. Glue the base to tabs *b*, then the front and sloping lower section to tabs *c*, and finally the sloping top to tabs *d*.

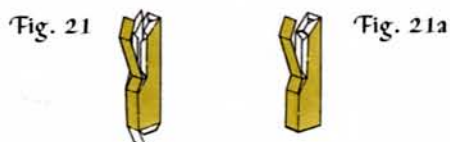

Final stage

FIG. 22. Assemble the two parts of the chimney (parts 31 and 32) but keep them separate. Glue part 31 to part 6 and the main tower. Glue the roof to the main tower so that the slot in the roof edge accommodates the chimney. Glue the top of the chimney (part 32) to the stack (part 31), then the buttresses to the wall and finally the assembled weather vane to the top of the dome, aligning the ribs on the base of the weather vane (part 33) with the ribs of the dome.

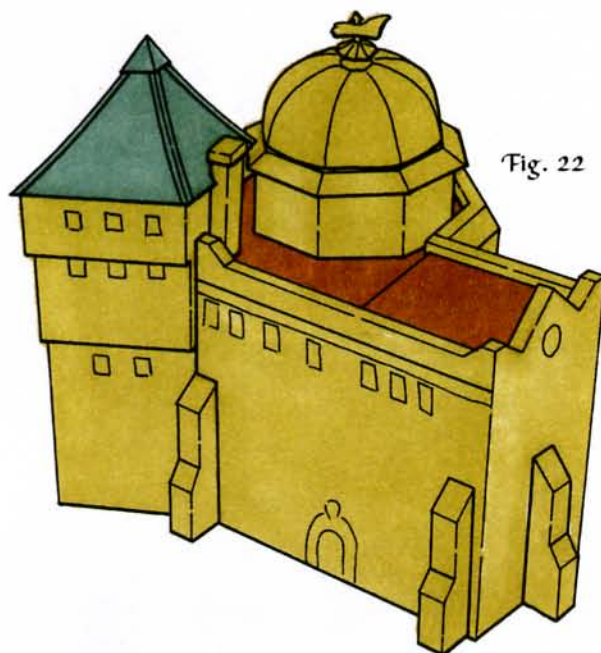

THESE BE

THE BOAT HOUSE

FIG. 1. Fold tabs *1b*, *c* and *d* of **part 1** upwards and glue the bottom of the walls as shown, gluing the last section of wall to tab *a* (see FIG. 2).

FIG. 3. Glue the roof (**part 2**) so that the more decorative gables are on the side with the larger doors, and then fix the whole assembly to the floor plan.

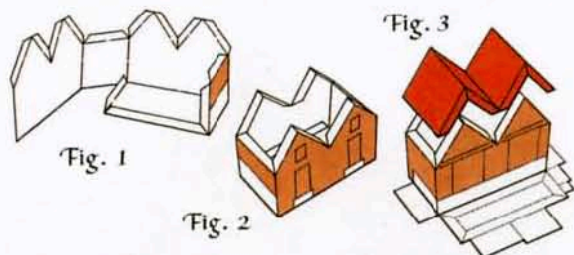

FIG. 4. Assemble **parts 3, 5** and **6** by gluing the sides to tabs *a* and *b*.

FIG. 5. Assemble **part 4** by gluing the triangular sides to tabs *a*.

FIG. 6. Assemble **parts 8, 9** and **10** by gluing tab *a* to the opposite face and then the sides to tabs *b*.

FIG. 6A. Assemble **part 11** by the same method.

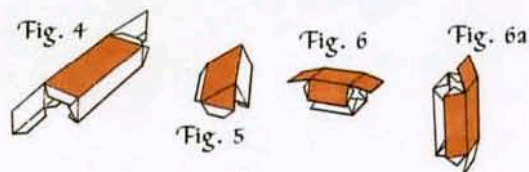
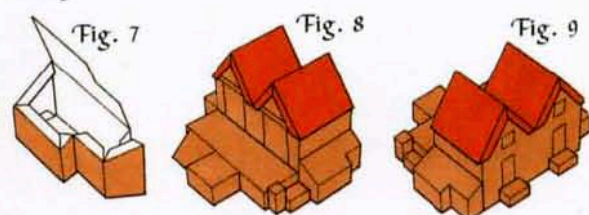

FIG. 7. Glue the bottom of the wall sections of **part 7** to tabs *b-f* on the base, and to tab *a*, where the walls meet. Glue the roof to tabs *g*.

FIGS 8, 9. Glue **parts 3, 4, 5, 6, 7, 8, 9, 10** and **11** into position.



The boats

FIG. 10. Fold **parts 12a, 12b** and **12c**.

FIG. 10A. Glue **parts 12a** and **12b** to **part 12c**, to form the hull.

FIG. 10B. When the glue has set, open up the hull to accommodate **part 12**.

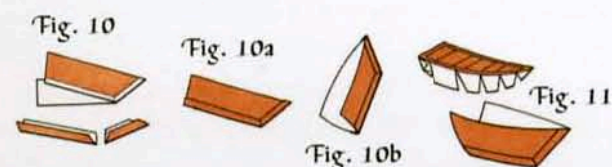
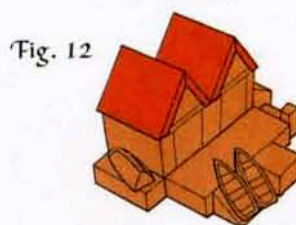

FIG. 11. Fold down the tabs and stern of **part 12**. Apply glue to the inside of the hull along the top and back edges of **part 12c**. Slide **part 12** into the hull, ensuring all the tabs are on the inside, and press down gently. Repeat the procedure for **parts 13** and **14**.

FIG. 12. Glue the boats in place as shown.



MODO'S GARDEN SHED

FIG. 1. Draw three lines on the reverse of **part 1** as shown.

FIG. 2. Assemble **part 1** by gluing tab *a* so that the folded edge is level with the right hand line you've just drawn and, as it continues upwards, level with the outside edge of the tower.

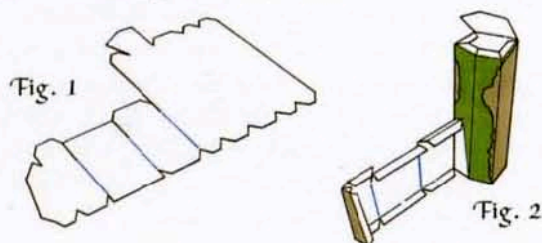

FIG. 3. Glue tabs *1d-1l* to the floor plan. Start with the tabs on the base of the tower (*1d-1b*), making sure that they sit exactly on the locations marked. Use a pen or lolly stick to manoeuvre the tabs from the inside if you have difficulty. Once you're satisfied that all the tabs are in the correct position, glue the top of the tower to tabs *b*.

FIG. 4. Glue **parts 2, 3** and **4** (wall supports) into position using the floor plan and the remaining two lines you drew as guides. Glue the areas on **part 1** marked '**part 17**' and '**part 18**' to tabs *d* on the supports.

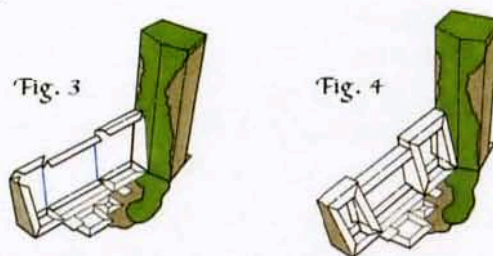

FIG. 5. Glue **part 5** in place, ensuring that the base tabs *a, b* and *c* are located correctly before fixing the main face of **part 5** to tabs *c* on the wall supports and wall top. Make sure that the middle section of the wall top, marked '**part 16**', is flush with the top of the middle dropped section of **part 5**.

FIG. 6. Assemble parts 7 and 8 (chimney), and part 6 (buttress) and glue into position.

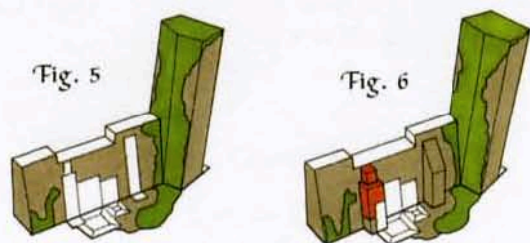

FIG. 7. Glue part 9 into position using the areas marked on the floor plan and part 7 as a guide.

FIG. 8. Assemble part 10 by gluing tab *a* to the opposite side, then the roof to tabs *b*, and fix into position as marked. Glue the larger roof (part 11) to part 9, making sure tab *a* is folded and glued to the chimney.

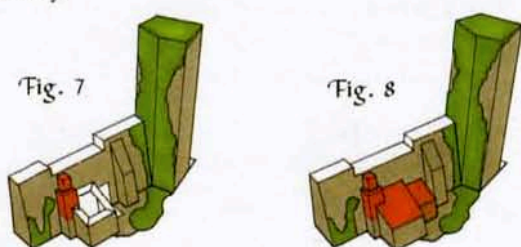
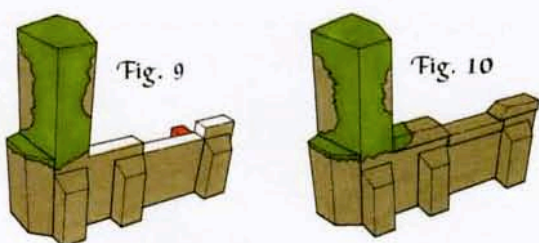

FIG. 9. Assemble the outer buttresses (parts 13, 14 and 15) by gluing the bottom of the sides to the base tabs *b* and the side panel edge to tab *a* and finally the sloping tops to tabs *c*. Assemble part 12 by gluing tab *a* to the opposite side and then the top to tabs *b*. Glue parts 12, 13, 14 and 15 into position.

FIG. 10. Assemble the parapets (parts 16, 17 and 18). First glue tabs *a* to form the ends. Glue the side panel to tab *b* and finally, on parts 17 and 18 glue the sloping ends to tabs *c*. Glue part 16 into position first, then 17 and 18.



THE RIVER WALL

FIG. 1. Roll part 1 to form a tube. Glue part 2 to the inside of one end of part 1 so that the edge of part 1 is level with the central dotted line. Glue the other end of part 1 to the remaining half of part 2 so that the two ends butt up to each other forming a flush finish on the outside of the tube.

FIG. 2. Fold the tabs on parts 3 and 4. Apply glue to the inside of the top edge of the tube and push part 3 part-way into the open end, making sure that all tabs are on the inside. To get a flush finish turn the assemblage over, place on a flat surface and gently

push the tube down onto part 3. Repeat the process for part 4 (see FIG. 2A).

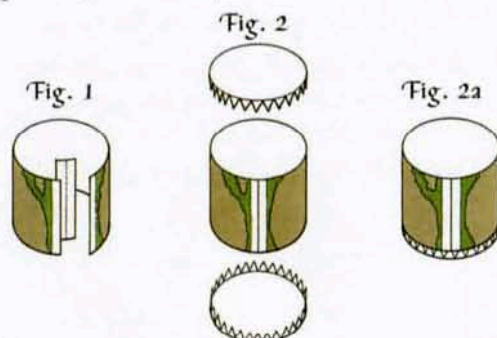

FIG. 3. Assemble part 6, gluing tab *a* in place. Fold back all tabs on part 5 and glue part 6 to part 5 to form the roof.

FIG. 4. Glue the assembled roof to part 1.

FIG. 5. Assemble the wall (part 7) by gluing tab *a* to the inside bottom edge of the opposite wall face. Glue the end to tabs *b*.

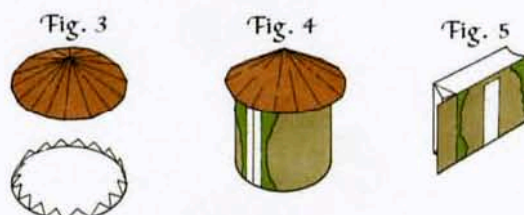
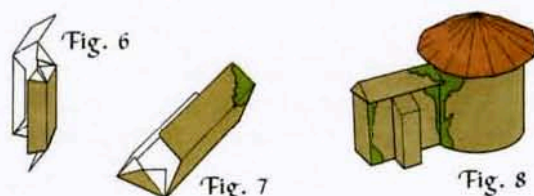

FIG. 6. Assemble the buttress (part 8) by gluing tab *a* to the opposite side panel, then the base to tabs *b* and the top to tabs *c*.

FIG. 7. Assemble part 9 by gluing the sloping top panels to end tabs *b* and tab *a*.

FIG. 8. Glue parts 7, 8 and 9 into position as shown, so that tabs *c* on parts 7 and 9 are glued to the round wall of part 1 at the point where the two joined ends meet.



THE WALL OF NAMES

FIG. 1. Glue tab *a* of part 1 to the inside of the top of the opposite wall face. Glue the flat end to tabs *b*.

FIG. 2. Curve the other end so that when it is glued to tabs *c* you have a concave face that will fit the curve of the River Wall tower.

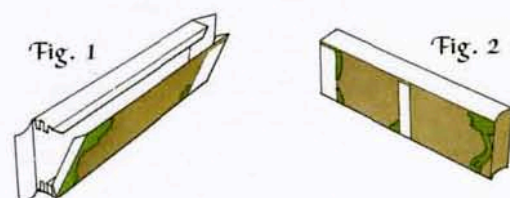

FIGS 3, 3A. Assemble the buttresses (parts 2, 3, 4 and 5) by gluing tab *a* to the opposite side panel, then the base to tabs *b* and top to tabs *c*.

FIG. 4. Assemble part 6 by gluing the top two surfaces to end tabs *b* and side tab *a*, forming a long triangular shape. Bend the end with tabs *c* to form a concave triangular end. Tuck and glue tabs *c*.

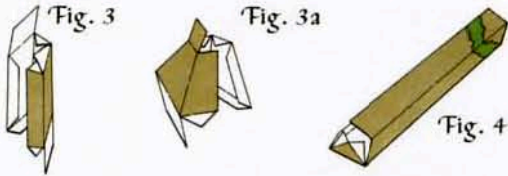
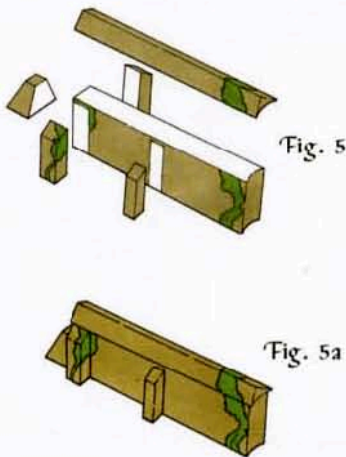

FIG. 5. Glue parts 2, 3, 4, 5 and 6 into position.



THE HIGH ENERGY MAGIC BUILDING

FIG. 1. Draw two lines on the reverse of part 1 and number them as shown.

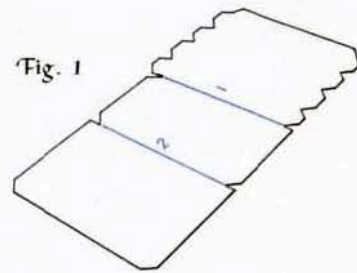

FIG. 2. Glue tab *g* so that the folded edge is level with line 1, forming a tower section. Then glue part 1 to the floor plan.

FIG. 3. Glue part 2 to the floor plan, ensuring that tab *2e* is glued to the tower section and tab *2d* is glued to the straight wall with the folded edge level with line 2. Then glue part 3 in position as shown.

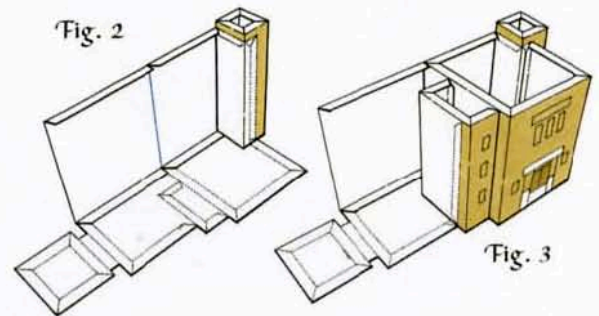

FIG. 4. Assemble part 5 by gluing tab *e* to the opposite end. Glue parts 4 and 5 in position as shown, ensuring that the folded edge of tab *4a* is flush with the end of part 1.

FIG. 5. Assemble part 6 by gluing tab *a* to the other end panel, and glue into position. It is best to do this on a flat surface.

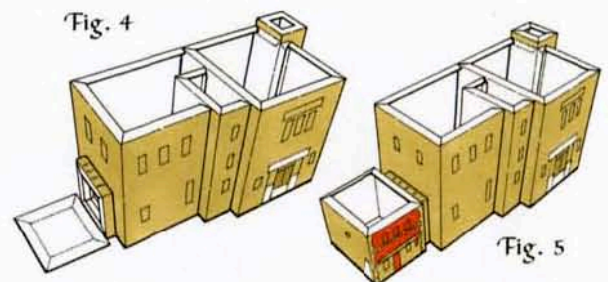

FIG. 6. Glue part 7 (roof terrace) into position, ensuring that tabs *a* and *b* are glued to the tower section of part 1. Assemble part 8 (roof) by gluing tabs *a* to the adjacent roof section. Angle the tabs on part 6 upwards to match the slope of the roof. Glue part 8 onto part 6 as shown. Fold down the eaves boards (bottom wooden sections of roof) and spot glue them to the walls to prevent them flapping up.

FIG. 7. If you wish, add ridge tiles, parts 9–13, as shown.

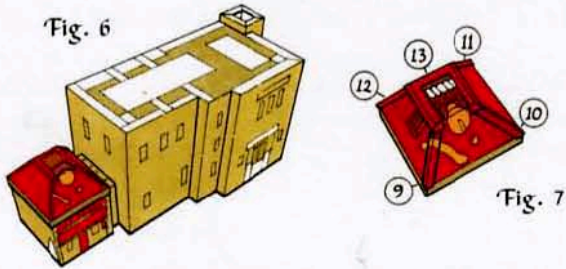

FIG. 8. Assemble part 14 (flat roof of tower) as shown. Assemble part 15 by gluing the sloping roof to tabs *a*.

FIG. 8A. Glue part 14 into position so that it is flush with the side of the tower that faces the roof terrace. Fix part 15 in position, applying glue to the lower part of the door as well as to tabs *b*.



FIG. 9. Cut the eight segments at the centre of part 18 so that you have eight triangular tabs.

FIG. 9A. Assemble parts 16, 17, 18, 19 and 20 by gluing tabs *a* on the end panels to the side panels. Glue parts 17 and 18 to part 16. Assemble part 21 by gluing tab *a* to the opposite face and then the triangular ends to tabs *b*. Glue part 20 to part 19 and part 21 to part 20, matching the base tab letters to the location areas.



Parapet assembly

FIG. 10. Assemble parts 22, 23 and 24 by gluing the sloping top panels to end tabs *a*, then *b* and *c*.

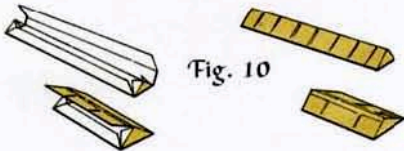

FIG. 11. Assemble parts 25, 26 and 27 by gluing tabs *a* to the opposite panel and then the ends to tabs *b*.

FIG. 12. Assemble parts 28 and 29 by gluing tabs *a* to the base then the sloping tops to tabs *b*.

FIG. 13. Assemble parts 30–33 (wooden beams) by gluing tab *a* to the opposite face and then the ends to tabs *b*.

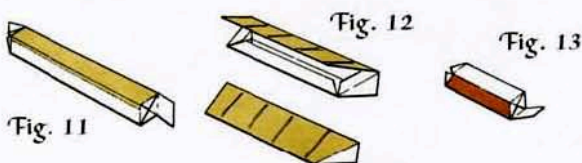

FIG. 14. Assemble part 34 (platform) as shown and part 35 (winch) by gluing the sloping top to tabs *a*.

FIG. 14A. Glue part 35 to part 34.

FIG. 15. Assemble parts 36 and 37 (chimneys) by gluing tab *a* to the opposite face and then the top to tabs *b*.



The spheres

FIG. 16. Glue part 38 (flange) to part 42 so that the base tabs are fixed to the segment indicated.

FIGS 17, 17A. Glue part 39 to the opposite segment indicated, also gluing the folded edge so that 38 and 39 are glued together.



FIG. 18. Repeat the process for parts 40 and 41.

FIG. 18A. Repeat the process for parts 43–47.

FIG. 19. Fold the tabs on part 47 up and down alternately then glue the two octagonal bases together.

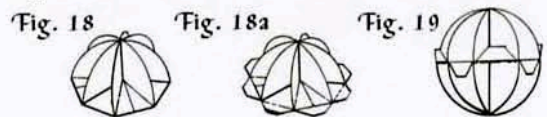

FIG. 20. Apply glue to the rim of two adjacent flanges from top to bottom and to the central points where the flanges join.

FIG. 20A. Fix part 58 to the two rims, making sure that the two octagonal tabs are central at the top and bottom of the sphere.

FIG. 21. Fix part 59 in place on the opposite segment, applying glue to the flange rims as before, and gluing top and bottom to the octagonal tabs of part 58.

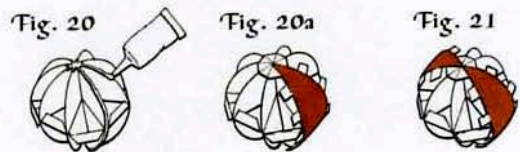

FIG. 22. Repeat for parts 60 and 61, so that you have alternate segments fixed.

FIG. 23. Glue parts 62–65 in place to complete the sphere, using the tabs on the adjacent segments. Repeat the process for parts 48–57 and 66–73 to form a second sphere.

FIG. 24. Assemble **part 74** by gluing tab *a* to the opposite panel to form an octagon. Tuck tabs *b* inwards a little, and glue to the base of one of the spheres, ensuring it is as level as possible.



FIG. 25. Assemble **part 75** (wood stack) by gluing the triangular sides to base tabs *a*, then glue to the main building using tabs *b*.

FIG. 26. Assemble **parts 77 and 78** by gluing tab *a* to the base, then tabs *b* to the opposite walls, the tops to tabs *c* and the lower front panel to tabs *d*.

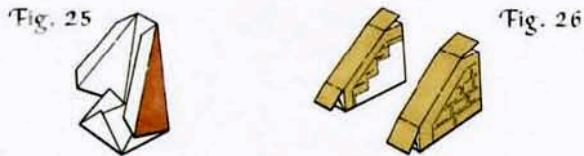

FIGS 27, 27A. Assemble **part 76** (steps). Pre-fold the steps as shown, then glue tabs *a* to the back panel and tabs *b* to the base. Glue the tread sections of the steps to tabs *c* and finally to tab *d* and the two small triangular tabs.

FIG. 28. Assemble **part 79** by gluing tab *a* to the opposite panel, then glue the ends to tabs *b*.

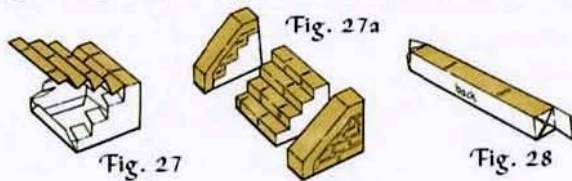
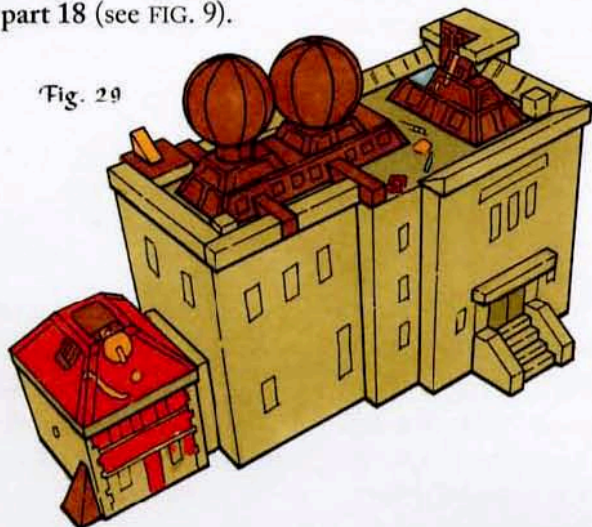

FIG. 29. Glue all parts into position using the location areas marked. When gluing the parapets, beams and platform it is best to start with **part 22** and work your way round the edge of the building. The parapets will overhang slightly and should be positioned so that the arrow marked on the base as a guide points towards the outside edge of the building. Glue the sphere with the support to **part 17** and the plain sphere to the tabs that you cut on **part 18** (see FIG. 9).



THE OBSERVATORY

FIG. 1. Make sure that all the necessary guidelines are drawn in and numbered on the reverse side of **part 1**, and on **parts 3, 5, 6, 7, 9, 12 and 144** (see page 2 instructions).

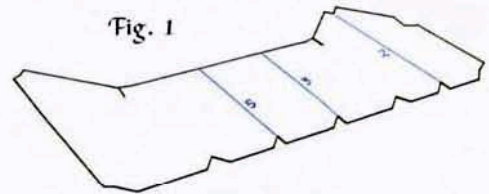

FIG. 2. Glue **part 1** to the floor plan.

FIG. 3. Glue **parts 2 and 3** to the floor plan and **part 1**, aligning tabs *2c* and *3d* with lines 2 and 3 respectively.

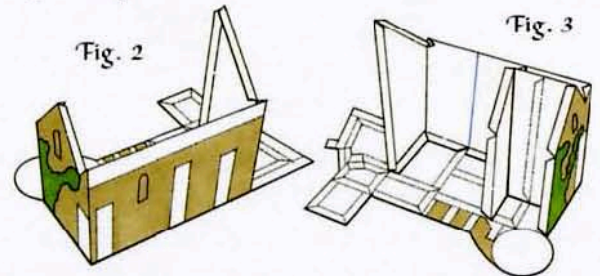

FIG. 4. Glue **parts 4 and 5** in position as shown.

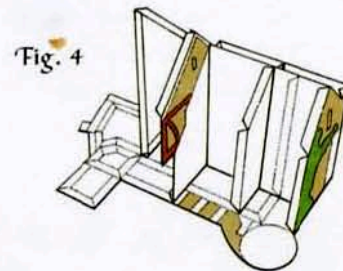
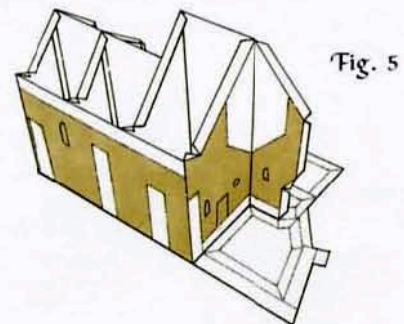

FIG. 5. Glue **part 6** in position as shown.



FIGS 6, 6A. Glue **part 7** in position, making sure you fold down the caves section and glue the small triangular tab and tab *f* to **part 6** as shown in FIG 6A.

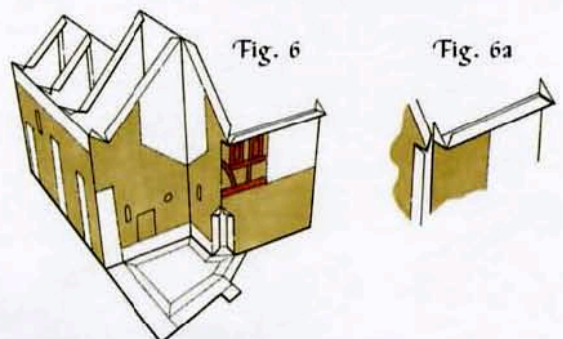
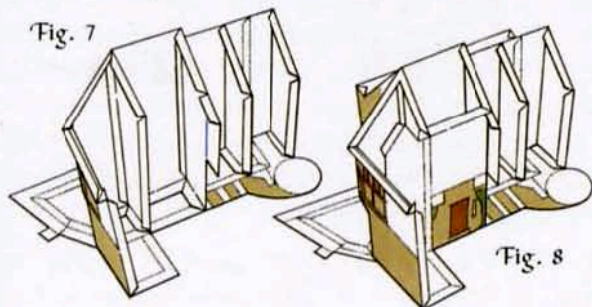

FIG. 7. Glue **part 8** in position as shown.

FIG. 8. Glue **part 9** in position as shown.



FIGS 9, 9A. Assemble **part 10** by gluing the angled lower front panel to tabs *a*, then glue into position.

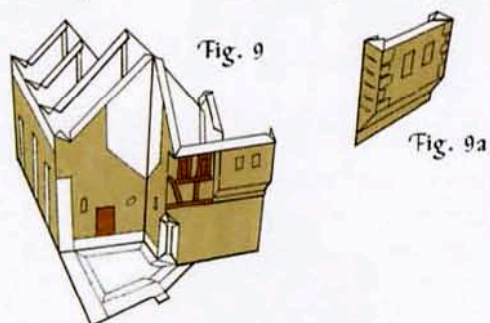

FIG. 10. Glue **part 11** in position, ensuring that the top section is glued to tab *10d* and the triangular tab on the eaves as well as to *7c*; then glue in **part 12** as shown.

FIG. 11. Glue **part 13** in place as shown, following the location mark on **part 5**.

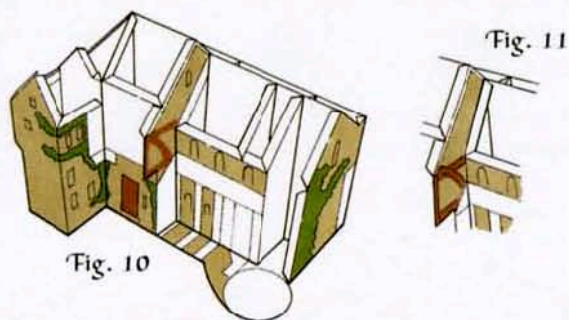

FIG. 12. Glue **parts 14** and **15** in position as shown.

FIG. 13. Glue on **part 16** (main roof). Fold down and glue the gable ends (including the half-gable that comes over **part 15**) and the stone parapet that runs along the top of **part 1**.

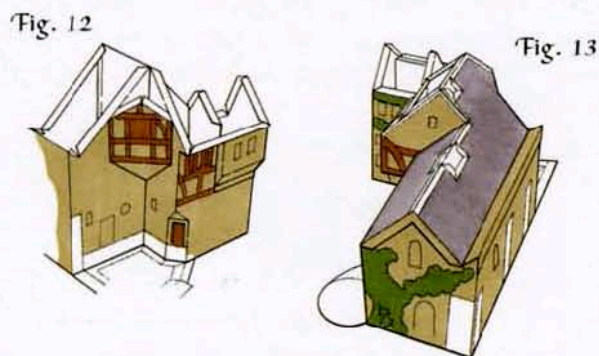

FIG. 14. Glue on **part 17** as shown, folding and gluing the gable as before.

FIGS 15, 15A. Assemble **part 18** by gluing the base to tabs *18a*, then fix into position by applying glue first to tab *18b* and then to the area marked *18c* in red on the left hand wall and the reverse of the jutting-out section of **part 5**.

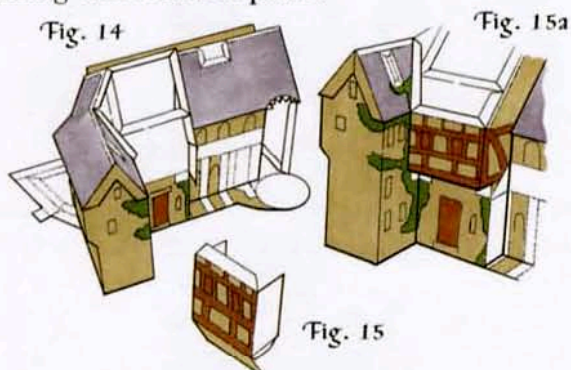

FIG. 16. Glue on **part 19** as shown.

FIGS 17, 17A. Assemble **parts 20–23** as shown, then glue into position in numerical order. Apply glue to the reverse of the side panel of **part 23** as well as to the tabs.

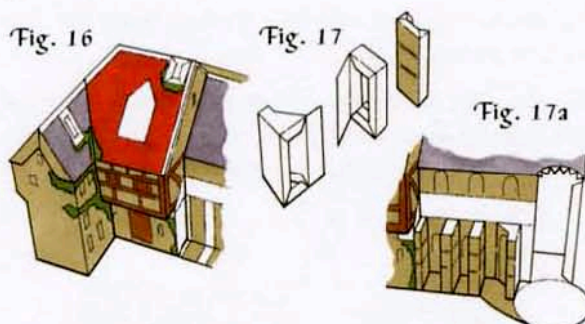

FIG. 18. Glue on **part 24**, using the location guides on **parts 20–23**, and fold back the tabs marked *25* in red. Assemble **part 25** (roof) by gluing the back panel to tab *a* and the roof section to tabs *b*, then glue into position.

FIG. 18A. Assemble **parts 27** and **28** by gluing tab *a* to the top of the angled front panel and then the sides to tabs *b*. Glue both into position under the overhang of **part 18**.

FIG. 19. Glue **part 26** in position as shown.

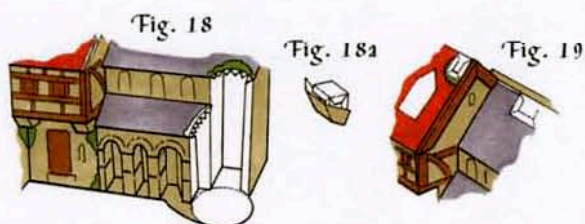

FIG. 20. Assemble **part 29** (dormer window) by gluing the sides to tabs *a*. Glue into position on the roof (**part 19**), then glue the dormer roof (**part 30**) to tabs *b*, fold down and glue the gable bargeboards, and lastly glue on the ridge (**part 31**).

FIG. 21. Assemble the chimneys (parts 32, 33 and 42). Fix part 33 to part 32.

FIGS 22, 22A. Assemble parts 34–41 as shown.

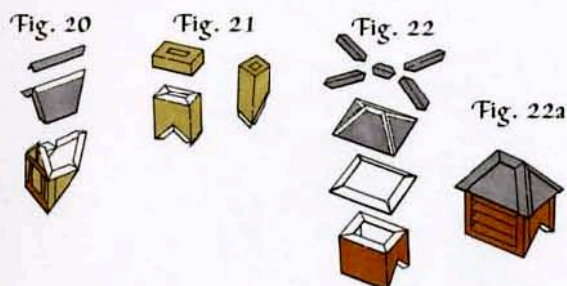

FIG. 23. Glue the assembled parts into position, then add the ridge tiles (parts 43–48) as indicated.

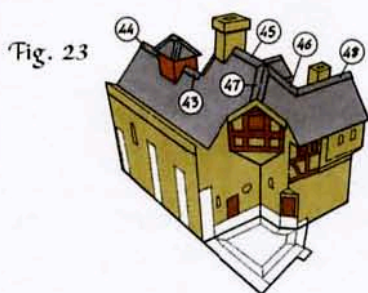

FIG. 24. Glue part 49 as shown, following the location guides on the floor plan.

FIG. 25. Assemble part 51 by gluing tab *a* to the back panel. Glue part 50 in position, folding down and gluing the front of the step. Glue part 51 in position.

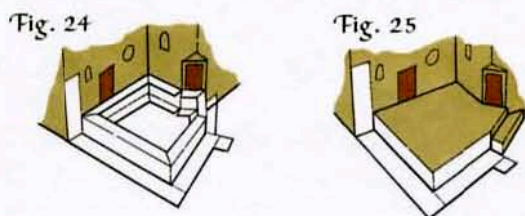

FIG. 26. Assemble part 52 by gluing the base to tabs *a*, the top to tabs *b* and the inside wall to tabs *c*.

FIG. 26A. Assemble part 53: glue the walls to base tabs *a*, tuck and glue end tab *b* then glue the sloping top to tabs *c*.

FIG. 26B. Assemble part 54 by gluing base tab *a* to the underside of the opposite panel and the ends to tabs *b* and *c*.

FIG. 26C. Assemble part 55 by gluing tab *a* to the opposite face, the base to tabs *b* and the top to tabs *c*.

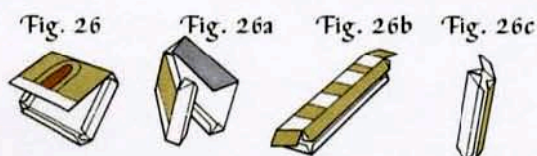

FIG. 27. Glue parts 52–55 in position.

FIG. 28. Assemble parts 56–59 by gluing base tab *a* to the inside of the angled front panel, then the sides to tabs *b*.

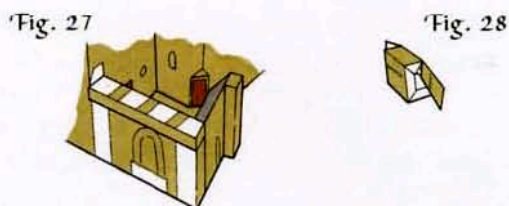

FIG. 29. Assemble parts 60–67 by gluing the side and back panel to base tabs *a*, the other side to tabs *b* and the top to tabs *c*.

FIG. 30. Assemble part 68 (steps) by gluing the sides to base tabs *a*, then the tread sections to tabs *b*, and finally the bottom riser to tabs *d*.

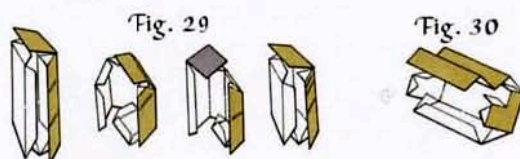
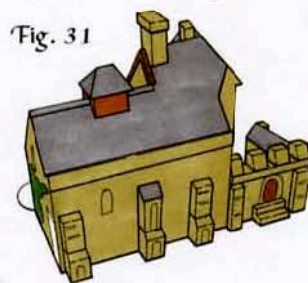

FIG. 31. Glue parts 56–68 in position as shown.



The tower

FIG. 32. Glue part 70 to part 69 as shown.

FIGS 32A, 32B. Glue part 71 to the opposite segment, applying glue to the folded edge as well as to the tabs so that parts 70 and 71 are glued together.

FIG. 32C. Glue on parts 72 and 73 in the same way. Repeat the process with parts 74–83.

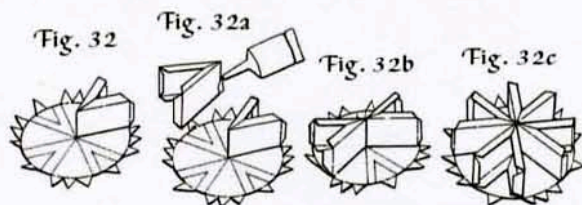

FIG. 33. Roll parts 87 and 91 (tower walls). Use something cylindrical like a kitchen roll holder, and roll the paper up tightly so that when it is released it stays naturally curved.

FIG. 33A. Roll parts 88 and 92. For these narrower pieces we suggest you roll them round a pencil; make sure you create the curve in the right direction (see illustration).

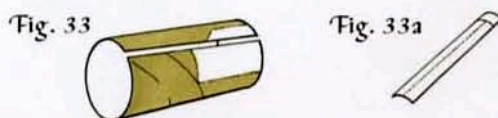

FIG. 34. Glue one side edge of part 87 to part 88, so that the edge of 87 is level with the central, vertical

dotted line on **88** and the top is level with the horizontal dotted line. The bottom edges should be flush. Glue the other end of the wall to the remaining half of **part 88** so that the two ends butt up to give a flush finish. To get the best results it is a good idea to use something tubular to put inside the tower when gluing the second edge of the wall so that you can press down on the join without crushing the tower wall (see FIG. 13 of the Tower of Art).

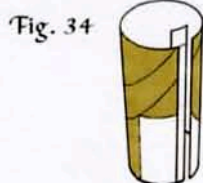

FIG. 35. Apply glue to the inside of the base of the tower and insert **part 90** so that the ends butt up either side of **part 88**. It is best to start at one end and work around the inside making sure that this stiffening ring is pressed firmly against the wall. This part should be flush with the bottom of the tower.

FIGS 35A, 35B. In the same way glue **part 89** inside the top of the tube, but this time insert only the lower half, so that the dotted line on **part 89** is level with the top edge of **part 87**, thus forming an inner sleeve.

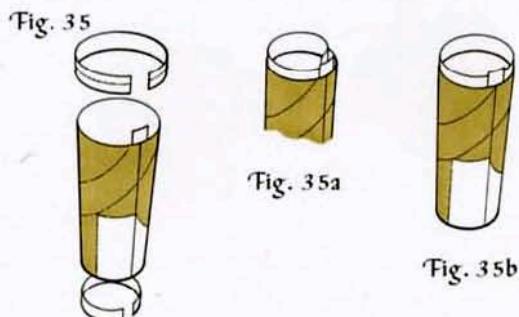

FIG. 36. Apply glue to the inside of the base of the tower and gently push in one of the assembled support frames, making sure that all the tabs are on the inside. Place the base on a flat surface and gently push the tower down until the support is flush with the bottom (see FIG. 36A).

FIG. 37. Apply glue to the exposed support tabs and the inside of the tower wall. Fix **part 84** as shown, ensuring all the triangular tabs are on the inside. Press down on a flat surface so that it is level with the bottom of the tower wall.

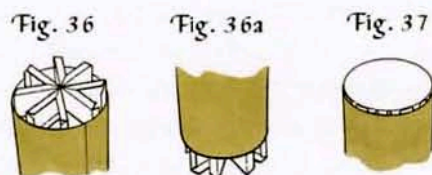

FIG. 38. Insert the second support frame into the top of the tube.

FIG. 39. This time push it down until it is approximately 5–7mm below the edge of the inner sleeve.

FIG. 40. Then glue **part 85** as shown. The bottom half of the tower is complete.

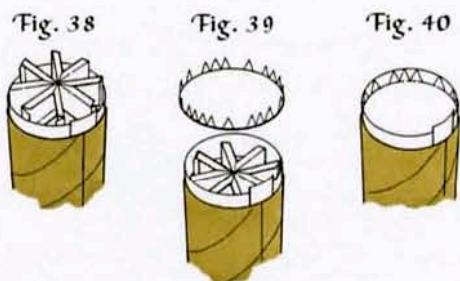

FIG. 41. Assemble the top half of the tower: glue **part 91** to **part 92** so that the two ends butt up flush at the dotted line, as before, except this time **part 92** should be flush with the top edge of **part 91**, leaving the bottom 10mm of the tower wall not fixed.

FIG. 42. Glue **part 93** inside the top edge, flush with the top.

FIG. 43. Apply glue to the inside top edge of the tower and gently push in the last support as you did for the base of the bottom half (FIGS 36, 36A).

FIG. 44. Glue in **part 86** so that it is flush as before (FIG. 37).

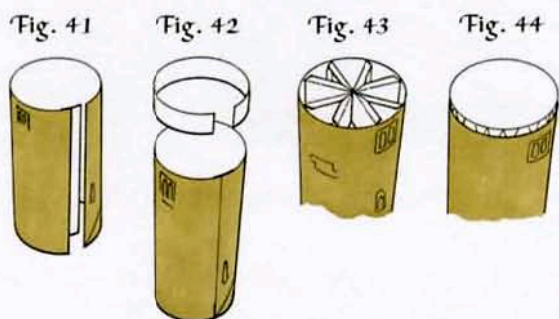

FIG. 45. When joining the two sections of tower, dry fit them a couple of times first (you may have to push the inner sleeve in a little), lining up the seams of the two sections. When you are confident it fits, apply a little glue to the inside of the bottom of the top half of the tower and slide it over the inner sleeve of the base section. Push down gently until the two sections meet. You can now glue the tower to the main building.

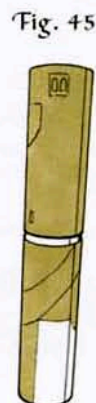
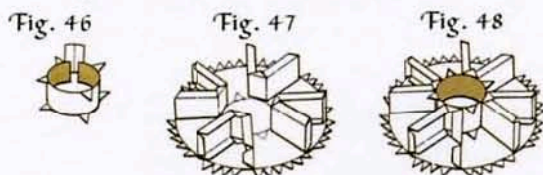

FIG. 46. Glue the two ends of **part 100** to **part 99** so that the printed surface is on the inside of the tube.

FIG. 47. Glue parts 95–98 to part 94 as shown.

FIG. 48. Glue part 100 into position as shown.



FIGS 49, 49A. Glue parts 102 and 103 as shown.

FIG. 50. Glue part 101 to the base of the support.

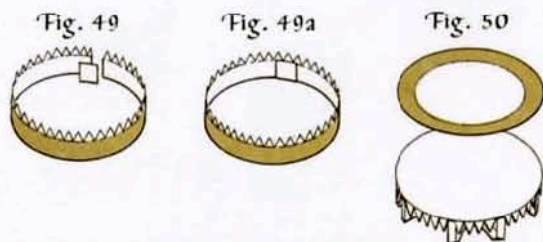

FIG. 51. Apply a little glue to the inside of part 103 and insert the support, gently pushing down until it is flush with the base of part 103. (You may find it wise to bend the triangular tabs on part 103 outwards a little before inserting the support, to keep them out of the way.)

FIG. 52. Fold the triangular tabs on part 103 inwards, apply glue to all tabs and fix part 104 as illustrated.

FIG. 53. Assemble parts 105–109 as for the tower supports (FIGS 32 to 32C).



FIG. 54. Glue part 110 to the bottom of part 105 as shown.

FIG. 55. Assemble parts 111 and 112 as before, glue in the support frame, then glue on part 113 (as in FIGS 51, 52). Make sure part 113 is aligned as shown in FIG. 63, with the location point for part 125 centred above the seam of part 112.

FIG. 56. Assemble parts 114 and 115 as shown. Fold the tabs on parts 116 and 117. Apply glue to the inner top edge of the tube and push in part 116 until flush. Fix part 117 to the base in the same way.

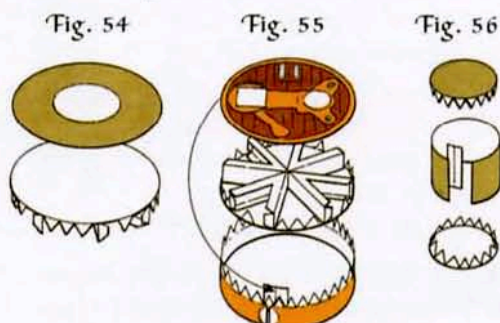

FIG. 57. Repeat the procedure with parts 118–121 (telescope stand).

FIG. 58. Glue assembled parts 114–117 to the base of 110, and part 123 (cog wheel) over the seam of part 112, as illustrated.

FIG. 59. Fold and glue part 122, then glue the circular base to the telescope stand (see FIG. 62).

FIG. 60. Fold and glue part 124.

FIG. 61. Assemble part 125 (chair) by gluing the sides to base tabs *a* then the folded sections to tabs *b*, *c*, *d* and *e*.

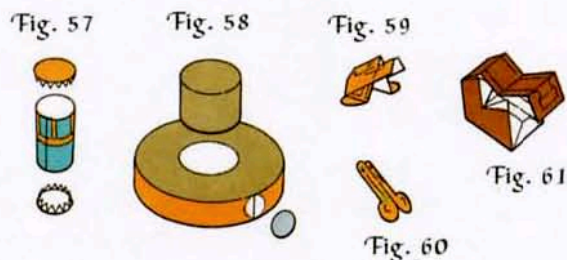

FIG. 62. Glue the assembled parts into position as shown.

FIG. 63. Glue the main disc to the top of the tower. Push the top disc into the central well of the main disc. You may leave this unglued, so that the telescope can be rotated.

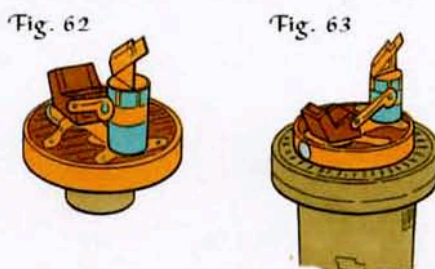

FIG. 64. Assemble parts 126–130 and 132–136 in the same way you did for the tower supports.

FIG. 65. Roll parts 138 and 139 to establish the curved shape. Glue the two ends of part 139 to part 138.

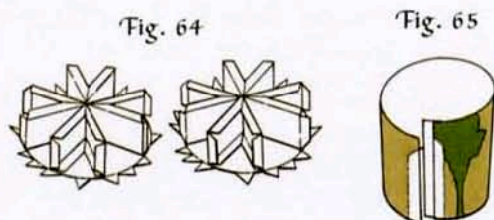

FIG. 66. As in FIG. 35, glue parts 140 and 141 inside the top and base so that they are level with the edge of the tube at either end.

FIGS 67, 67A. Apply glue to the inside of one end of the tube and gently push in one of the assembled supports until it is flush (as in FIG. 36).

Fig. 66



Fig. 67



Fig. 67a

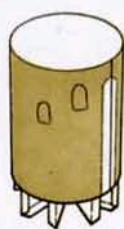

FIG. 68. Glue on part 131 as shown, ensuring all tabs are inside. Insert the second support frame into the other end of the tube and glue on part 137.

FIG. 69. Assemble the roof (part 143) by gluing the last segment to tab *a*.

FIG. 70. Glue part 142 to part 143, making sure it is as level as possible.

FIG. 71. Glue the assembled roof to the turret.

Fig. 68



Fig. 69

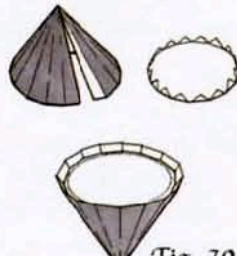

Fig. 71



Fig. 70

FIG. 72. Assemble part 144 (wall). Form the end buttress first by gluing the folded sections to base tabs *a* and then tab *b* to the line you've drawn on the reverse.

FIG. 72A. Apply glue to the location area for tab *c* and glue the bottom of the wall to tab *d*; tab *c* should then sit automatically in position.

FIG. 73. Assemble part 145 by gluing the sloping side and top to end tabs *a*, then the other sloping side to tabs *b*.

FIG. 74. Assemble part 146 by gluing the sides to base tabs *a* then the top to tabs *b, c, d* and *e*.

Fig. 72

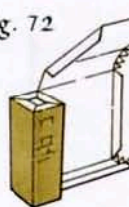

Fig. 72a

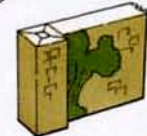

Fig. 74



Fig. 73

FIG. 75. Assemble part 147 by gluing the side and back to base tabs *a* then the other side to tabs *b* and the top to tabs *c*.

FIG. 76. Assemble part 148 by gluing the sides to base tabs *a*, then the folded sections to tabs *c*.

FIG. 77. Assemble the six barrels, parts 149–172, as shown.

Fig. 75



Fig. 76

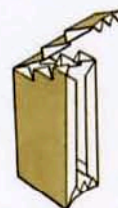

Fig. 77



FIG. 78. Glue all parts into position as illustrated.

FIG. 79. Suggested location for some barrels.

Fig. 78

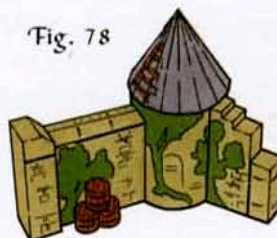
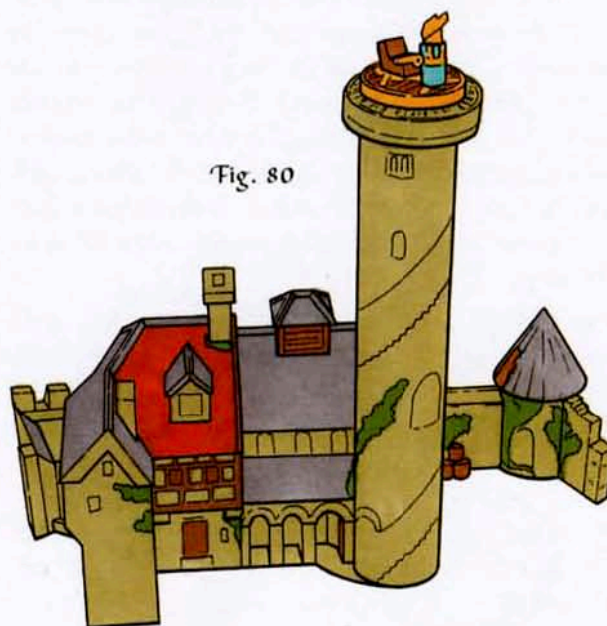

Fig. 79



FIG. 80. The completed Observatory.

Fig. 80



THE TOWER OF ART

The base

FIG. 1. Glue parts 2–8 to part 1, ensuring that parts 2–5 are glued together at the centre of the circular support.

FIG. 2. Assemble part 9. Fold the step section first, then glue the sides to base tabs *a* and *b*, then the tread sections of the steps to tabs *c*, and finally the bottom riser panel to tabs *d* and *e*.

FIG. 3. Glue parts 9 and 10 together.

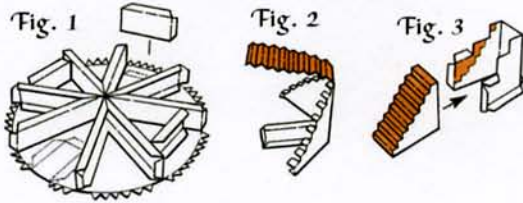

FIG. 4. Glue the assembled steps into position. Fold the triangular tabs around the base (part 1) upwards. Glue on part 11 (wall), starting at the steps (tab *a*); work round the circular support gluing the wall to the triangular tabs on the support base and the end tabs of the 'spokes'. Make sure the wall is tight to the support and flush with the base as you work round, finishing at the other tab *a* on the steps.

FIG. 5. Fold down the tabs at the top of the wall, apply glue to them and the 'spokes', to tabs *b* on the steps and tab *a* on part 12, then fix part 12 into position.

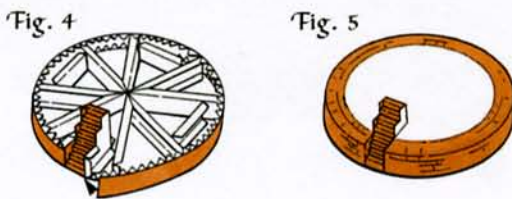
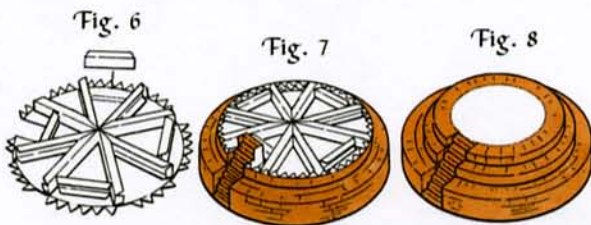

FIG. 6. Glue parts 14–21 to part 13 (repeating the process shown in FIG. 1), then glue on the wall (part 22), folding the end tabs *a* inwards.

FIG. 7. Glue the assembled support into position, fixing wall tabs *a* to the sides of the steps. Then glue on part 23 (top) as before (see FIG. 5), fixing tabs *a* to the side walls of the steps.

FIG. 8. Assemble the third tier (parts 24–33) in the same way and glue it into position. Glue on the top (part 34) as before, fixing tabs *a* to the top of the steps wall.



The tower walls

FIGS 9, 9A, 10. Assemble parts 35–39, ensuring that the 'spoke' supports are glued to each other at the centre of the circular support. Repeat the process with parts 40–54, creating four circular supports.

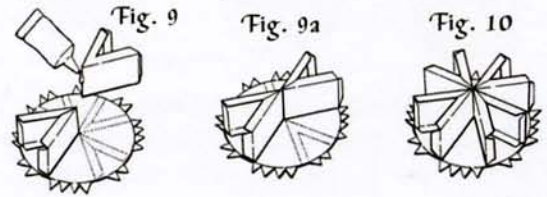
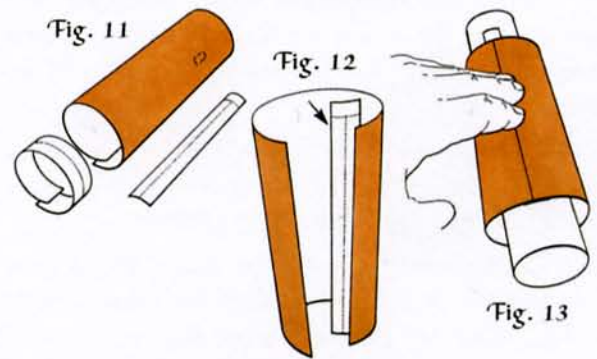

FIG. 11. Roll parts 59–68 as you did for the Observatory tower. (Parts 59, 60, 63, 64, 66 and 67 need to be rolled on the vertical axis; 61, 62, 65 and 68 on the horizontal axis.)

FIG. 12. Glue part 60 (vertical tab) to one end of part 59 (wall). Make sure that the top edge of the wall is level with the horizontal dotted line and the side edge is level with the vertical dotted line on the tab.

FIG. 13. Glue the other end of the wall to the remaining half of the tab so that the two wall ends butt up. This is where the inner card tube of a kitchen roll, or something similar, will be of use. Place the tube inside the tower wall and press down gently on the seam until the glue has set.



FIGS 14, 14A, 14B. Glue parts 61 and 62 to the inside of the tower so that the ends butt up either side of the vertical tab. Part 61 should be glued so that the dotted line is level with the top edge of the wall (see FIG. 14A). Part 62 should be completely inside the base of the wall so that the bottom edges are level (see FIG. 14B).

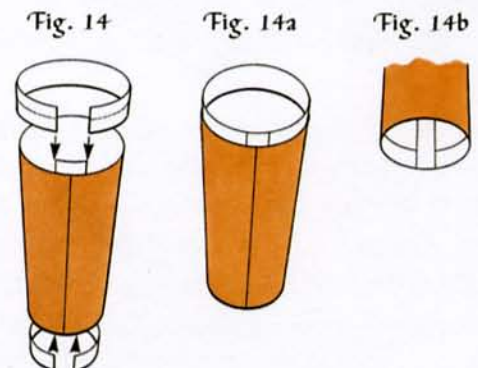

FIG. 15. Repeat the process with parts 63 and 64 (middle section wall). This time the vertical tab (part 64) will be 10mm short of the bottom of the wall.

FIG. 16. Glue part 65 inside the top of the section so that the dotted line is level with the top edge of the wall.

FIG. 17. Assemble parts 66 and 67 (top section wall) in the same way. This time the top of the vertical tab will be level with the top of the wall and 10mm short of the bottom. Glue part 68 inside the top of the wall so that the two top edges are flush.

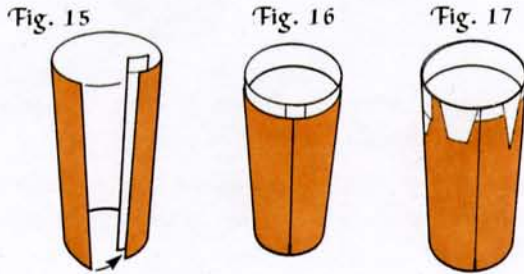

FIG. 18. Apply glue to the inside of the base of the bottom section of the tower and gently push in one of the circular supports, ensuring that all tabs are inside.

FIG. 19. To make sure it is flush with the base, place the support and tower on a flat surface and gently push the tower down onto the support until it touches the surface.

FIG. 20. The support should now be in position at the base as illustrated.

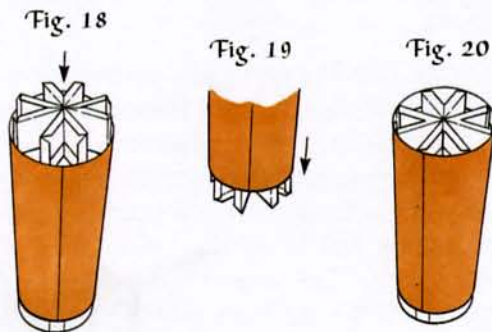

FIG. 21. Apply a little glue to the inside of the base and the exposed tabs of the support. Fix in part 55 as shown, making sure all tabs are inside the wall.

FIG. 22. Apply glue to the inside top edge of this section of the tower and push in another support as before, but this time it should be about 5-7mm below the top edge of the inner sleeve.

FIG. 22A. Apply glue to the exposed tabs of the support and to the tabs of part 56 and fix as shown. Repeat the process in FIGS 22 and 22A for the top of the middle section of the tower using the third circular support and part 57.

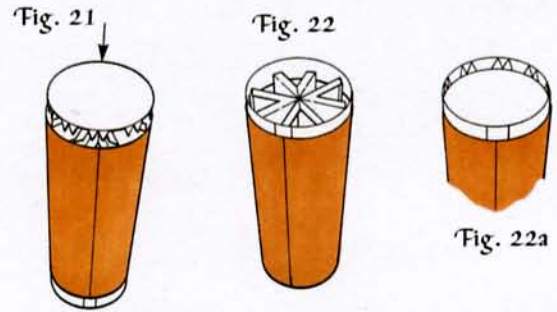

FIG. 23. Apply glue to the inside top edge of the top section of tower and push in the last support so that it is flush with the top edge of the section.

FIG. 24. Glue part 58 to the top as shown, making sure all tabs are inside.

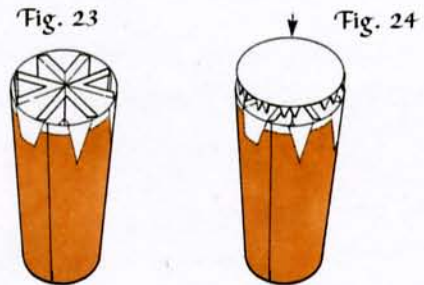
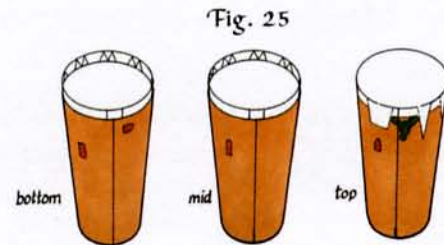
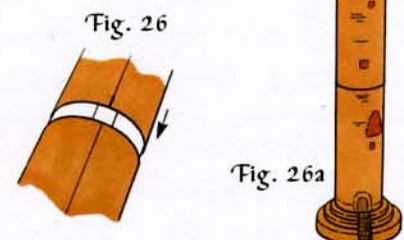

FIG. 25. The three sections of the tower should now look like this.



FIGS 26, 26A. Before gluing the sections together, dry fit them first. You may have to squeeze the inner sleeves a little. Once you're confident of achieving a good fit, glue the bottom section of the tower to the tower base, lining up the door with the steps. Then apply a little glue to the inside bottom edge of the middle section and slide it over the inner sleeve of the bottom section - remember to line up the vertical seams. At this point you could glue on the top section using the same method; however you may want to wait until you've assembled all the turrets, or leave the top section detachable (in which case remember to pick the assembled tower up by the bottom section).



The turrets

FIG. 27. Turret 1. Glue parts 70 and 71 to part 69 as shown, remembering also to glue them together where the folds meet.

FIG. 27A. Glue part 72 (wall) to the assembled support.

FIG. 28. Glue part 73 to the base as shown.

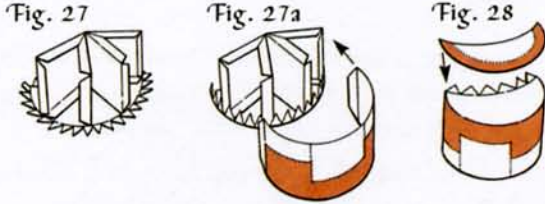

FIG. 29. Glue on the top, part 74, as shown.

FIG. 30. Fold and glue parts 76 and 77.

FIG. 31. Cut out the white rectangles, to create a castellated parapet.

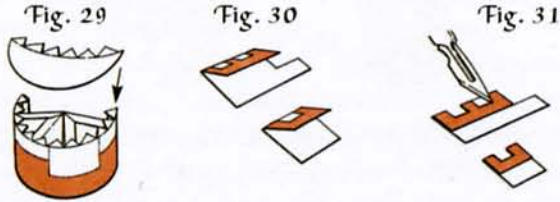

FIG. 32. Glue turret 1 into position.

FIG. 33. Glue parts 75–77 in position. When fixing on the parapets, glue the white section only (i.e. where the reverse side is exposed), and make sure that the bottom edge of the printed area on the inner face is level with the floor (part 75).

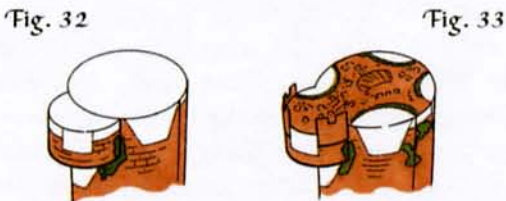

FIG. 34. Turret 2. Assemble part 82 by gluing tab *a* to the inside of the opposite face, forming an octagonal tube. Glue part 82 to part 81.



FIG. 35. Use part 84 to join the two ends of part 83.

FIG. 36. Apply a little glue to the inside top edge of part 83 and push in the octagonal support from the bottom until it is level with the top edge.

FIG. 37. Glue on part 85 (base), making sure that all tabs are inside the wall.

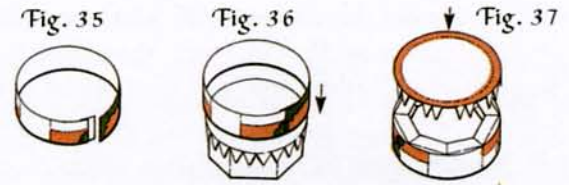

FIG. 38. Glue on part 86 (top).

FIG. 39. Assemble the parapets (parts 87 and 88) as in FIGS 30 and 31, and glue into position.

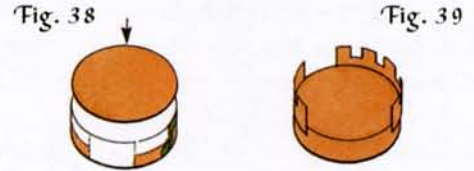

FIG. 40. Turret supports 1 and 2. Glue tabs *a* on part 78 to the inside top edge of part 79.

FIG. 41. Glue part 80 to the inside bottom edge of part 79 as shown. Repeat the process with parts 89–91.

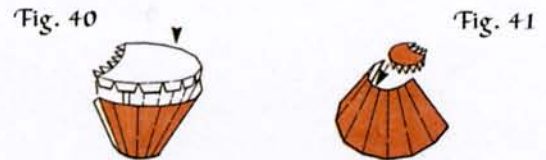

FIG. 42. Turret 3. Draw a line on the reverse of part 93 as shown.

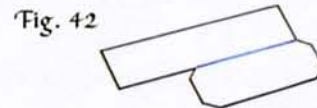

FIG. 43. Join the ends of part 93 using the vertical tab part 92, as shown.

FIGS 44, 45. Dry fit part 94 into the tube: you may find it easier to slide it down from the top, rather than pushing it in from the bottom the way it is shown in the diagram. Once you are satisfied with the fit, apply a little glue to the inside of part 93 just above the line and along the inside edge of the cutaway section. Glue in part 94 so that it is level with the line and edge. Next glue in part 96 (base) as shown.



FIG. 46. Apply glue to the inside top edge of the turret and fix in part 95, making sure all tabs are inside.

FIG. 47. Assemble part 98 and glue to the reverse side of the base (part 97).

FIG. 48. Glue on part 98 (top) as shown.

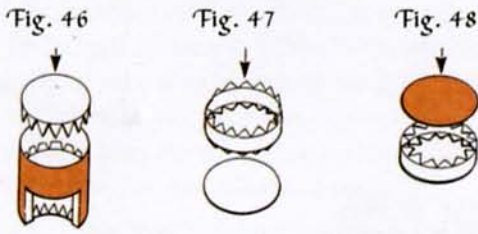

FIG. 49. Fold and glue the parapet, part 101.

FIG. 50. Glue one half of part 100 to part 101 as illustrated.

FIG. 51. Cut out the white rectangles.

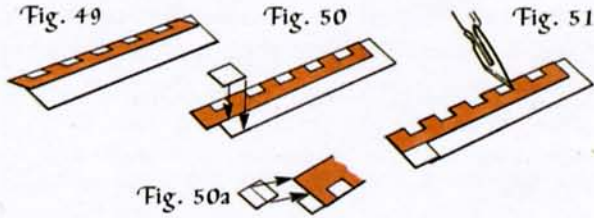
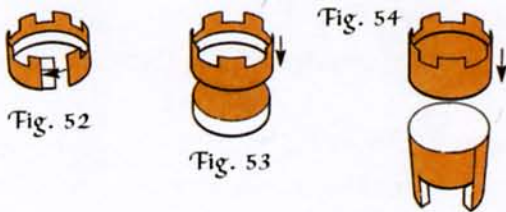

FIG. 52. Glue the two ends together to form a circular wall.

FIG. 53. Apply a small amount of glue to the inside of the parapet wall below the printed edge and insert the assembled circular floor (parts 97-99) so that the top of the floor is level with the bottom edge of the printed area.

FIG. 54. Glue the two parts of Turret 3 together. Assemble Turret 4 (parts 102-111) by the same method.



FIGS 55, 55A. Turret 5. Glue parts 113 and 114 to part 112 as illustrated.



FIG. 56. Glue part 116 to the reverse side of part 115.

FIG. 57. Glue part 117 to parts 115 and 116.

FIG. 58. Glue on part 118 (top) as shown.

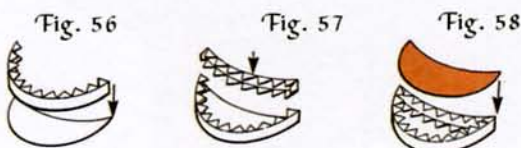
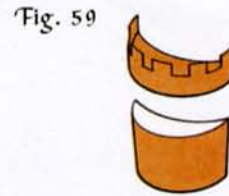

FIG. 59. Fold and glue part 119 (parapet), and cut out the white rectangles. Glue the parapet to the assembled parts 115-118, so that the floor is level with the bottom edge of the printed area inside the parapet, then glue the two sections of the turret together as shown.



FIGS 60, 60A, 61. Turret support 6. Glue parts 120-122 together as shown.

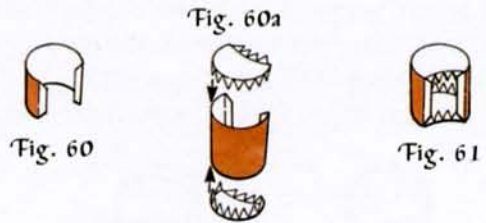

FIG. 62. Turret 6. Assemble part 124 by gluing tab a to the inside of the opposite end panel, to form an octagonal tube, then glue to part 123.

FIG. 63. Glue both ends of part 126 to part 125, to form a circular wall.

FIG. 64. Apply a little glue to the inside top edge of the wall, set it top down on a flat surface and push in the support from the base until part 123 is level with the top edge.

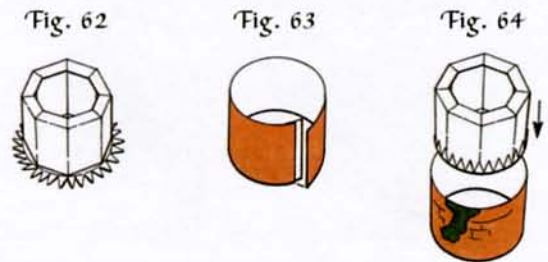

FIG. 65. Glue on part 127 (base), making sure all tabs are inside the wall.

FIGS 66, 66A. Assemble and glue parts 128-130, to form the circular floor.



FIG. 67. Fold and glue part 132 (parapet) and glue on part 131 as illustrated.

FIG. 68. Cut out the white rectangles.

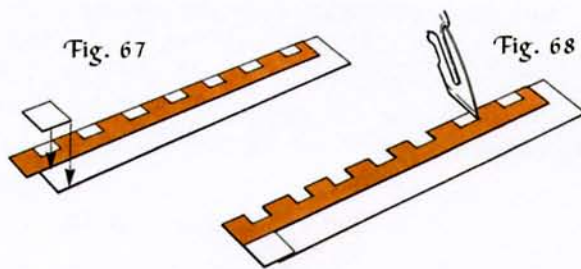
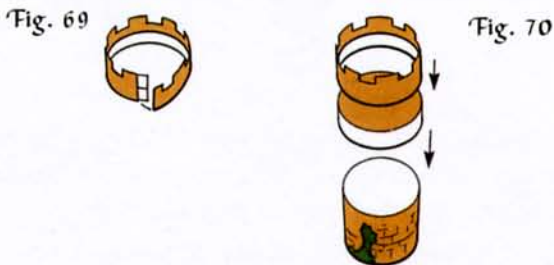

FIG. 69. Glue the ends of parts 132 and 131 together, to form a circular wall.

FIG. 70. Apply a small amount of glue to the inside of the parapet wall below the printed area and insert the circular floor until it is level with the lower edge of the printed area and flush with the bottom edge of the wall. Glue the assembled top to the main turret wall. Assemble Turret 7 (parts 133–142) and Turret 8 (parts 143–152) by the same method.



FIGS 71, 71A. Turret supports 7 and 8. Glue the tabs on part 153 to the inside top edge of part 154 as shown, making sure that the edge of part 154 is level with the flat top all the way round. Glue parts 155 and 156 together in the same way.

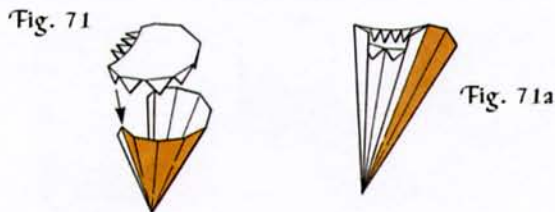

FIG. 72. Bridges. Glue the tabs on part 161 to the inside of the arches of part 160.

FIGS 73, 73a. Fold and glue parts 162 and 163 (parapets), and cut out the white rectangles.

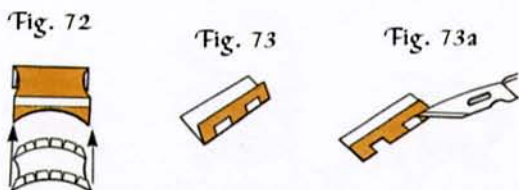

FIG. 74. Glue the parapets to the bridge. Assemble the second bridge (parts 164–167) by the same method.

FIG. 75. Fold and glue parts 157–159 (parapets)

and cut out the white rectangles. Write the number of the part on the unprinted area of each parapet, to guide you at the final assembly stage. You may have to trim these to fit; there are some spares on page 165.



FIG. 76. On the top floor of the tower and around its top edge you will find location areas marked for turrets and parapets. In the areas for turrets 2, 6, 7, and 8 on the tower floor there is a circle with the letter 'S' and a line pointing to the edge of the tower. When gluing these turrets into position make sure that the seams on their walls line up with the points on the edge indicated by these © symbols. The final assembly should be done in the following order:

Support for Turret 1.

Turret 2 and support.

Turrets 3 and 4.

Turret 5 and support.

Turret 6 and support.

Parapet (part 157).

Turret 7 and support.

The large bridge (between turrets 6 and 7).

Parapet (part 158).

Turret 8 and smaller bridge (between turrets 7 and 8).

Support for Turret 8.

Parapet (part 159).

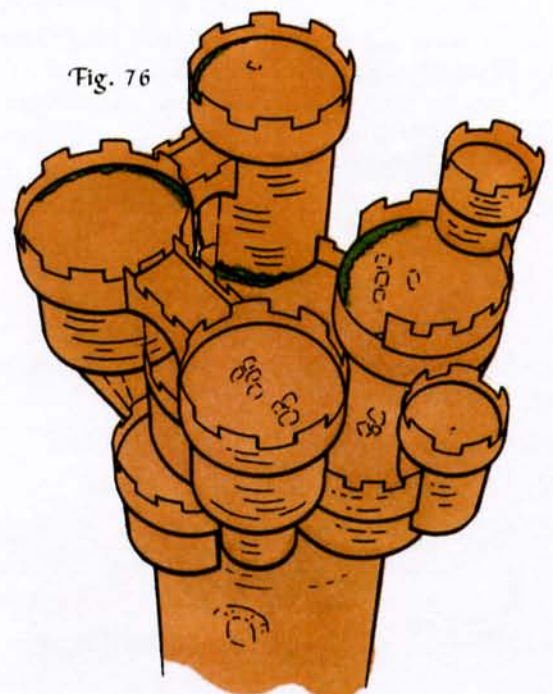

THE GREAT HALL PART I

FIG. 1. Assemble **part 1** (stairs), first folding the treads. Glue tabs *b* to the inside of the printed side panel, and base tab *c* to the bottom of the back panel. Then glue the top to tab *a* and the blank side panel to tabs *d* on the back and the base.

FIG. 1A. Glue the tread sections of the steps to tabs *e*.

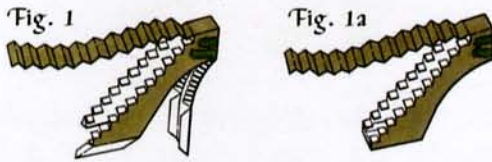

FIG. 2. Assemble **part 2** (recessed door) by gluing tabs *a* to the top of the unprinted side of the side walls.

FIG. 2A. Assemble **part 3** (step) by gluing side panels *3b* and *3c* to tabs *a*.

FIG. 2B. Glue **part 3** to **part 2**.

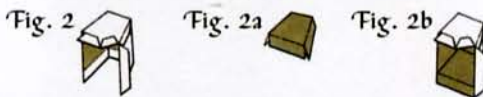

FIG. 3. Assemble **part 4** by gluing the top to tabs *a* and the base to tabs *b*.

FIGS 4, 4A. Glue tabs *c* and *b* of **part 2** to **part 4** as shown. Make sure the folded edge of the side tab is flush with the edge of the opening.

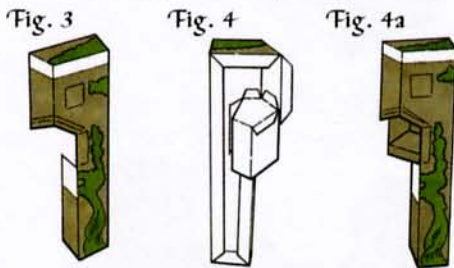

FIG. 5. Draw three lines on the reverse of **part 5** (where the tabs have a square end) as illustrated. Cut and fold back the tabs *5b* and *5i*.

FIG. 6. The assembled door and turret (**parts 2–4**) are now to be attached to **part 5**. Dry fit first and only glue once you are confident of how they go together. Tabs *4c*, *4d* and *4e* should match up with their location points on **part 5**, and the recessed door passes through the wall of **part 5** where you have cut tabs *5b* and *5i*. These tabs are to be glued to the side panels of **part 2**. Once **parts 2–4** are fixed, glue **part 1** (stairs) into position as shown.

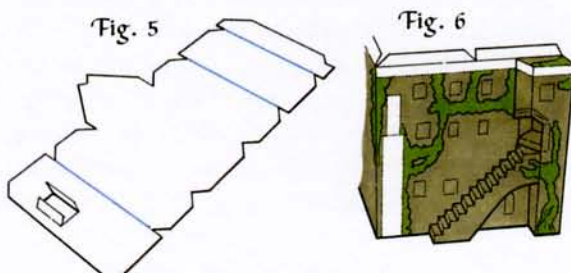

FIG. 7. Glue **parts 1–5** to the floor plan, using the tab locations for positioning.

FIG. 8. Glue **parts 6 and 7** in place using the lines you drew earlier and the tab locations on the floor plan as guides.

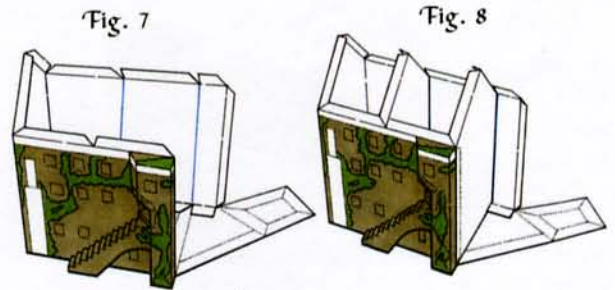

FIG. 9. Draw a line on the reverse of **part 8** as illustrated.

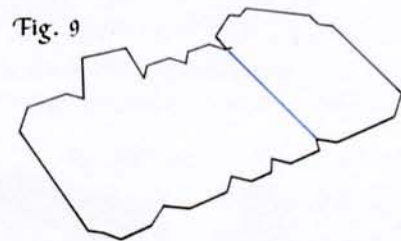

FIG. 10. Glue tab *8g* to the reverse so that the folded edge of the tab is level with the line you have just drawn.

FIG. 10A. Glue **part 8** to the floor plan and to tab *5a*, and glue tab *8a* to **part 7**. Then glue the flat top to tabs *8b*.

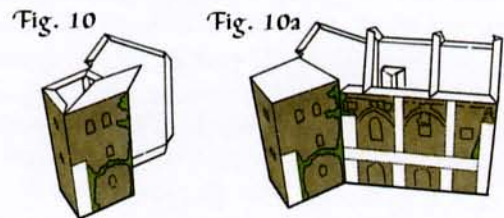

FIG. 11. Assemble the hipped roof (**part 9**), by gluing base tabs *a* and tabs *b* to the underside of the roof edges as shown.

FIG. 12. Glue **part 9** into position as illustrated.

FIG. 13. Glue **part 10** (main roof) into position. Dry fit first. Make sure tabs *10a* and *10b* match up with their location marks.

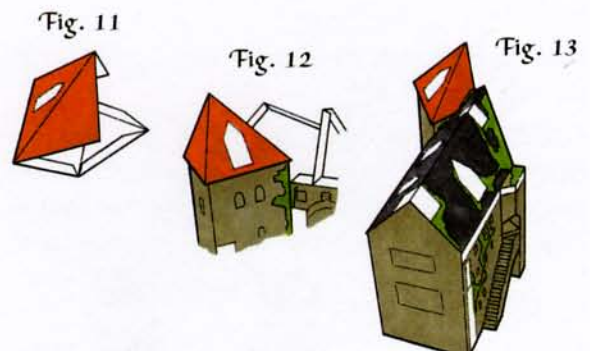

FIG. 14. Assemble the parapet (part 11). Cut the three lines indicated from the score line to the edge, then fold over and glue. Cut out the 'v' shaped areas.

FIG. 14A. Glue the parapet to the top of the wall as illustrated.



FIG. 15. Assemble part 12 by gluing tab *a* to the opposite side panel then the base to tabs *b* and the top to tabs *c*.

FIG. 16. Assemble parts 13, 14 and 15 by gluing tab *a* to the opposite side panel then the base to tabs *b*. Don't glue tabs *c* until you come to fix the buttresses to the main building (see FIG. 19).

FIG. 17. Assemble part 16 by gluing tab *a* to the opposite panel then the side panels to tabs *b*.

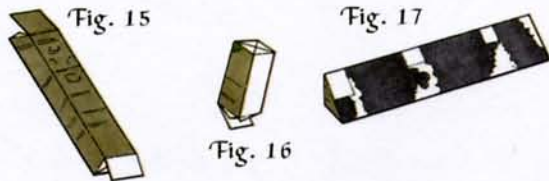

FIG. 18. Assemble parts 17, 18 and 19 by gluing tab *a* to the opposite side panel then the top to tabs *b*. Don't glue tabs *c* until you're ready to fix the buttresses to the main building.

FIG. 19. Assemble parts 20 and 21 by gluing tab *a* to the opposite panel, then the base to tabs *b* and the top to tabs *c*. Assemble part 22 by gluing tab *a* to the opposite panel and the top to tabs *c*. You can now glue parts 12–22 (buttresses and low side roof) to the main building. Add each part in numerical order (this is vital with parts 13–19).



FIG. 20. Assemble the dormer windows (parts 23, 25, 27 and 29). Glue the side panels to tabs *a* then fix each window to its respective location on the roofs.

FIG. 21. Fold part 24 (dormer roof) and glue it to the tabs on part 23.

FIG. 21A. Fold parts 26, 28 and 30, and glue to the tabs on their respective windows. Fold down the barge-board sections on the front edge as shown.



FIG. 22. Chimneys. Assemble parts 31 and 33 by gluing tab *a* to the opposite side panel to form the stack. Assemble parts 32 and 34 by gluing tab *a* to the opposite end panel, then the base to tabs *b* and the tops to tabs *c*. Glue part 32 to part 31 and part 34 to part 33.

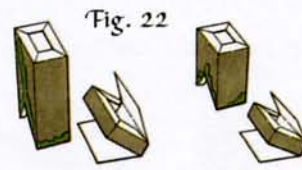

FIG. 23. Glue the chimneys in their respective positions on the main building, which is now complete.

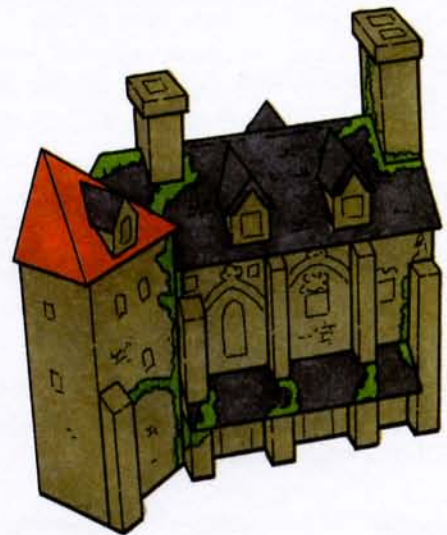

Fig. 23



THE GREAT HALL PART II

FIG. 1. Make sure you have drawn the necessary guidelines on the reverse of parts 1, 15, 18, 20, 23, 32 and 37.

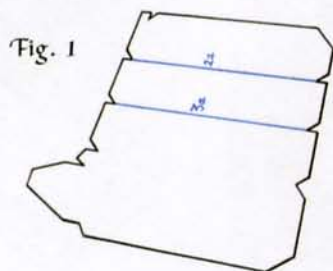

FIG. 2. Glue part 1 to the floor plan, then glue parts 2 and 3 in position, ensuring that the side tabs 2a and 3a are glued to the corresponding lines that you've drawn on the reverse of part 1. Glue parts 4 and 5 into position.

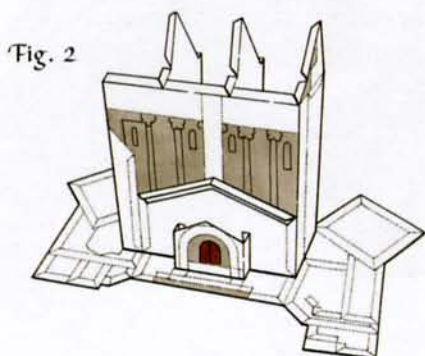

FIG. 3. Glue part 6 to the reverse of part 7 so that it is flush with the internal edge of the arch as illustrated.

FIG. 3A. Glue parts 6 and 7 to part 5 and the floor plan.

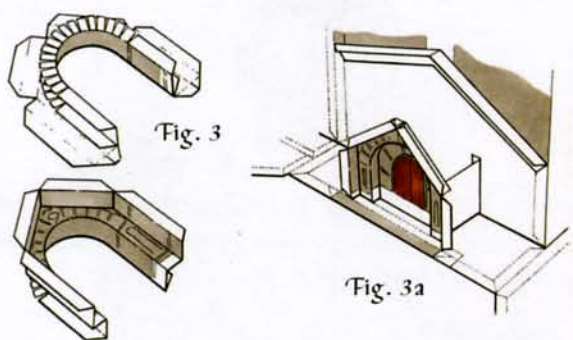

FIG. 4. Glue part 8 to the floor plan and to tabs c of part 7 so that the 'reveals' of part 7 are flush with the edge of the internal uprights on part 8. The two upper reveals above the arch should, when folded, meet in the centre and, at either end, with the vertical reveals. (See FIGS 5A and 5B which show the complete assembly, including part 9, from the reverse and the base.)

Fig. 4

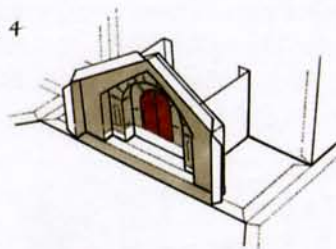

FIG. 5. Assemble the steps (parts 10 and 11). Glue tab a to the opposite panel and tuck and glue the side panel tabs b to the back panel on part 10 and base panel on part 11. Glue both parts into position.

Fig. 5



FIG. 5C. Glue part 9 to the floor plan, to part 1 and to tabs c of part 8, again ensuring that the internal edge is level with the reveals of part 8. Then glue on part 12 (roof) as shown.

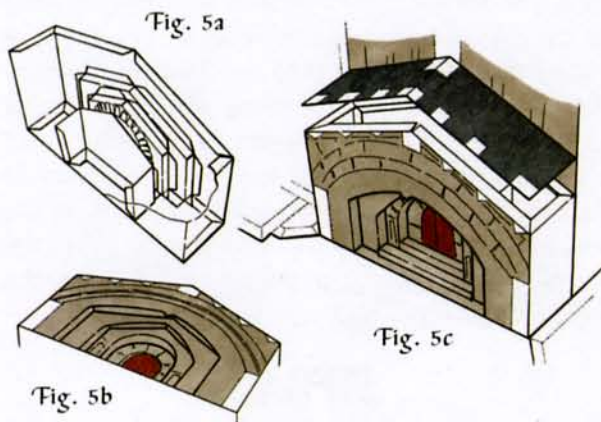
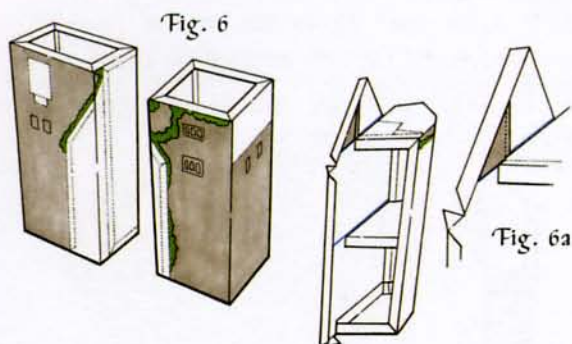

FIG. 6. Assemble parts 13 and 14 (towers), by gluing tab a to the opposite panel. Fold the wall panels round and glue the top and bottom edges to tabs a-e on the base and top. The folded edge of the top tab e should then align with the guideline 15e you have drawn on the reverse. Apply a small amount of glue to tabs a-f on part 16 and slide it into the back of the assembly, level with the central line, to create a support. Make sure it is pushed all the way in. Glue part 17 into position as illustrated (see FIG. 6A).



FIGS 7, 7A. Glue **part 15** into position on the floor plan, then **parts 13** and **14**. Make sure that tab *1f* is glued to **part 13** and that **part 14** is firmly fixed to **part 15** using tab *15b* and tabs *g* on **parts 15** and **16**.

Fig. 7

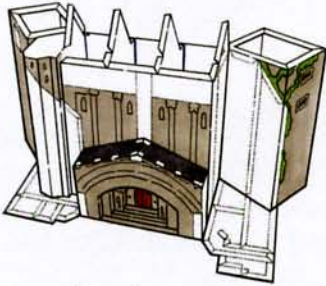
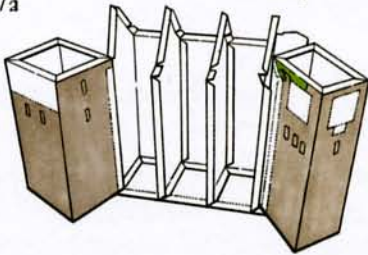

Fig. 7a



FIGS 8, 8A. Dry fit **part 18** in position; if it is too tight a fit rescore at both ends on the illustrated side of the dashed lines and dry fit again. When you're happy with the fit glue it to the floor plan, to tabs *3c*, *2c* and *15i* (aligning them with your drawn guidelines), and to both towers. Glue on the main roof (**part 19**); again you are recommended to dry fit first. As well as gluing the roof to the tabs on the four ridge supports, make sure to glue tab *19a* to the tower and to fold and glue the parapet section to the top of the wall (**part 18**).

Fig. 8

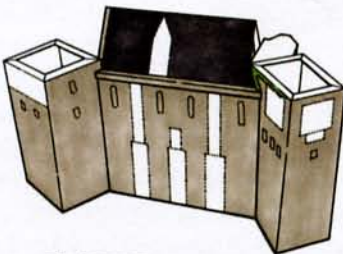

Fig. 8a

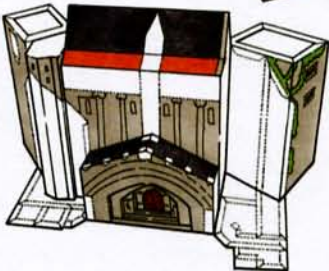

FIG. 9. Glue **part 21** to the top of **part 20** as illustrated, using the tabs marked **20** in red.

FIG. 10. Glue **parts 20** and **21** into position as shown.

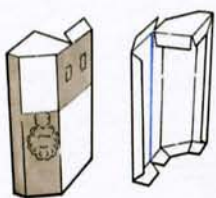

Fig. 9

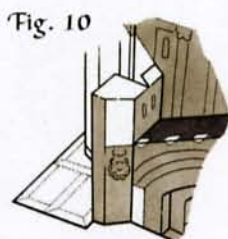

Fig. 10

FIGS 11, 11A. Glue **part 22** (gable wall) in position, ensuring that tab *22c* is aligned with the line drawn on the reverse of **part 20**, and tab *21a* is fixed to the location indicated on **part 22**.

Fig. 11

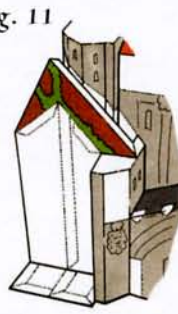
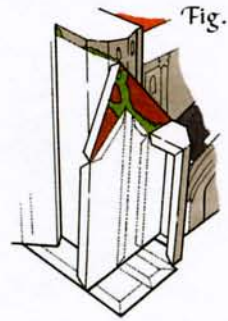

Fig. 11a



FIGS 12, 12A. First dry fit, then glue **part 23** to the floor plan, to the tower, and to tabs *22a*, *20a* and *21b*; and tab *23g* to its location area on **part 22**. Then glue **part 24** (wall support) into position using the line drawn on the reverse of **part 23** as a guide.

Fig. 12



Fig. 12a



FIG. 13. Glue **part 25** (roof) in position on **part 22**, fixing tabs *25a-e* to their locations on the walls behind; then glue on **part 26** (lower roof) as illustrated.

Fig. 13



FIG. 14. Fix on **part 27** by gluing tabs *27a* and *27b* to the location points on the tower and turret, and the folded ridge section to **part 25** (roof).

Fig. 14



FIG. 15. Glue part 28 in position as illustrated.

FIG. 16. Glue part 29 into position as shown.

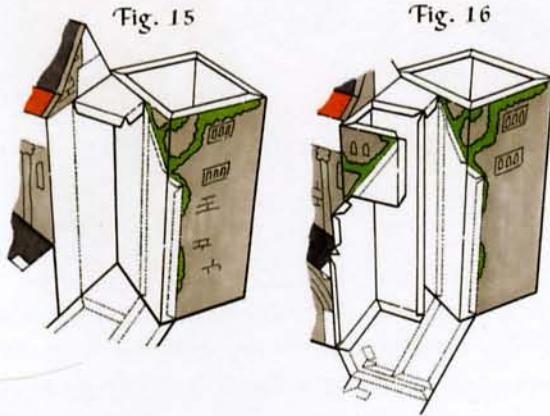

FIG. 17. Fix part 30 into position, ensuring that it is correctly glued to tabs 28a, 29a and 29b.

FIG. 18. Glue part 31 (roof support tab) to part 29 as illustrated.

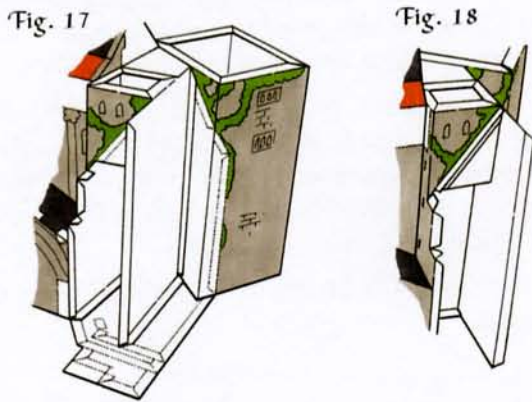
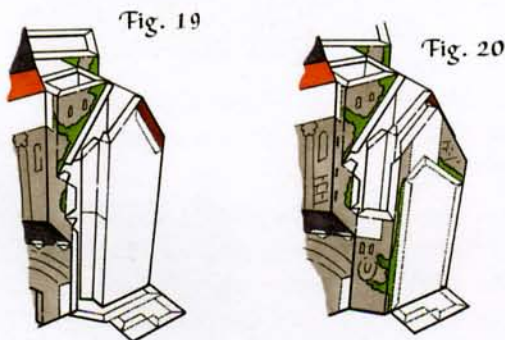

FIG. 19. Glue part 32 to the floor plan and to end tab 30c, level with the line drawn on the reverse.

FIG. 20. Glue part 33 to the floor plan, then glue the left end tab to tab 29d and tab 33d to its location area on part 32.



FIGS 21, 21A. Assemble part 34 by gluing tab a to the reverse of the door panel.



FIGS 22, 22A. Glue part 34 to the reverse of part 35 so that tabs b, c, d and e are flush with the corresponding edges of part 35, as illustrated.

FIG. 22B. Assemble the stairs, part 36, by gluing the sides to tabs a, then base tab b to the back panel and side tab b to the base, and finally the steps to tabs c.

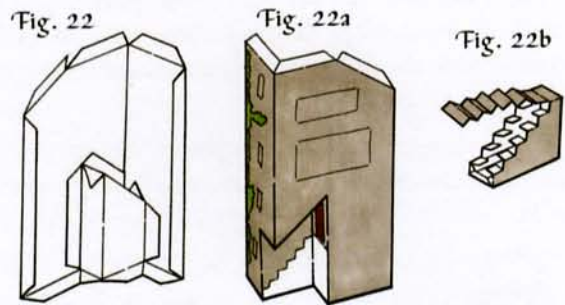
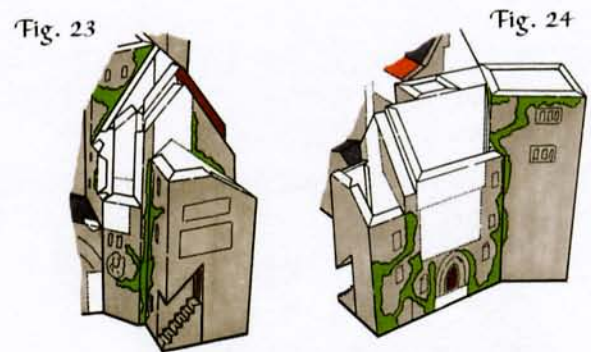

FIG. 23. Glue parts 34 and 35 to the floor plan and end tab 35a to its relevant area on part 33. Glue the stairs (part 36) into place.

FIG. 24. Glue part 37 (wall) to the floor plan and to tabs 35d, 33c and 32e, and end tab 37d to the tower.



FIGS 25, 25A. Assemble part 38 by gluing the sides to tabs a and b.

FIG. 26. Assemble parts 39 and 40 by gluing the bottom panel to tabs a then the top panel to tabs b and the back to tabs c.

FIG. 26A. Assemble part 41 by gluing tab a to the opposite panel then the top to tabs b.

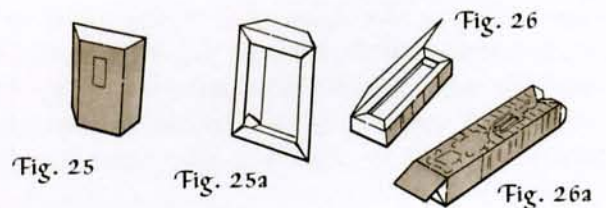

FIG. 27. Glue parts 38-41 in place as illustrated.

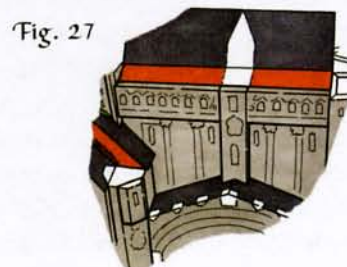

FIG. 28. Assemble **part 42** (octagonal turret) by gluing two panels to tabs *a* at the top and the base, then the remaining panels to tabs *b* and finally end tab *c*.

FIG. 28A. Glue tab *a* on **part 43** to the opposite end roof panel. Apply a little glue to tabs *a* on **part 44** and fix to the inside of the turret roof (**part 43**). Try to make it level when it sits inside the roof (the dotted line on the diagram indicates roughly how it should look when fixed).

FIG. 28B. Assemble **part 45** (turret support) by gluing the sides to top tabs *a* then the front panel to tabs *b*.

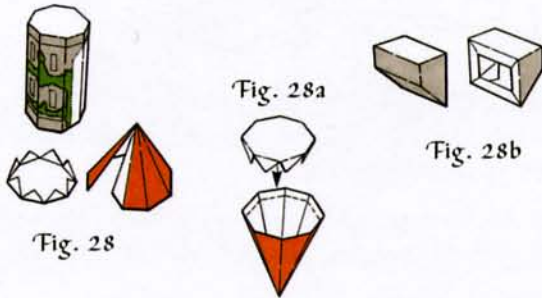

FIG. 29. Glue the turret (**part 42**) in place. Dry fit first, ensuring that it lines up with all relevant tabs. Glue support (**part 45**) in place.

FIG. 30. Glue **part 46** (small roof section) in place as shown.

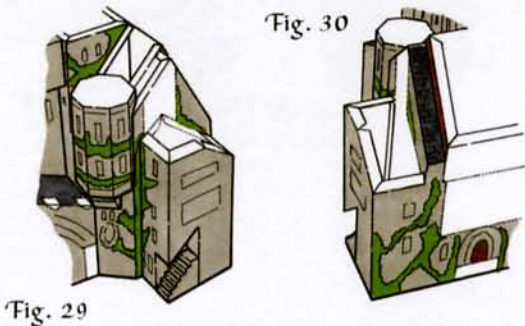
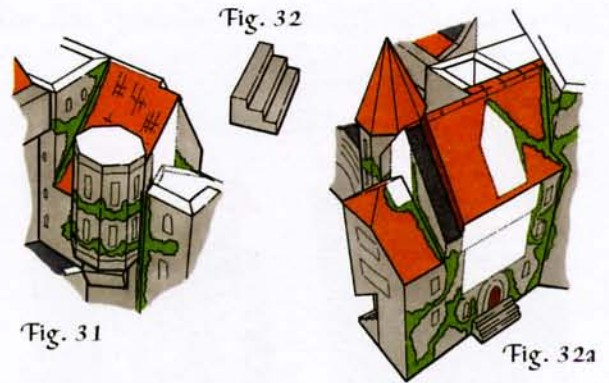

FIG. 31. Glue **part 47** (roof) in position. Dry fit first: slide the roof down until it butts up to the octagonal turret walls, ensuring that it sits on all the available top tabs of the relevant walls and the support tab (**part 31**). Tab *47a* should hang over the top of **part 30** to provide a glue point for the opposite roof section.

FIG. 32. Assemble **part 50** (steps) by gluing the sides to base tabs *a* and the steps to tabs *b*.

FIG. 32A. Glue **part 50** into position. Glue the octagonal turret roof (**parts 43–44**) in place. Assemble the hipped roof (**part 48**) by gluing the ridge together using tab *c*, then glue into position. Glue **part 49** (roof) in position. Fold the small ridge tiles so that they hook over onto the opposite roof section (**part 47**). Glue the large ridge tiles to **parts 28** and **29**, and glue tabs *49a* and *49b* to the tower.



FIGS 33, 33A, 33B. Assemble **part 51** by gluing tab *a* to the adjacent roof panel, then the remaining panels to tabs *b*, *c*, *d*, *e*, and finally to tabs *f* and *g*.



FIGS 34, 34A. Assemble **parts 52** and **53** (buttresses) by gluing one side panel to base tabs *a*, then the other side to tabs *b*, and finally the top to tabs *c*.

FIG. 35. Assemble **parts 54–60** (gargoyles) by gluing the triangular side panels to tabs *a*. Fold down the triangular front sections. On **part 57** tuck in and glue the small tabs *c* to the back of the square front section.

FIG. 36. Glue **parts 51–60** to the main building as illustrated.

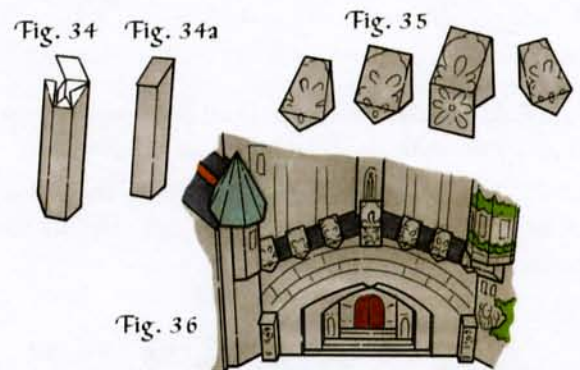

FIG. 37. Glue **parts 62** and **63** to **part 61**, making sure that **62** and **63** are also glued together at the folds.

FIGS 37A, 37B. Apply glue to the edges of **part 63** and fix on **part 64**, wrapping the tabs over the edge. Glue the bottom section to the underside of **part 61** as shown in FIG. 37B. Glue **part 65** to **part 62** in the same way, folding and gluing the bottom section as before.

FIG. 37C. Glue **parts 66** and **67** to the tabs of **parts 64** and **65**, gluing the bottom sections to the underside of **part 61** as before.

FIG. 37D. Glue on the ridge tiles and capping stone (**parts 68–72**), as illustrated. (Assemble **part 72** by gluing tab *a* to the opposite end panel, before fixing it to the roof.)

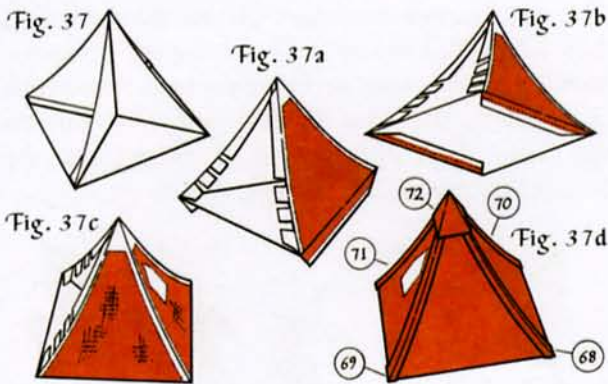

FIG. 38. Glue parts 74 and 75 to part 73 as shown.

FIG. 38A. Glue on parts 76 and 77 as you did part 64, folding and gluing the bottom sections to the underside of part 73.

FIG. 38B. Glue parts 78 and 79 in place as before, also gluing tab *a* on part 79 to the reverse of part 78. Glue on the ridge tiles and capping stone (parts 81–84) as illustrated.

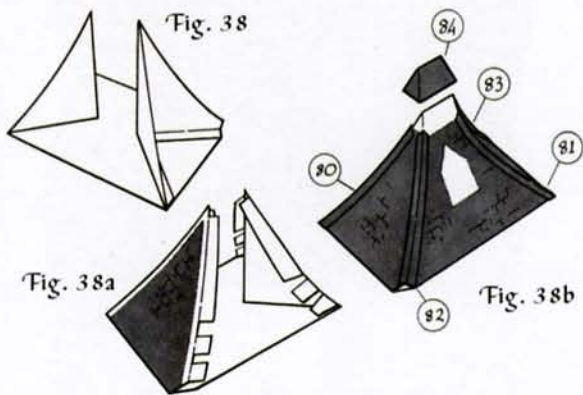

FIG. 39. Place the roofs on their respective towers using the dotted lines on parts 15 and 28 as a guide for positioning. Don't glue them yet.

FIG. 40. Assemble part 86 (roof) by gluing tab *a* to the opposite roof panel, then glue to part 85 as shown, so that the bottom edge of the roof is flush with the base (part 85). Make sure that the roof panel with the staggered edge is glued to the side of part 85 with the raised tab.

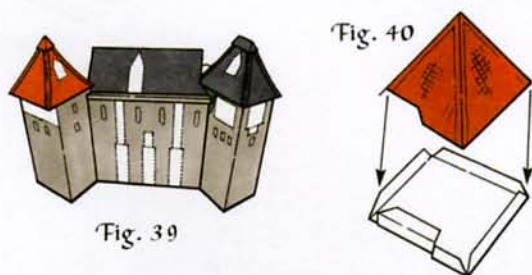

FIG. 41. Glue part 88 to the reverse side of part 87. Make sure the two bevelled corners are adjacent.

FIG. 41A. Assemble part 89 by gluing tab *a* to the underside of the long ridge section, then glue part 89 to parts 87 and 88.

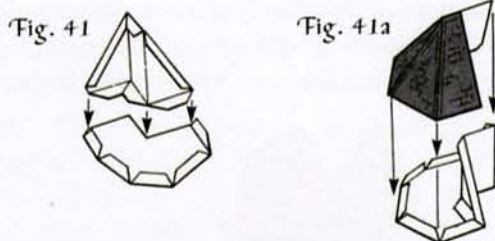

FIG. 42. Assemble part 90 by gluing tab *a* to the opposite side panel, then the base to tabs *b* and the top to tabs *c*.

FIG. 42A. Assemble part 91 by gluing three sides to tabs *a* on the base and top, then the remaining sides to tabs *b* and finally tab *c*.

FIG. 42B. Assemble part 92 by gluing tab *a* to the opposite panel, then the base to tabs *b* and the top to tabs *c*.

FIGS 42C, 42D. Assemble parts 93 and 94 by gluing tab *a* to the opposite panel and the top to tabs *b*.

FIG. 43. Glue parts 90–93 (chimneys) in position, then the small roof (parts 85–88), then the large roof (parts 61–72) and finally part 94 (chimney). There are no markings on either large roof for the chimneys parts 94 and 96; follow the location guides on the adjacent chimney sections, then glue the tabs to the roofs where they fall.

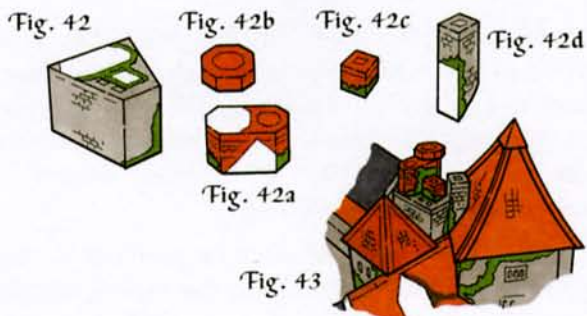

FIG. 44. Assemble part 95 by gluing tab *a* to the opposite panel, the base to tabs *b*, and the top to tabs *c*.

FIG. 44A. Assemble part 96 by gluing tab *a* to the opposite panel and the top to tabs *b*.

FIG. 44B. Assemble part 97 by gluing three sides to tabs *a* on the base and top, then the remaining sides to tabs *b* and lastly tab *c*.

FIG. 44C. Assemble part 98 by gluing tab *a* to the opposite panel, the base to tabs *b* and the top to tabs *c*.

FIG. 44D. Assemble part 99 by gluing tab *a* to the opposite panel then the top to tabs *b*.

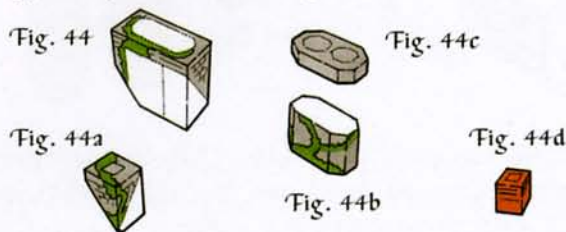

FIG. 45. Glue part 95 (chimney) in position, then the small roof (parts 87–89), then the large roof (parts 73–84) and finally parts 96–99 (chimneys).



FIG. 46. Assemble part 100 by gluing the side and back to tabs *a*, then the other side panel to tabs *b* and the roof to tabs *c*. Then assemble part 101 by gluing the side and back to tabs *a* and the other side to tabs *b*.

FIG. 47. Assemble parts 102 and 103 by the same method.

FIG. 48. Assemble part 104 as you did part 100.

FIG. 49. Assemble part 105 by gluing the angled lower front panel to tabs *a* then the top to tabs *b*.

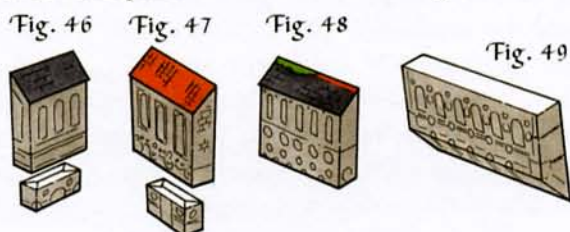

FIG. 50. Assemble part 106 by gluing the side panels to top tabs *a* then the angled lower front panel to tabs *b*. Assemble part 107 by gluing the triangular side panels to base tabs *a* then the roof to tabs *b*. Glue parts 100–107 to their respective locations on the main building.

FIG. 51. Chimneys. Glue tab *a* on part 108 to the opposite side panel, then glue the top to tabs *b*. Glue tab *a* of part 109 to the opposite side panel, then the base to tabs *b* and the top to tabs *c*. Glue part 109 to part 108.

FIG. 52. Assemble parts 110 and 111 by the same method. Glue both chimneys to their respective locations on the main building.

FIG. 53. Buttresses. Assemble parts 112–115 by gluing one side to base and back tabs *a* then the other side to tabs *b* and the top to tabs *c*.

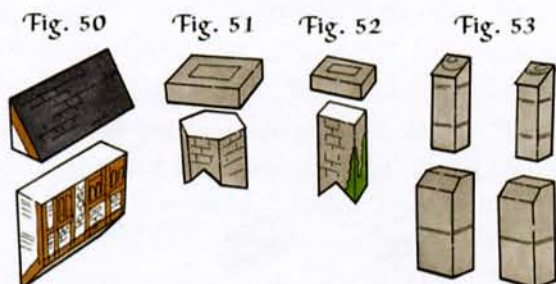
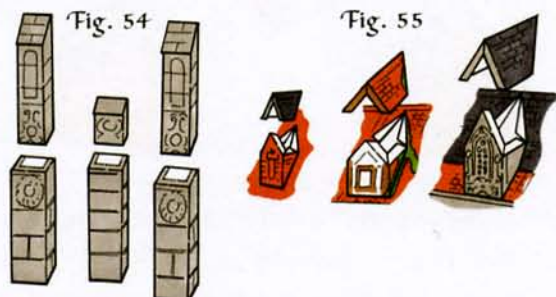
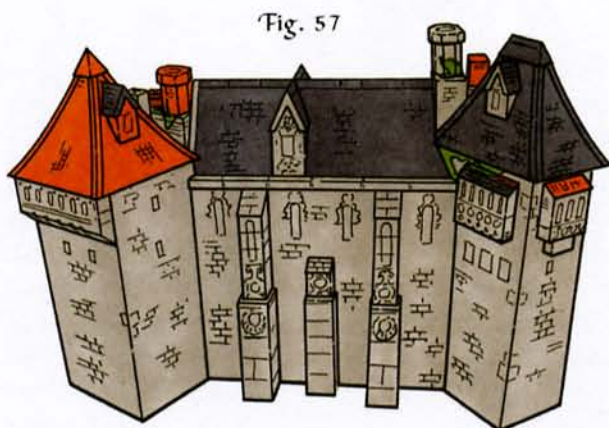

FIG. 54. Assemble parts 116 – 121 by the same method. Glue all buttresses (parts 112–121) to their positions on the main building.

FIG. 55. Dormer windows. Assemble parts 122, 124, 126, 128, 130 and 132 by gluing the triangular side panels to tabs *a*. Glue dormers into their positions on the main building first, then glue on the roofs. Remember to fold down and glue the bargeboard sections on the gable ends.



FIGS 56, 57. The completed building.



THE CLOCKTOWER

Make sure you have drawn in all the guidelines required (indicated by blue circles).

FIG. 1. Draw a line 80mm from the base on the reverse side of **part 1** across the whole width.

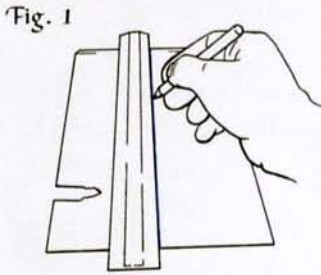

FIG. 2. Fold **part 1** as illustrated.



FIGS 3, 3A. Assemble **part 2** by gluing tabs *a* to the reverse of the top panel to form a porch way, then glue the bottom edge of the porch way to tabs *a*, *b* and *c* on **part 3** (tower base).

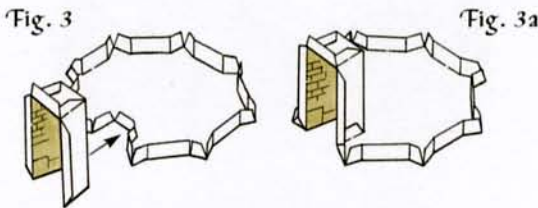
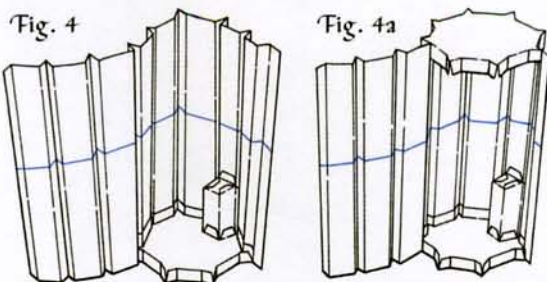

FIG. 4. This stage could be a bit tricky. Dry fit first by wrapping **part 1** around **parts 2** and **3**, making sure all the folds are correct; this will help you get an idea of the task ahead. Glue tabs *b* on the porch way and tabs *d* and *h* on the base and fix to the bottom of the tower wall (**part 1**), so that the porch walls are flush with the vertical edges of the archway on the tower. Then glue tabs *e*, *f* and *g* on the base and fix the bottom of the appropriate tower panels to them. Don't glue tab *z* or the end panel on the tower. Next, glue tabs *i* - *n* and fix the bottom edge of the tower to them.



FIGS 4A, 4B. Fix **part 4** to the top of the tower so that it is flush with the top edge; then fix **part 5** to

the middle, level with the drawn line. These two parts should be glued only to those wall panels already glued to the base and porch way.

FIG. 4C. Now carry on gluing the tower wall panels to **parts 3, 4** and **5** (starting where you left off) up to and including tab *1a* on the tower which attaches to tab *z* on the base. Finally glue the remaining panel on the tower (the one you left unglued in FIG. 4) to tab *1a*.

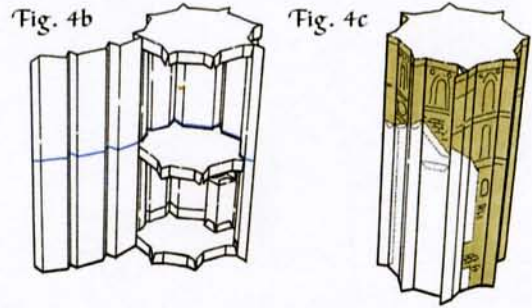

FIG. 5. Place the two floor plans so that the dotted line for the tower and the cut edges line up, and glue the tower to them.

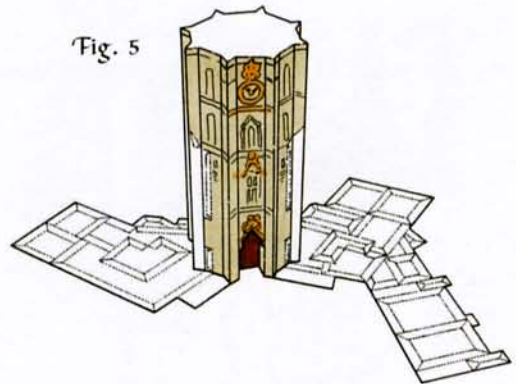

FIG. 6. Fold **part 6** as illustrated.

FIG. 6A. Glue **part 6** to the reverse of **part 7** (base). Start at the end with tab *a* and work round, accurately fixing tabs *b* so that each panel is flush with the edge of the base, finishing by gluing the last panel to tab *a*.

FIG. 6B. Glue the reverse side of **part 8** to tabs *c* of **part 6**, again making sure that the sides are flush with the edge of **part 8**.

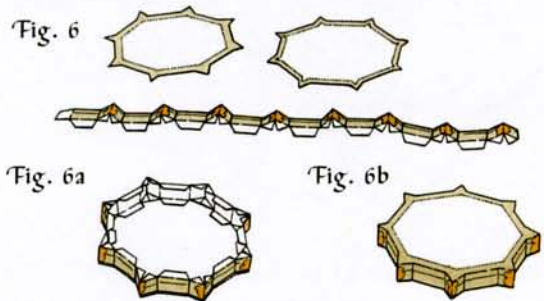

FIG. 7. Glue the assembled **parts 6, 7** and **8** to the top of the tower. Assemble **part 9** by gluing tab *9a* to the opposite side panel. Glue **part 9** to the floor

plan and glue the corner edge between *9d* and *9e* to the tower using the dotted line on the tower wall as a guide. Use a pen or something similar if you need to manoeuvre the side panels of **part 9** from the inside so that they sit correctly on the plan. Once you're satisfied that the part is positioned correctly, glue the top to tabs *9b*.

FIG. 8. Glue **part 10** (support wall) into position. Ensure that tab *10a* is glued to **part 9** as well as gluing tabs *10b* and *10c* to the floor plan.

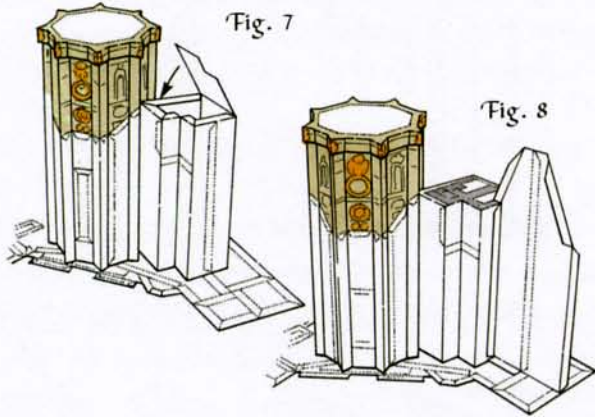
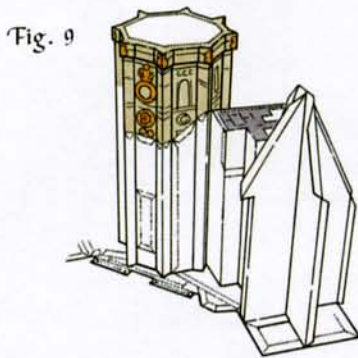

FIG. 9. Glue **parts 11** and **12** in position as shown.



FIGS 10, 10A. Assemble **part 13** (wall): on the central panel at the top, fold and glue panels *A* and *C* to tabs *A* and *C*, then panel *B* to tab *B*, and finally panel *D* to the location marked, forming a long box section open at one end.

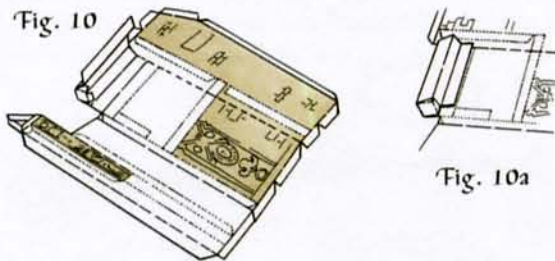

FIG. 10B. Glue **part 13** to the tower using tab *13a*; glue tabs *13b-f* to the floor plan; and glue tabs *11a* and *10a* to the reverse, level with the drawn guidelines. Make sure to tuck the box section under the overhang of **part 11**. Glue tab *13b* to its location on **part 9**.

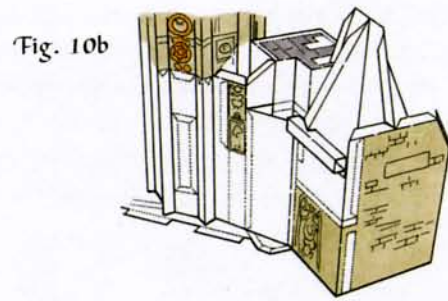
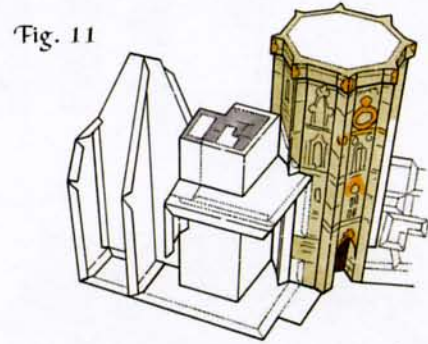

FIG. 11. Glue **part 14** to **part 9** and the tower using tabs *14a-e* and the locations marked.



FIGS 12, 12A. Fold back the porch section of **part 16** and fix **part 15** to the wall panels by gluing tab *15a* to the reverse of the bottom edge of the opening and tabs *b-e* to the three wall panels.

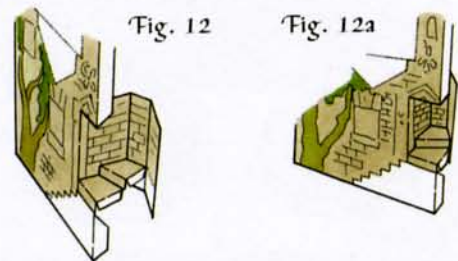

FIG. 13. Fix **part 16** into position in stages. Start at the tower end: glue the tab marked *14* in red to the underside of **part 14**, and tabs *16d* and *16e*, the end porch wall panel, and tabs *f* and *g* on the steps to the tower (specific location guides are not given for the porch wall and steps), and tab *16c* to the floor plan. Next glue tabs *16b* and *16a* to the floor plan, and the reverse of the wall to tabs marked *16* in red on **part 14**, to end tab *12c* and finally to tab *13g*.



FIG. 14. Assemble **part 17** by gluing the lower angled panel to tab *a* then the smaller lower panel to tab *b*.

FIG. 14A. Assemble part 18 by gluing the top to tabs 18f and 18g.

FIG. 14B. Assemble part 19 by gluing small tab *a* to the back of the lower front panel and base tab *a* to that side panel. Repeat for tabs *b*, then glue the back to tabs *c*.

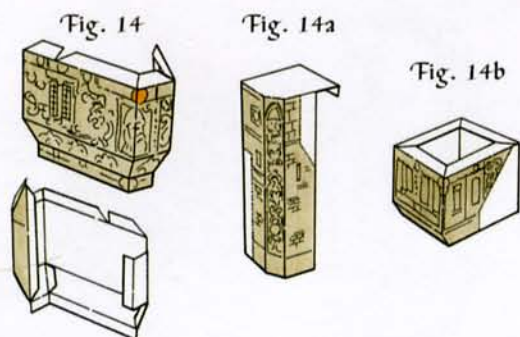

FIG. 15. Fix part 18 into position by attaching tabs 18b and 18i to their locations on part 9 (in this instance you are recommended to apply glue to the location areas rather than to the tabs), and gluing tabs 18b, 18c, 18d to the floor plan and tabs 18a and 18e to part 13 (wall). Fix part 17 in place, by gluing tabs 17c-f, and the bottom panels on the side and front, to their location areas on parts 13 and 18. Glue part 19 to the top of part 18 as illustrated.

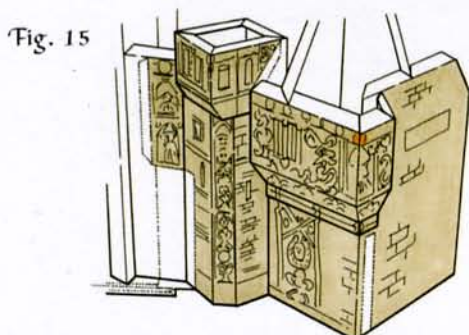

FIG. 16. Fix part 20 (parapet) in place, by gluing it to all tabs marked 20 in red, and tab 20a to part 14. Fold all the remaining tabs to form a support for the top panel (to be fixed later).

FIG. 17. Assemble part 21 by gluing tab 21a to the opposite side panel, then glue into position on the floor plan. This is a similar assembly to part 9: once again use a pen or something like it to manoeuvre the base tabs from the inside if necessary. Once it is in position, glue the top to tabs *b*.

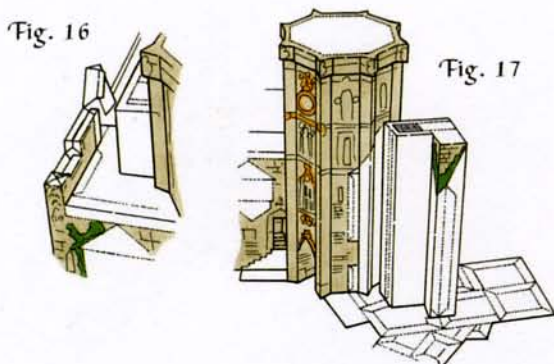

FIG. 18. Glue part 22 to the floor plan and to part 21.

FIG. 19. Glue parts 23 and 24 to part 22 and the floor plan.

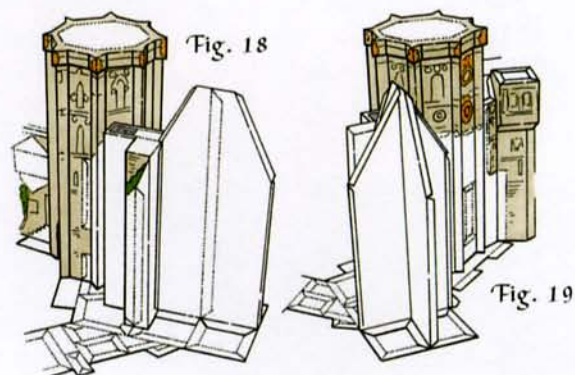

FIG. 20. Glue part 25 to part 21 and the floor plan.

FIG. 21. Glue tab 27a on part 27 (steps) to the reverse of the bottom edge of the opening for the porch on part 26. Then glue tabs *b-e* to the three small wall panels.

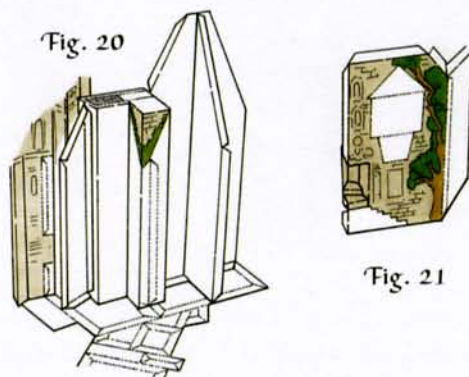

FIG. 22. Fix parts 26 and 27 into position. Start by gluing tabs 26a, the back of the last wall panel of the porch, and tab *f* on the steps to the tower, then tabs 26b and 26c to the floor plan, and the reverse to tab 25a. Glue tabs 26d and 26e to the floor plan and 26f to part 21. Glue part 28 to the corner.

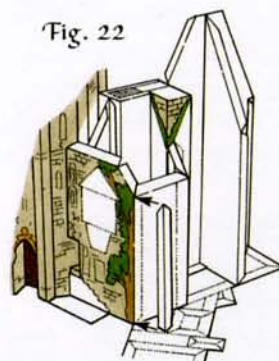

FIG. 23. Start fixing part 29 in position by gluing tab 29a to part 21, tab 29b to the floor plan, and panel 29b to the end panel of part 28. Glue base tabs 29c and 29d to the floor plan and the reverse of this section to tab 24a.

FIG. 23A. Glue the remaining base tabs to the floor plan and the reverse side to tabs 22*d* and 23*c*.

Fig. 23

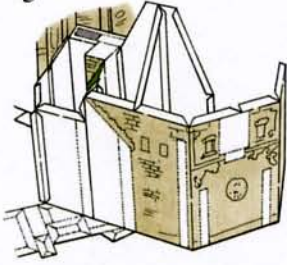
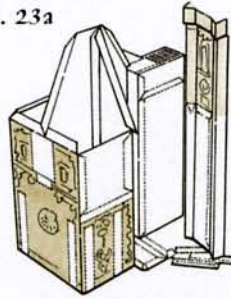

Fig. 23a



FIGS 24, 24A. Assemble part 30 by gluing the triangular tab *A* to the reverse of the small square panel above and to the left of the tab. Then glue tab *B* to the reverse of the left side panel, level with your drawn line *B*.

FIG. 25. Glue part 30 to the floor plan, to part 21, and to the tower as shown.

Fig. 24

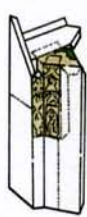

Fig. 24a

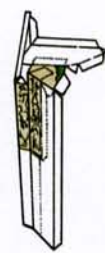

Fig. 25

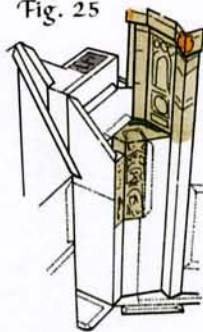

FIG. 26. Assemble part 31 by gluing tab 31*e* to the opposite side panel and the top to tabs *f*.

FIG. 26A. Assemble part 32 by gluing tab *a* to the opposite side panel and the base to tabs *b*.

FIG. 26B. Assemble part 33 by gluing the angled lower front panel to tabs *a* and folding the side and back tabs at 90 degrees to each other.

FIG. 27. Glue part 31 in position, then part 32, ensuring the back and sides are level with the corresponding dotted lines (part 32 should overhang at the front by about 3–4mm). Fix on part 33 by gluing tabs 33*b–d* and the reverse of the bottom front panel to their respective marked areas.

Fig. 26

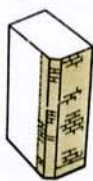

Fig. 26a



Fig. 26b



Fig. 27

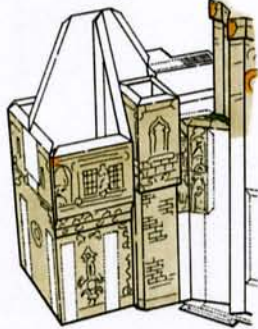

FIG. 28. Glue part 34 to the floor plan, and the folded corner to part 26, using the dotted line as a guide.

FIG. 29. Glue part 35 to the floor plan, to the wall (part 29), and to tabs 34*a* and 34*d*.

Fig. 28

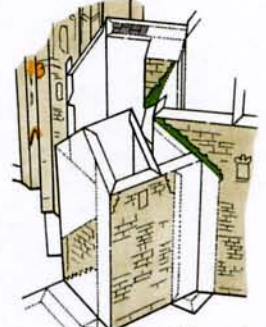
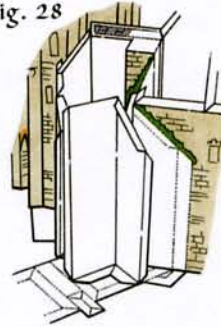

Fig. 29

FIG. 30. Assemble part 36 (stairs), by gluing the back to tabs *a* and *b*, then the tread sections to tabs *c*. Assemble part 37 by gluing tab *a* to the opposite side panel and the top to tabs *b*.

FIG. 31. Glue parts 36 and 37 into position as illustrated.



Fig. 30

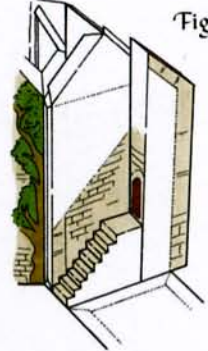

Fig. 31

FIG. 32. Assemble part 38 by gluing end tab 38*a* to the reverse, lining it up with the drawn line 38*a* and the vertical edge of the archway. Fix part 39 to the inside middle section, gluing tabs 39*a* and 39*b* level with the drawn lines as illustrated. (Make sure the bottom edges are level.)

FIG. 33. Dry fit the assembled parts 38 and 39 to the main building, then glue into position as illustrated: apply glue to the side of the stairs (part 36), the area on part 37 marked 38 in red, to tabs 28*b* and 35*a*, and to the base tabs on parts 38 and 39.

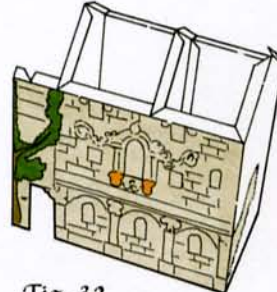

Fig. 32

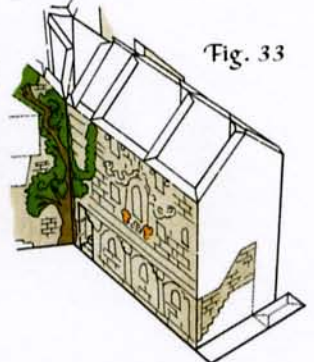

Fig. 33

FIG. 34. Glue **part 40** into position as illustrated.

FIGS 35, 35A. Assemble **part 41** as illustrated: glue both tabs marked *a* to the corresponding edge on the opposite main panel, then glue the shorter end panel to tab *b*. Glue the small overhanging ceiling panel to tabs *c*, then the roof panel with the end tab to tabs *d*, and finally the remaining roof panel to tabs *e*.

FIG. 35B. Assemble **part 42** (steps) by gluing the back to tabs *a* and *b*, then the treads to tabs *c*.

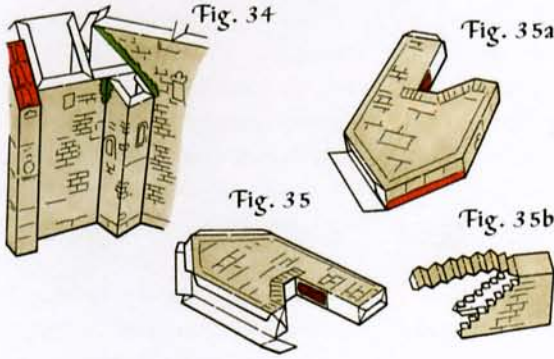

FIG. 36. Fix **parts 41** and **42** in position, using the lines on **part 41** as a guide when gluing to **part 38**.

FIG. 37. Assemble **part 43** by gluing the small panels with tabs *c* and *d* to tabs *a*.

FIG. 37A. Glue the small base panels to tabs *b*.

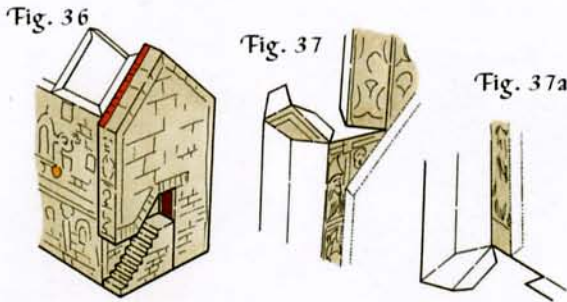

FIG. 38. Fold back both lower side panels and glue tabs *c* to the reverse side so that the top tab *c* is level with the top of that panel and the base tab *c* is level with the bottom edge.

FIG. 38A. Fold back the upper side panels and glue the bottom edges to tabs *d*, then glue the top panel to tabs *e*.

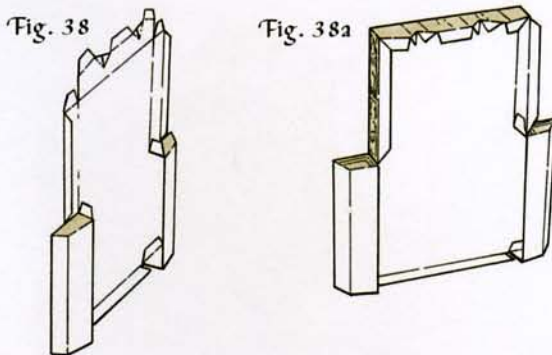

FIG. 39. Assemble **part 44** by gluing tab *a* to the opposite end, and glue it in position on the tower as shown.

FIG. 40. Dry fit **part 43** in position, before gluing it. Fix tabs *43f-s* and the bases of the two bottom side panels to their corresponding location areas; remember to apply some glue to **part 44** too. Glue **part 45** in position as illustrated.



FIG. 41. Glue **part 46** (reveal) to the reverse of **part 47** so that the sides of the opening are flush with the edge of the internal arch.

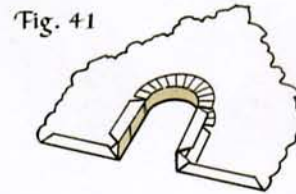

FIG. 42. Fix **parts 46** and **47** into position so that the arch reveal lines up with the door on **part 43**, the base tabs are glued to the floor plan and the reverse is glued to the tabs on **part 45**.

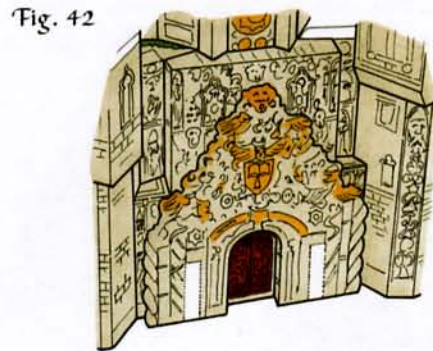
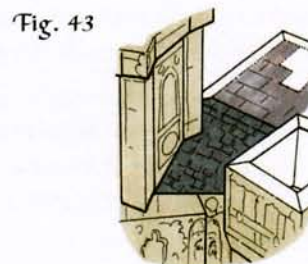
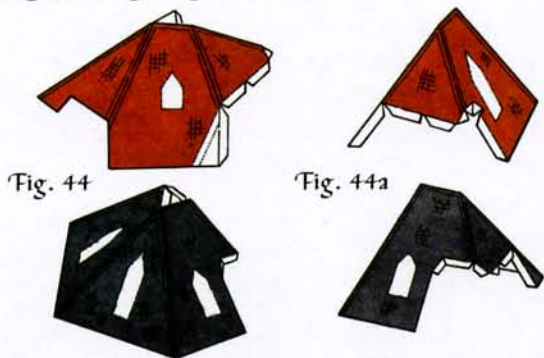

FIG. 43. Fix **part 48** (roof) in position, by gluing tabs *a*, *b* and *c* to the tower and the other three edges to tabs or areas marked **48** in red.



FIGS 44, 44A. Assemble parts 49 and 54 (roofs) by gluing tab *a* to the opposite roof panel to form a ridge, then gluing tab *b*.



FIGS 45, 45A. Dry fit both roofs first; if you have any difficulty lining up the bottom edges with the top of the walls cut a little off the top of part 10 or part 22 respectively. Fix the assembled part 49 to all tabs numbered 49 in red and glue tabs 49a, 49e and 49f to their corresponding locations. Glue the hip and ridge tiles, parts 50–53a, in position as illustrated.

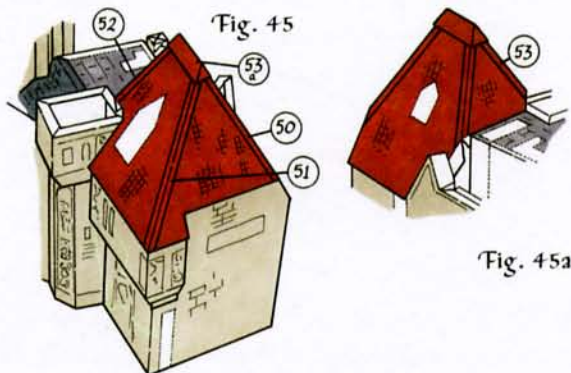

FIGS 46, 46A. Fix on the other assembled roof, part 54, by gluing to all tabs numbered 54 in red and gluing tabs 54a–54c to their location areas. Glue the hip and ridge tiles, parts 55–59, in position as illustrated.

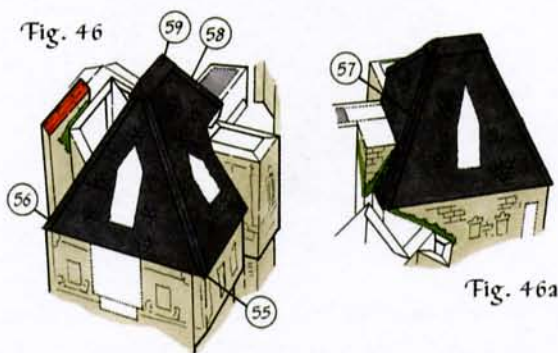

FIG. 47. Fix on part 60 (small roof section) by gluing to areas marked 60 in red, and gluing tabs 60a–60c to their locations on part 30 and the tower.

FIG. 48. Fix on part 61 by gluing to areas marked 61 in red, gluing the small tab *a* to the tower and tab 61b to its location on part 21. Glue part 62 (tab) to its location on part 61.

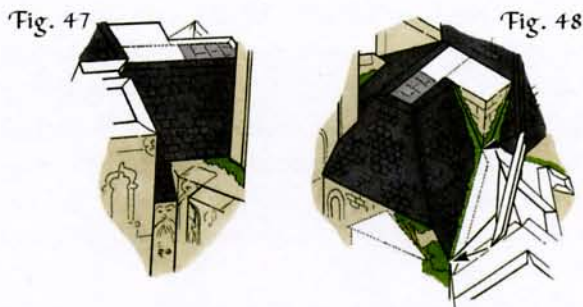

FIG. 49. Assemble part 66 (chimney) by gluing tab *a* to the opposite side panel, then the base to tabs *b*. On part 67 glue tab *a* to the opposite side panel then the base to tabs *b* and the top to tabs *c*. Glue to the top of part 66. Assemble part 68 by gluing the base to tab *a* then the triangular side marked 35 in red to tabs *b* and the small front panel to tabs *c*.

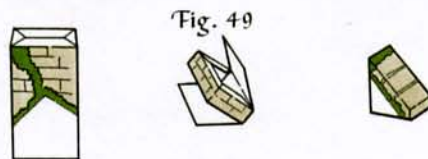

FIG. 49A. Fix on part 63 (roof) by gluing it to tabs marked 63 in red and the top of part 34, and gluing tabs 63a and 63b to their locations on the roof and wall (parts 49 and 29). Glue part 64 (the ridge tiles) to the roof (optional). Glue parts 66–68 in position using the dotted lines as a positional guide.

FIG. 49B. Glue part 65 (small roof) to the tabs marked 65 in red.

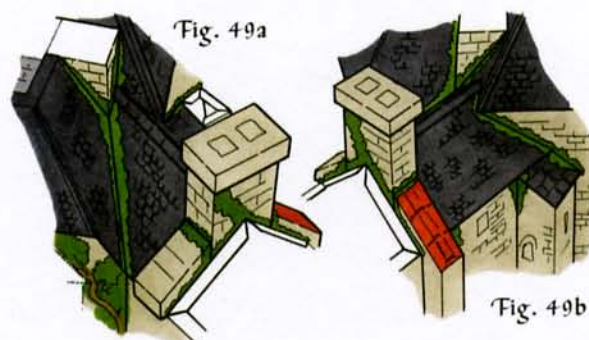
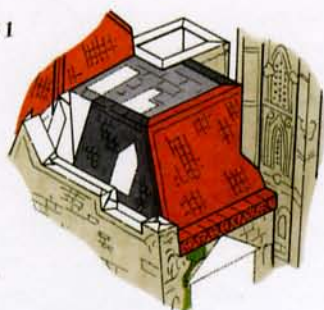

FIG. 50. Fix on part 69 (roof) by gluing it to all tabs marked 69 in red. Fold down the lower panel on the section with the single dormer marked 132, and glue to the top of the wall. Glue part 70 (ridge tiles) to the roof (optional).



FIG. 51. Fix the roof **part 71** in place. Glue to all areas marked **71** in red and glue tabs **71b–e** to their respective locations. Glue the two lower panels to the edge of **part 14** and the top of the wall **part 16**.

Fig. 51



FIGS 52, 52A. Assemble **part 72** (chimney stack). Glue tab **a** to the reverse side so that it is level with the left hand edge of the archway and glue tabs **b** and **c** to the location points. Fold the remaining side panels to form an 'L' shape, and glue tab **d** to the other side of the arch and tabs **e** and **f** to their locations. Assemble **parts 73** and **74** by gluing tab **a** to the opposite side panel, the base to tabs **b** and top to tabs **c**.

FIG. 53. Assemble **part 75** (chimney), by gluing tab **a** to the opposite side panel. Assemble **part 76** by gluing tab **a** to the opposite side panel, the base to tabs **b** and top to tabs **c**.

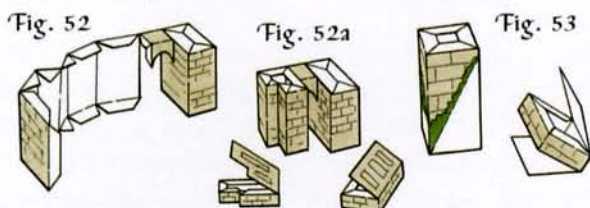

FIG. 54. Fix **part 75** into position, gluing it to **part 9**, and to tabs **71a**, **49g**, **16f**; then glue **part 76** to **part 75**. Glue **part 72** to its location on **part 9**, then glue **parts 73** and **74** to **72**. Glue **part 81** (parapet top) to all tabs marked **81** in red and tabs **81a** and **81b** to their locations on the chimney and roof.

FIG. 55. Assemble **parts 77** and **79** by gluing tab **a** to the opposite side panel. Then assemble **parts 78** and **80** by gluing tab **a** to the opposite side panel, the base to tabs **b** and the top to tabs **c**. Glue first **part 77**, then **part 79** to their locations on **part 21**. Glue **part 78** to **part 77** and **part 80** to **part 79**.

Fig. 54

Fig. 55

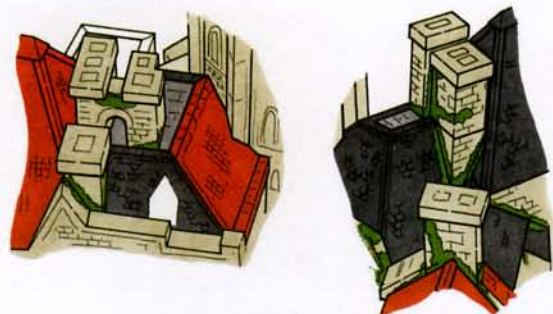

FIG. 56. Glue **part 83** to the reverse side of **part 82**, then fold the tabs on **part 82** up so that the red numbers are visible.

FIG. 56A. Glue **parts 84** and **85** to **part 83**, gluing **84** and **85** together where they meet in the centre.

FIG. 56B. Glue **parts 86** and **87** to their respective tabs and the edges of **parts 84** and **85**, folding the tabs over to provide gluing points for **parts 88** and **89**.

FIG. 56C. Glue **parts 88** and **89** to their corresponding base tabs and the tabs on the adjacent roof panels. Glue on the hip tiles and cap (**parts 90–94**). On the base (**part 82**) you will see some numbers indicating which tile to fix to each corner and which section of the roof is the front.

Fig. 56

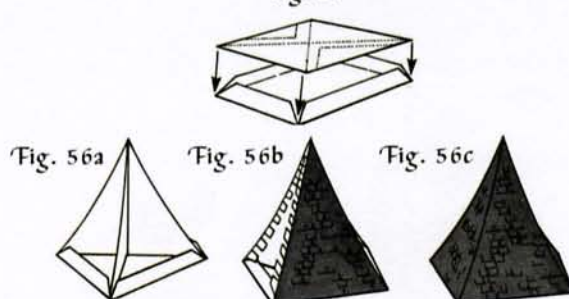
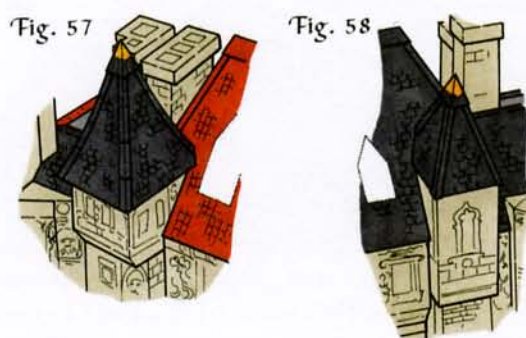

FIG. 57. Glue the assembled roof to **part 19** (tabs numbered **82** in red), and to tabs **49b** and **49c** on the large roof section.

FIG. 58. Assemble **part 95** by gluing tab **a** to the opposite roof panel. Fix in position by gluing to tabs marked **95** in red and to tabs **54e** and **54f** on the main roof section. Glue on hip tiles and cap (**parts 96–100**), **96** and **97** going to the back corners next to the main roof.



Buttress assembly

FIG. 59. **Parts 101 – 104** and **110**: glue tab **a** to the opposite side panel, then the base to tabs **b**, the sloping front panel to tabs **c**, the vertical front panel to tabs **d** and the top to tabs **e**.

FIG. 60. **Parts 105** and **106**: fold both sides so that they are at 90 degrees to the back panel and glue the small front panels to tabs **a–f**. (It's a good idea to pre-fold and dry fit first.)

FIG. 61. **Parts 107 – 109**, **111** and **112**: glue tab **a** to

the opposite side panel, then the base to tabs *b* and the top to tabs *c*.

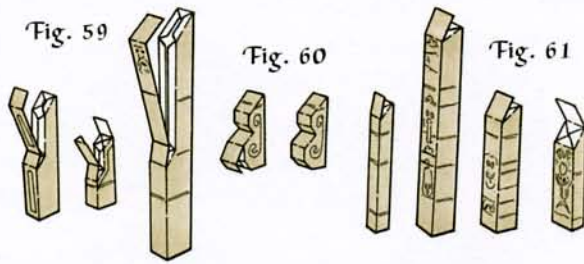

Once assembled glue the buttresses to their locations on the main building.

FIG. 62. Assemble the bay window, parts 113 and 114: glue tab *a* on part 113 to the opposite side panel, the base to tabs *b* and the roof to tabs *c*. On part 114 glue the side panels to tabs *a*. Glue part 113 to its location on the main building, then attach part 114 by gluing tabs *b* to the building and tabs *c* to the base of part 113.

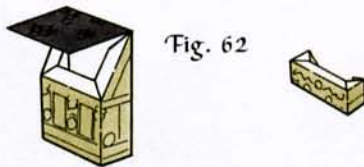

Dormer windows

FIGS 63, 63A, 63B. It is best to assemble the 'window' parts first and fix them to the building, then fix on the roof sections. On parts 115, 118, 121, 123, 126 and 129 glue the triangular sides to tabs *a*. Glue each part to its location point on the building.



FIGS 64, 64A, 64B. Assemble the dormer roofs, parts 116, 119, 124, 127 and 130 by gluing tab *a* to the bottom edge of the adjacent roof panel, then tabs *b* and *c*. Glue the roofs to their respective 'windows' and main roofs. Part 122 should be glued directly to the tabs on part 121 marked 122 in red; then fold down and glue the bargeboard panels. The ridge tiles, parts 117, 120, 125, 127 and 131, can now be glued to their respective dormer roofs.

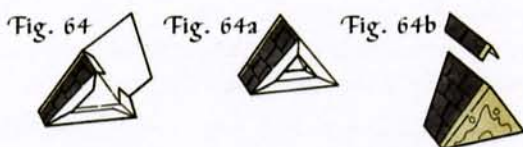

FIG. 65. Assemble part 132 by gluing tab *a* to the bottom edge of the opposite, triangular side panel. Glue to its location on the main roof part 69, and the lower part of the front gable panel to the wall

part 38. Glue the dormer roof, part 133, to tabs marked 133 in red; fold down the bargeboard panels and glue to the top of the gable.

FIGS 66, 66A. Assemble parts 134 and 135 by gluing the roof panel adjoining the base panel to tab *a* so that the folded edge of tab *a* is level with the score line of the bargeboard section, which can then be folded and glued to the gable front panel. Now glue the other roof panel to tabs *b* and *c* and fold and glue the remaining bargeboard section. Glue each part to the location point marked in red on roof part 69.

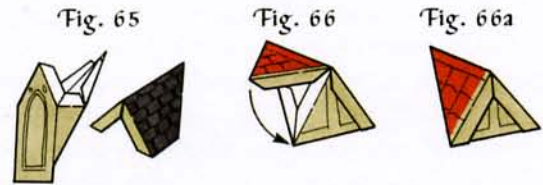

FIG. 67. Assemble parts 136 and 137 (steps) by gluing the tread sections to tabs *a*. Fix to the location areas on the main building, gluing the blank sides and tabs *c* to the wall and tower and tabs *b* to the floor plan.

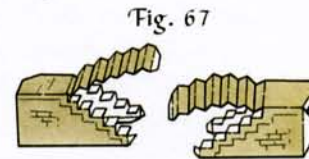

FIG. 68. Assemble parts 138–140. On part 138 glue tab *a* to the reverse of the triangular panel marked with *a* in red, then glue the six small panels to tabs *b–g* and end tab *h*, so that the folded edges of the tabs are level with the bottom edge of the panels. On part 139 glue the bottom edge of the six main panels to tabs *a–f* and to end tab *g*. On part 140 glue the end roof panel to tab *a*, then glue tabs *b* to the lower edge of the roof panels.

FIG. 69. Assemble parts 141–143. On part 141 glue the side panels to tabs *a* and *b*. On part 142 glue the lower edges of the four main panels to tabs *a–d* and to end tab *e*. On part 143 glue the end roof panel to tab *a*, then the lower edges of the roof panels to tabs *b*.

FIG. 70. Glue parts 138–143 to their respective locations on the main building.



The dome

FIG. 71. Roll each triangular panel on **part 144** so that it acquires a natural curve. Glue the end of panel *b* to its location marked on the hexagonal tab on panel *a*.

FIG. 72. Glue panels *c* and *d* to their respective segments on the hexagonal tab.

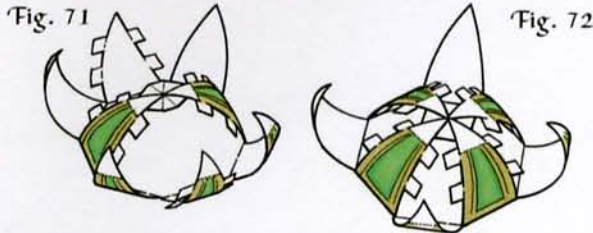

FIG. 73. Glue panels *e* and *f*, then panels *g* and *h* to their respective segments on the hexagonal tab and to tabs on the adjacent panels.

FIG. 74. Roll **parts 145–152**, then fold down the central score line. Glue each part to the dome to cover the joins between the panels, making sure that they are level at the base.

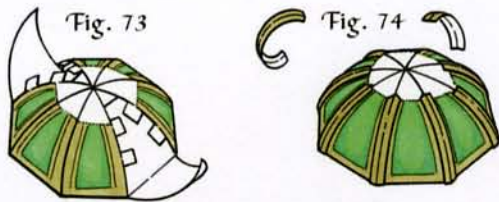

FIG. 75. Assemble **part 153** by gluing the panels with tabs *a* to the top panel, ensuring that the side panels are flush with the edge of the top. Then glue the panels with tabs *b* to the top and to end tab *c*.

FIG. 76. Assemble **part 154** by gluing tab *a* to the opposite side panel. Push in tabs *b*.

FIG. 77. Assemble **part 155** by gluing tab *a* to the opposite triangular panel, then the top to tabs *b*.



FIG. 78. Assemble **part 156** by gluing tab *a* to the opposite panel to form an octagonal cone.

FIGS 79, 79A. Cut a slot in **part 157** as illustrated, then glue tab *a* to the opposite triangular side panel.



FIGS 80, 80A. Fold **part 158** in half and glue. Glue the reverse side of **part 159** to the white area on **part 158**, then fold and glue the other half of 159 so that it wraps around 158, making the weather vane.

FIG. 81. Gently push the weather vane into the slot in **part 157**; if it doesn't fit at first, make the slot bigger. Apply glue round the slot from the inside, to fix the parts together.

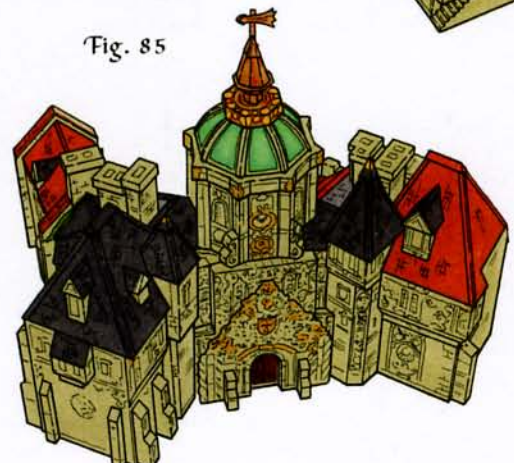
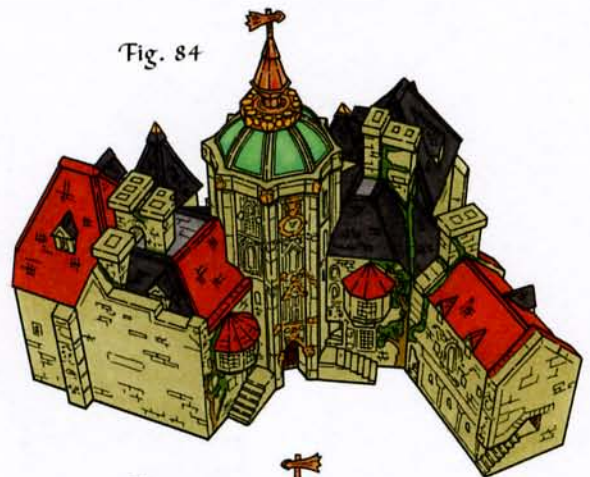

FIG. 82. Glue **part 153** to the main dome, then glue on **part 154**. Glue **part 155** to the pushed-in tabs on **part 154** so that the pointed end sits inside; try to get this join as level as you can.

FIG. 83. Glue **part 156** to **part 155**. Fix the assembled weather vane so that the top of **part 156** is glued to the inside of **part 157**. Glue the assembled dome to the top of the tower, aligning the ribs of the dome with the projections on the tower.



FIGS 84, 85. The completed building.



PLAN OF THE UNIVERSITY

Use this plan as a guide to fit the buildings together.

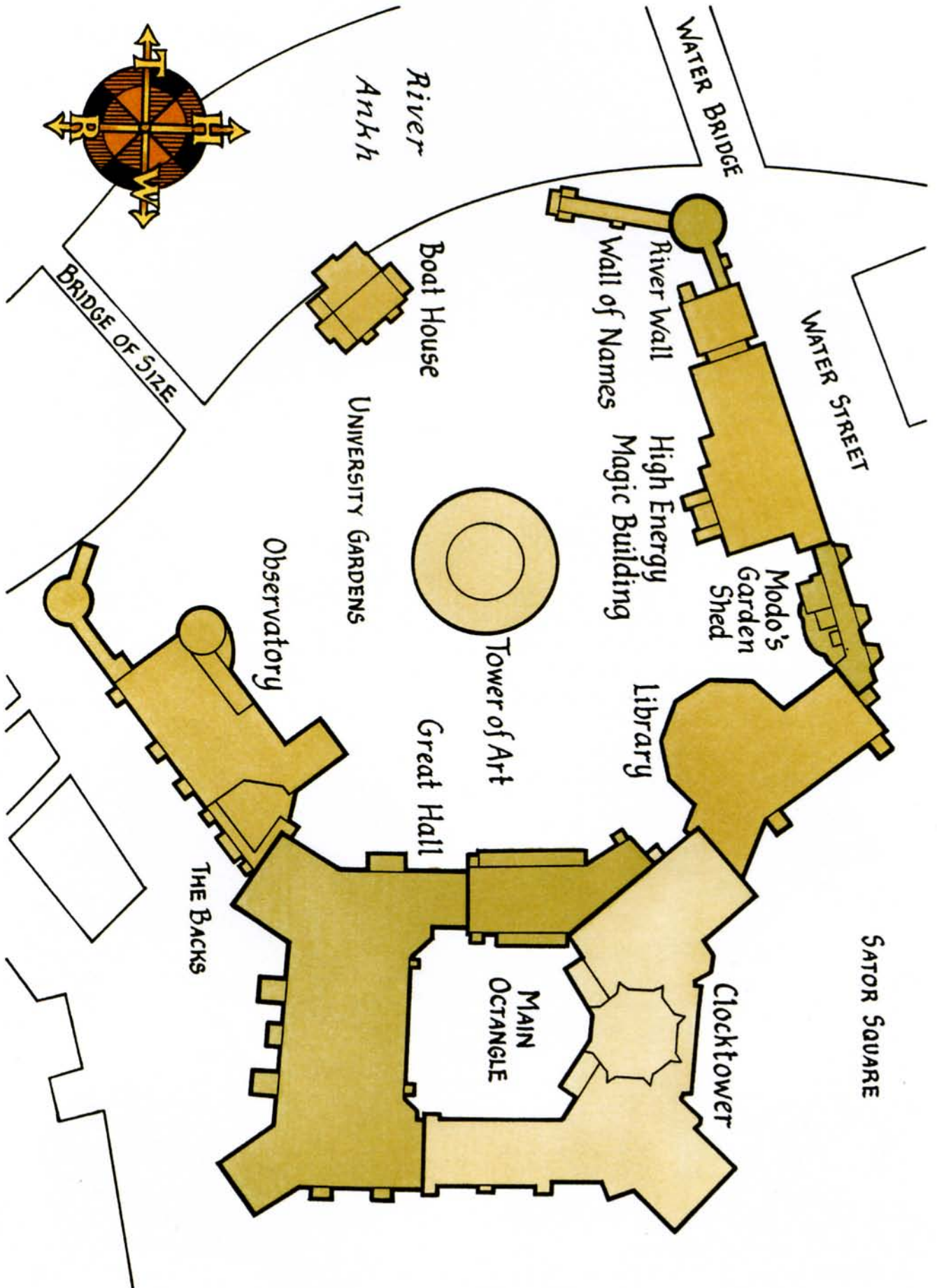

Beyond thys page
lies the great
Unseen University.
Let blade be sharpe*
and straightedge
un-notched lest the
Dungeon Dimentions
break through.

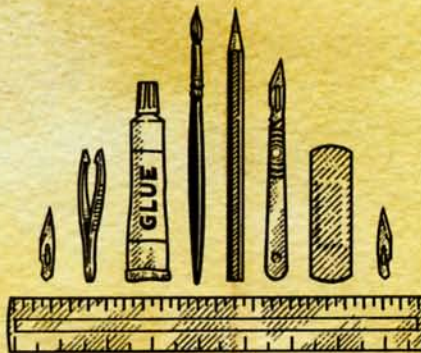

*and aske mummy before using scissors

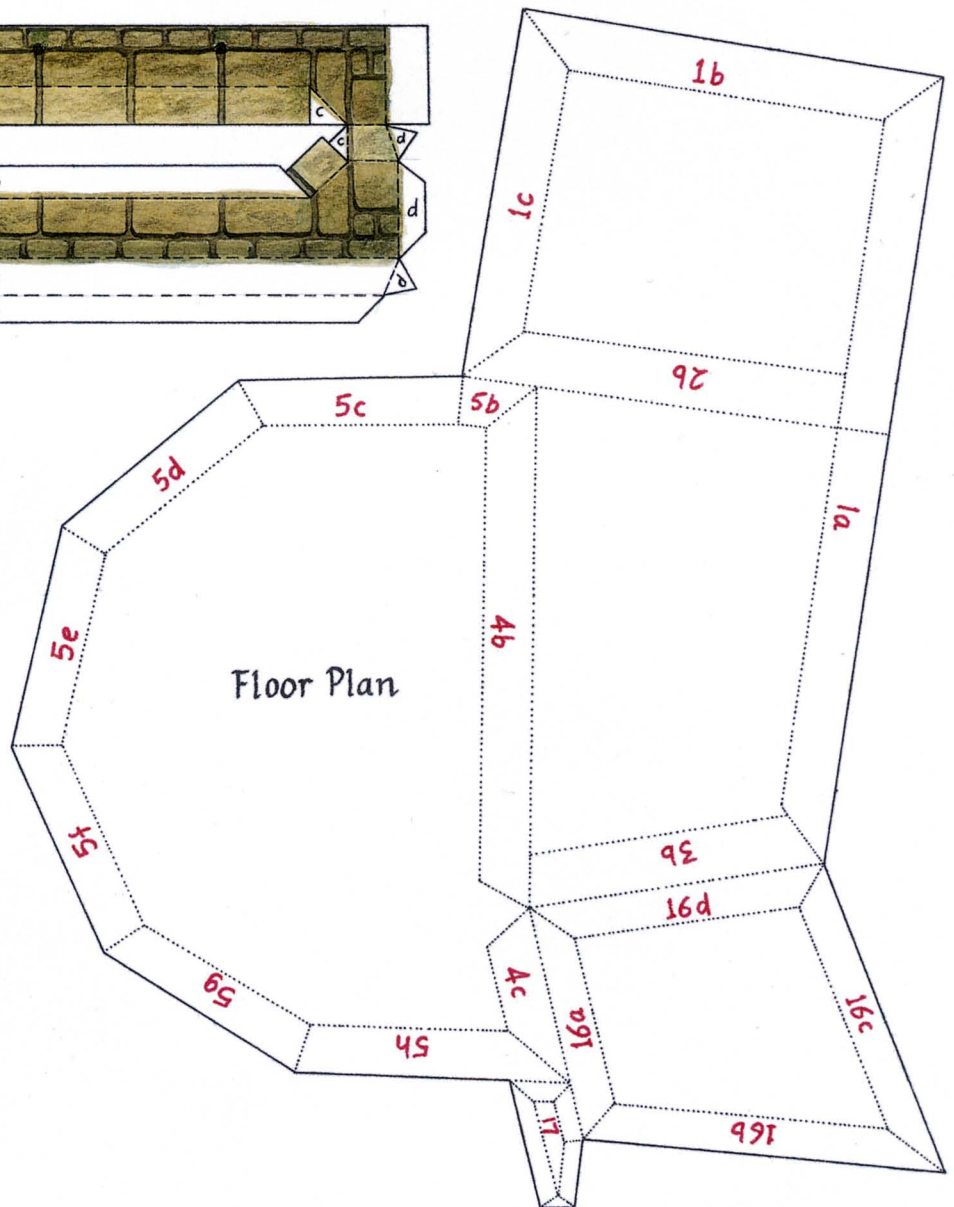
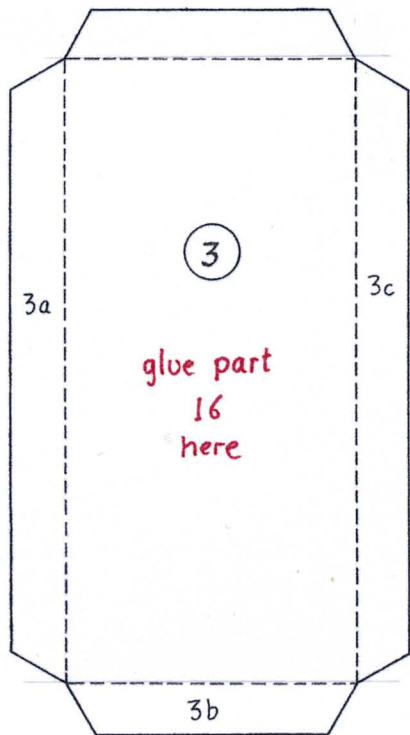
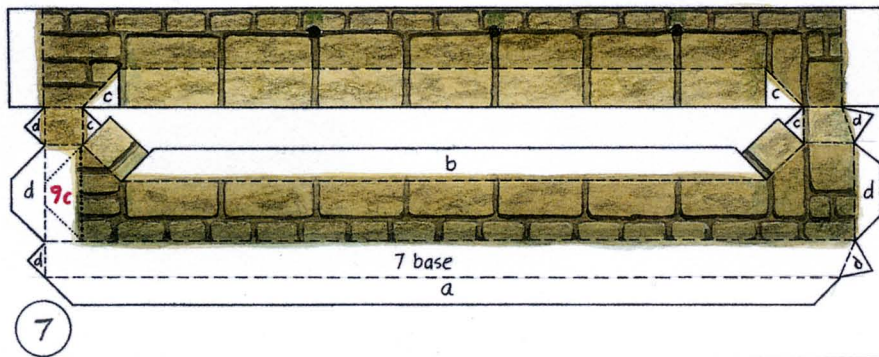
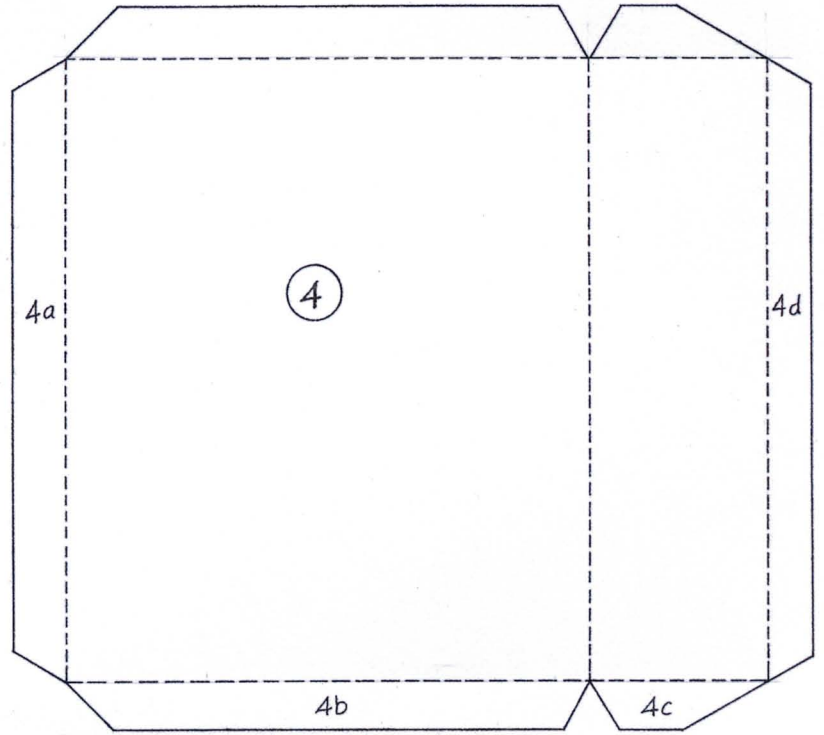
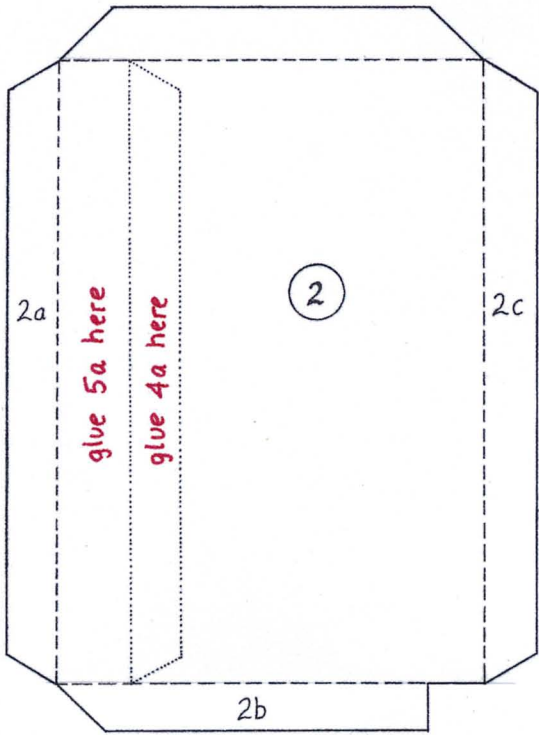

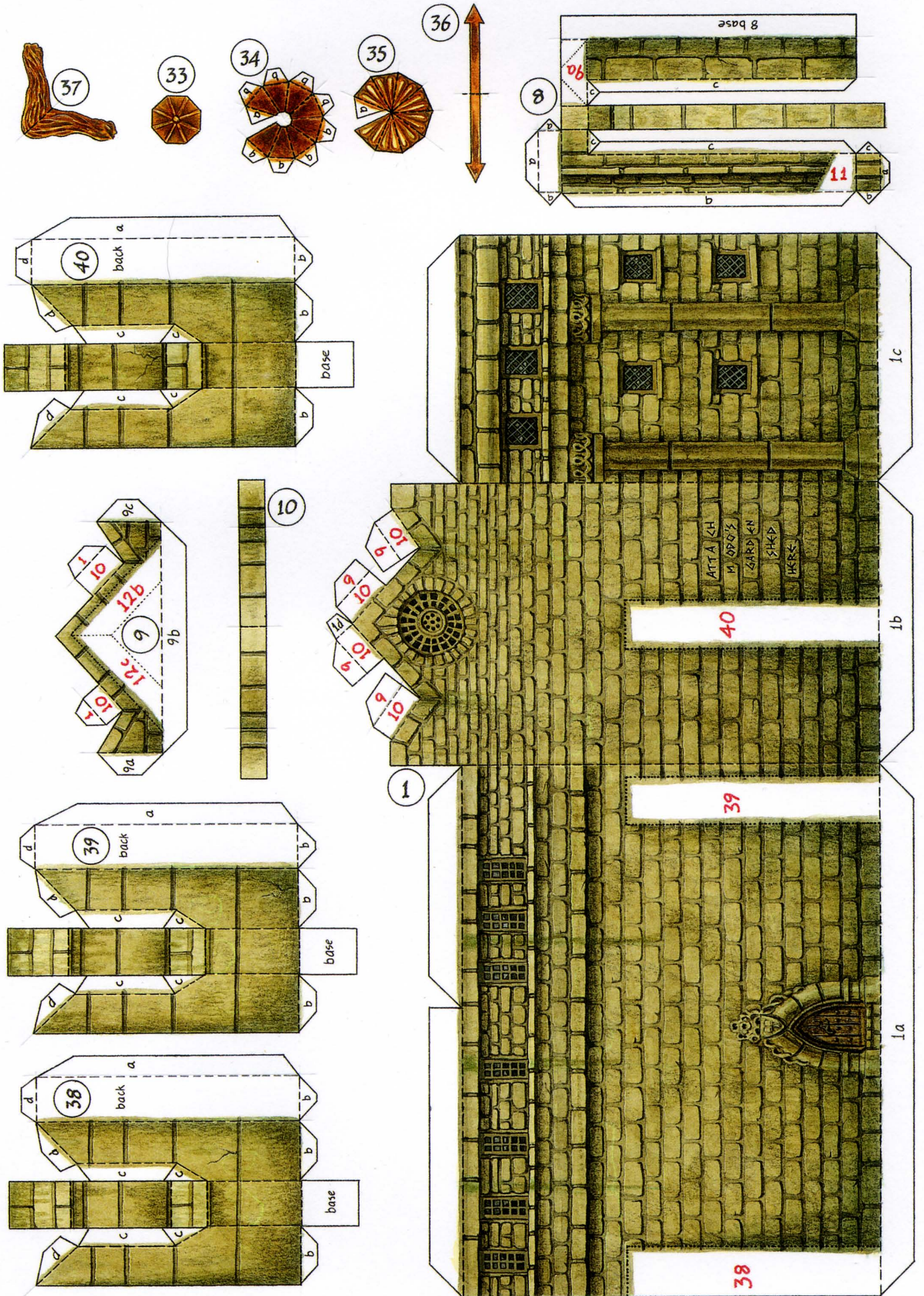

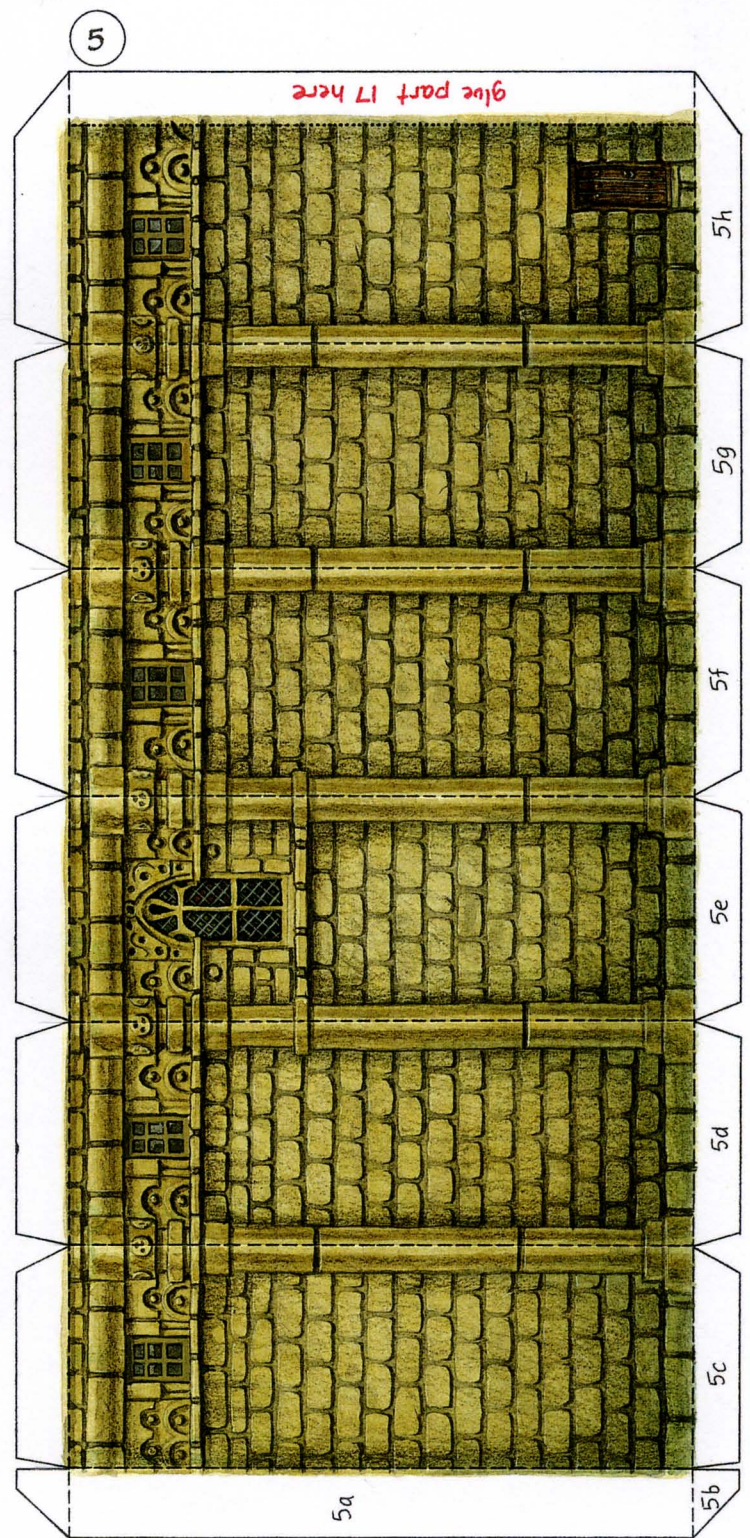
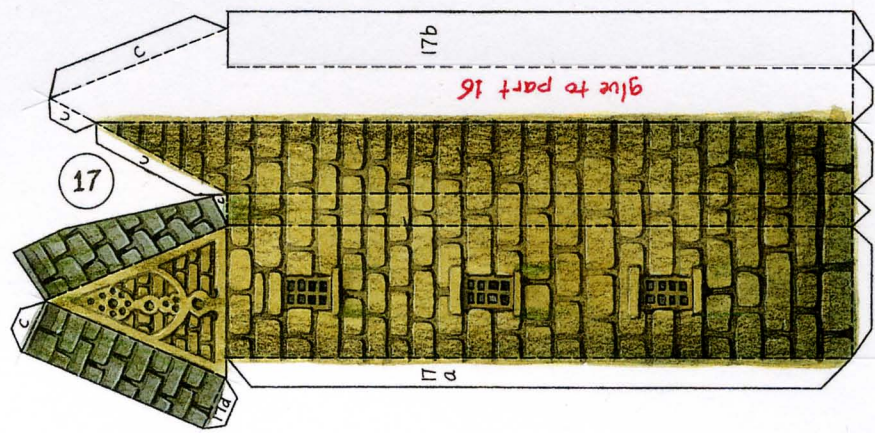
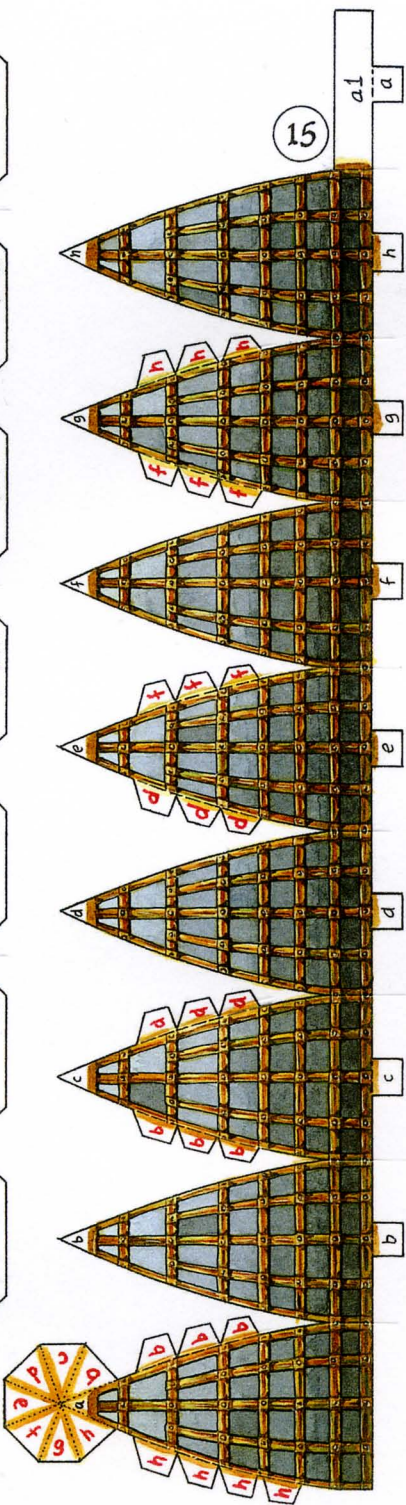
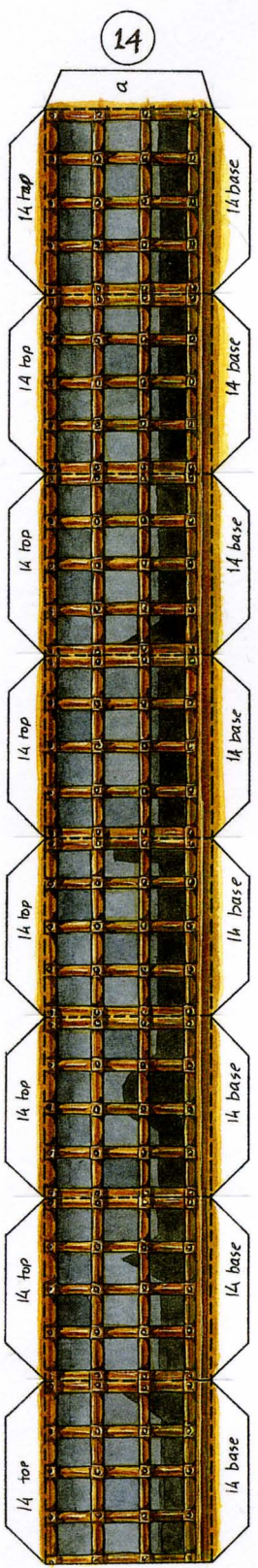

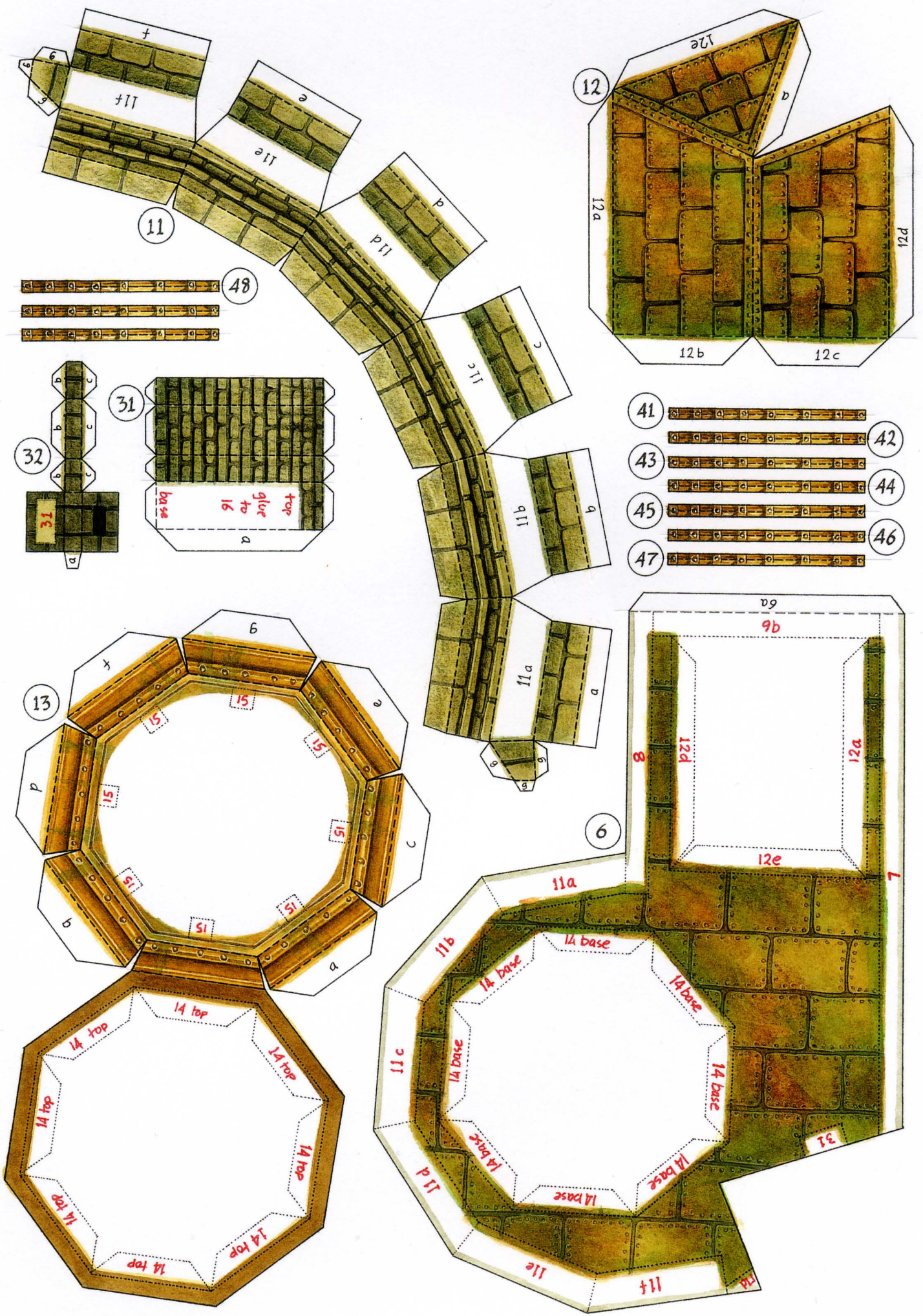

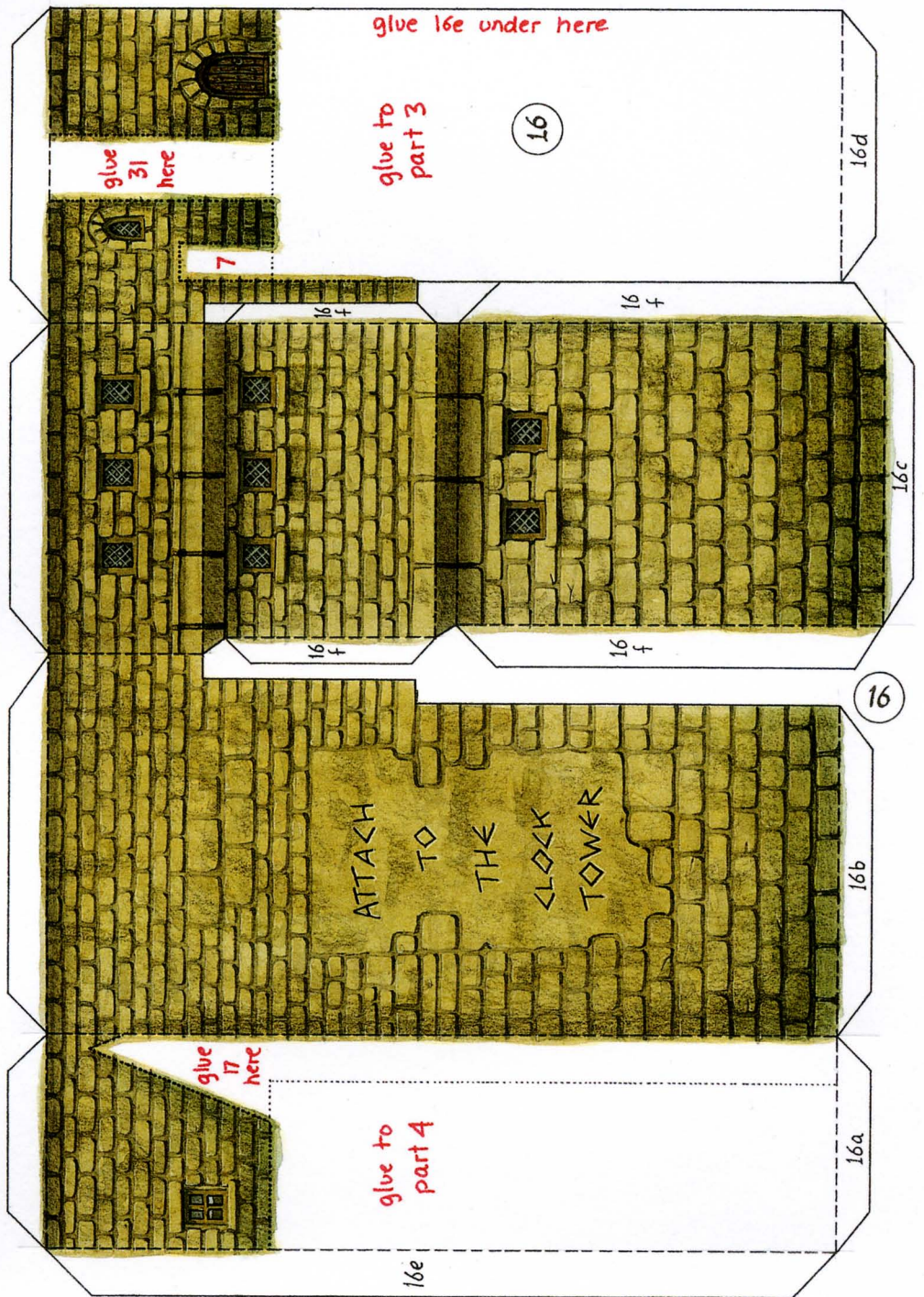
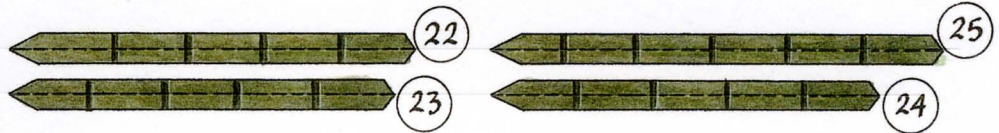
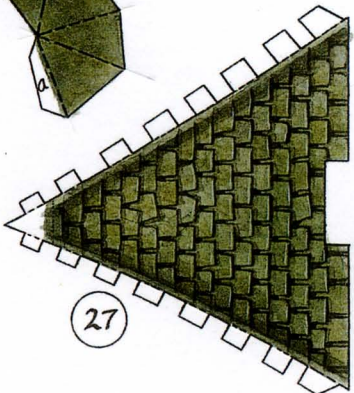
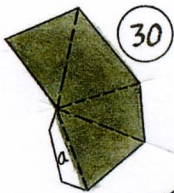
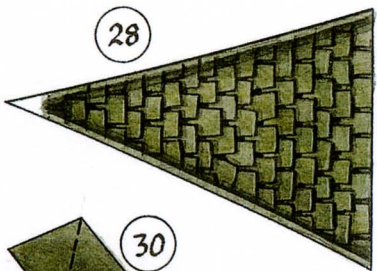
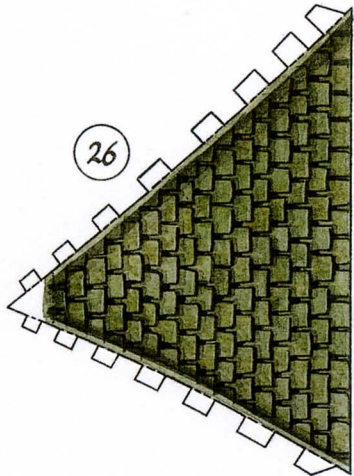
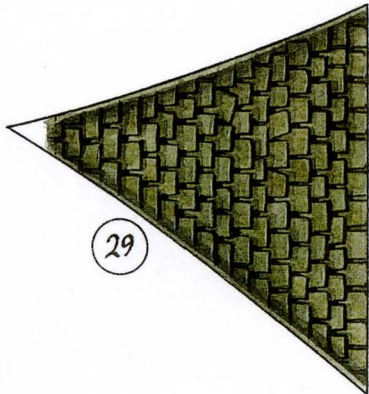
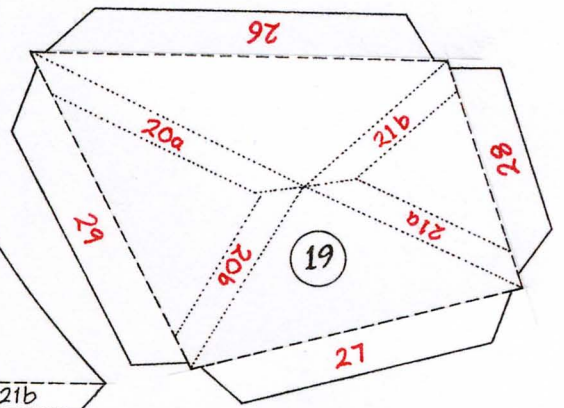
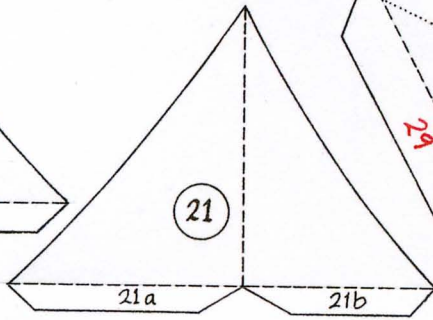
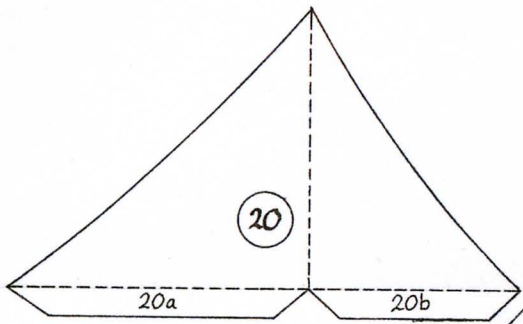

THE BOAT HOUSE

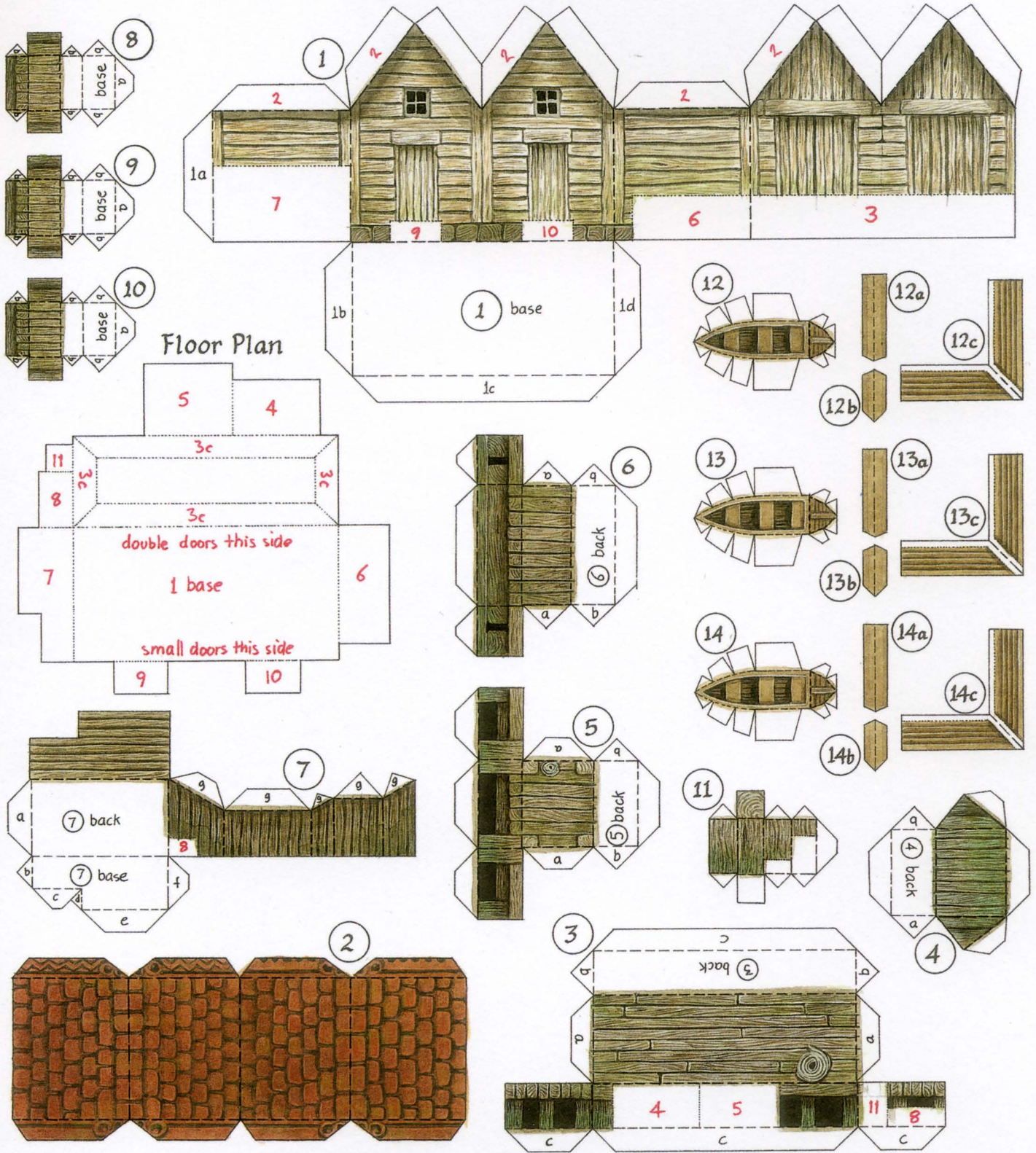

MODO'S GARDEN SHED

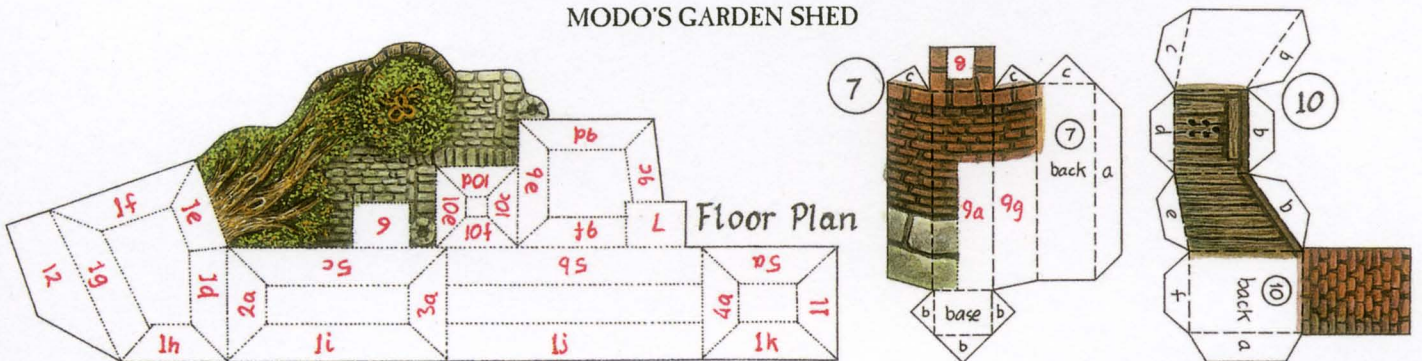

MODO'S GARDEN SHED continued

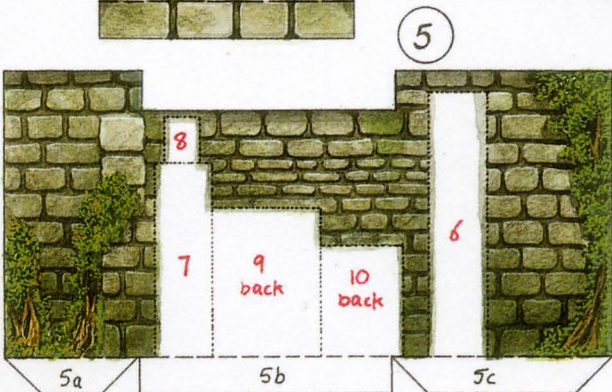
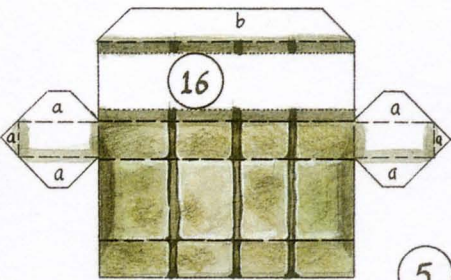
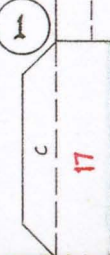
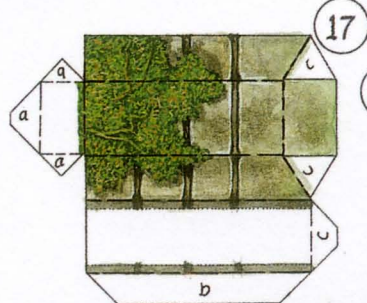
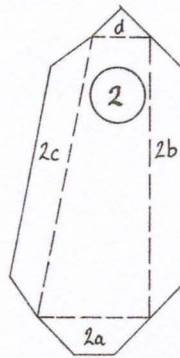
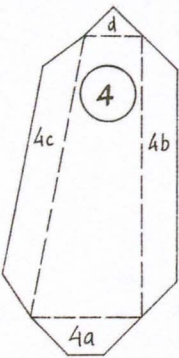
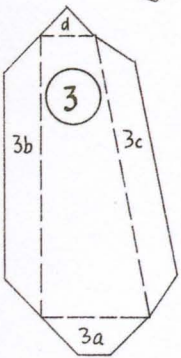
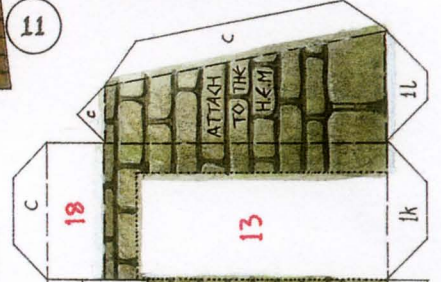
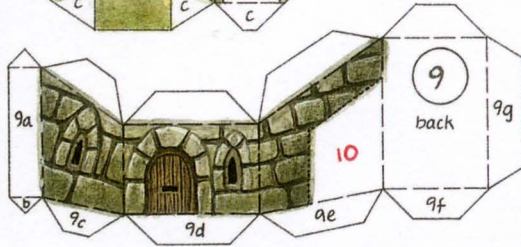
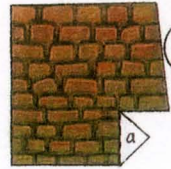
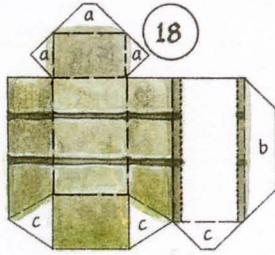
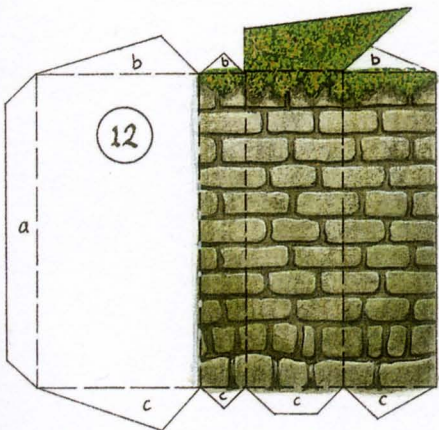
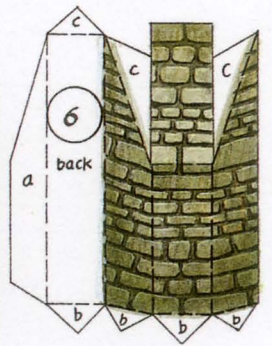
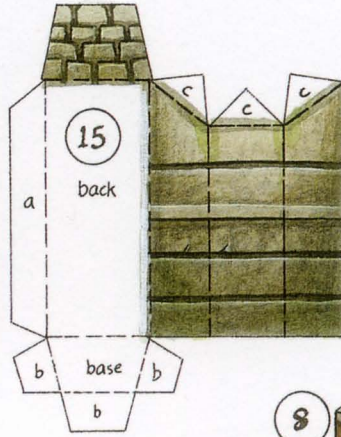
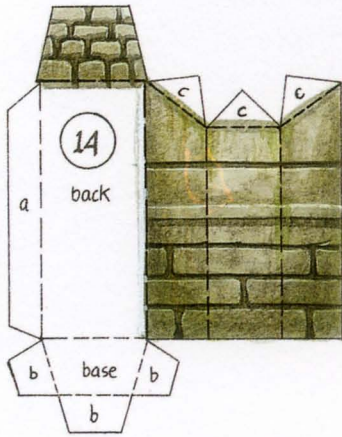
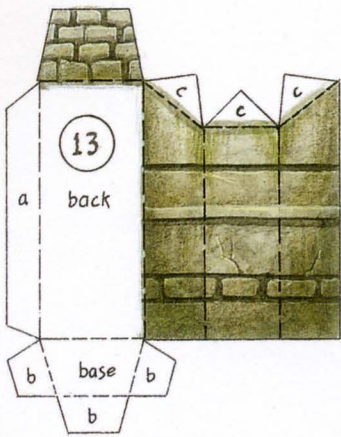

RIVER WALL

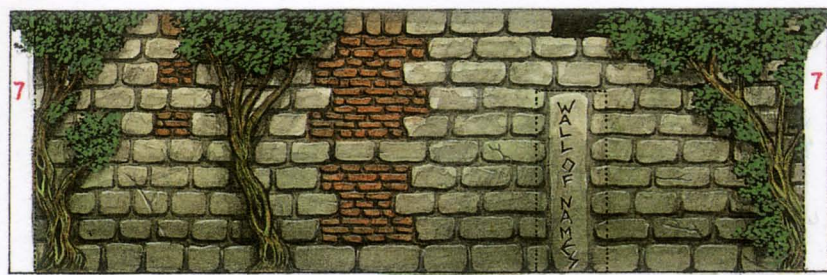

1

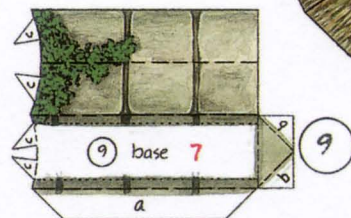
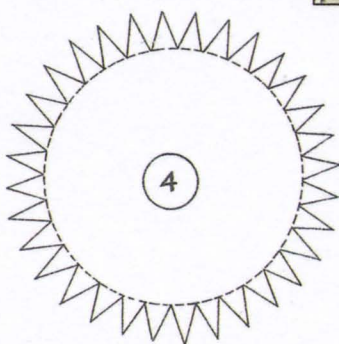
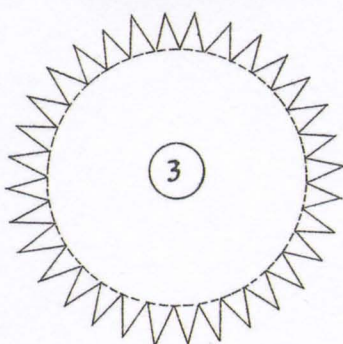
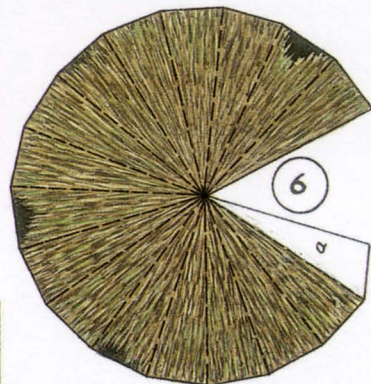
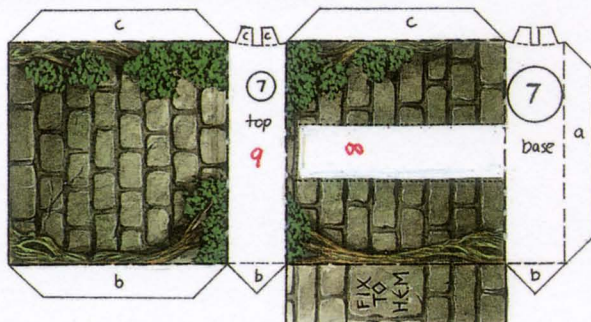
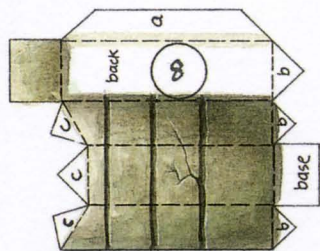
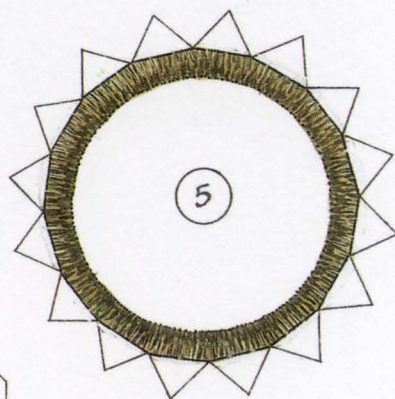
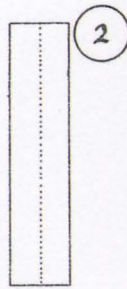

WALL OF NAMES

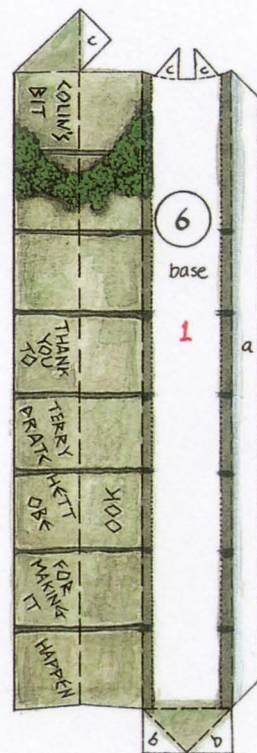
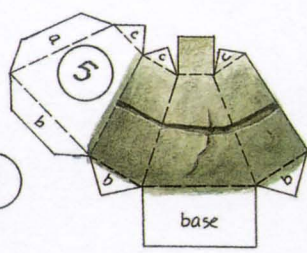
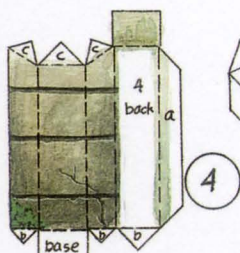
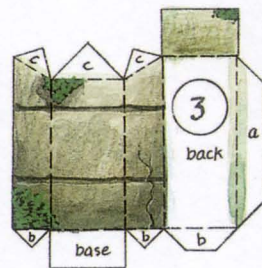
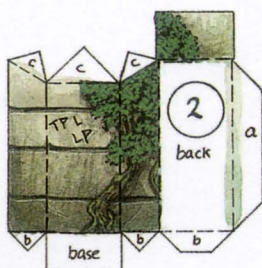
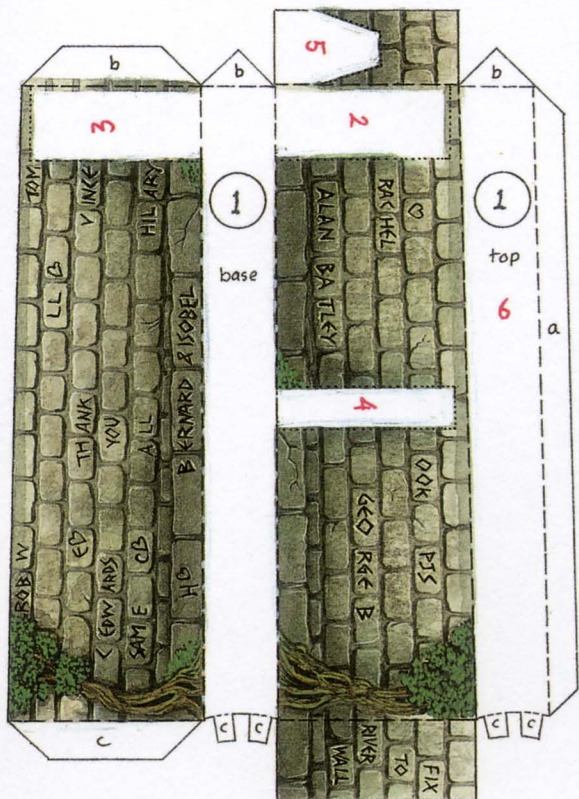

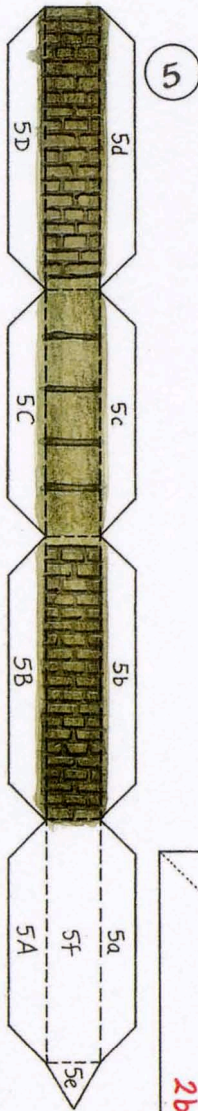
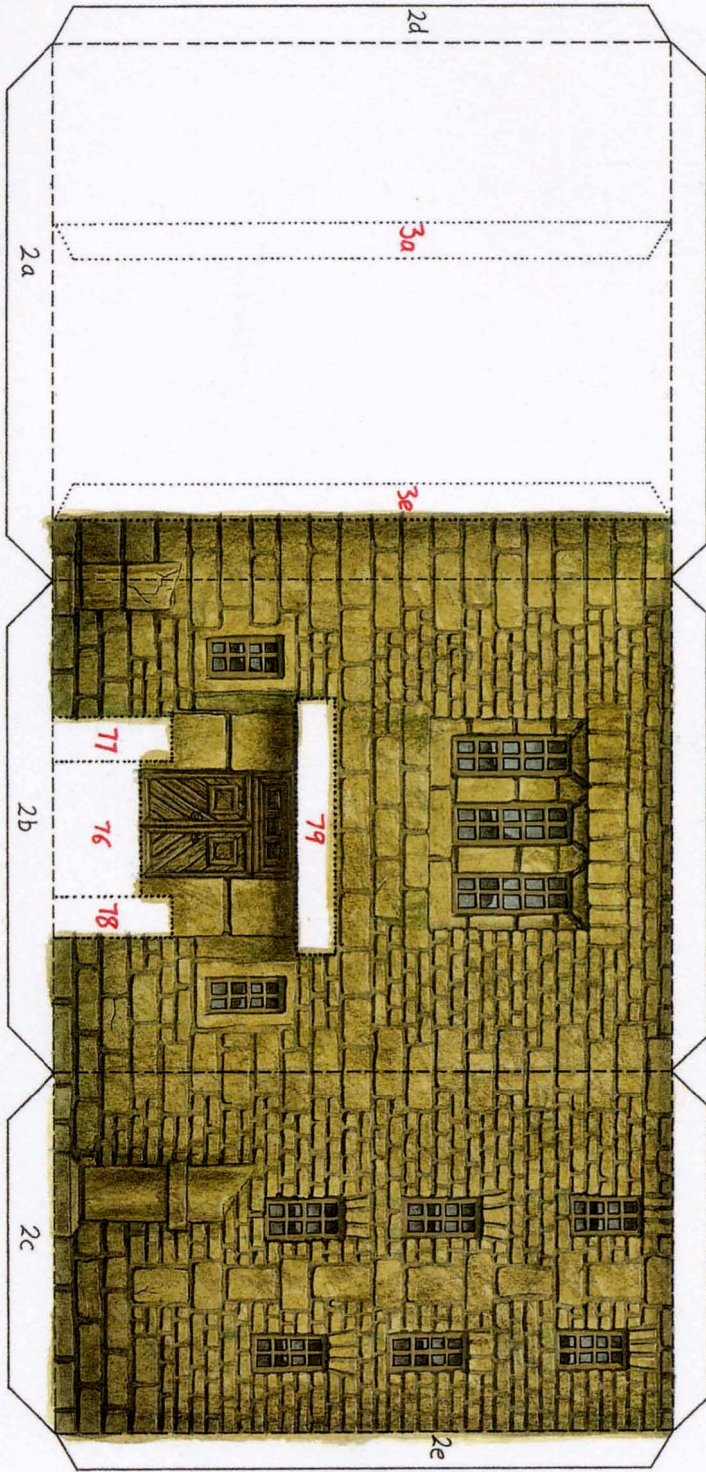

2

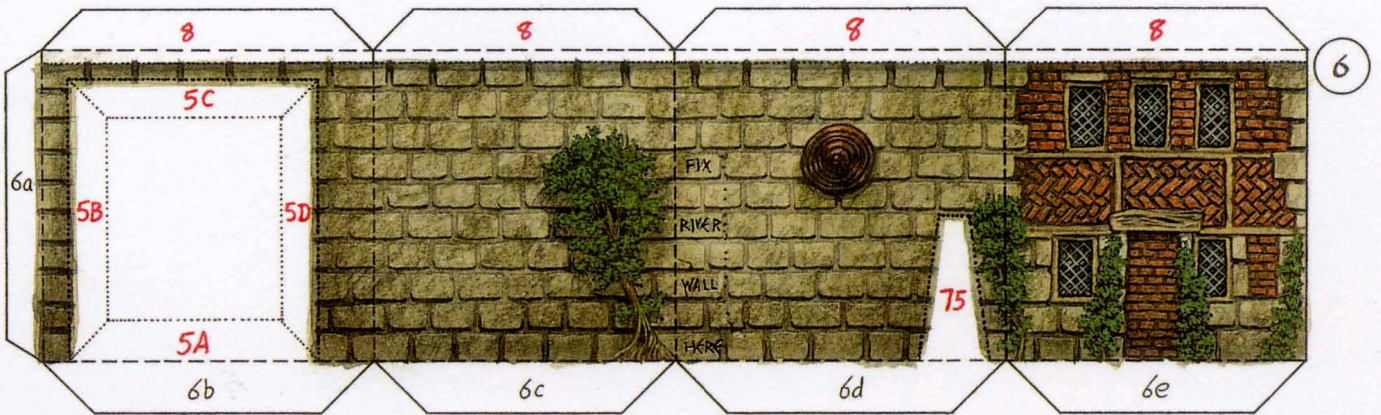
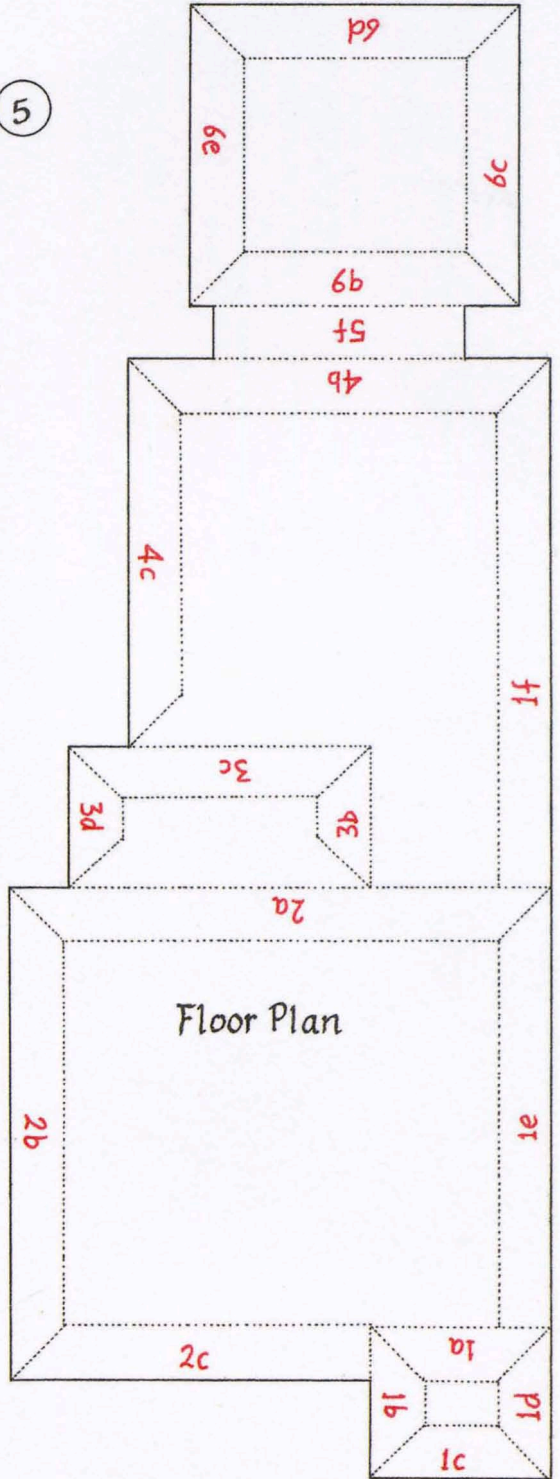

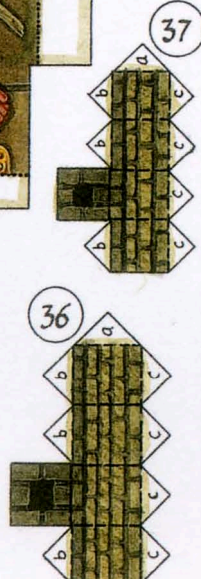
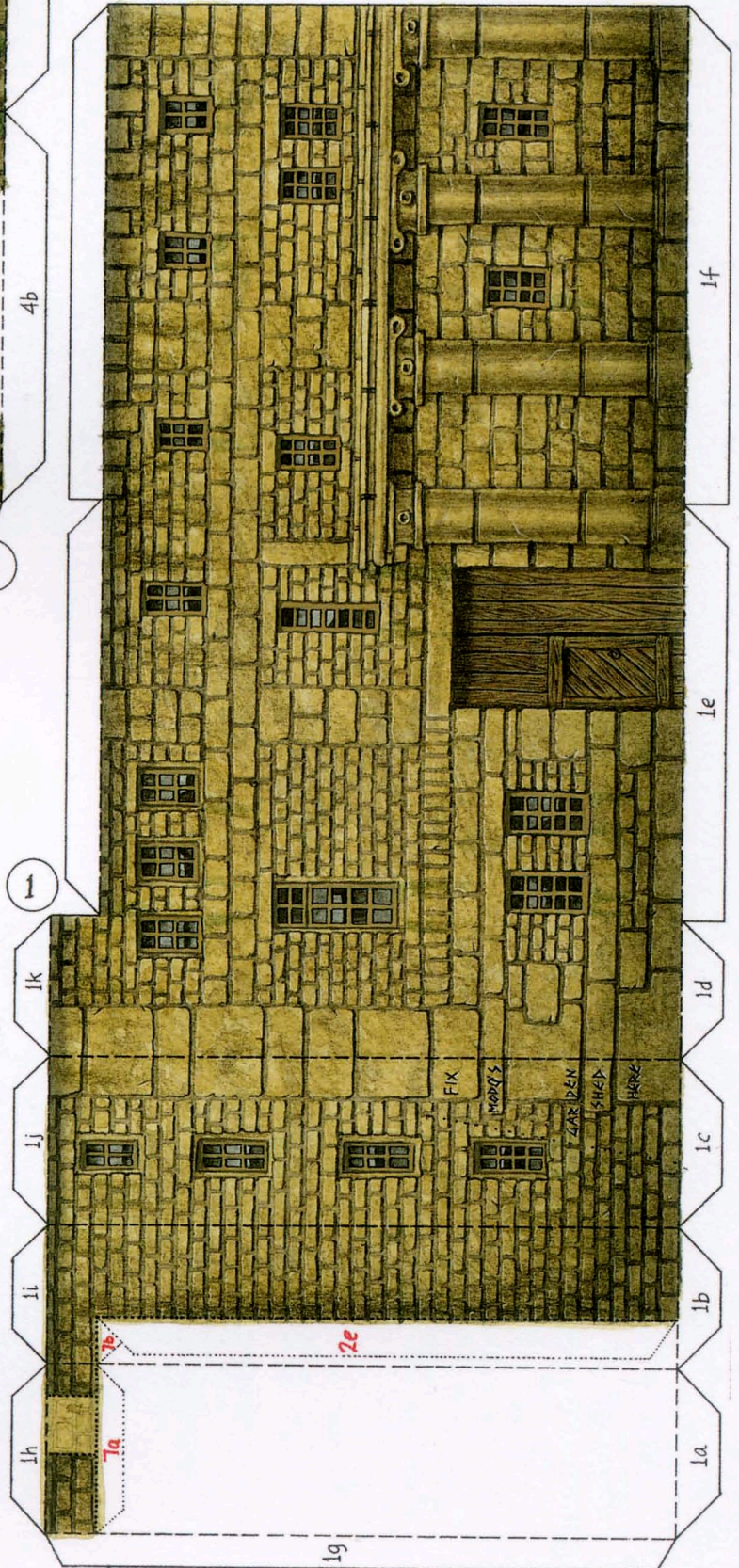
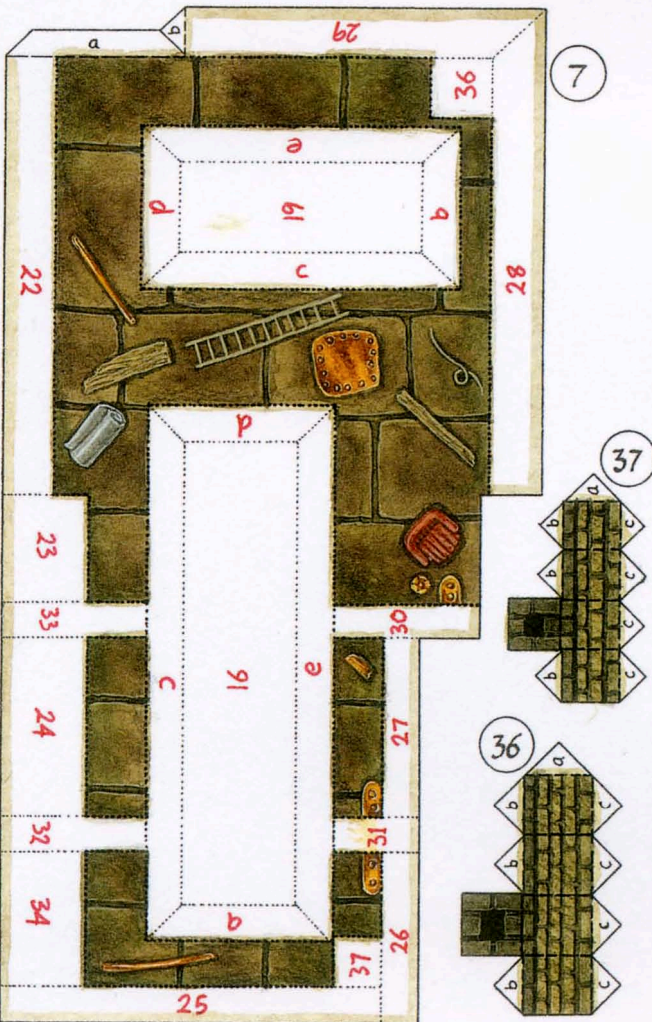
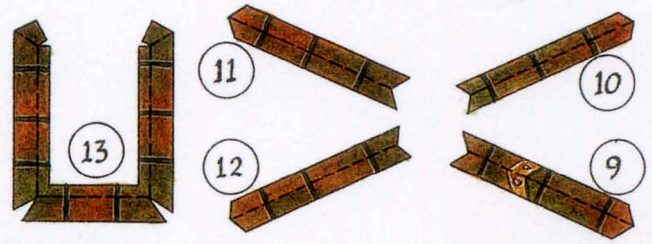
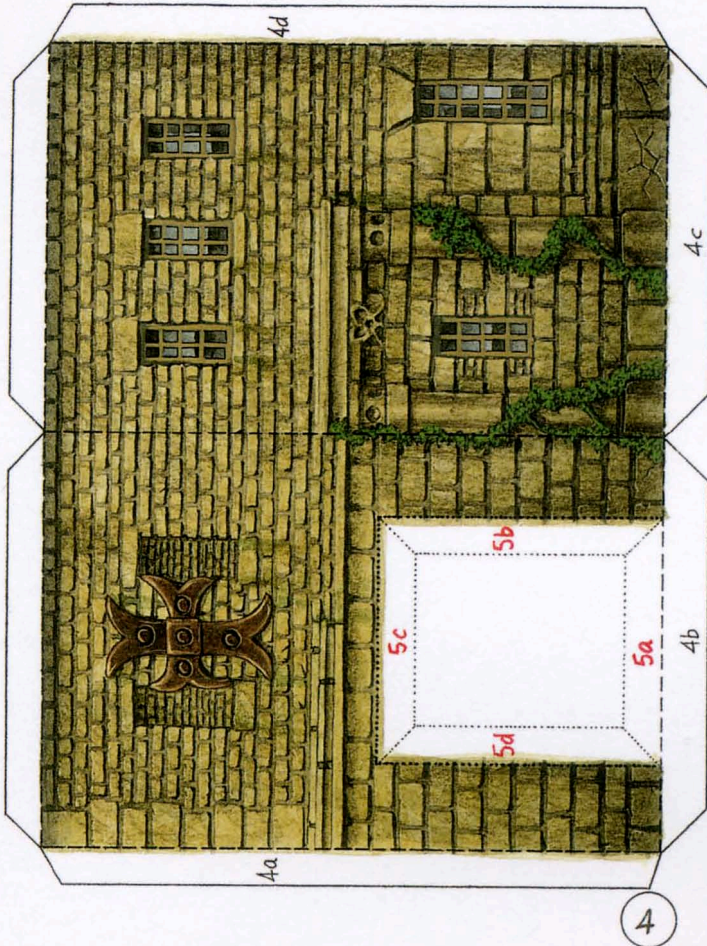

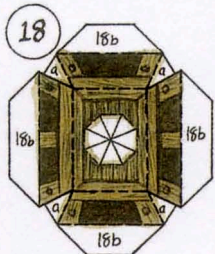
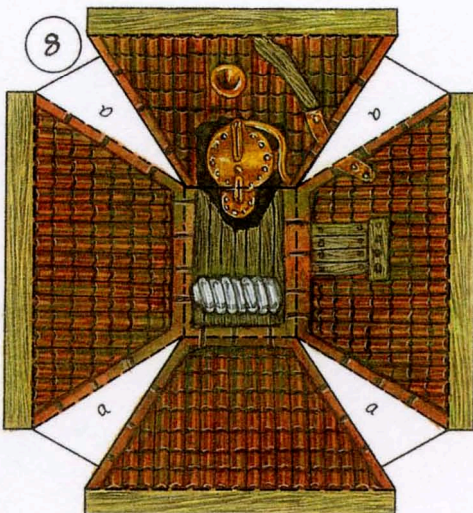
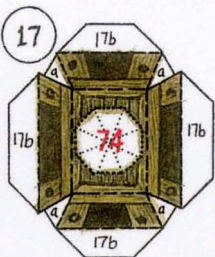
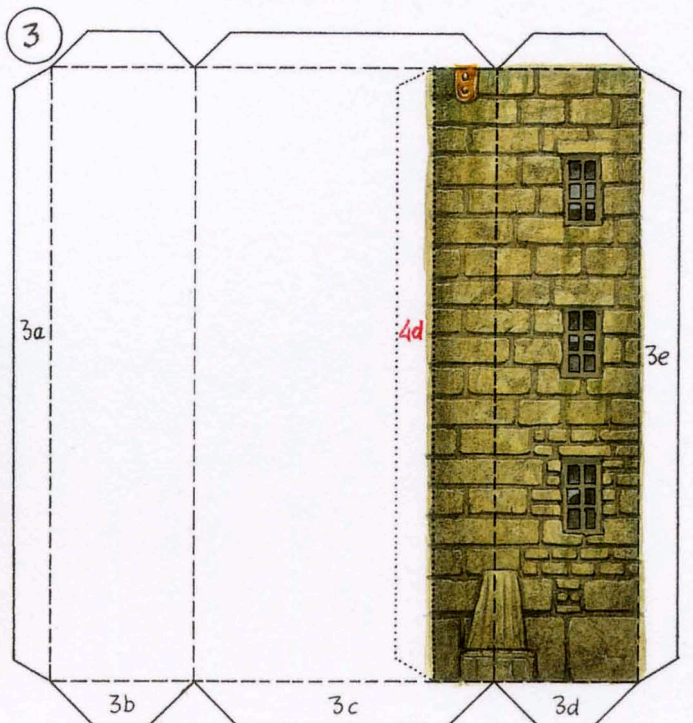
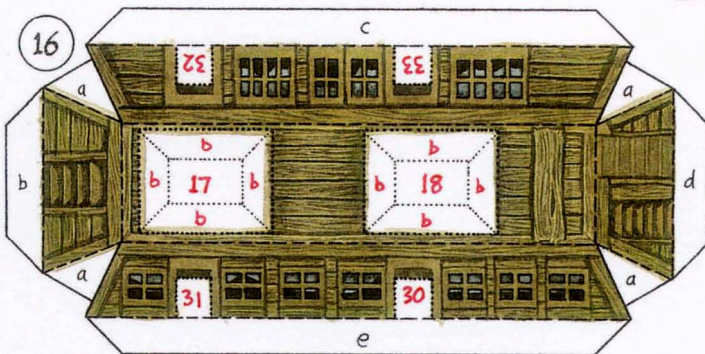
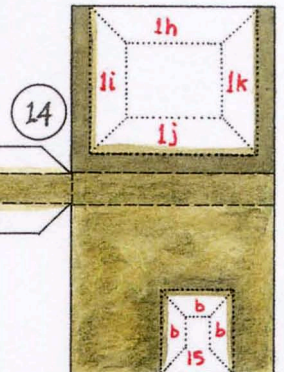
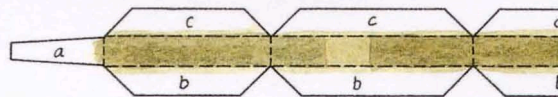
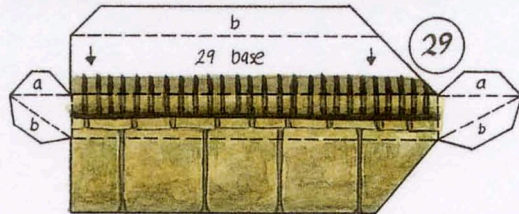
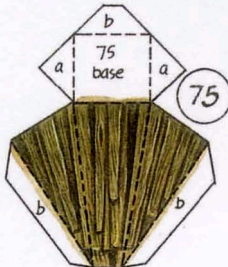
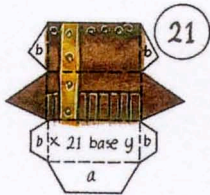
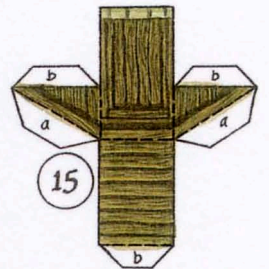
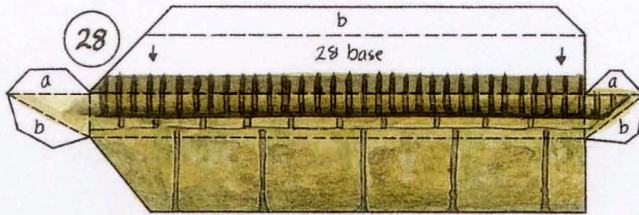
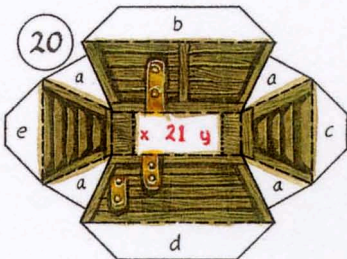
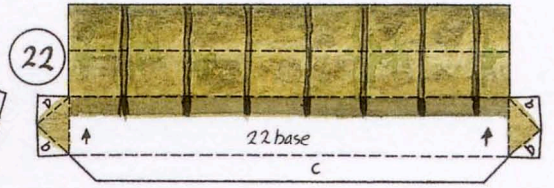
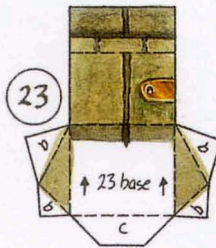
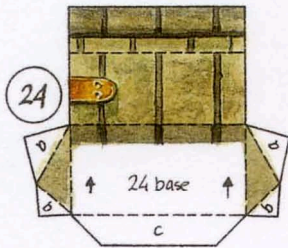
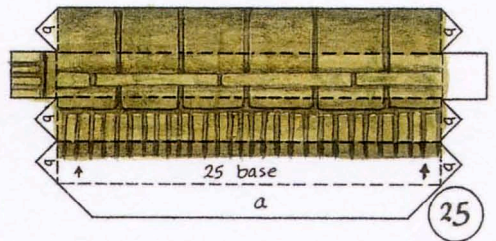
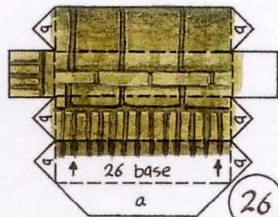
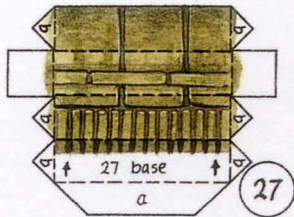
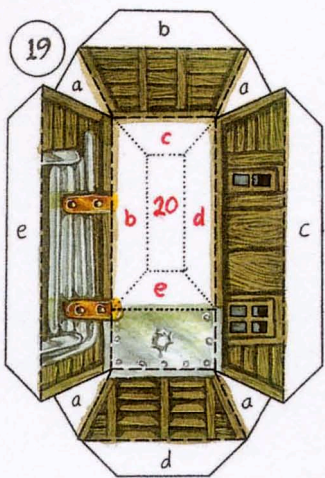

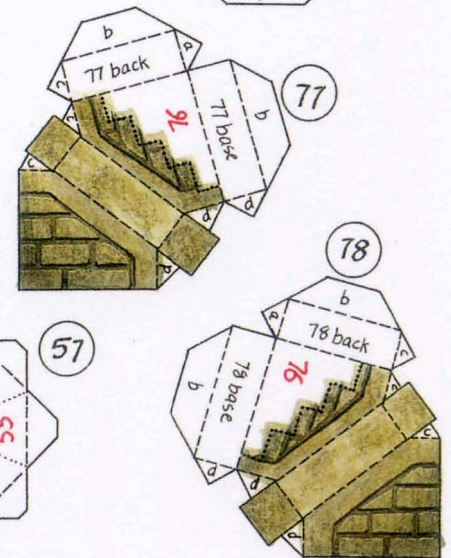
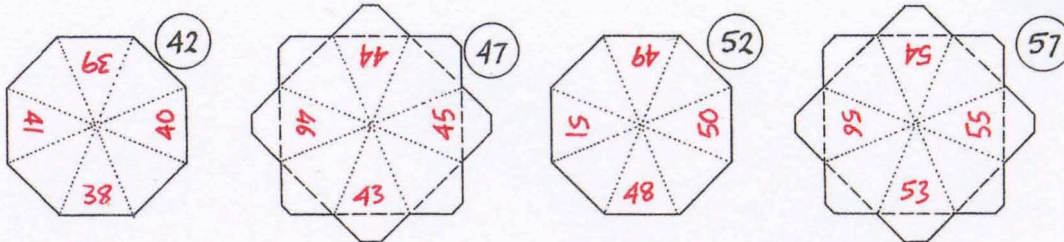
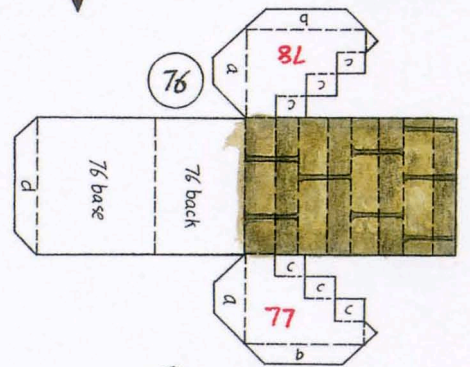
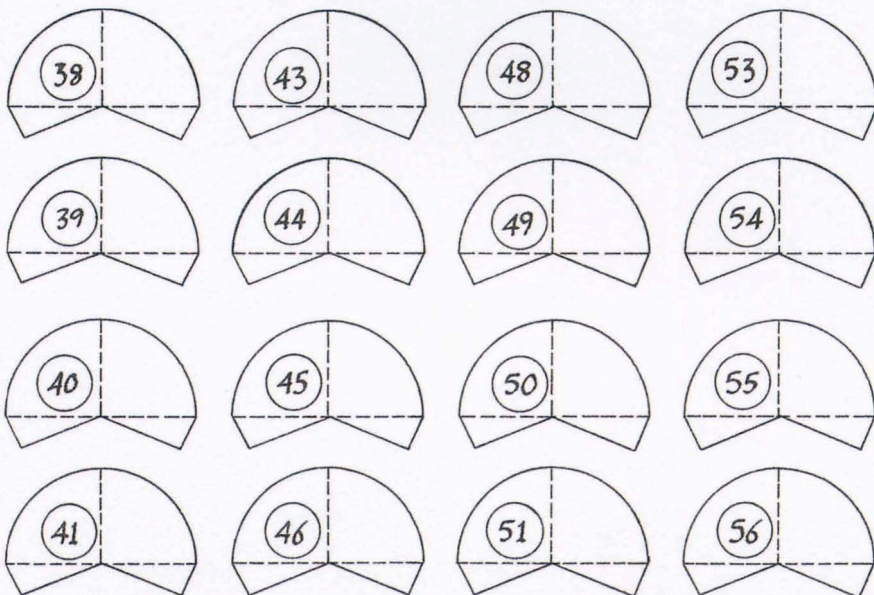
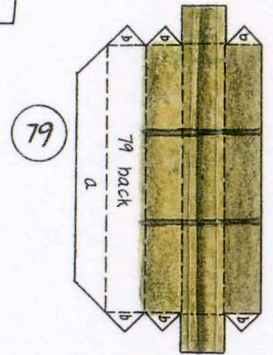
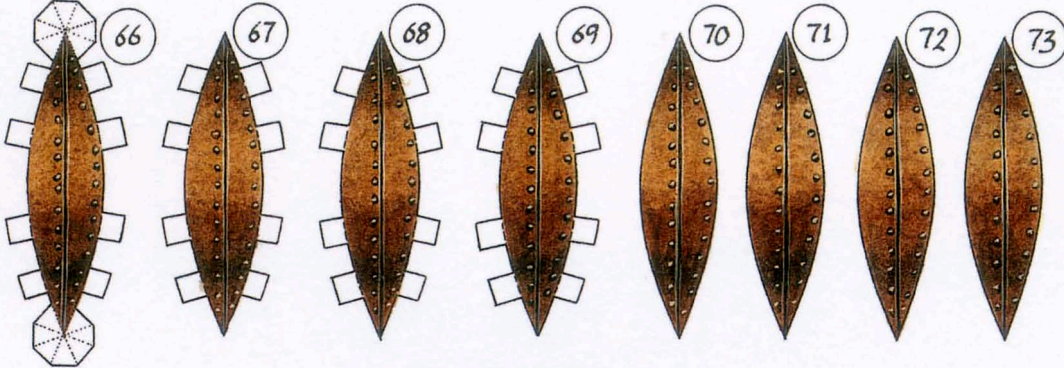
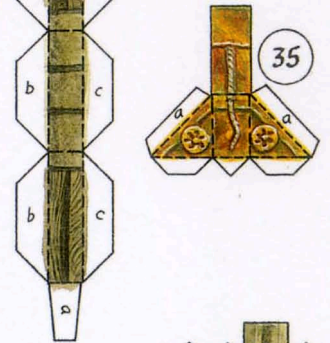
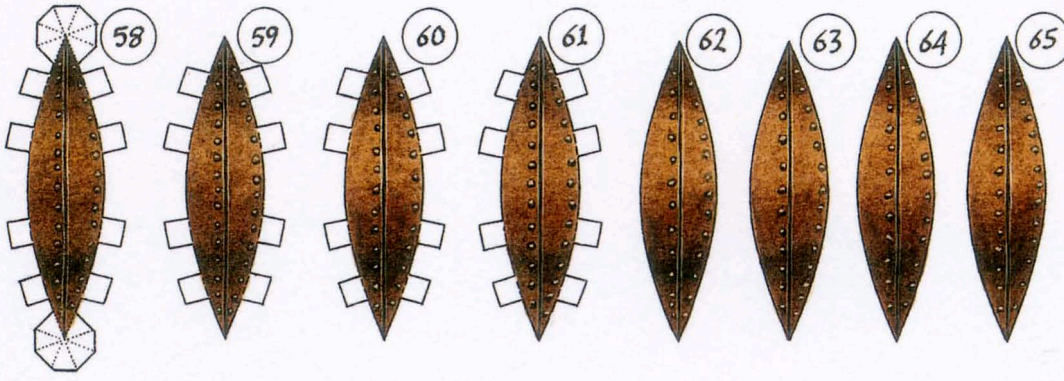
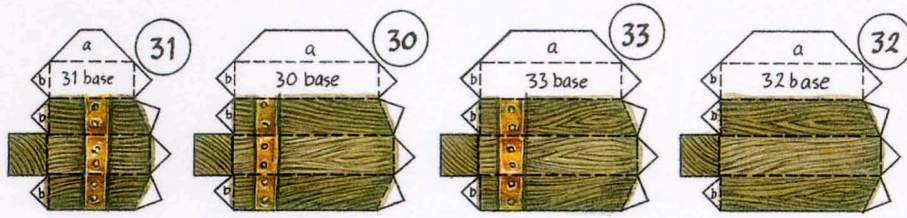

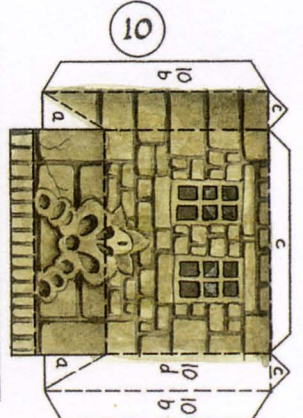
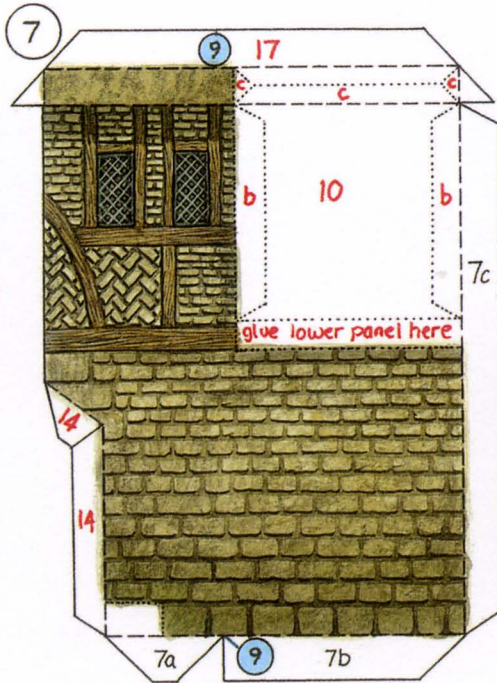
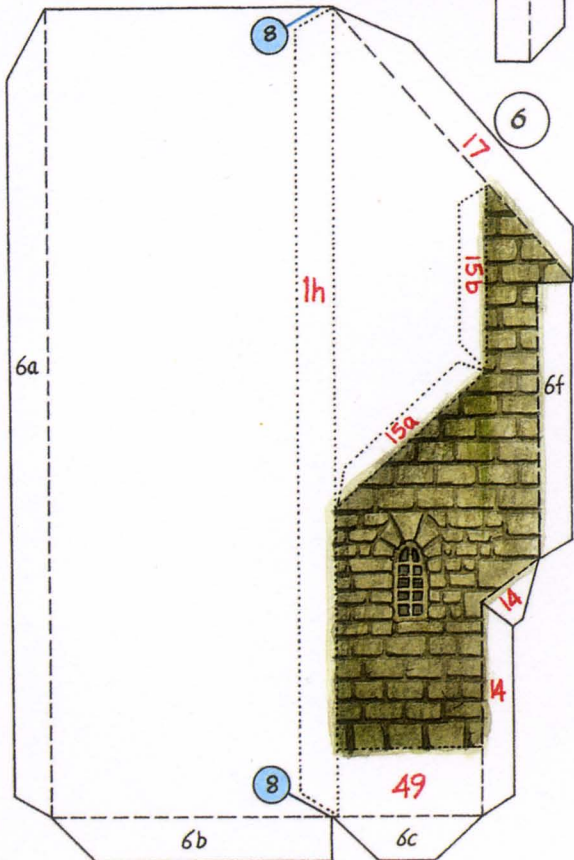
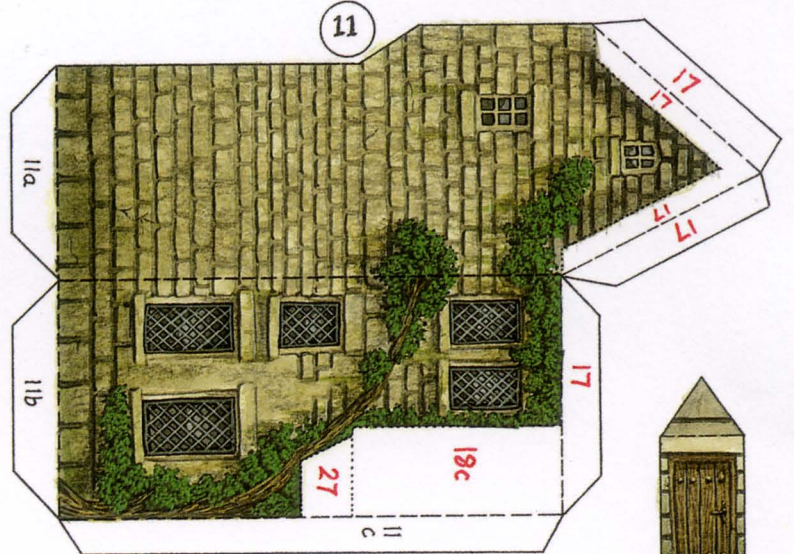
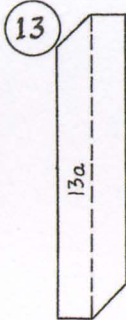
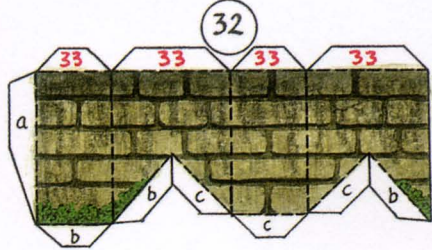
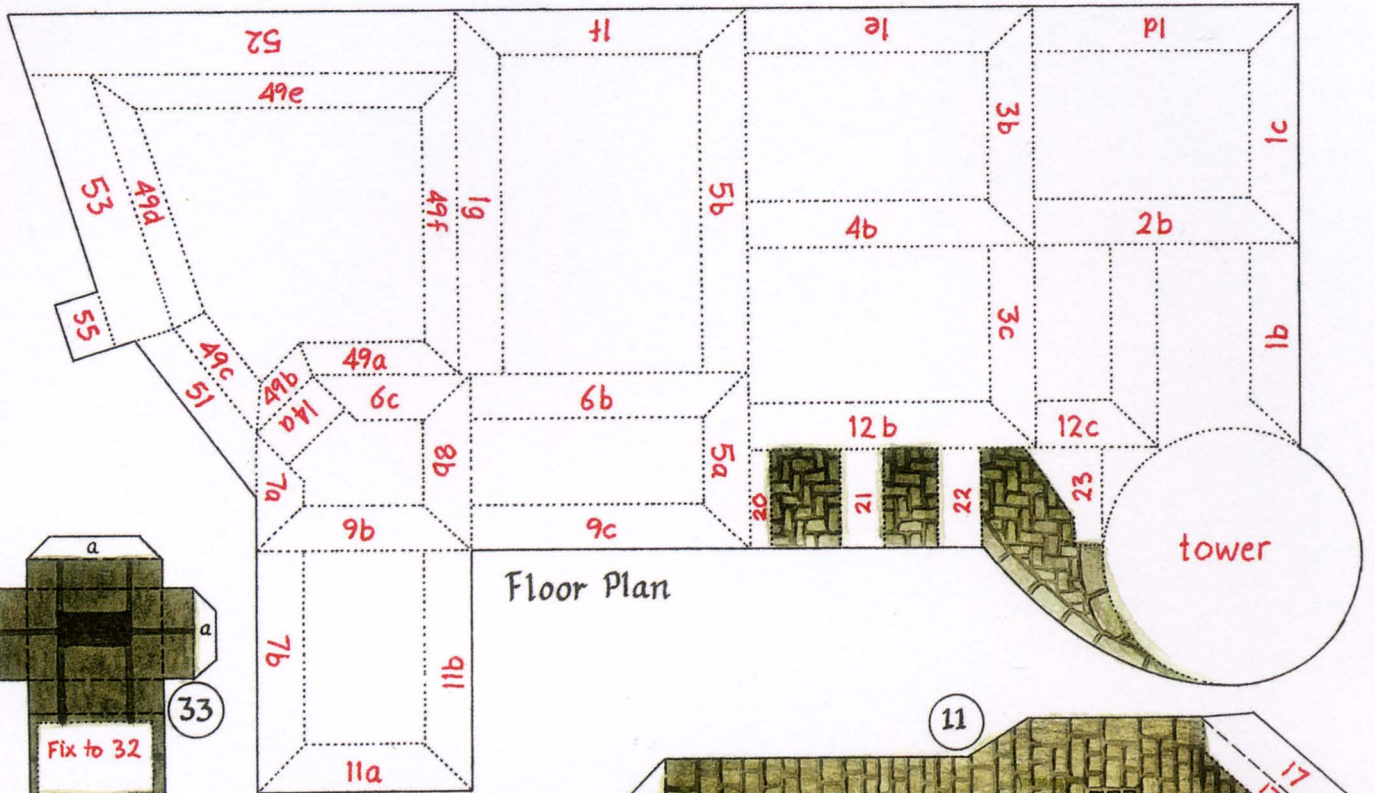

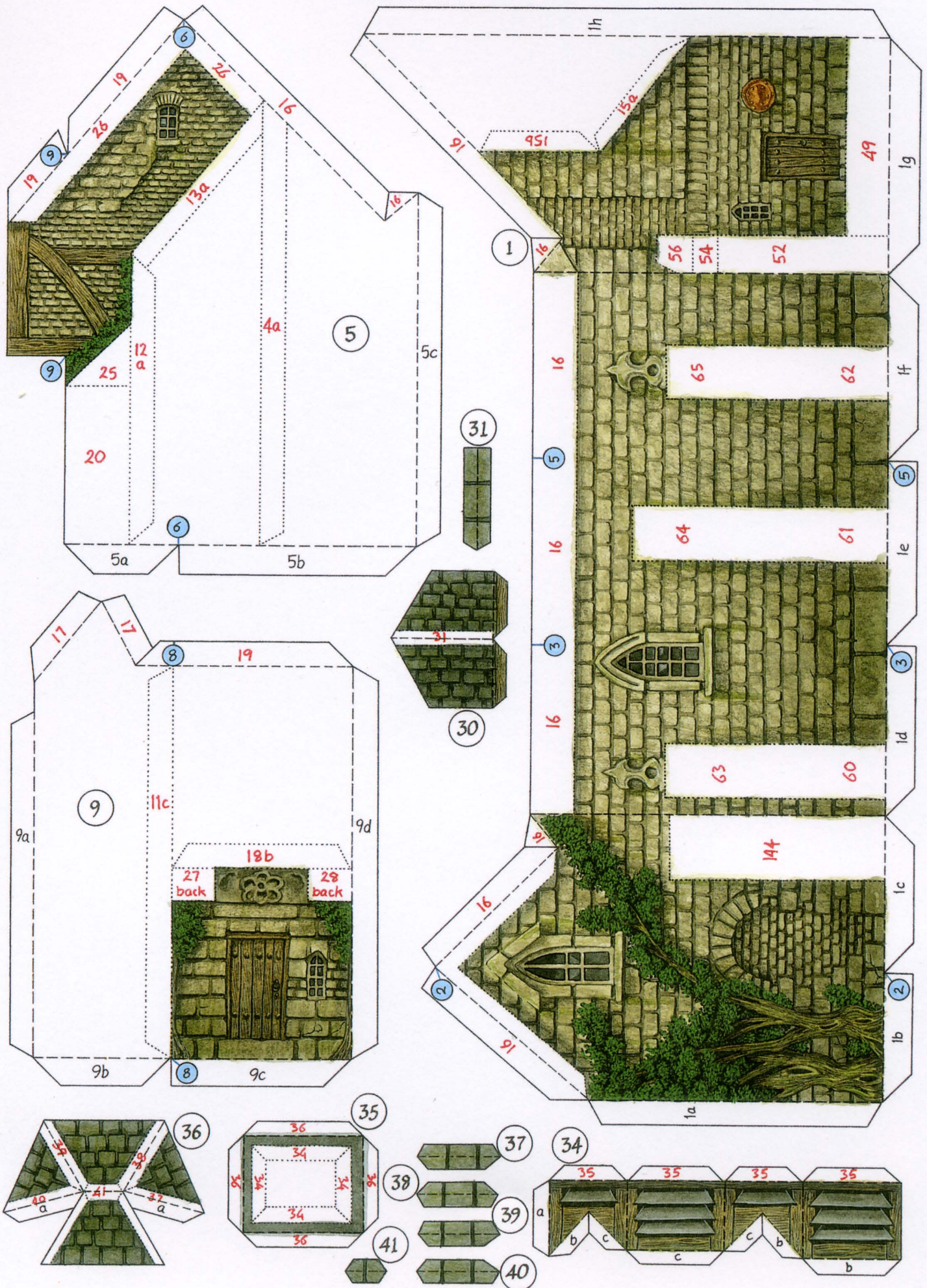

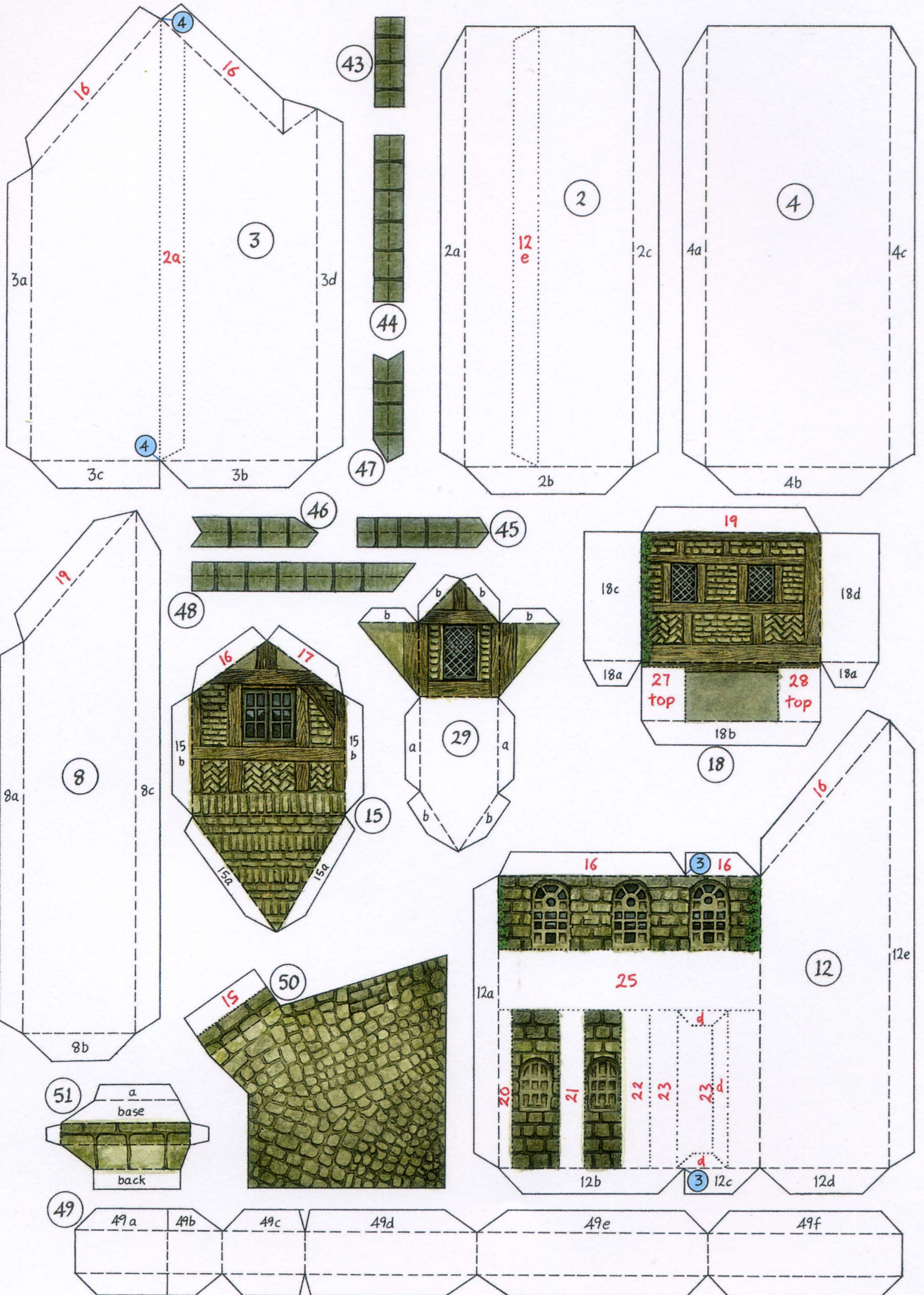

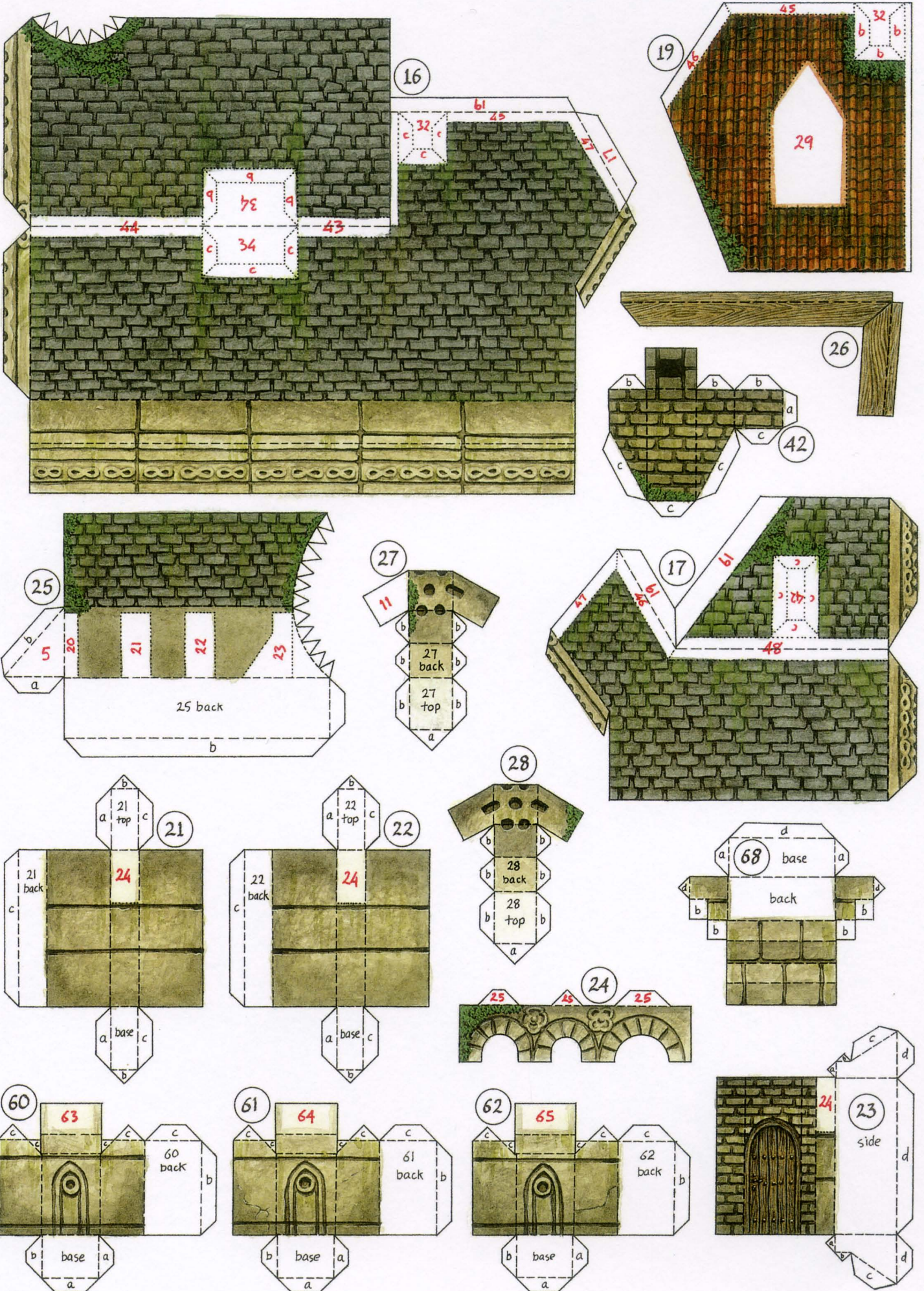

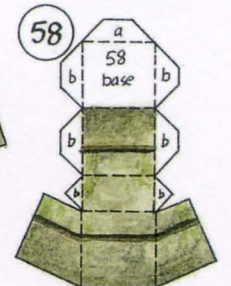
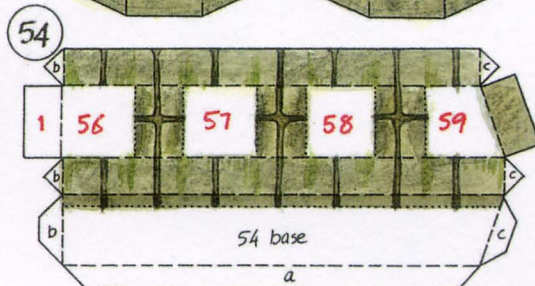
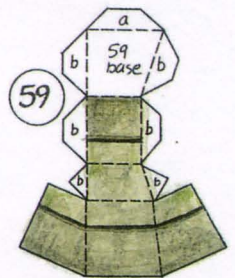
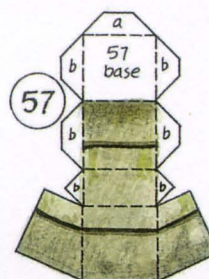
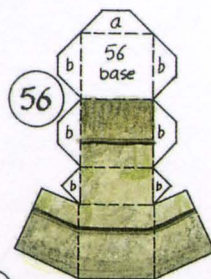
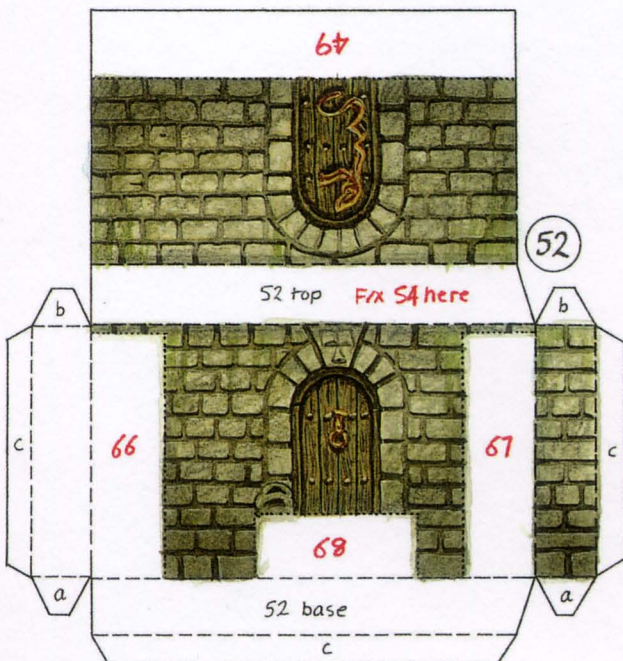
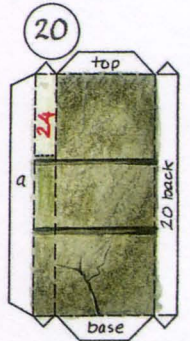
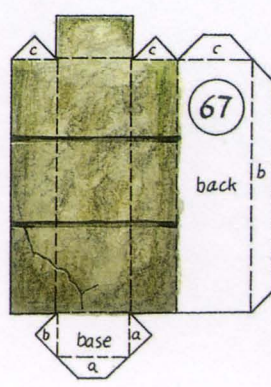
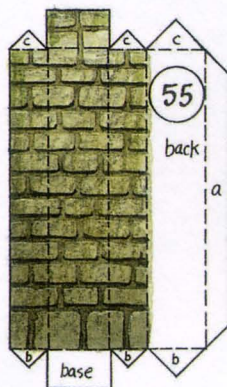
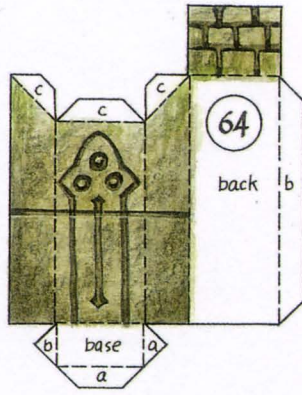
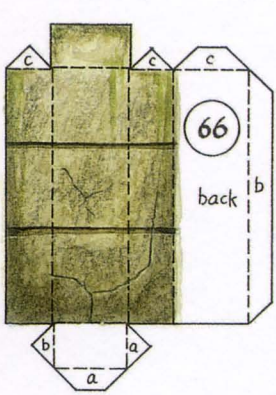
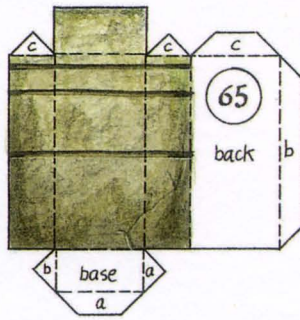
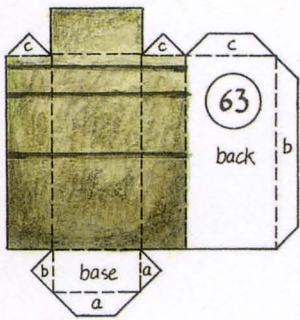
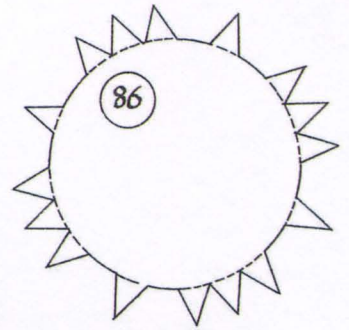
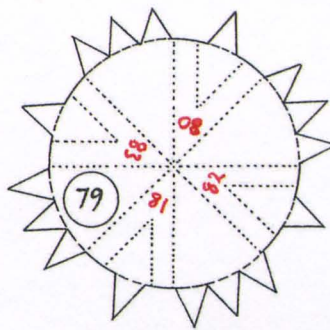
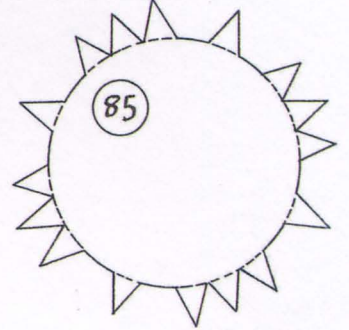
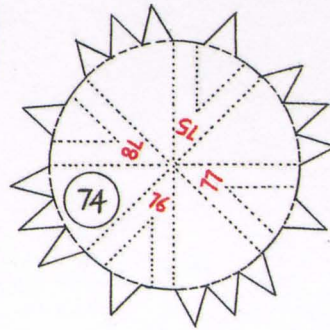
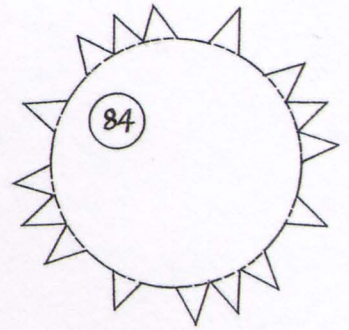
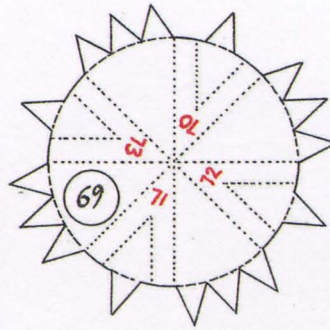
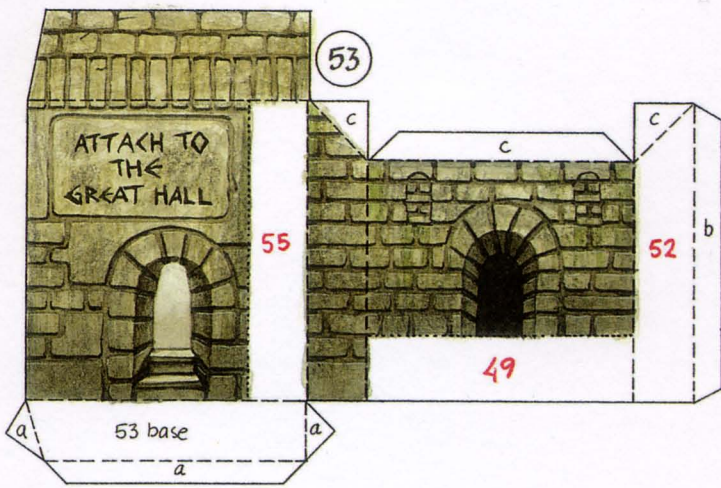

91

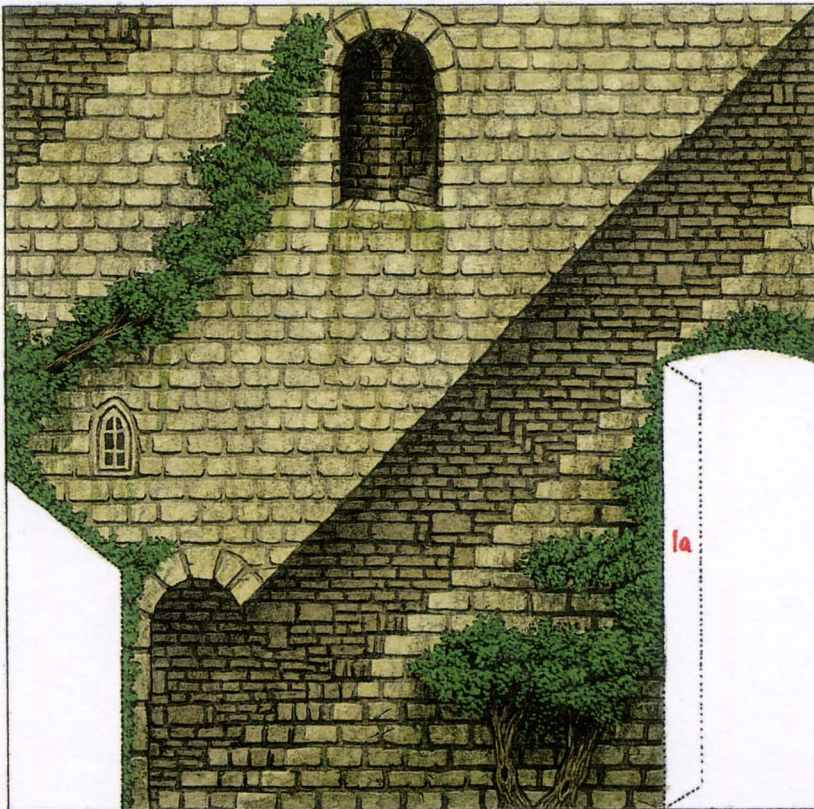

87

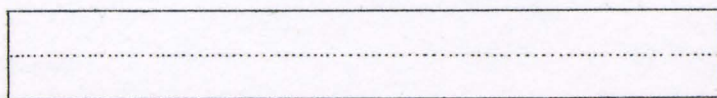

89

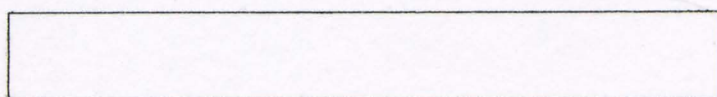

90

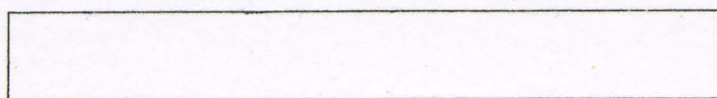

93

92

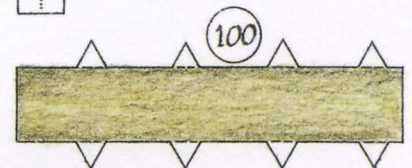
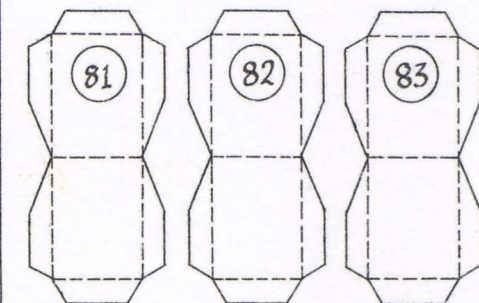
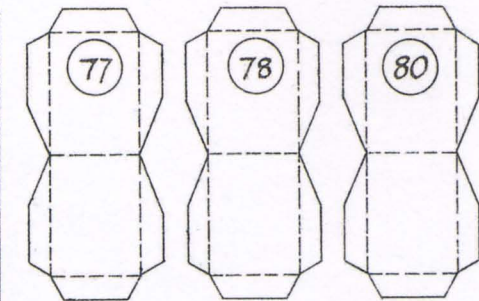
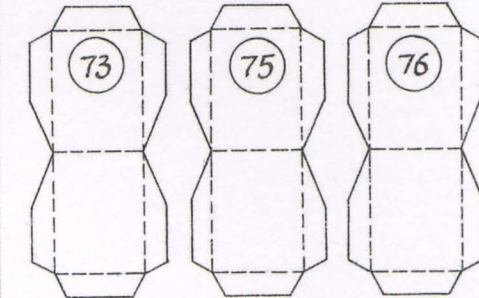
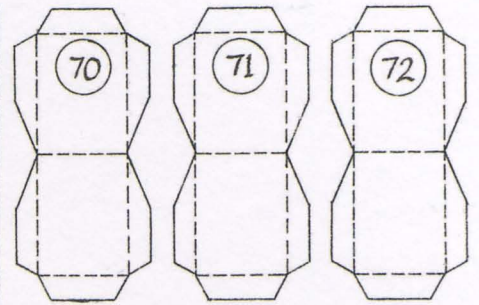
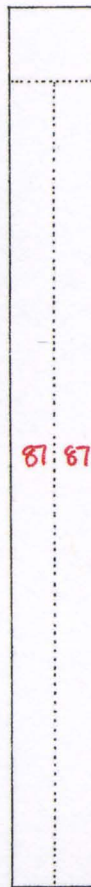
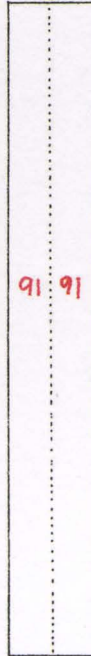

88

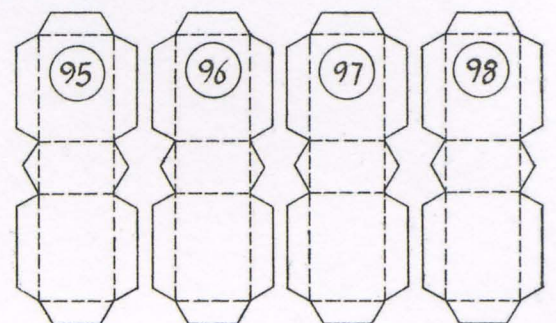

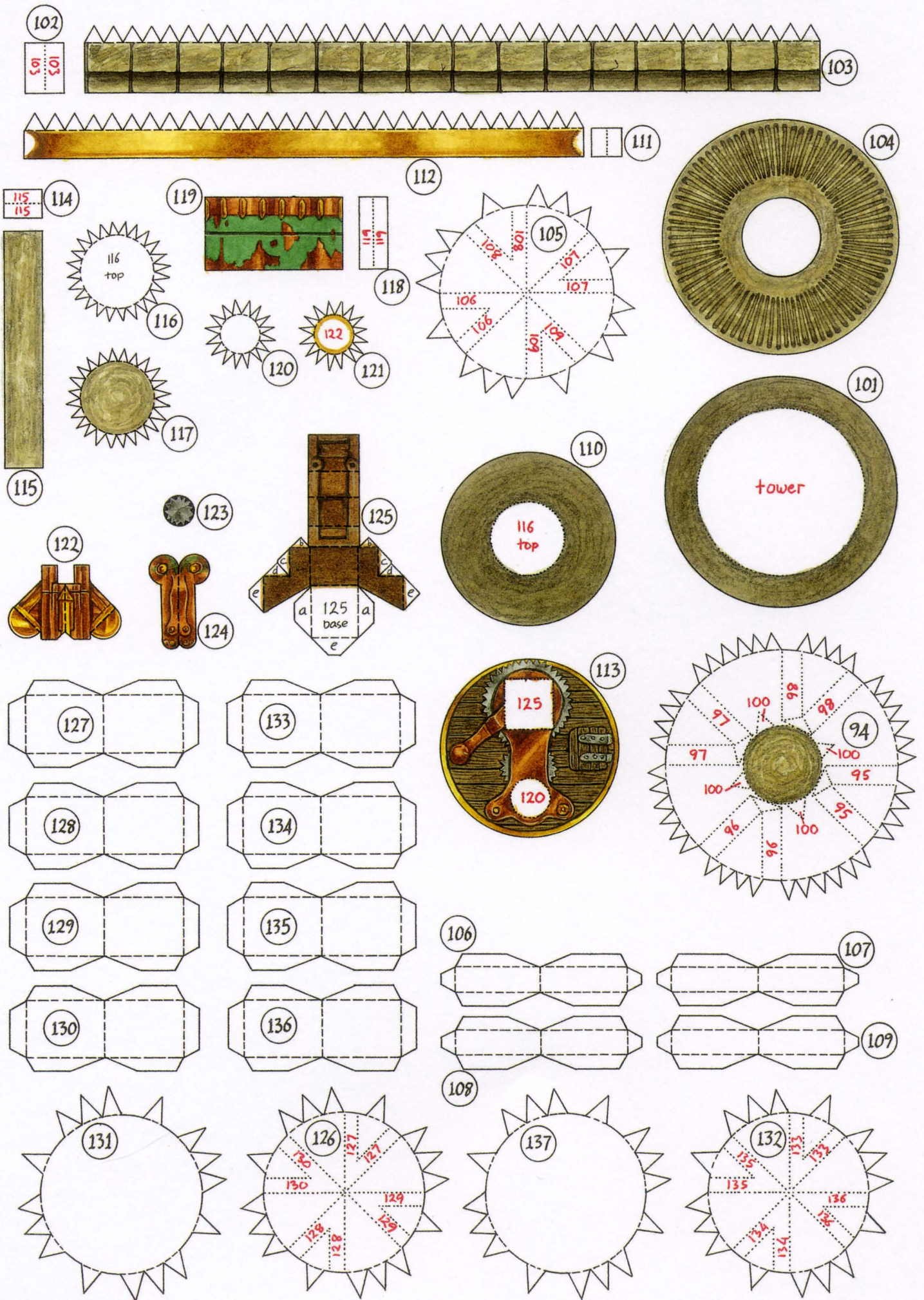

139

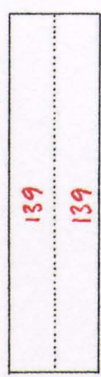

138

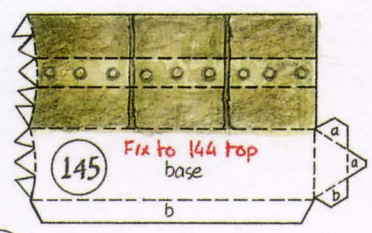
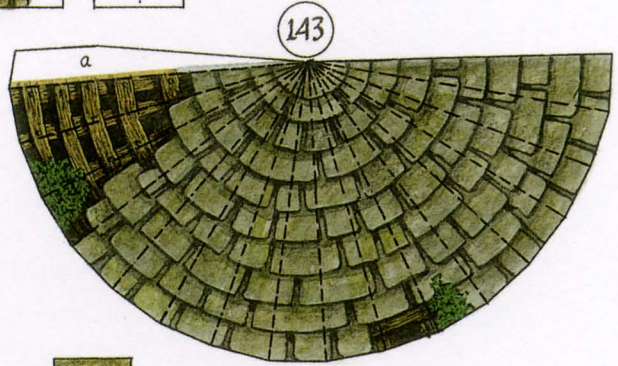
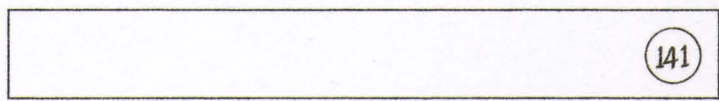
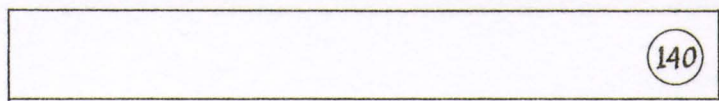
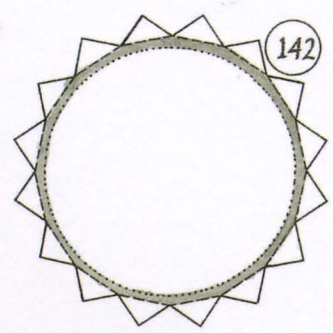

144

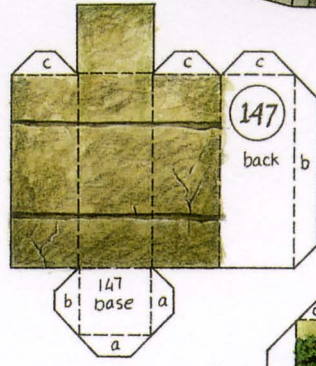
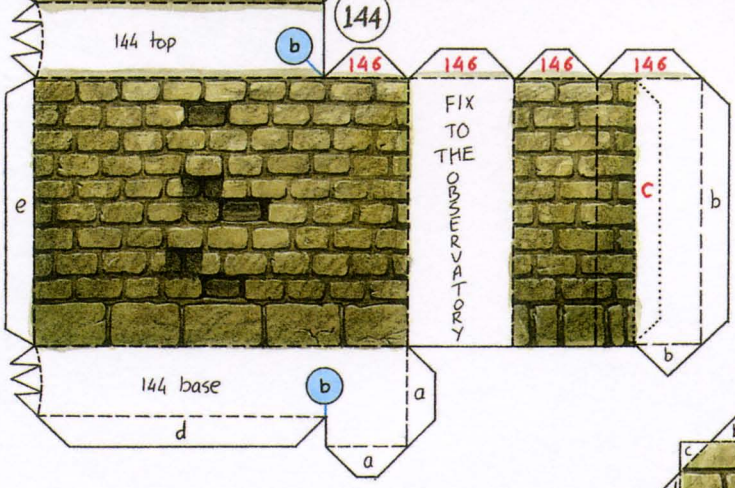

147

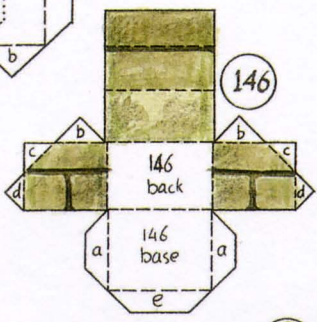

146

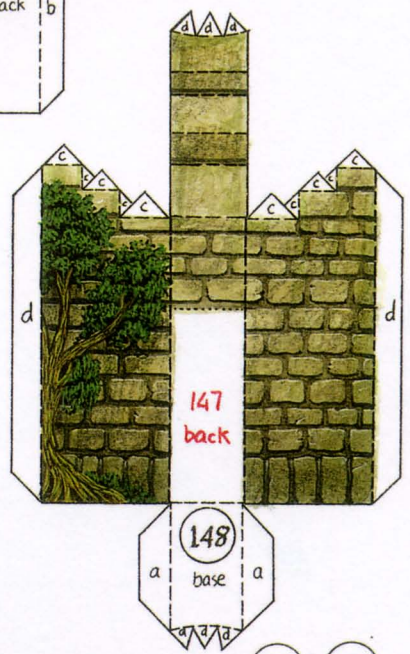

148

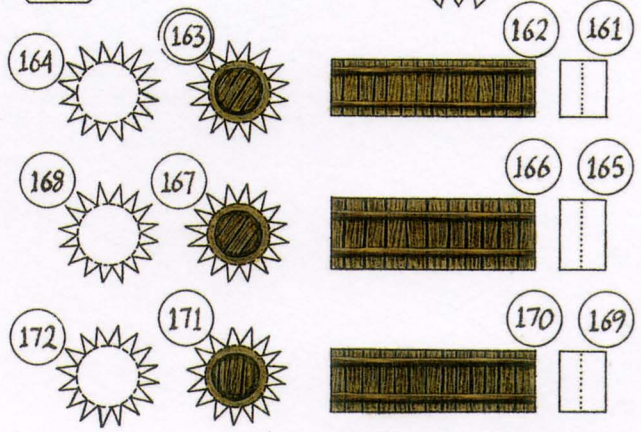
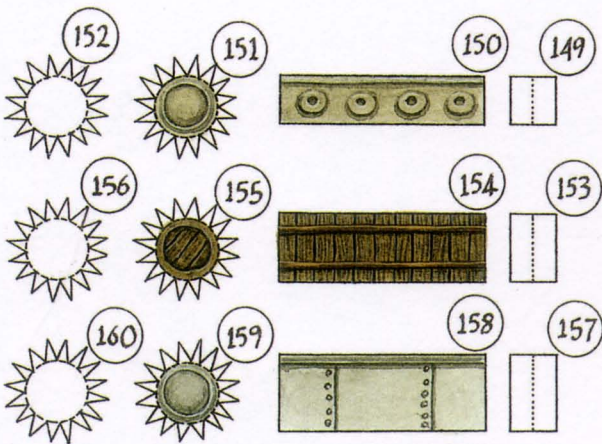

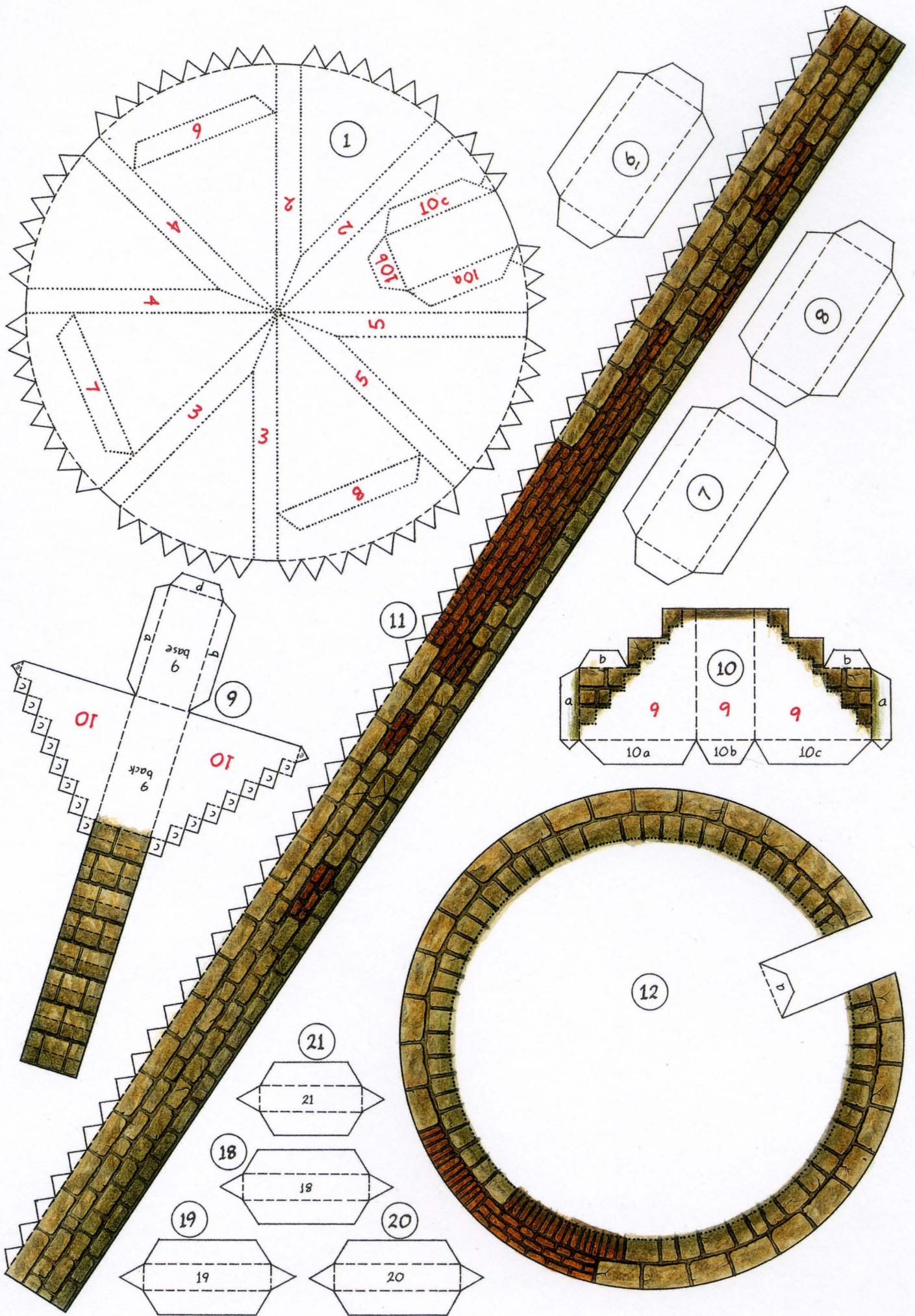

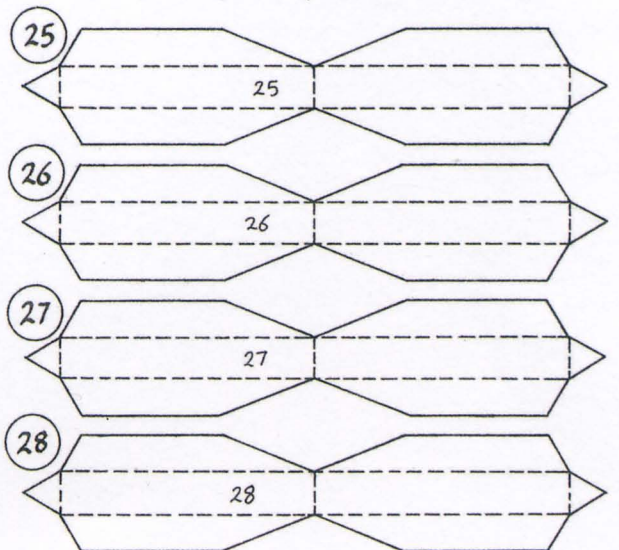
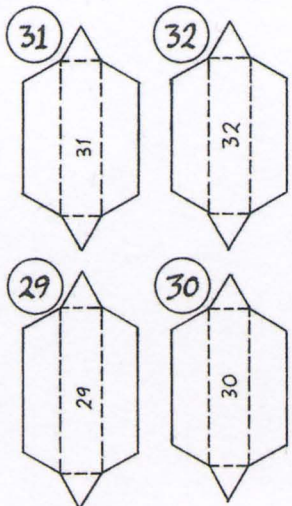
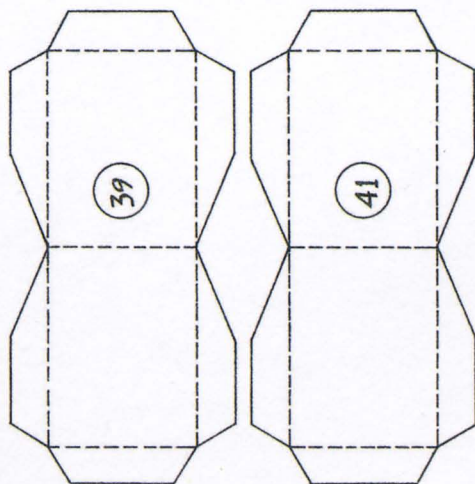
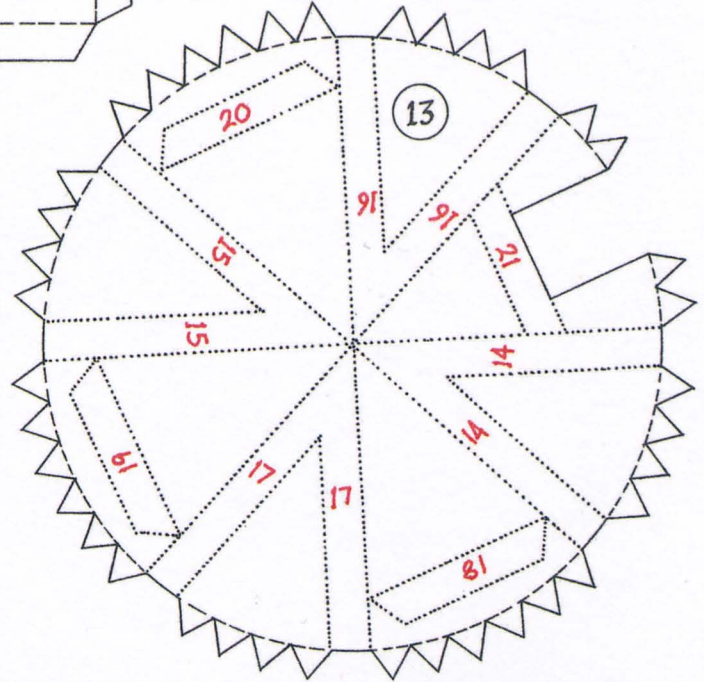
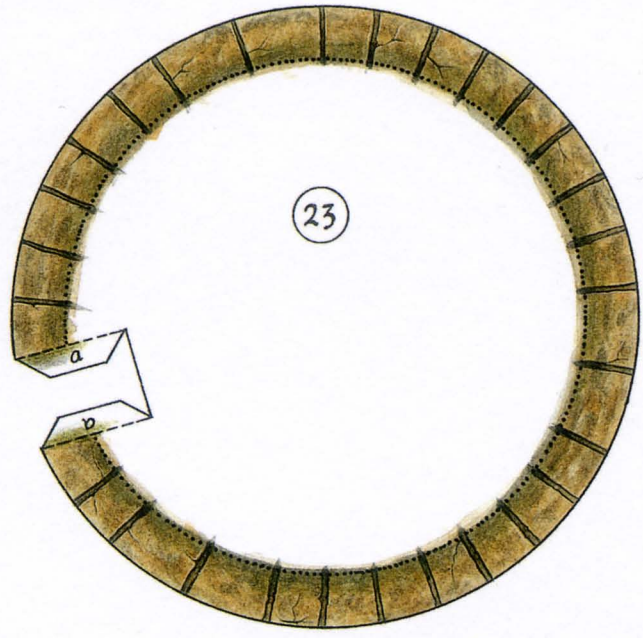
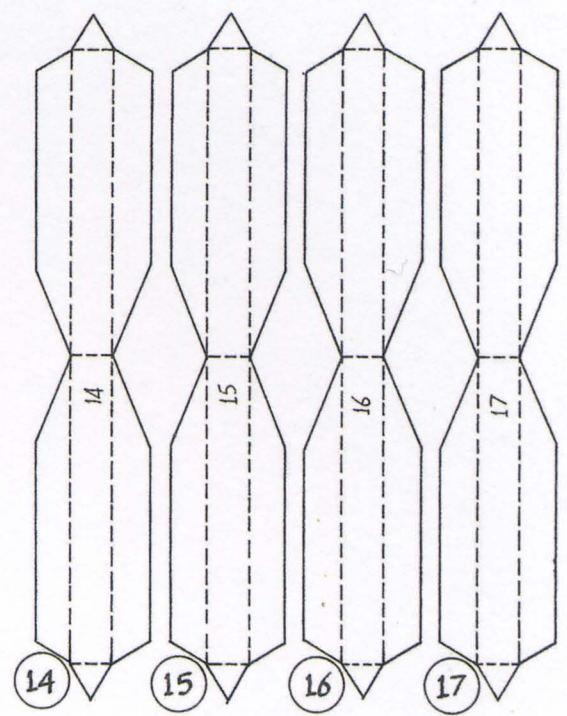
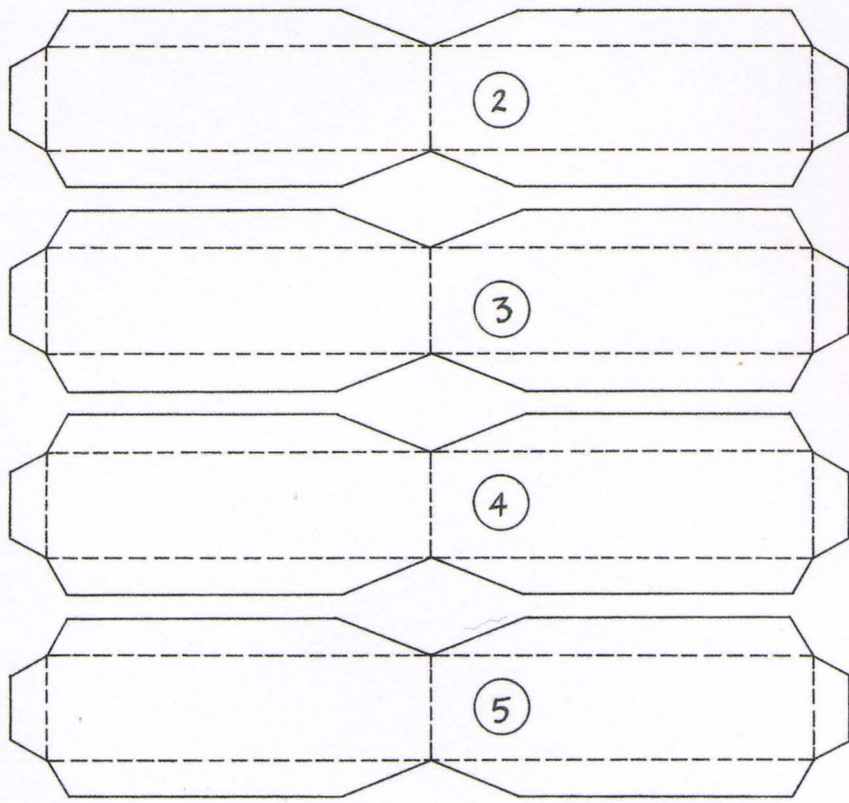

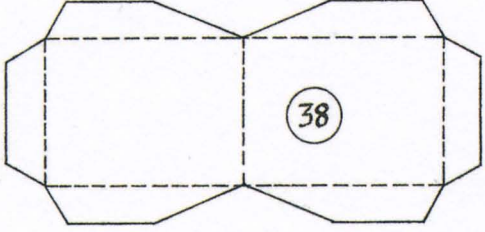
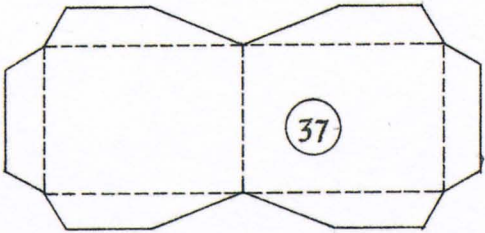
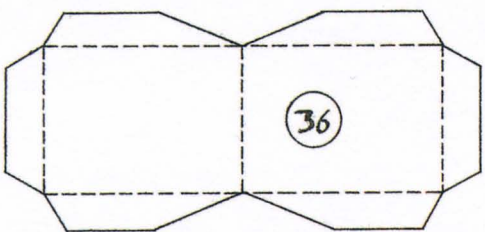
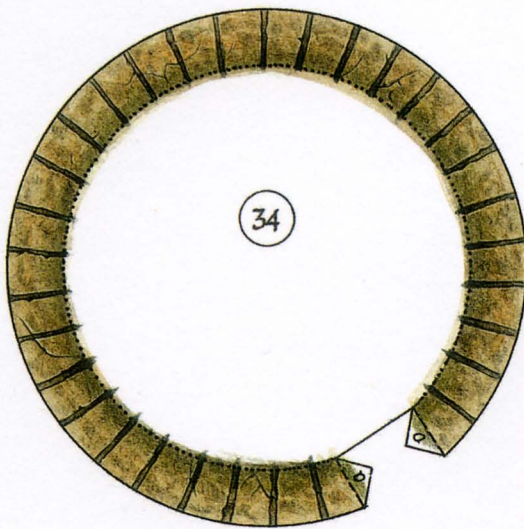
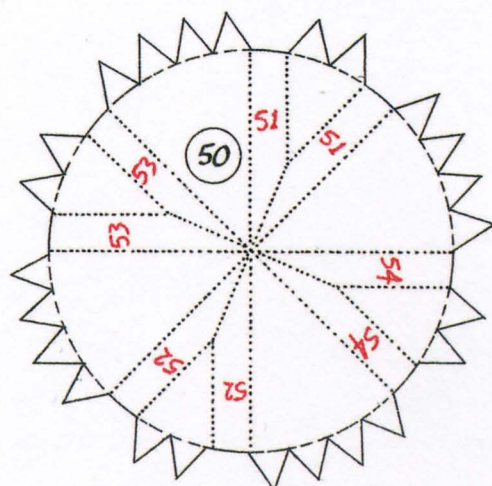
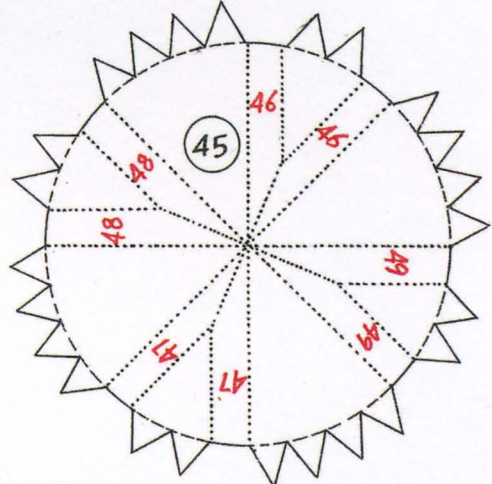
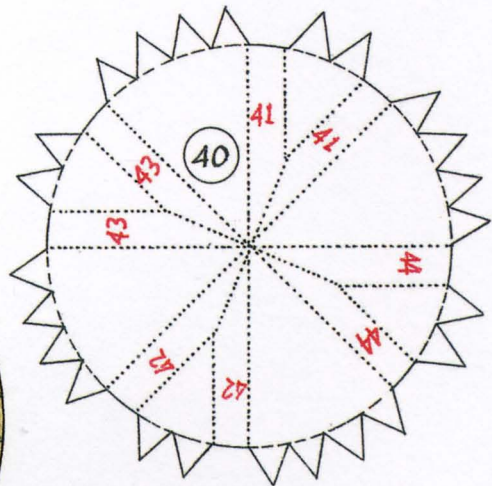
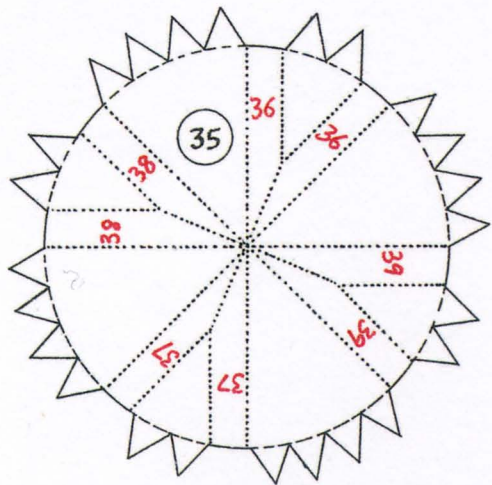
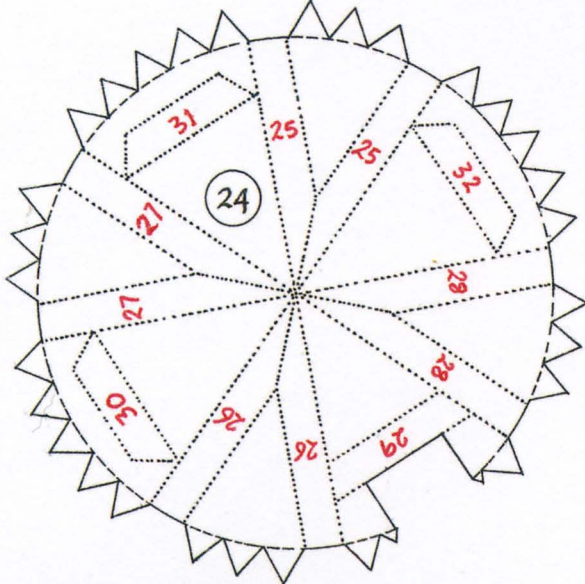

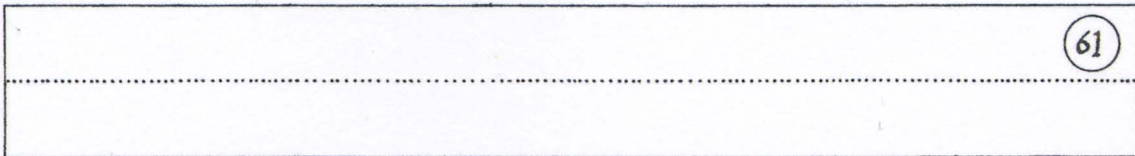
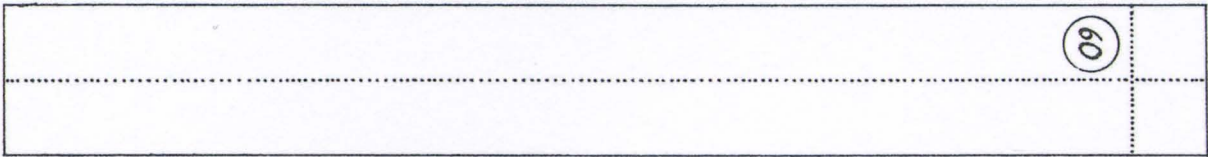
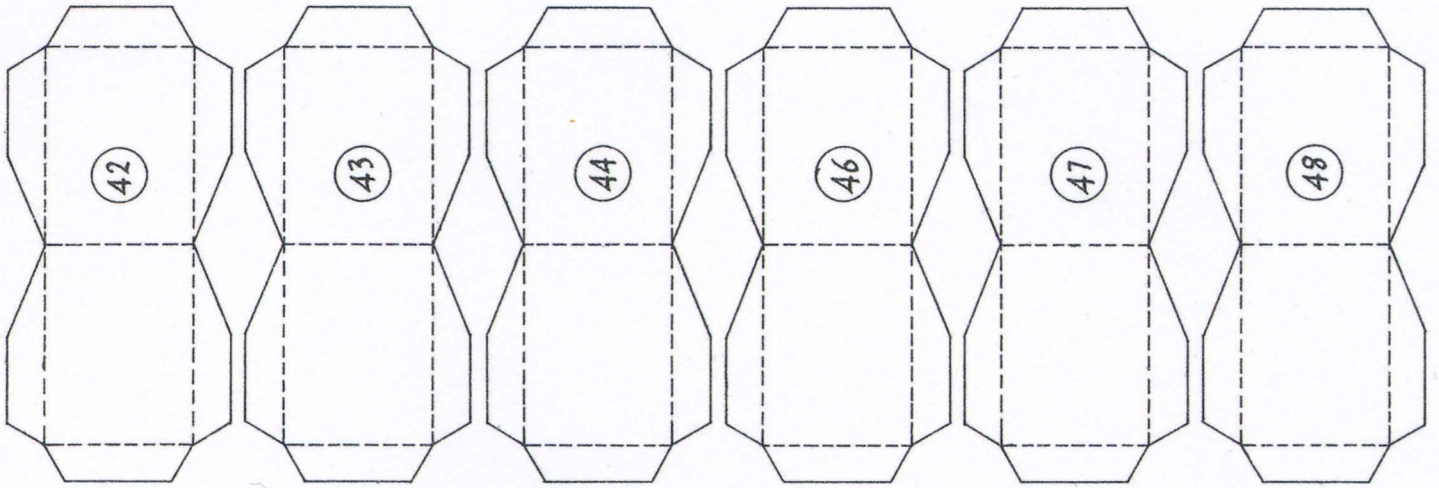

59



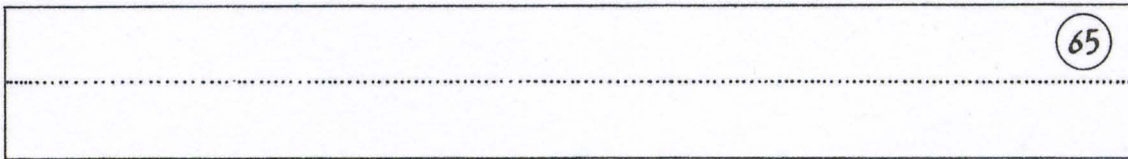
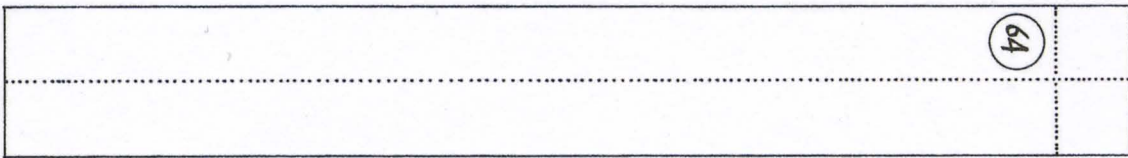
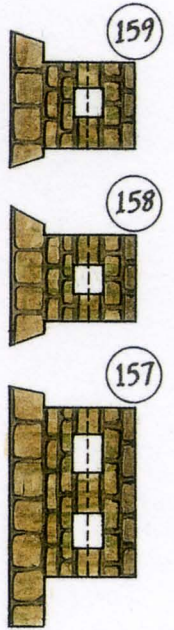
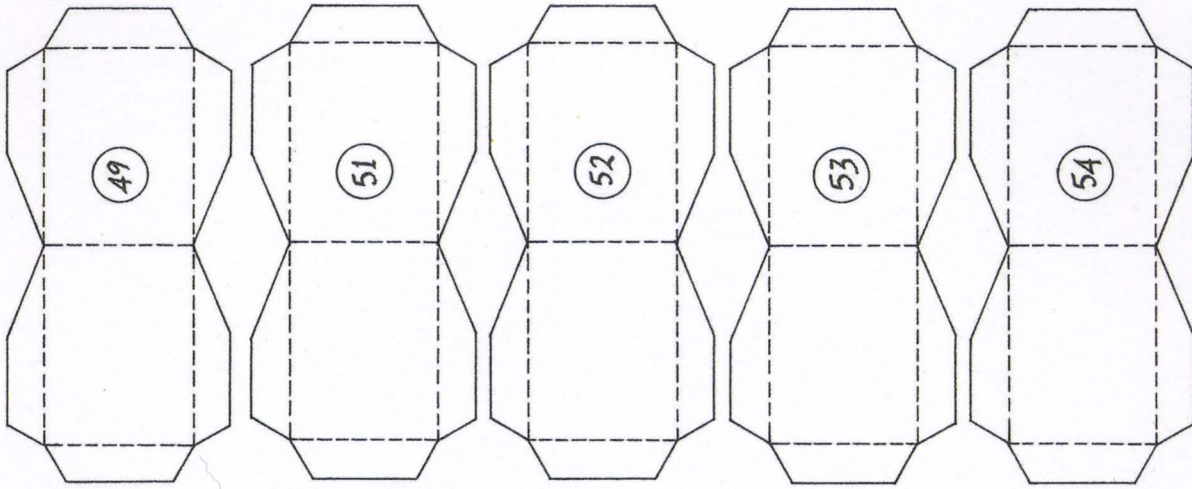

63



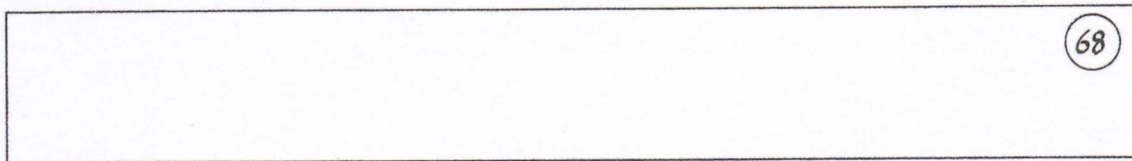
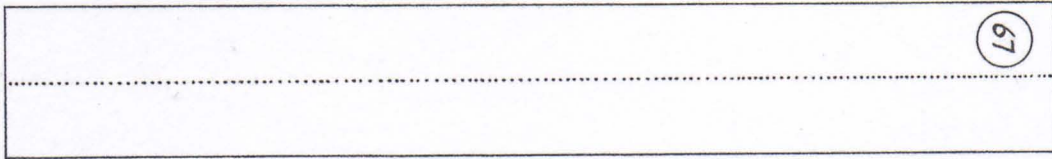
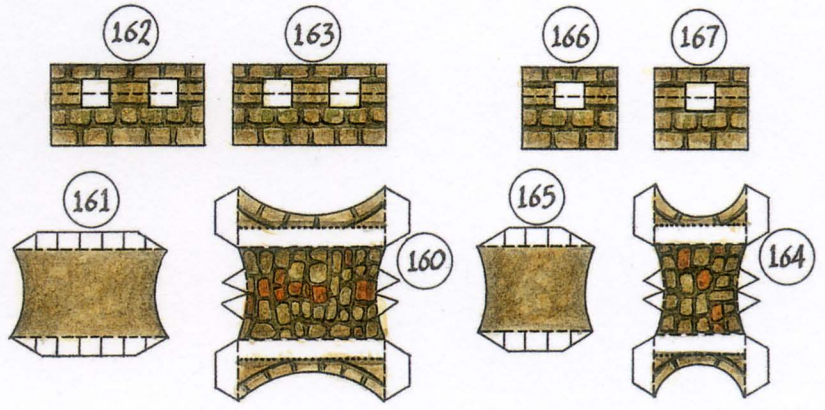
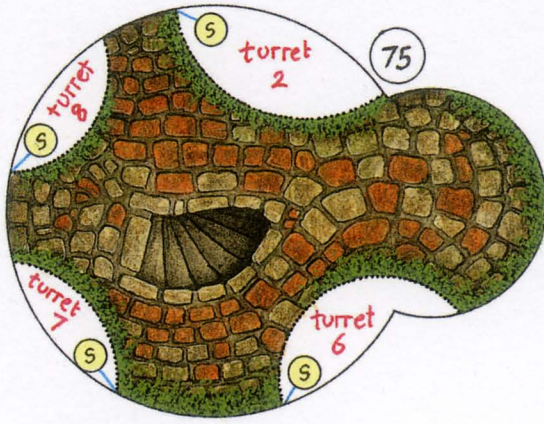

66



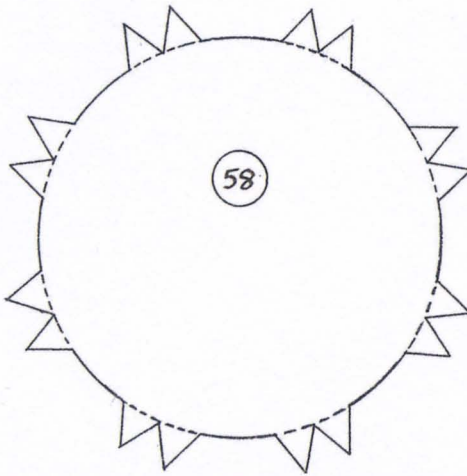
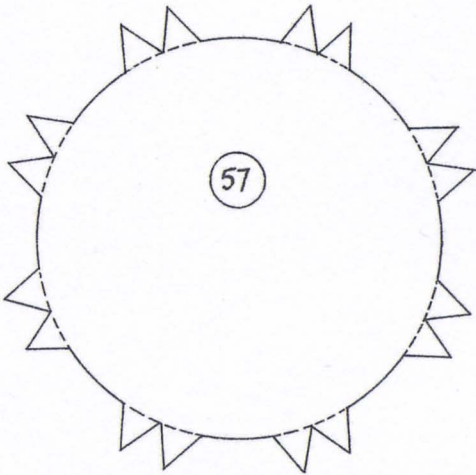
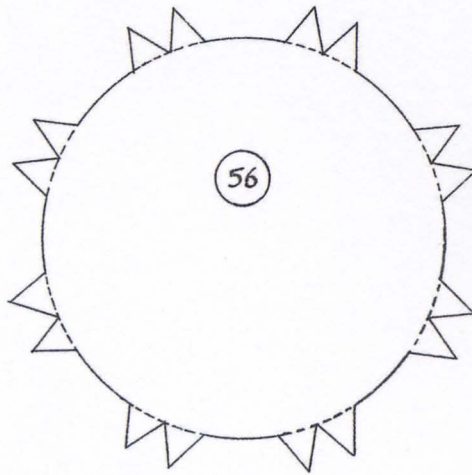
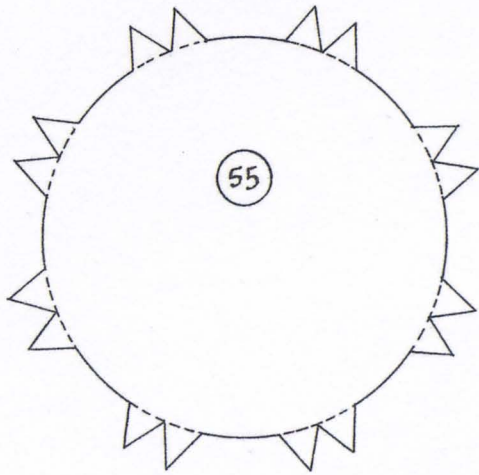

Turret 3

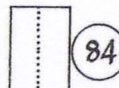
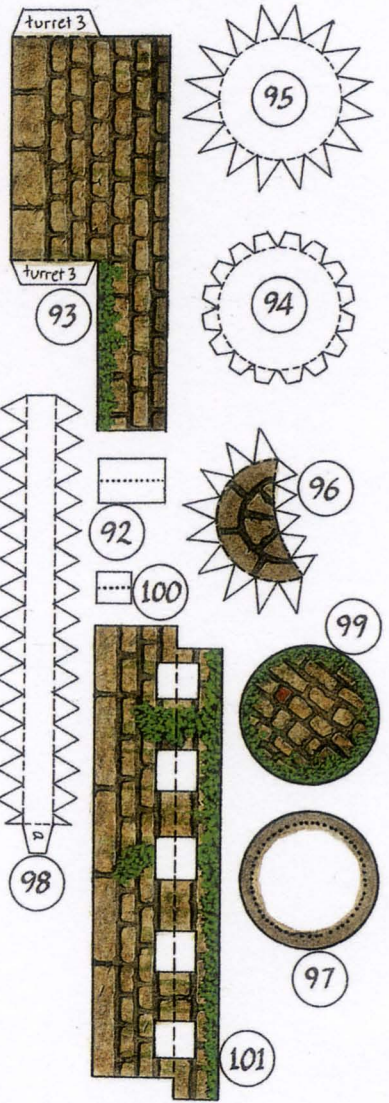

Turret 2

87 88

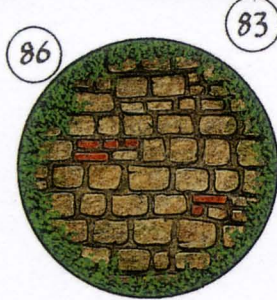

86

83

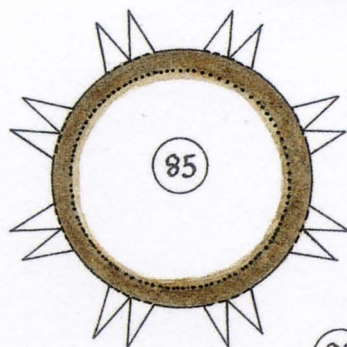
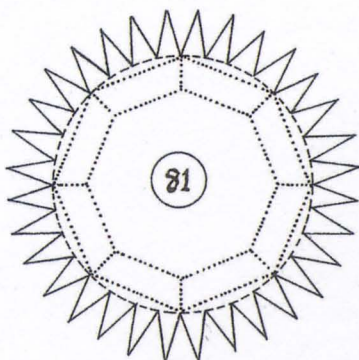

82

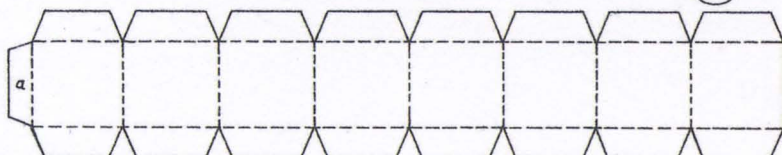

Turret 4

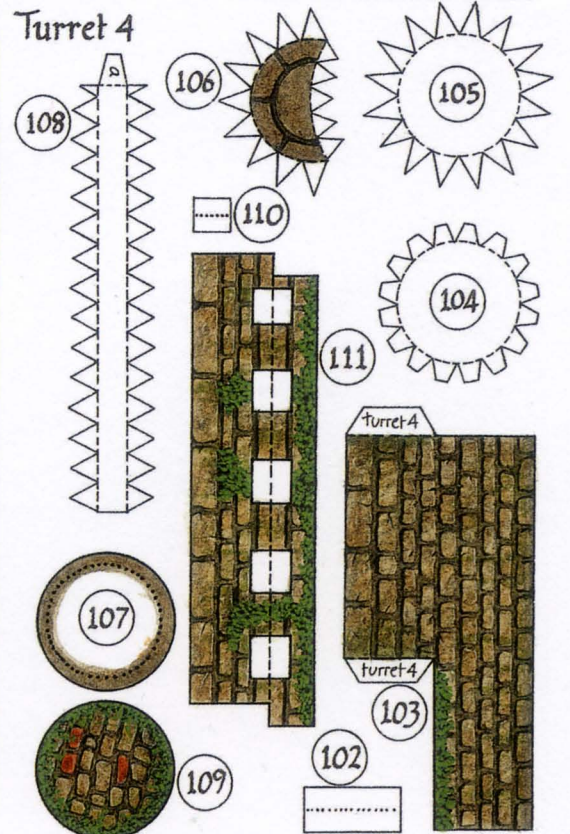

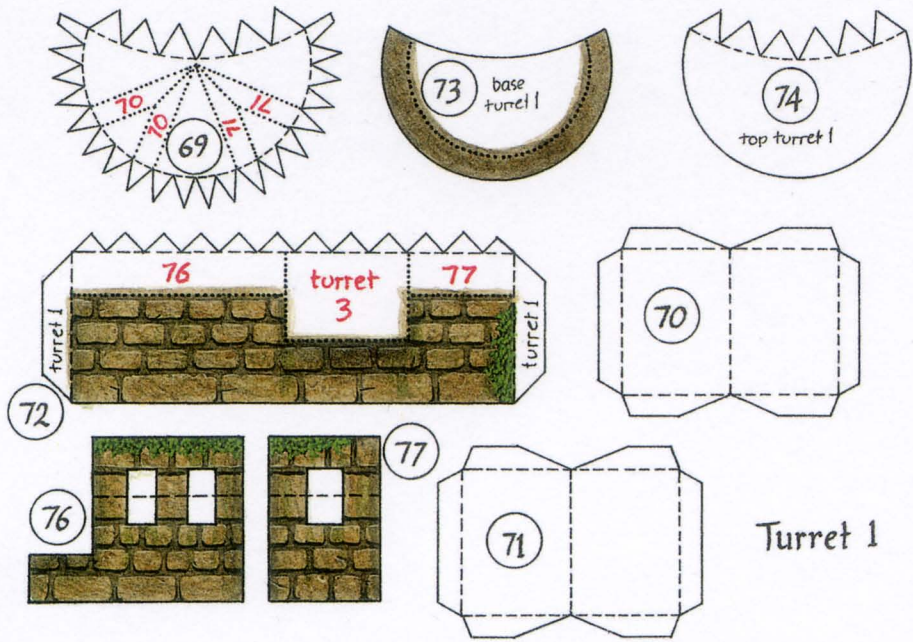

Turret 1

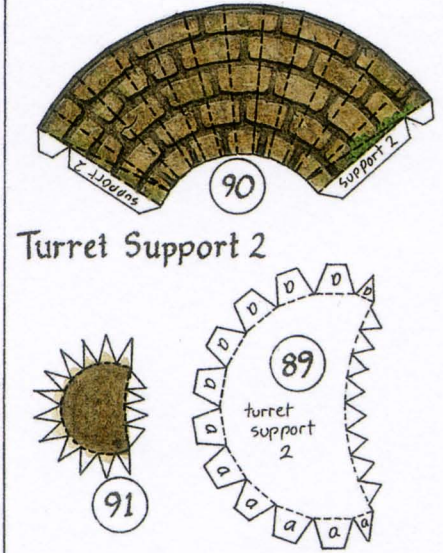

Turret Support 2

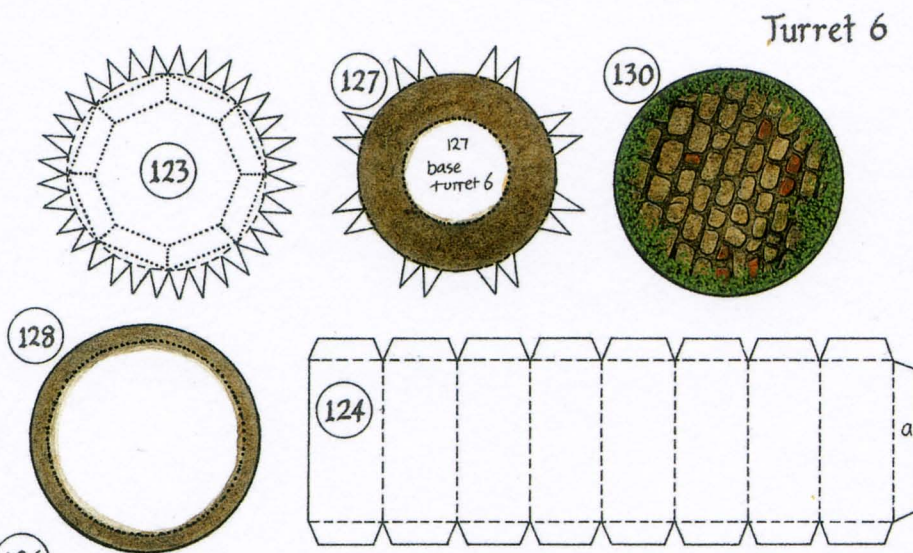

Turret 6

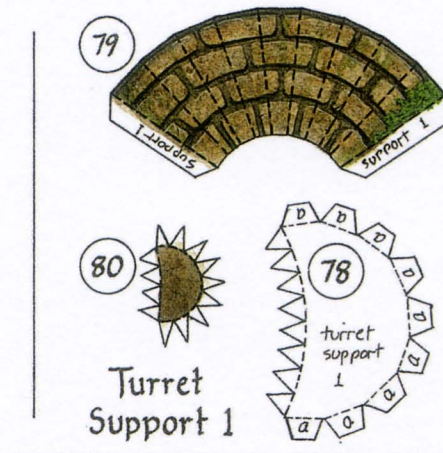

Turret Support 1

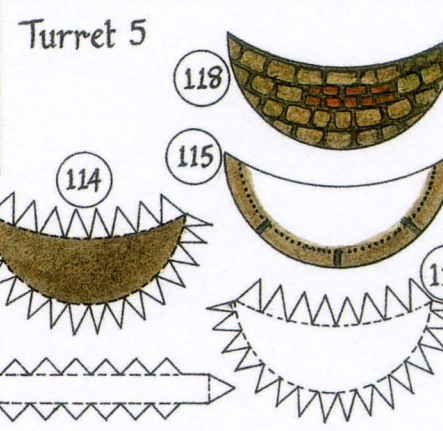
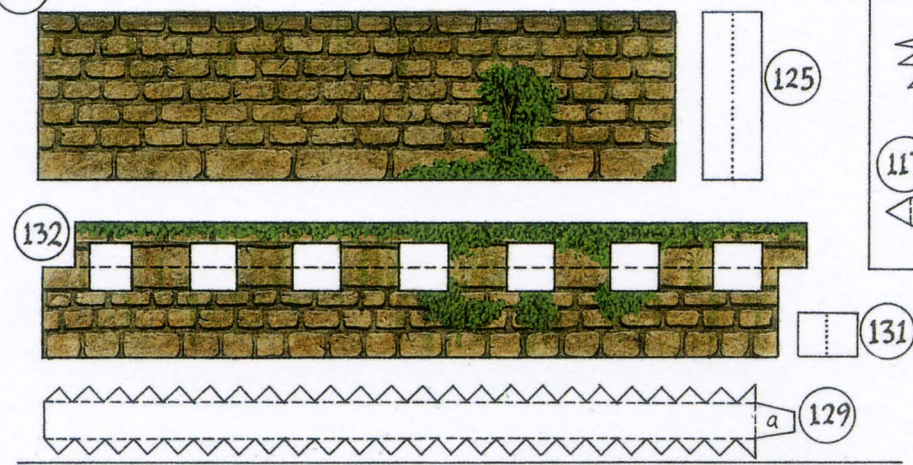

Turret 5

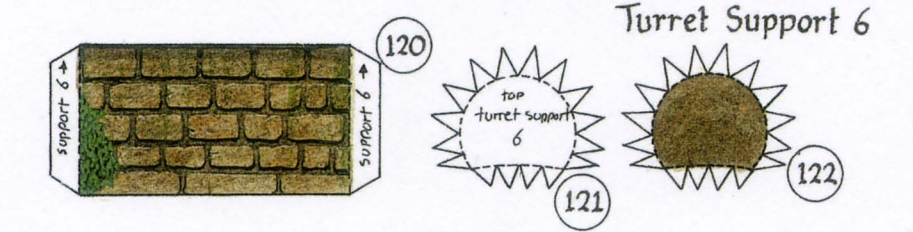

Turret Support 6

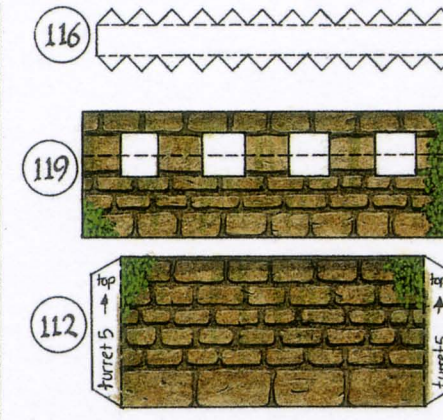

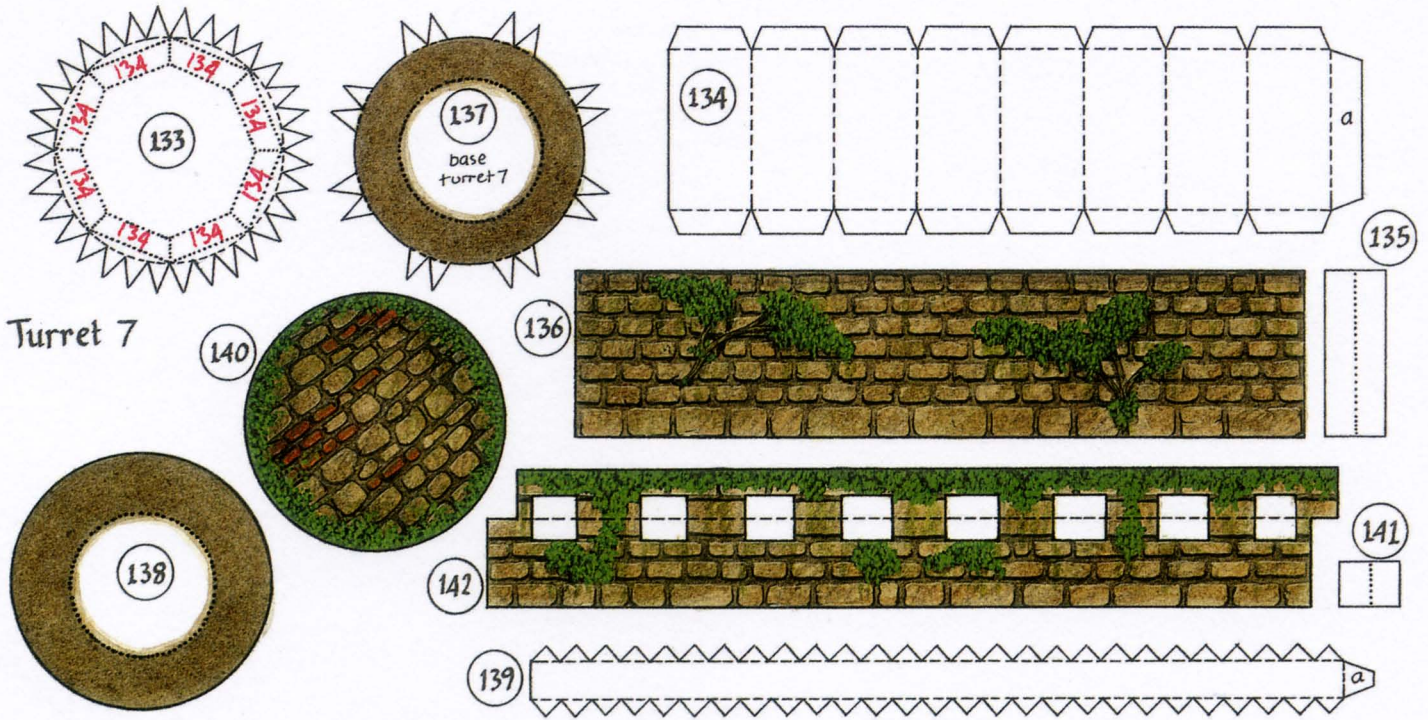

Turret Support 8

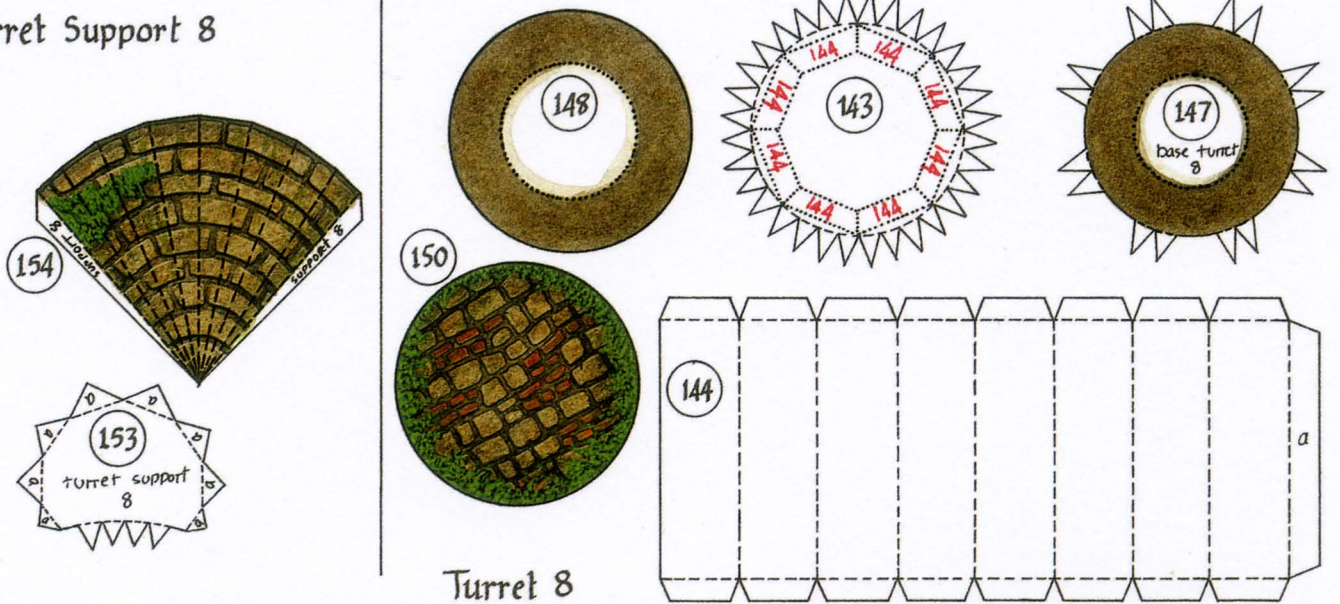

Turret 8

Turret Support 7

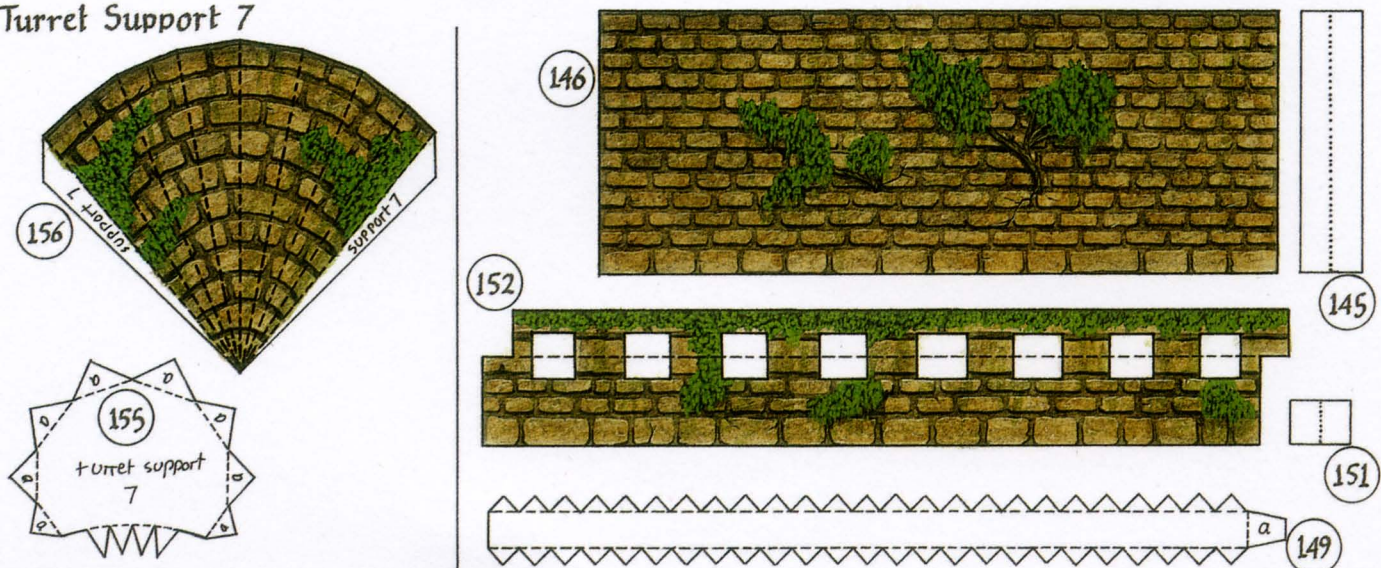

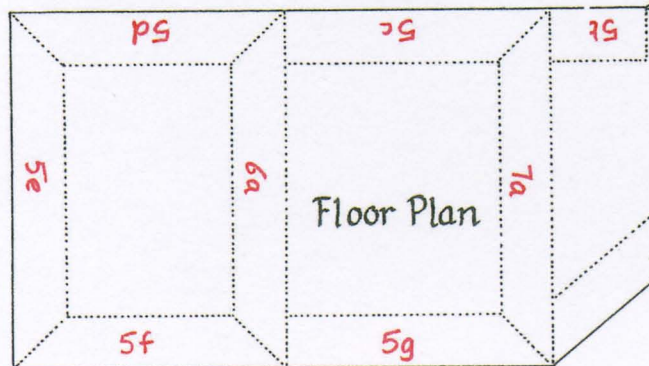
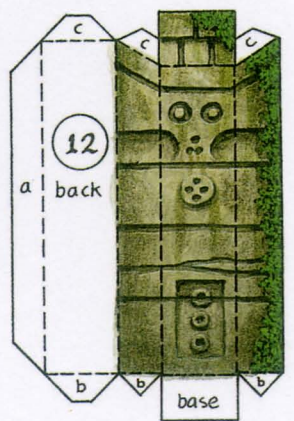
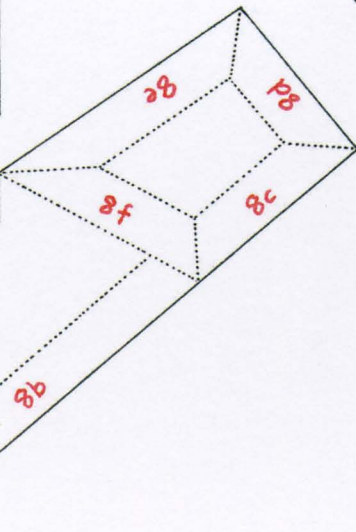
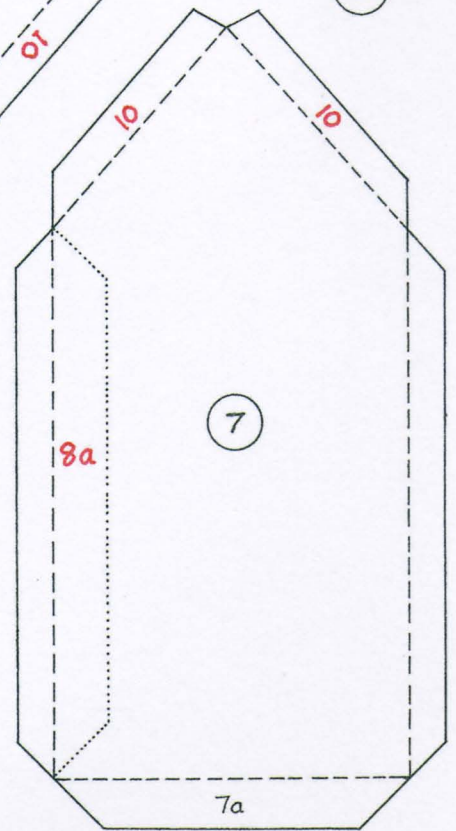
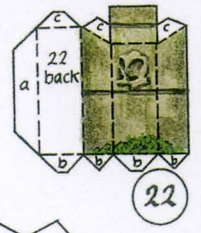
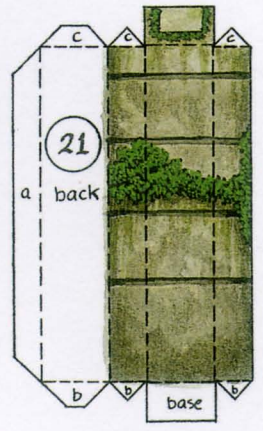
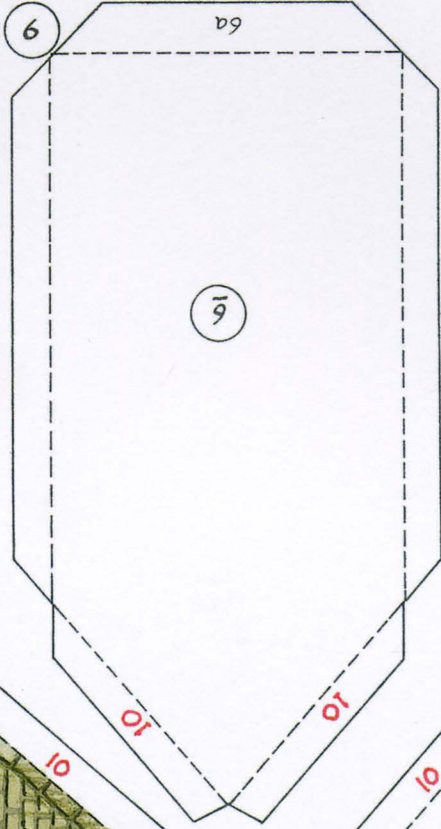
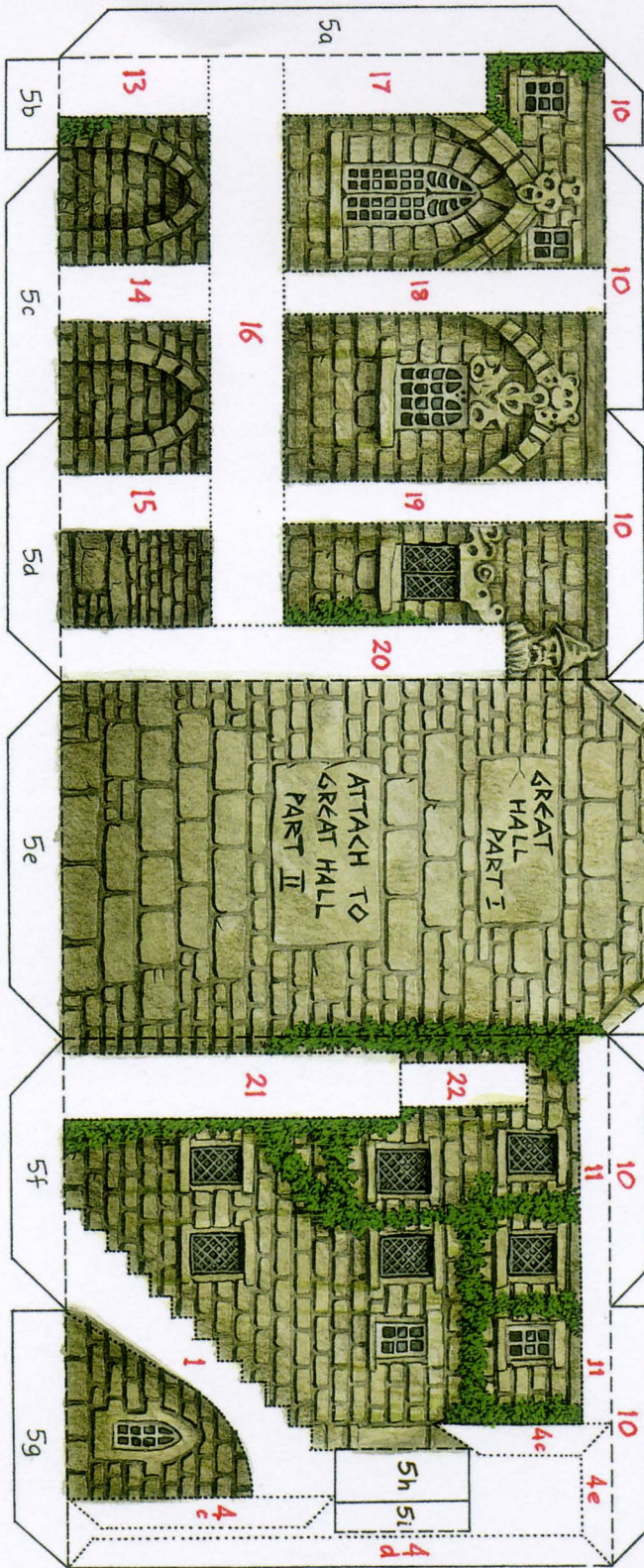

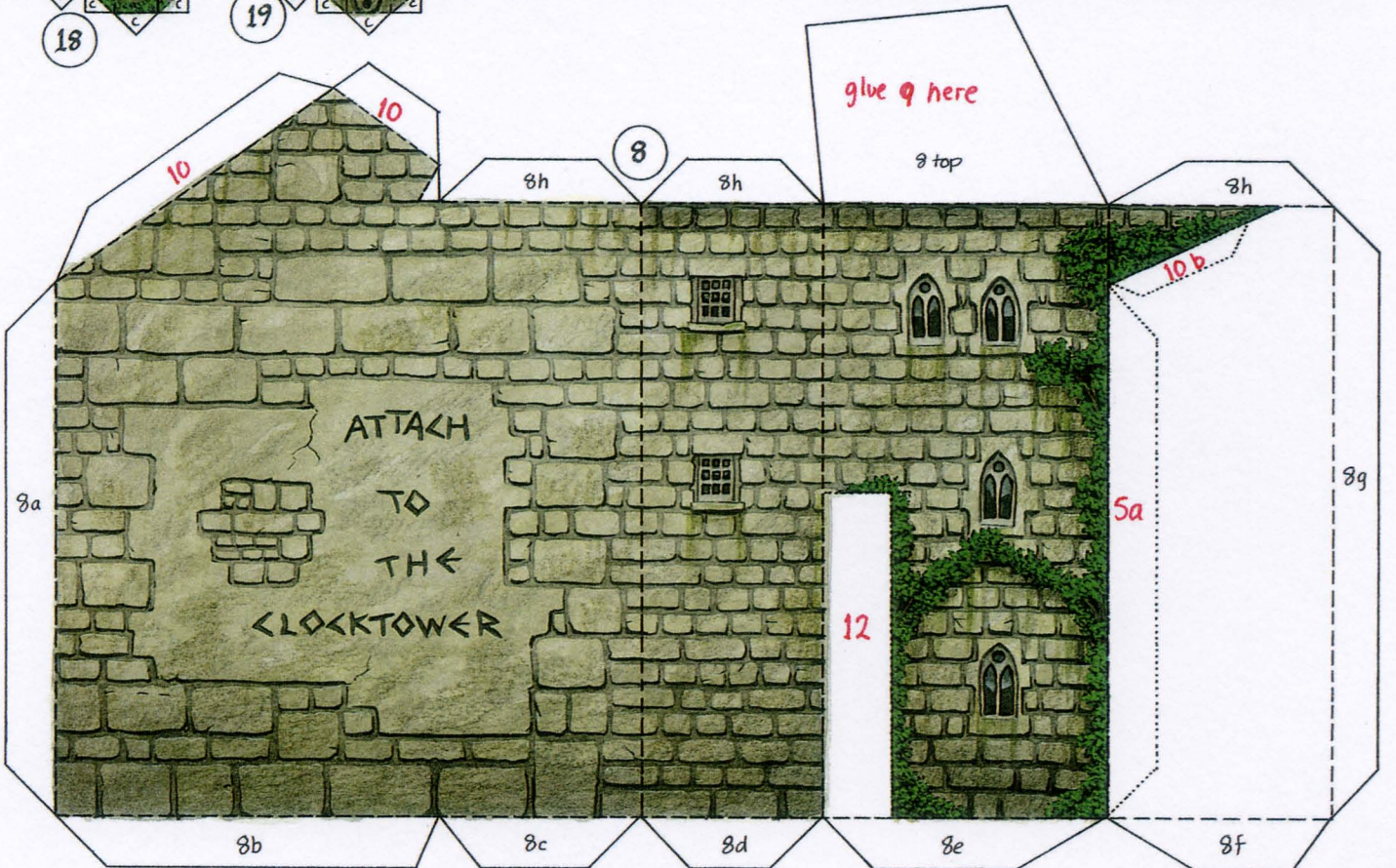
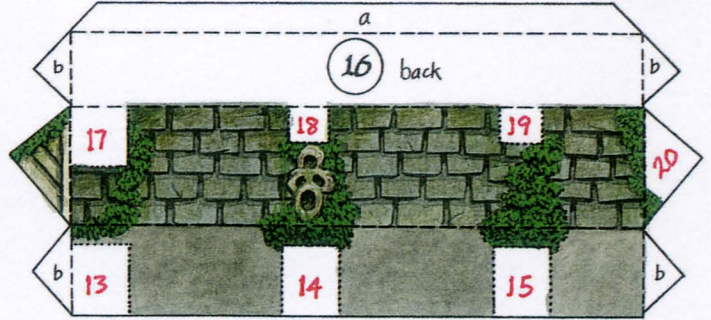
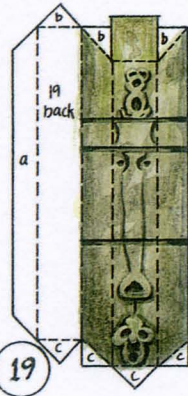
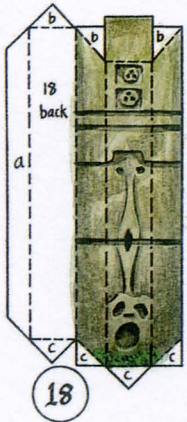
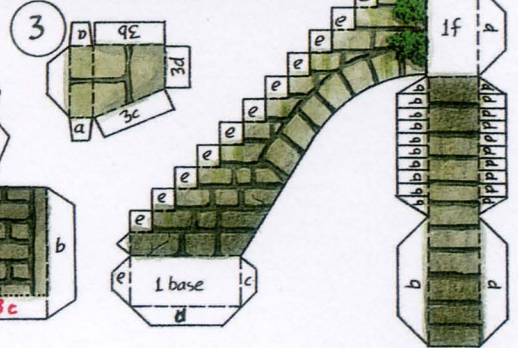
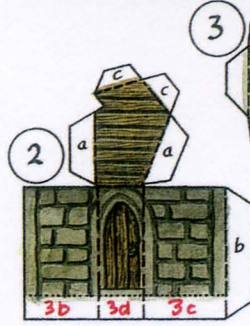
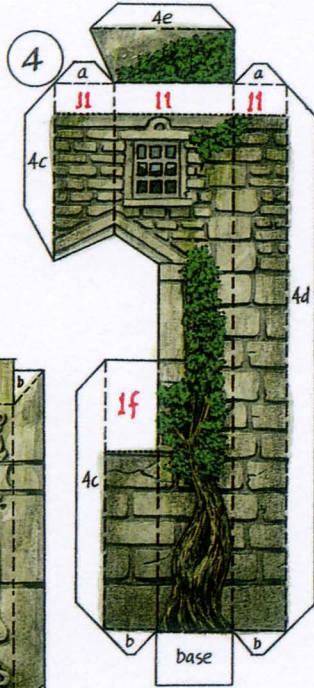
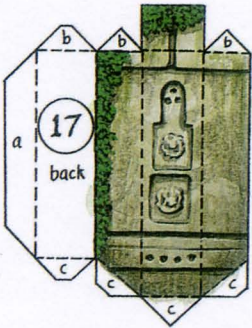
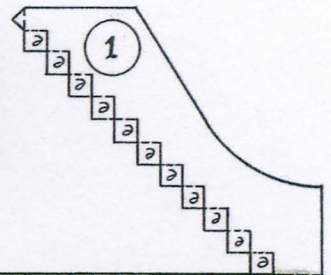
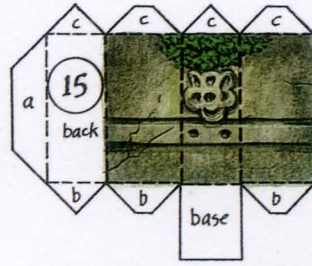
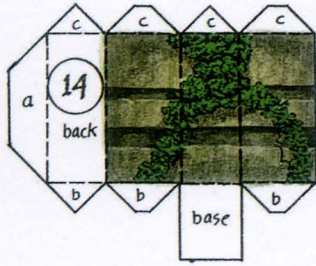
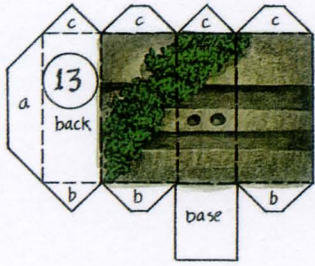

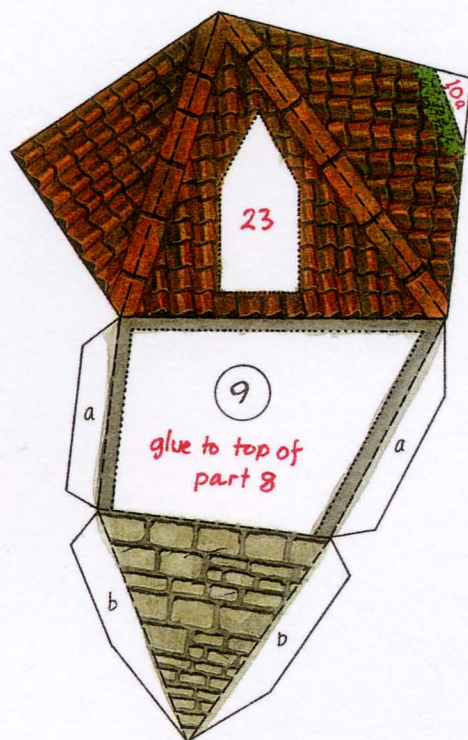
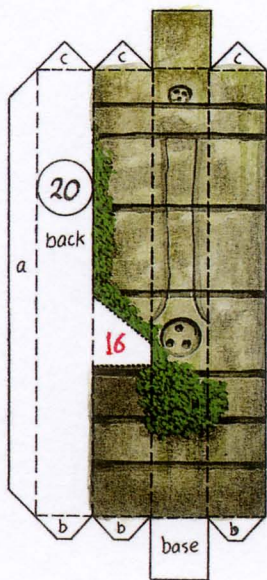
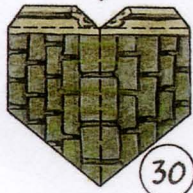
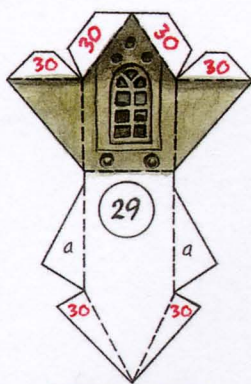
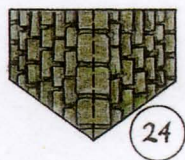
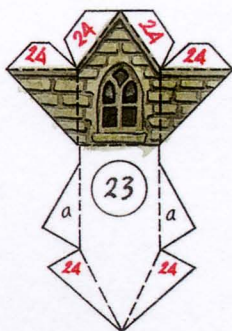
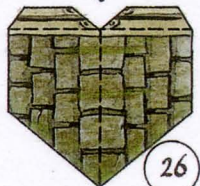
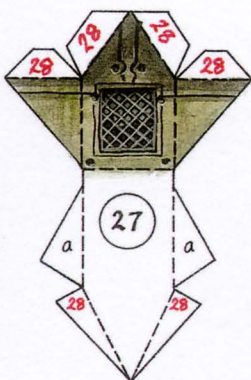
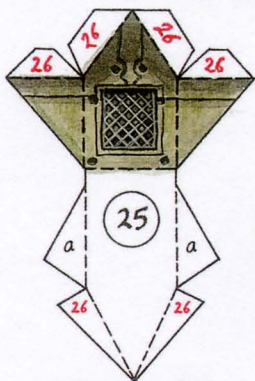
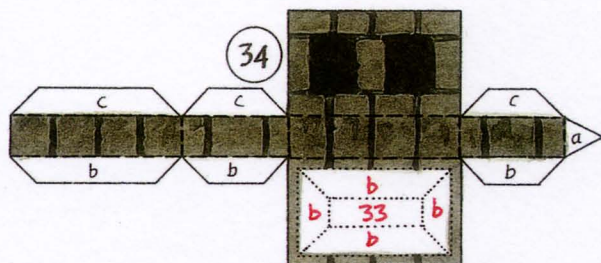
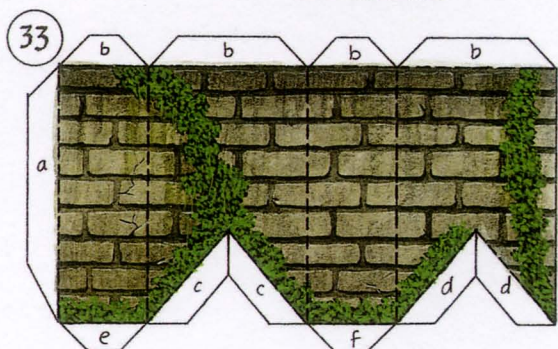
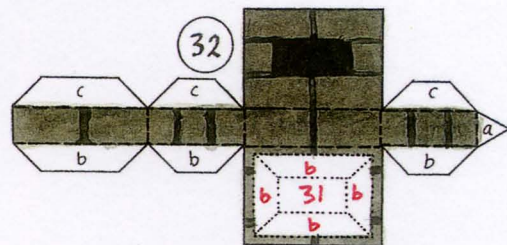
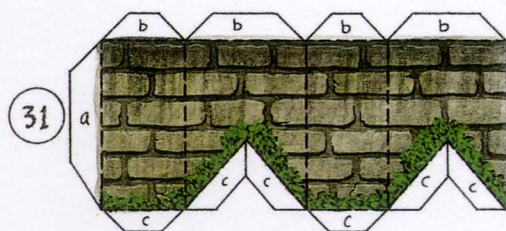
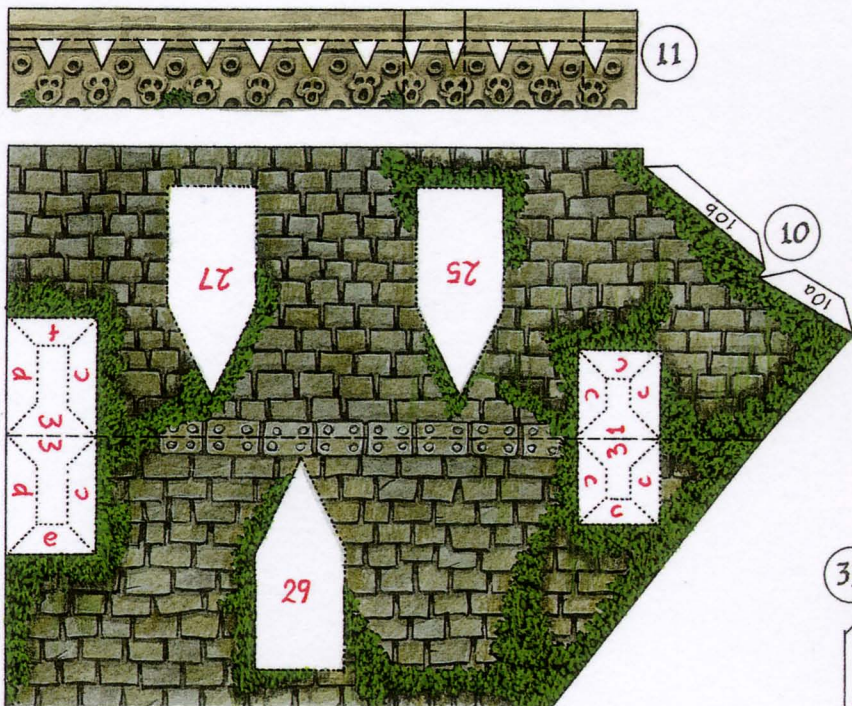

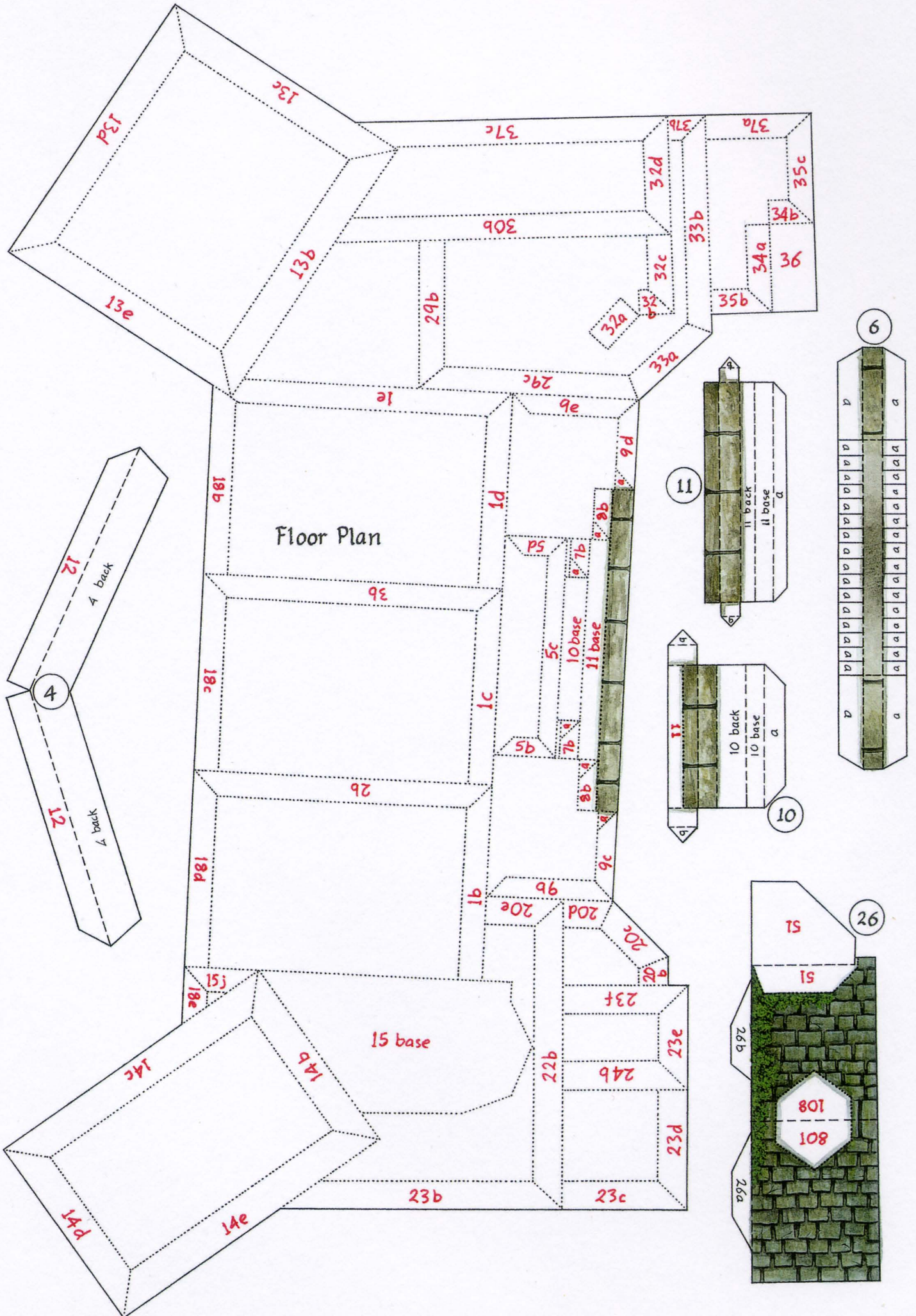

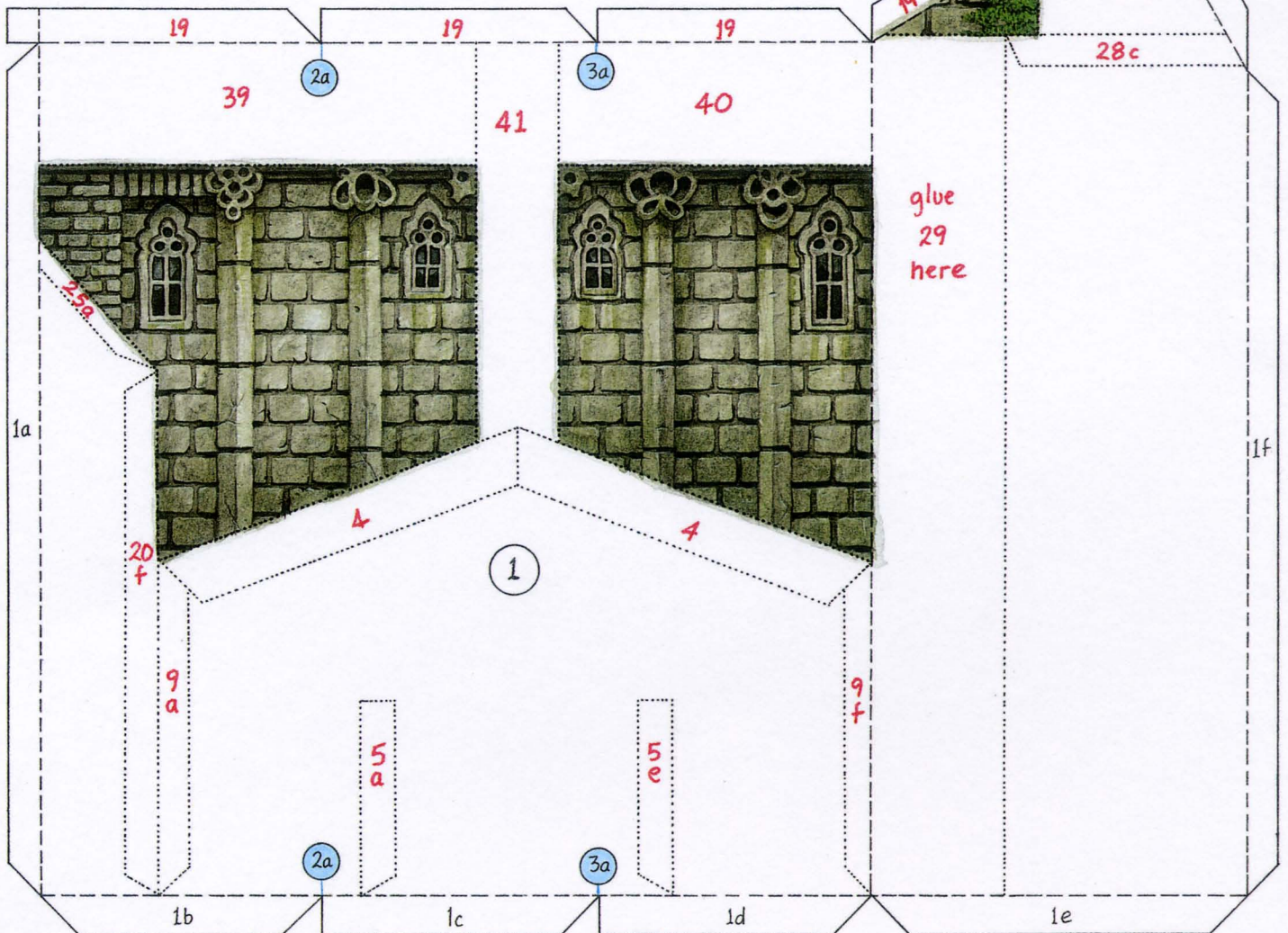
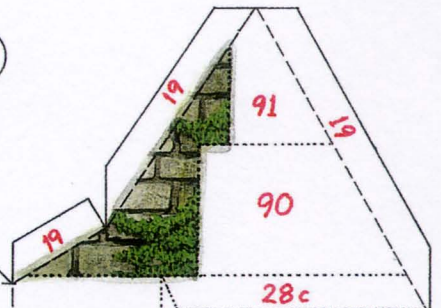
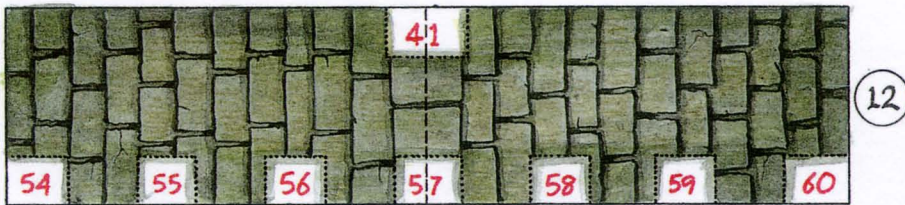
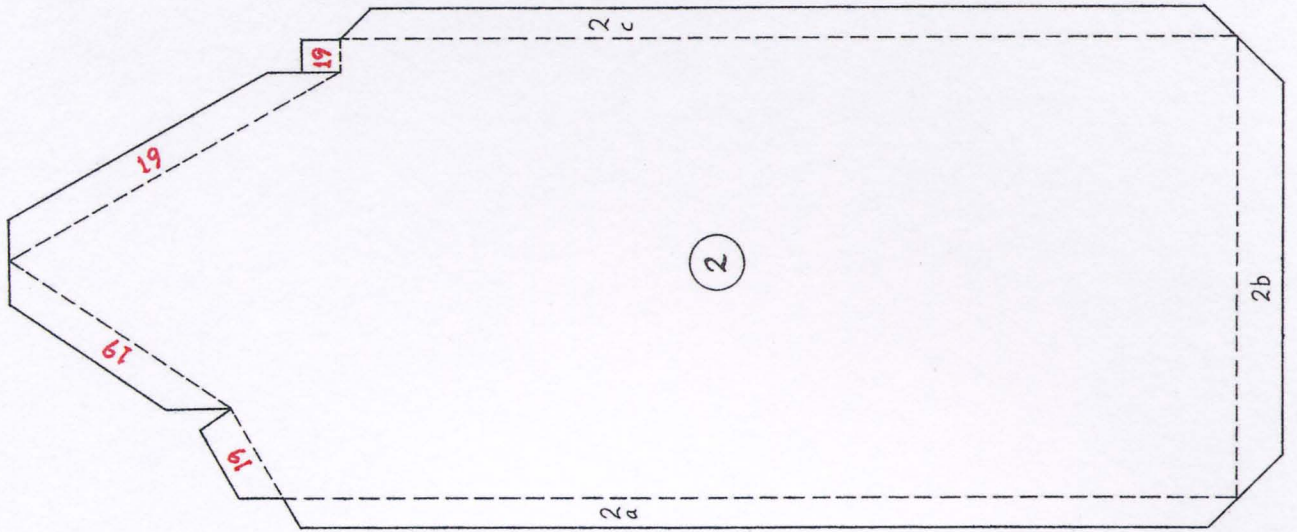

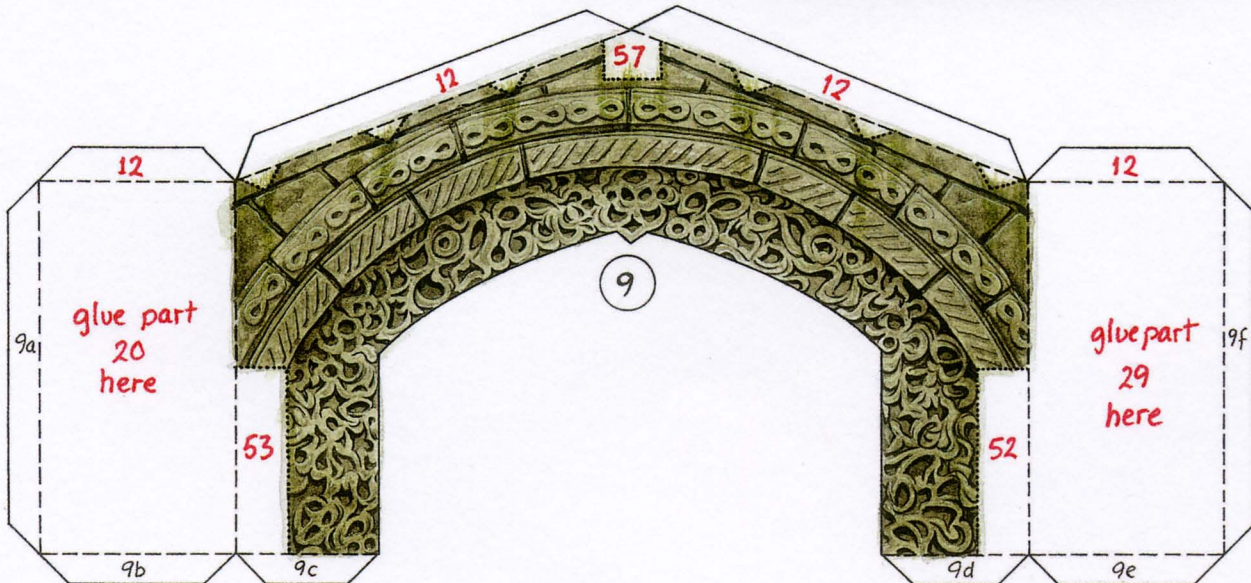
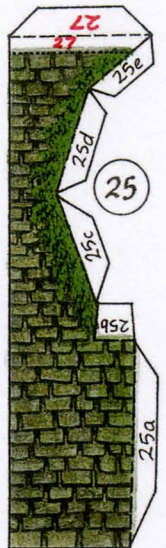
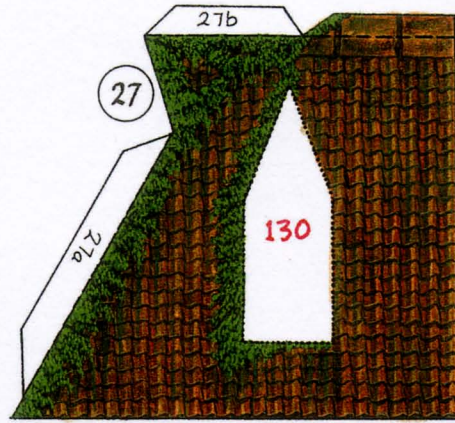
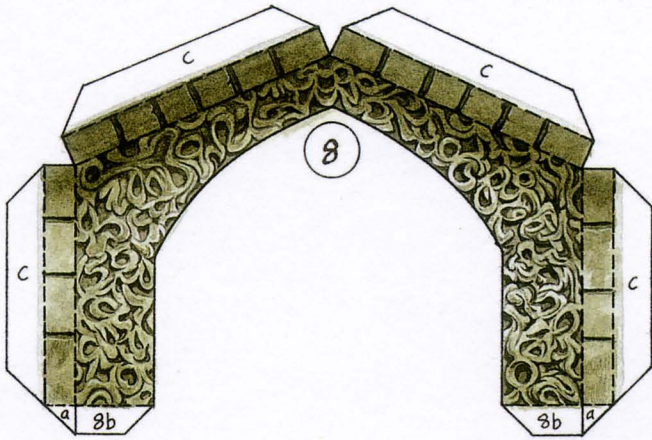
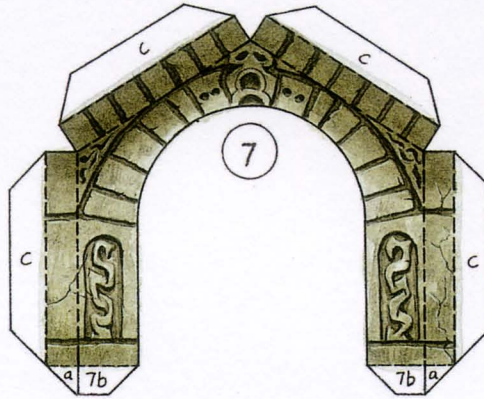
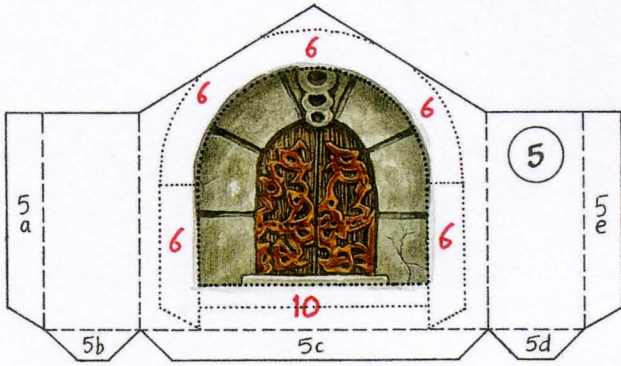
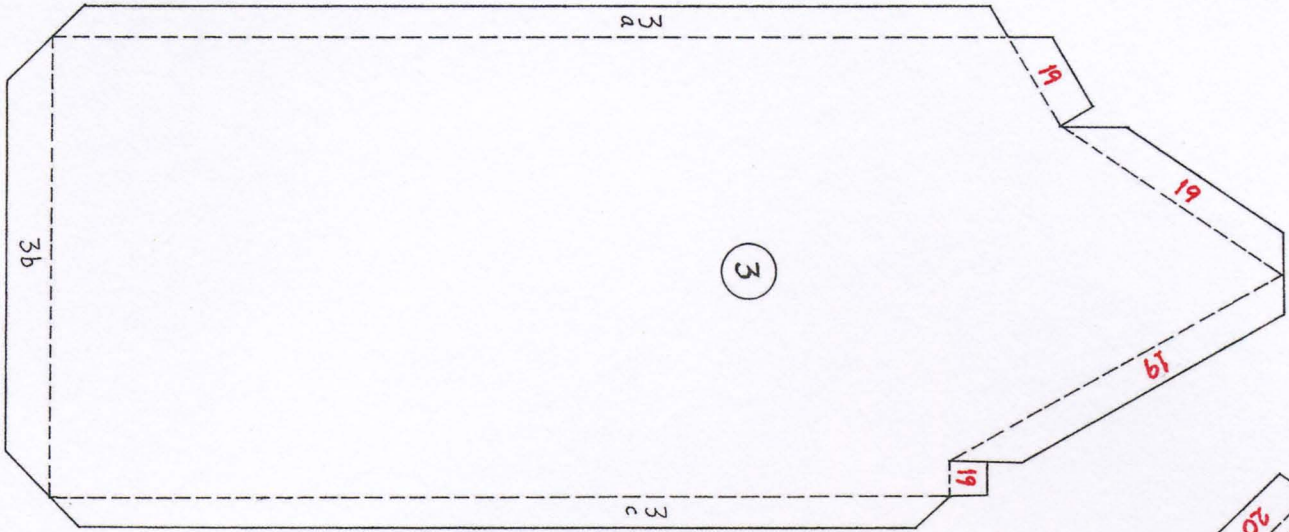

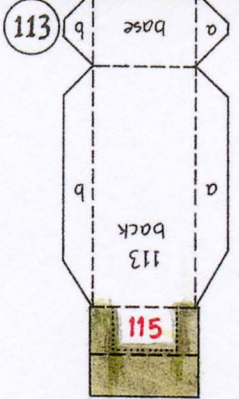
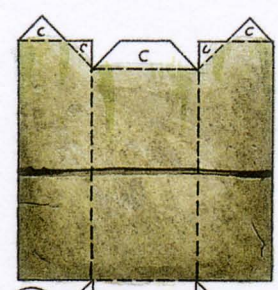
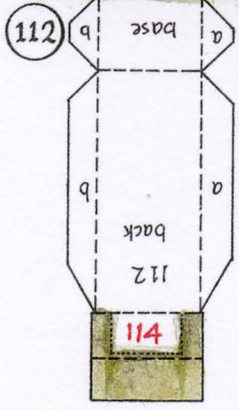
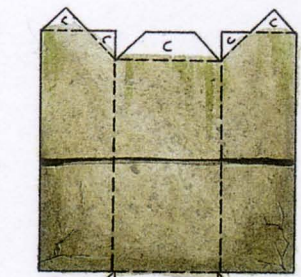

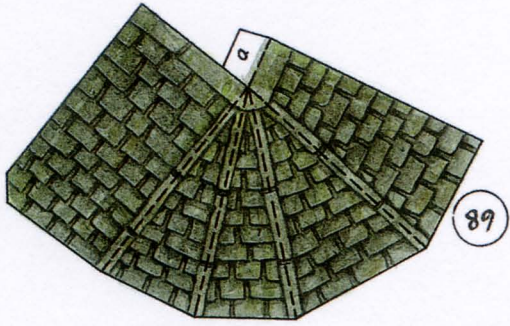

89

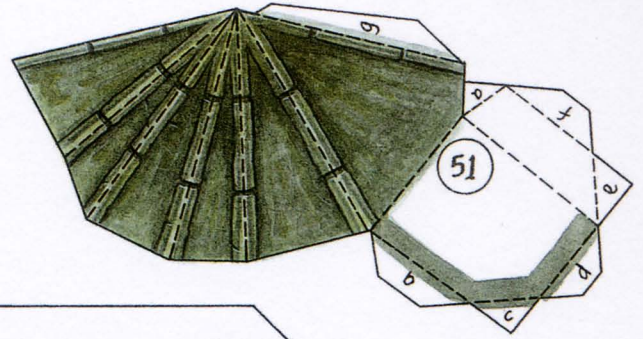

51

14

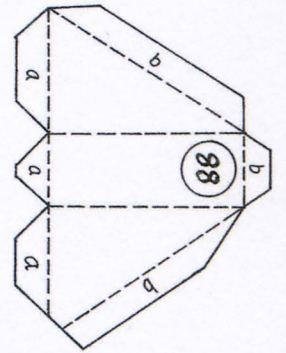

88

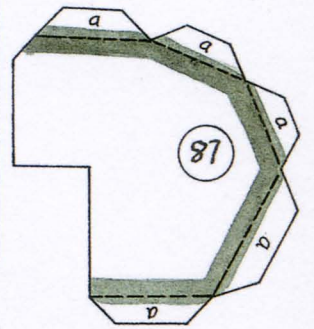

87

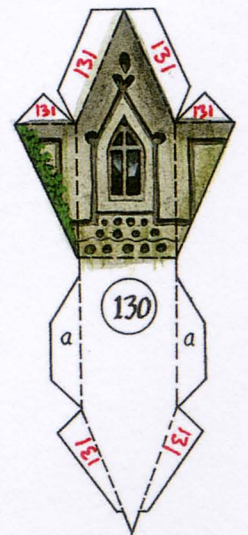

130

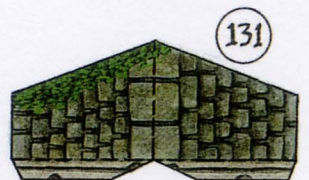

131

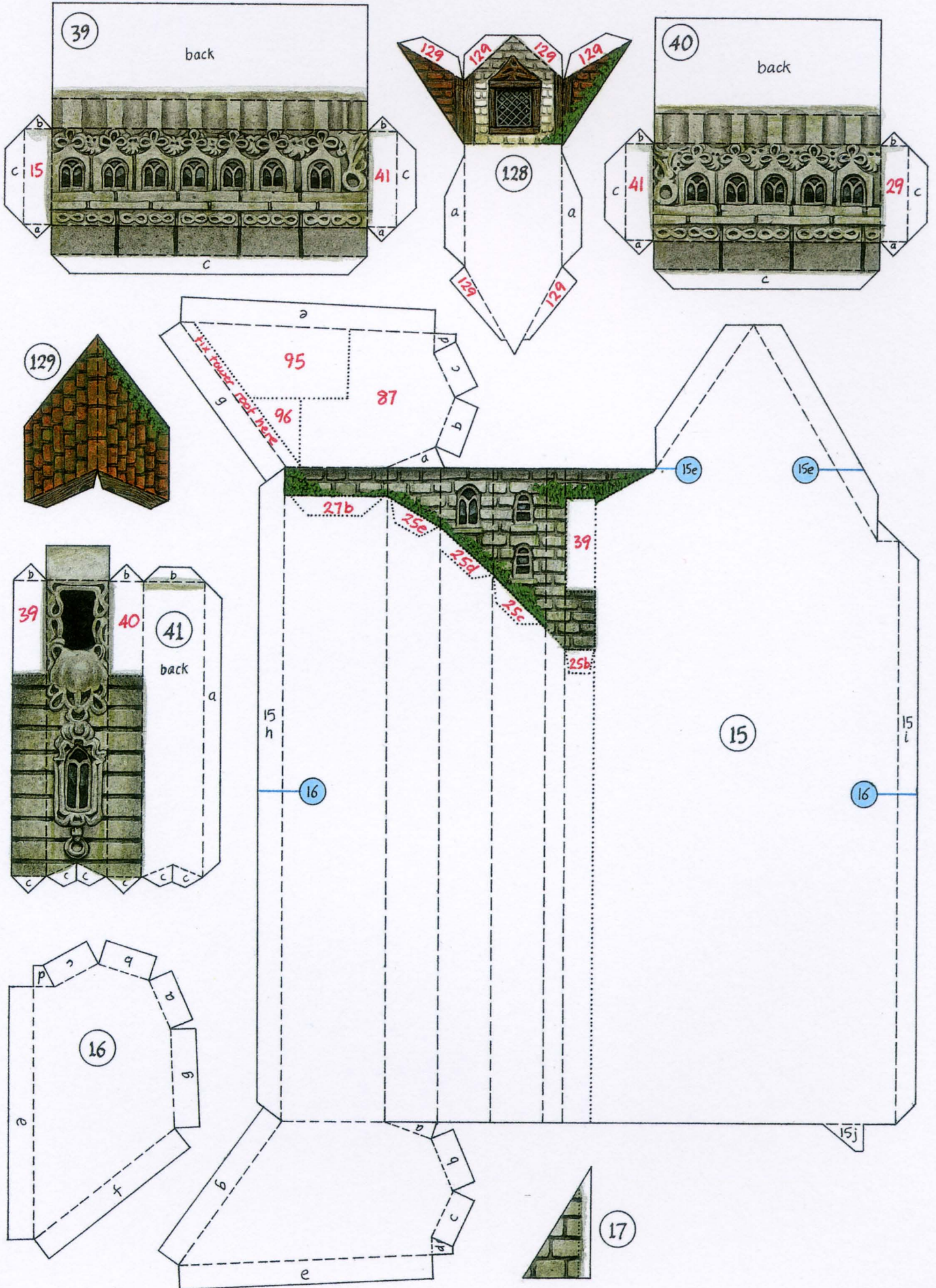

19

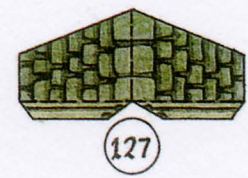
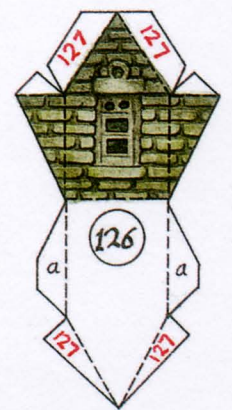
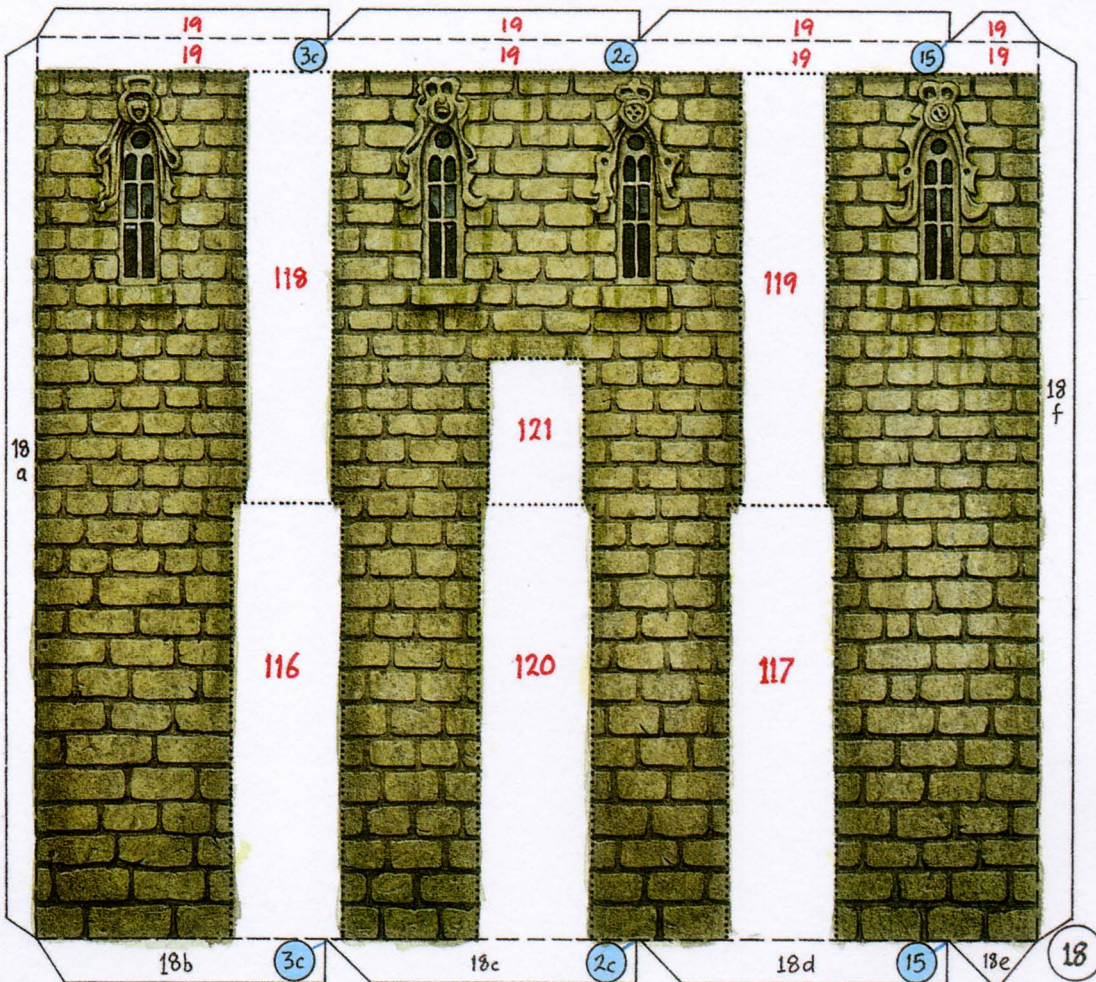
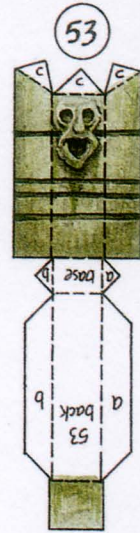
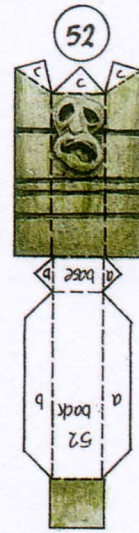
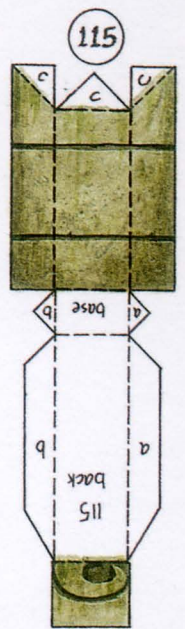
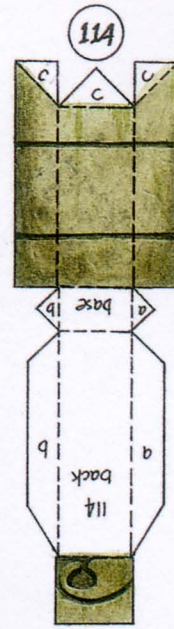
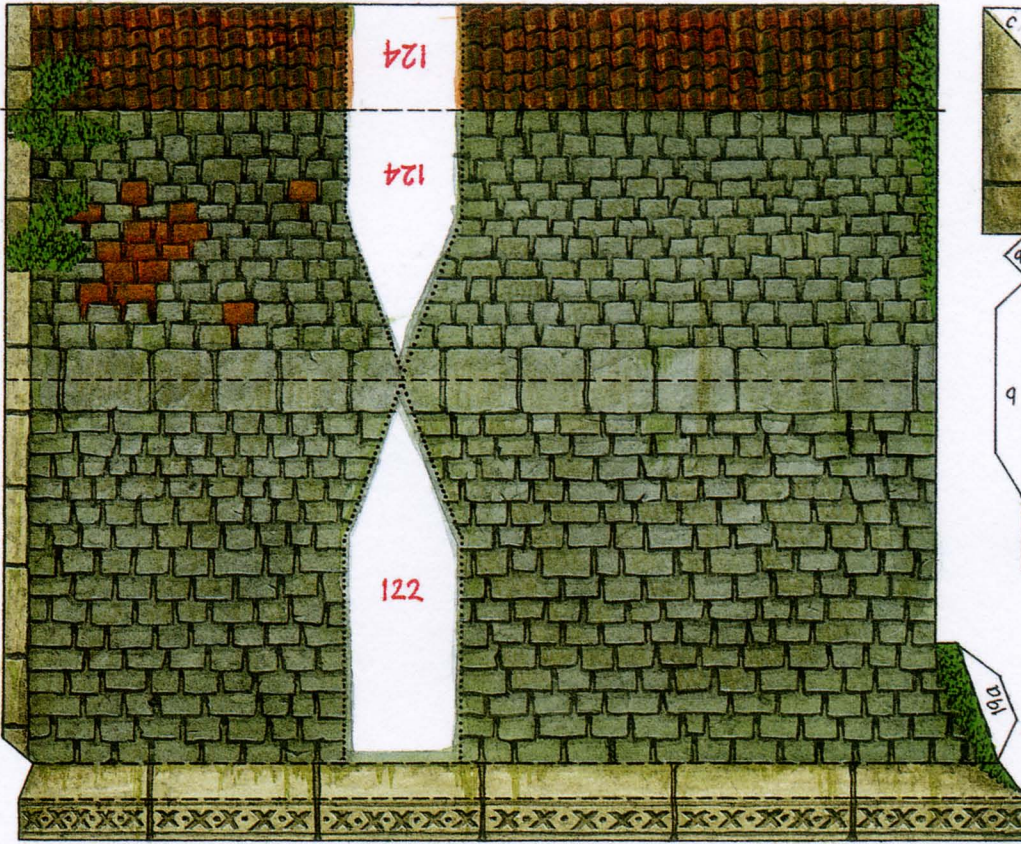

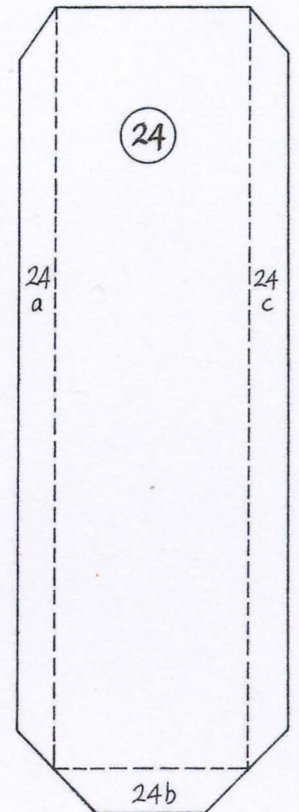
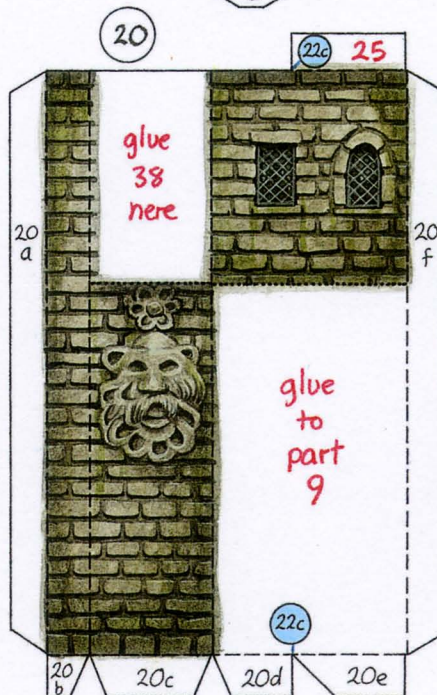
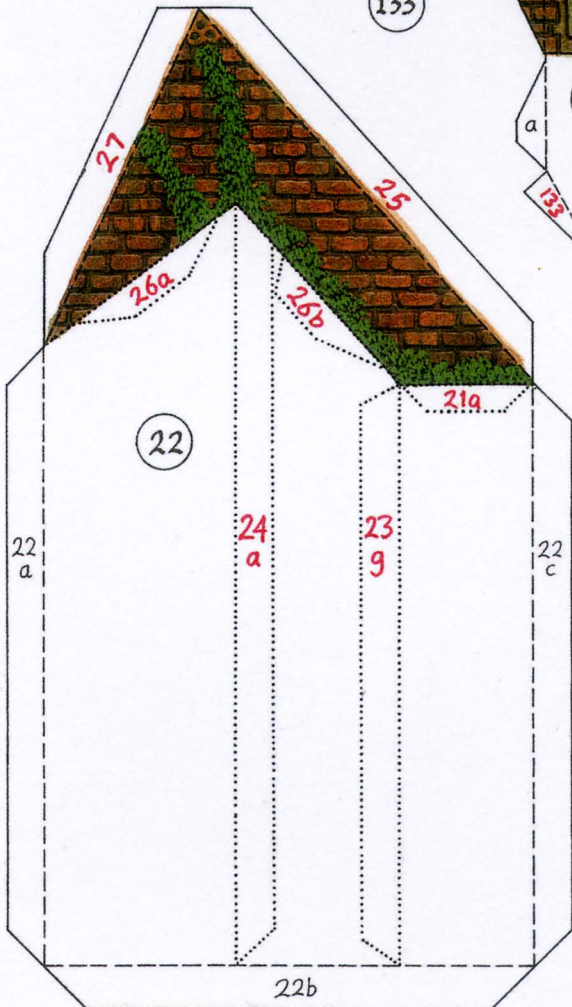
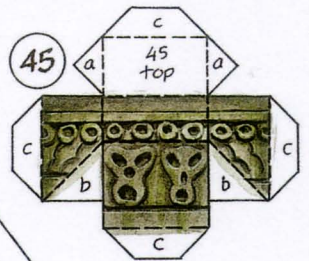
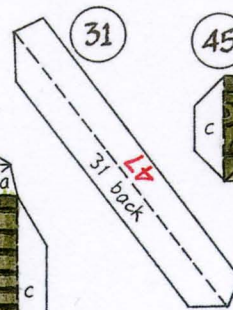
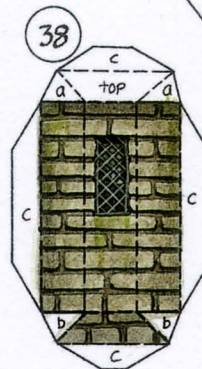
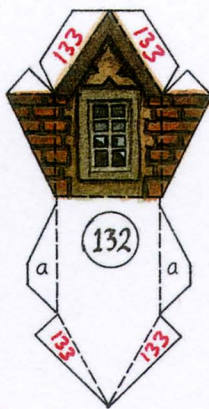
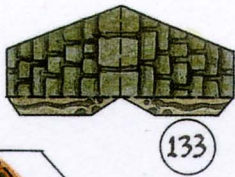
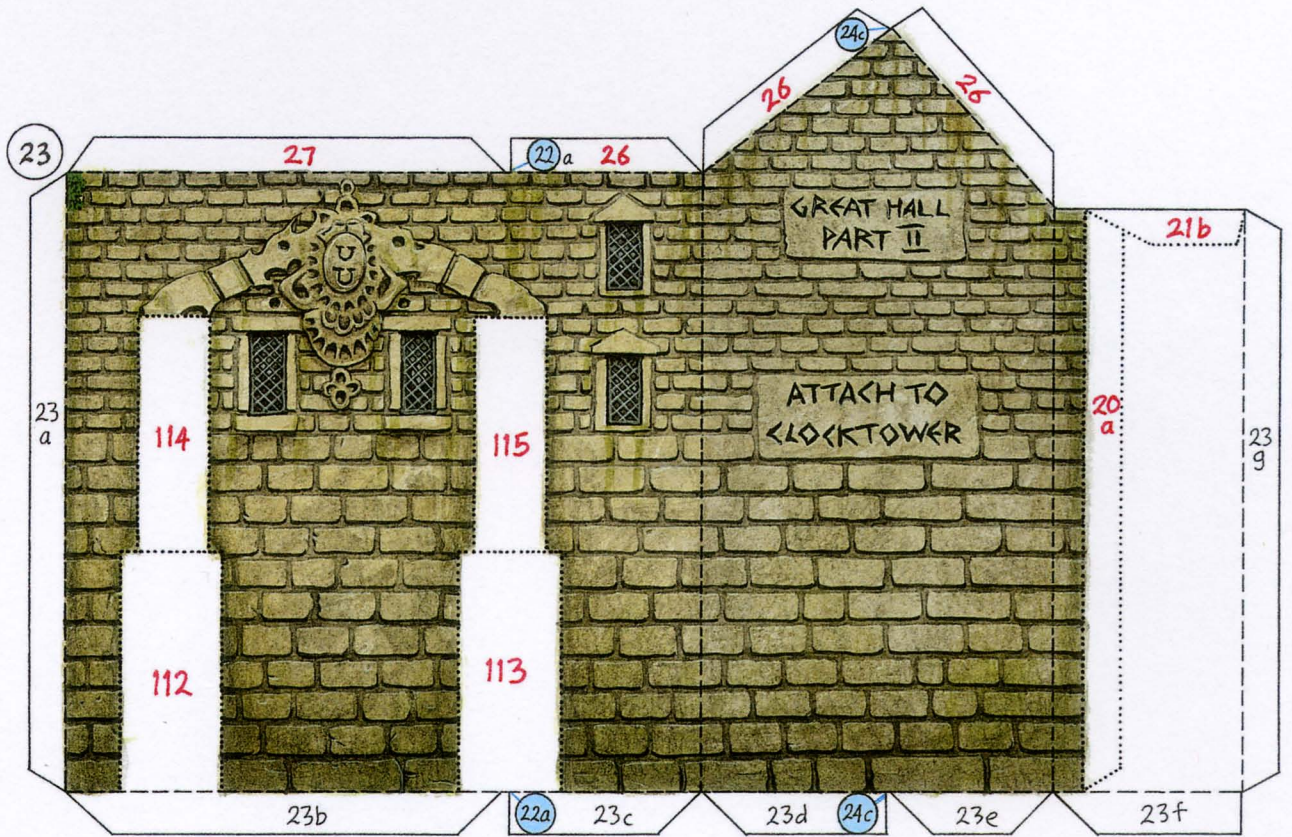

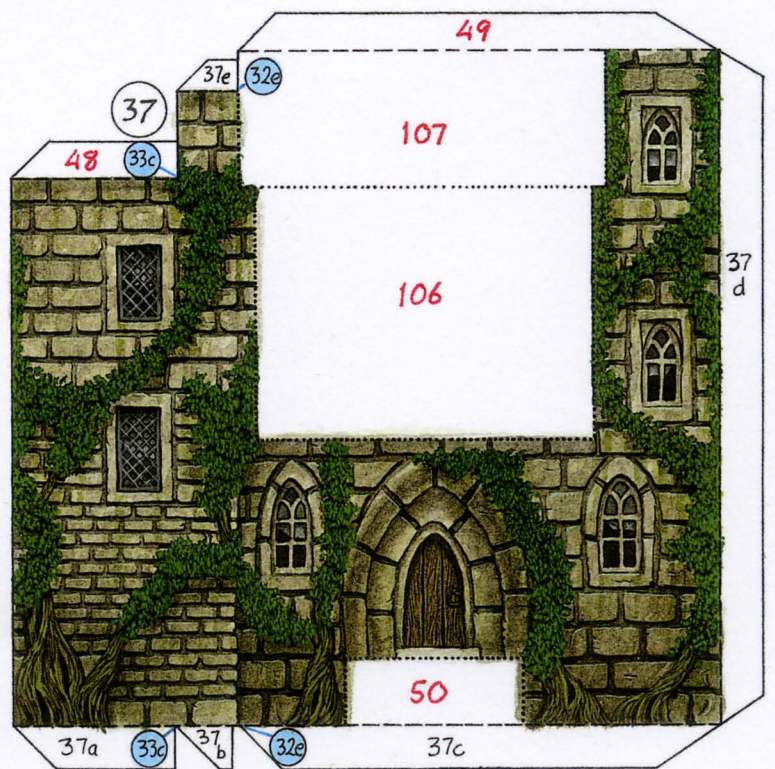
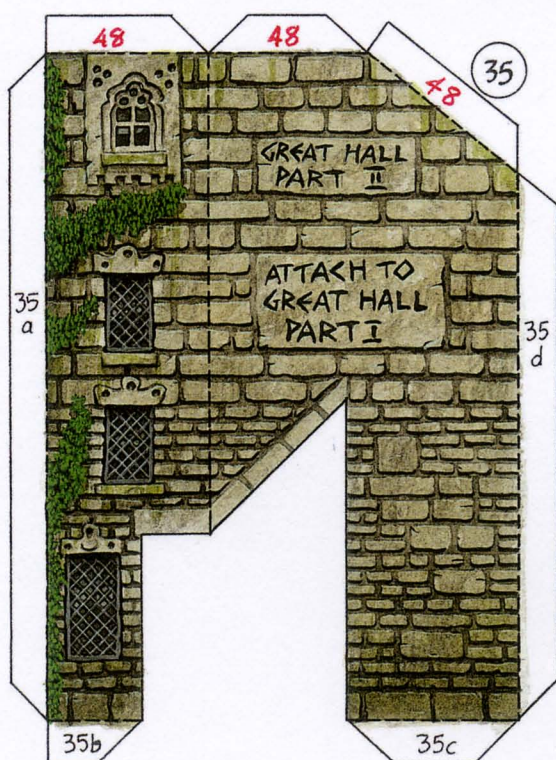
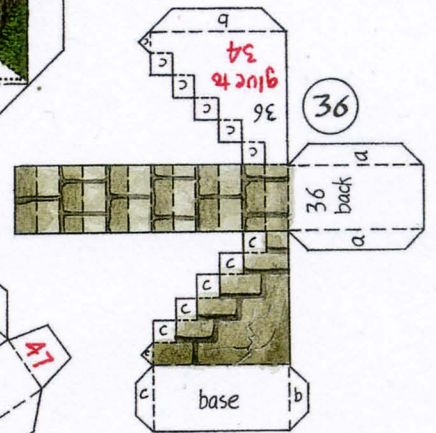
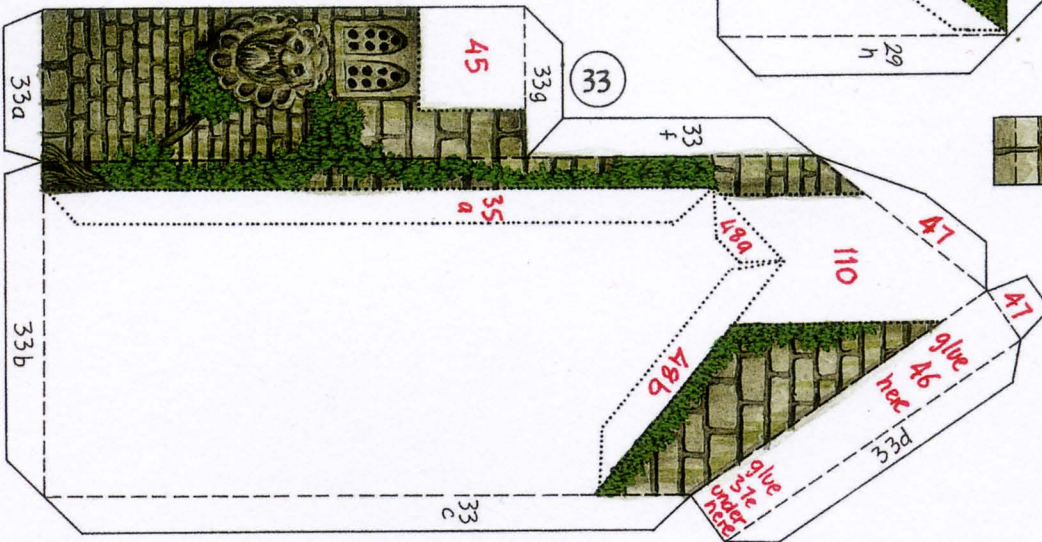
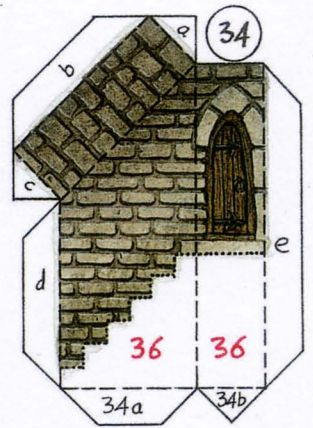
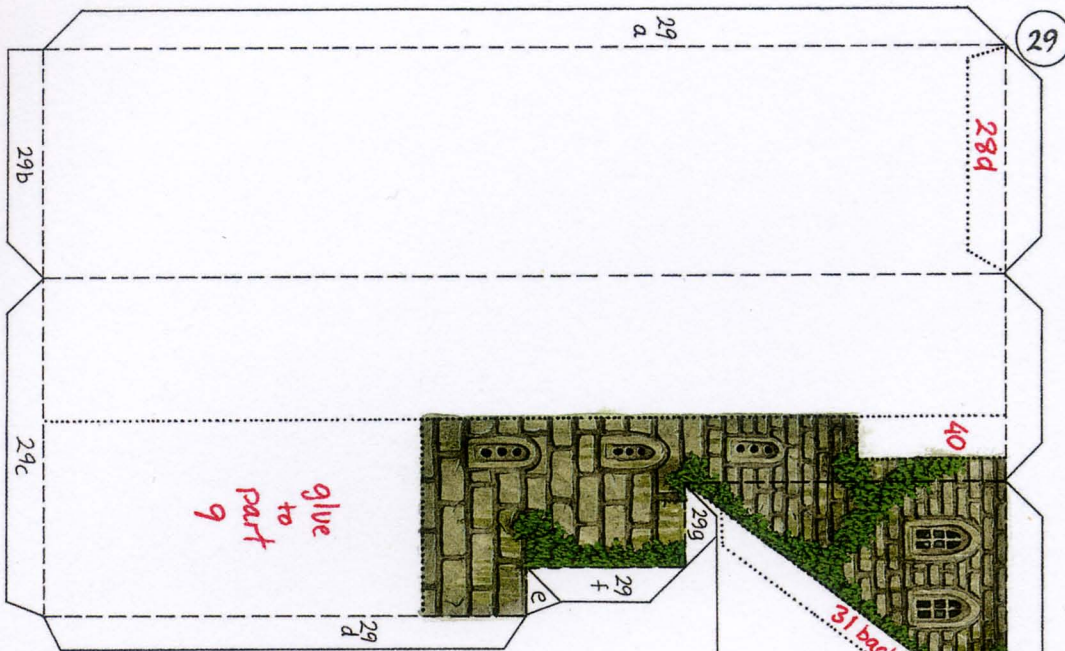

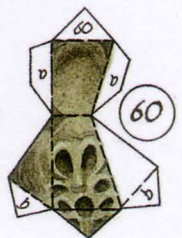
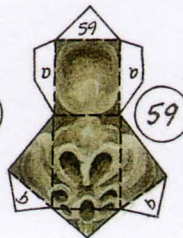
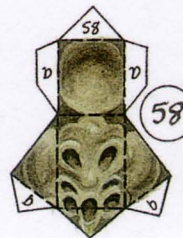
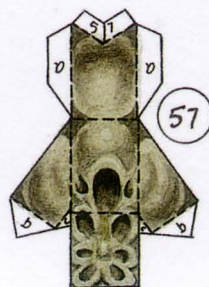
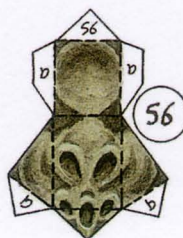
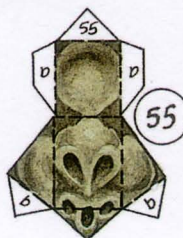
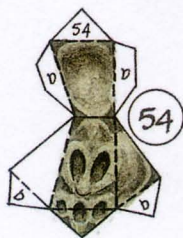
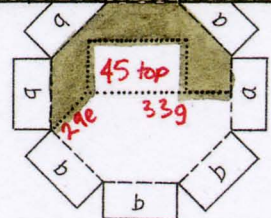
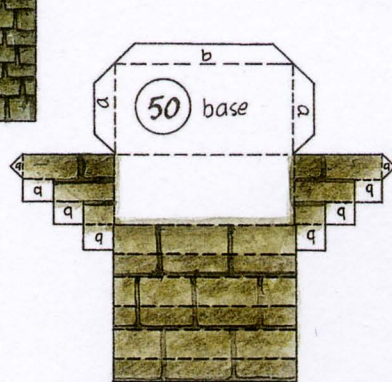
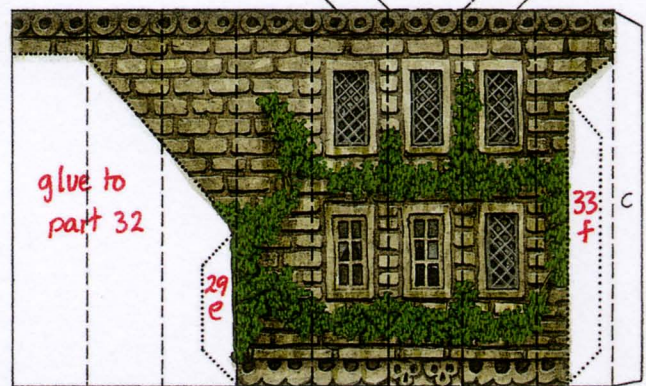
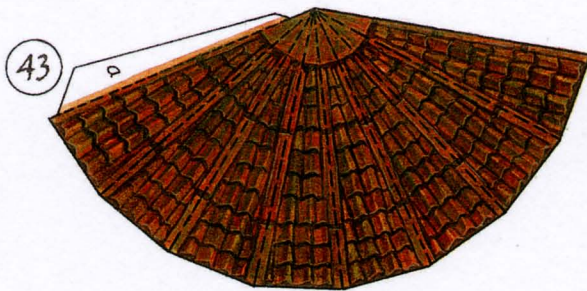
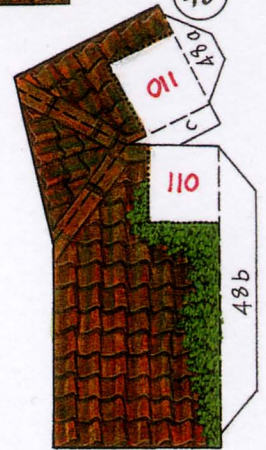
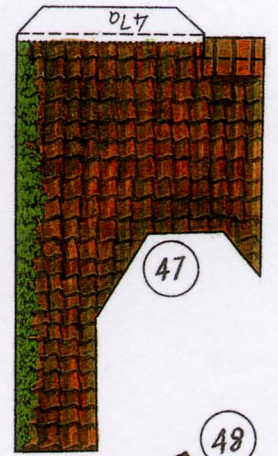
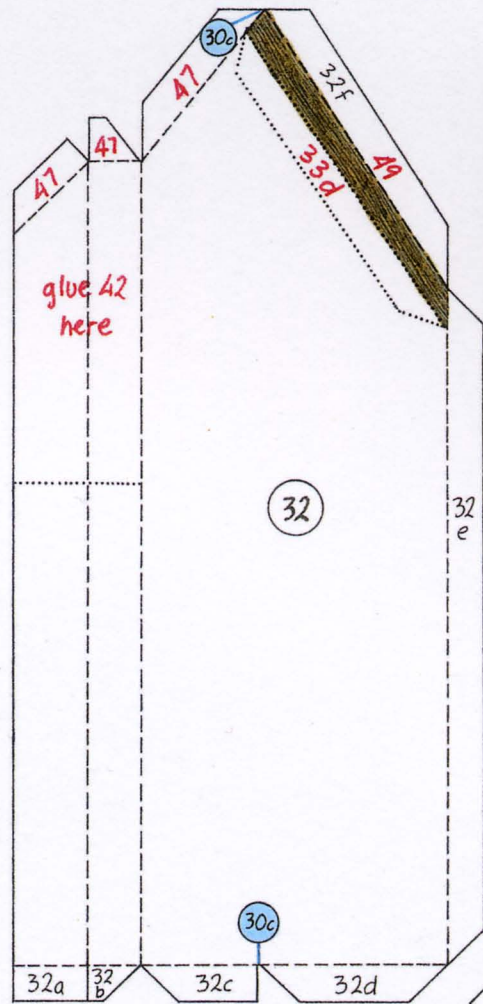
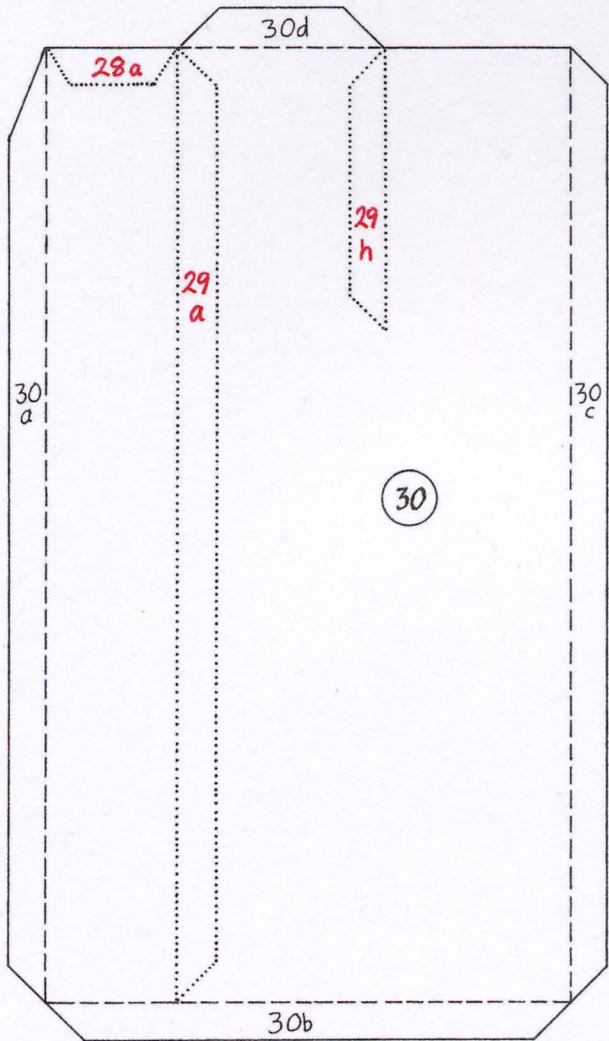

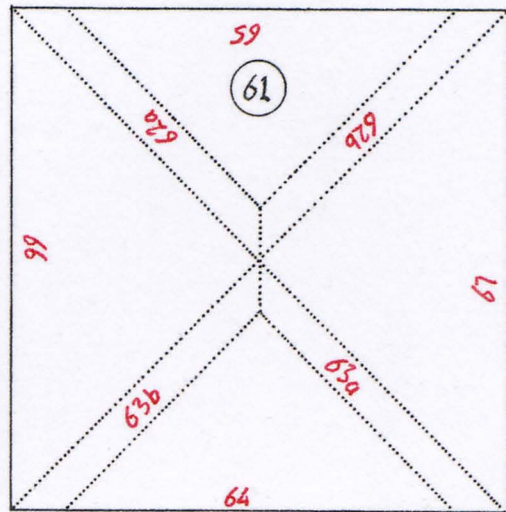
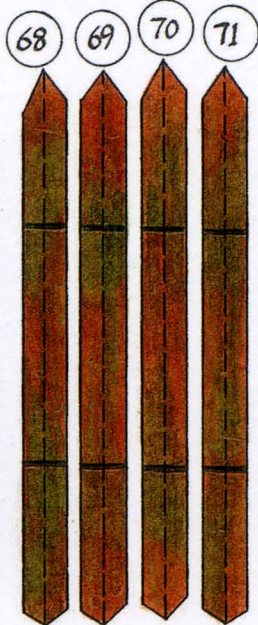
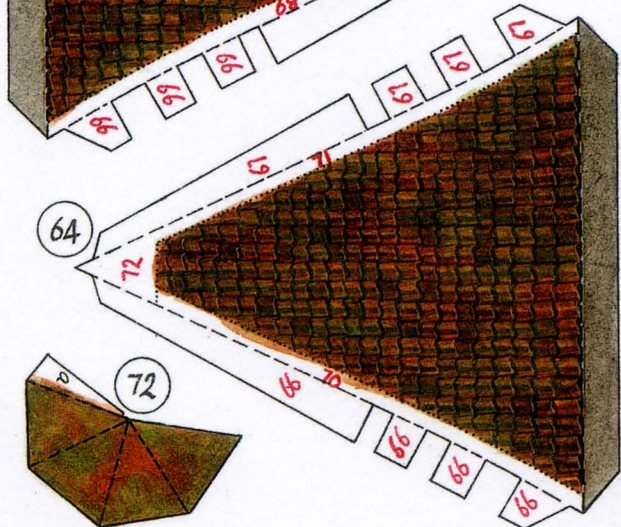
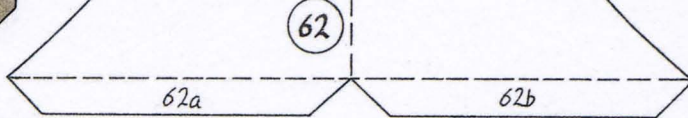
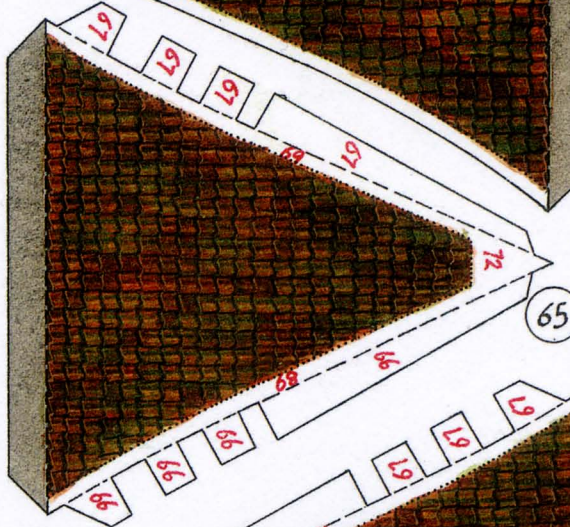
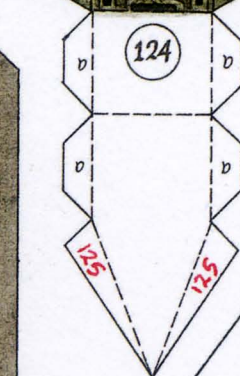
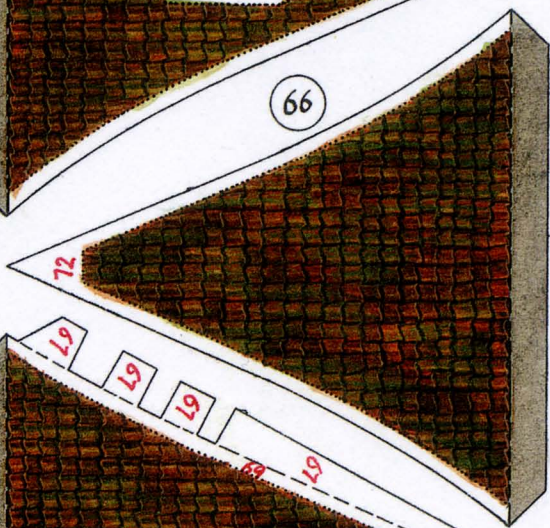
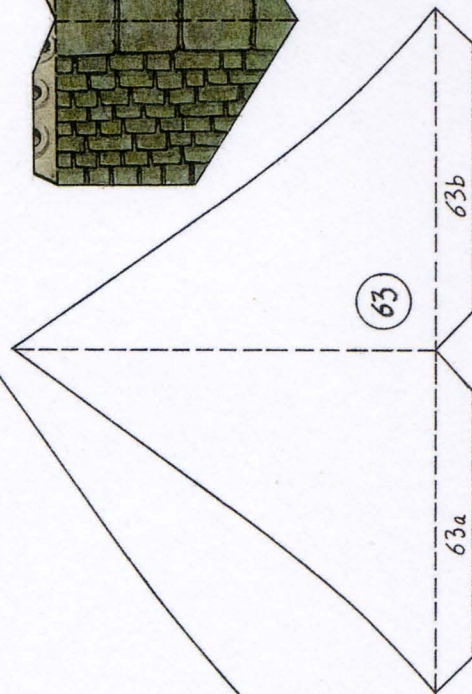
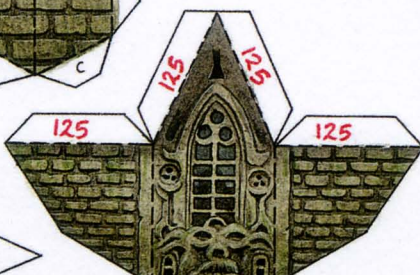
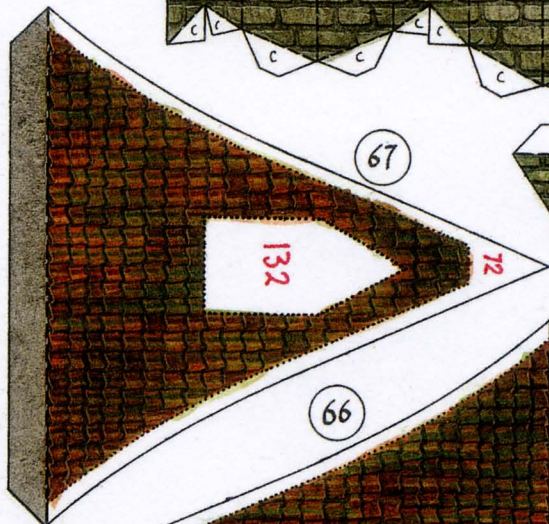
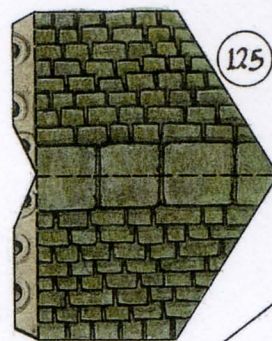
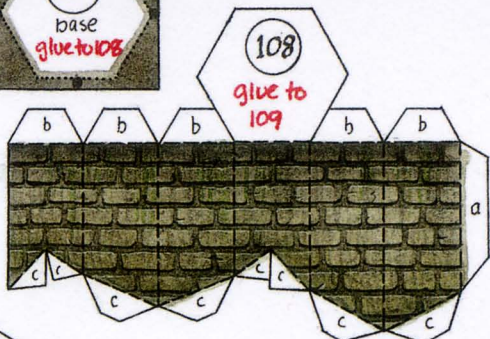
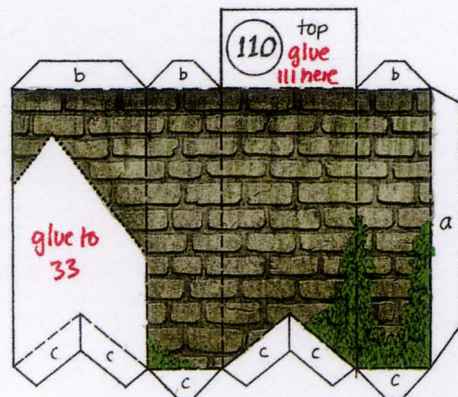
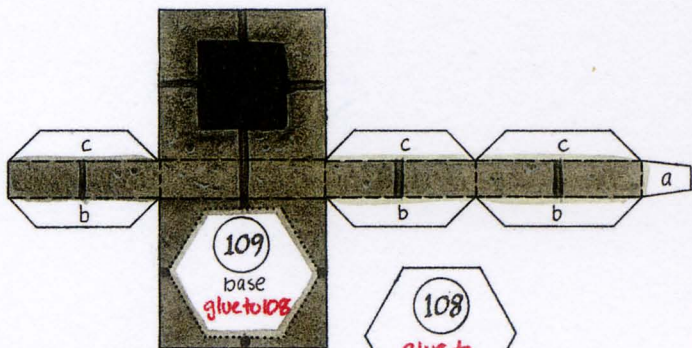

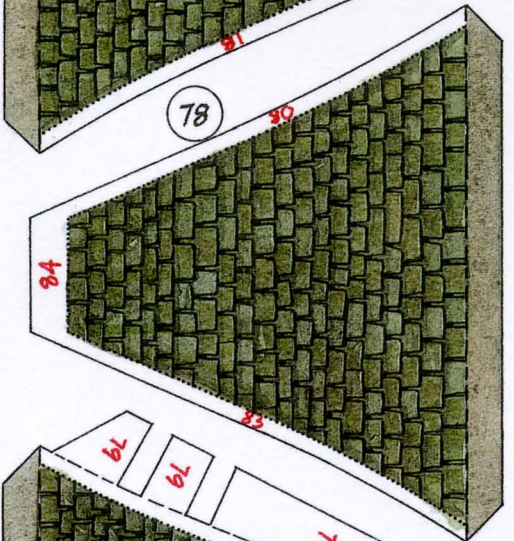
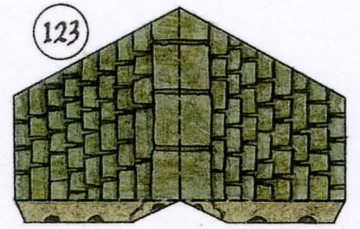
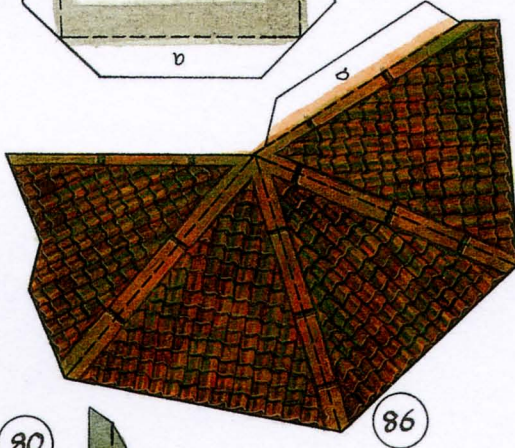
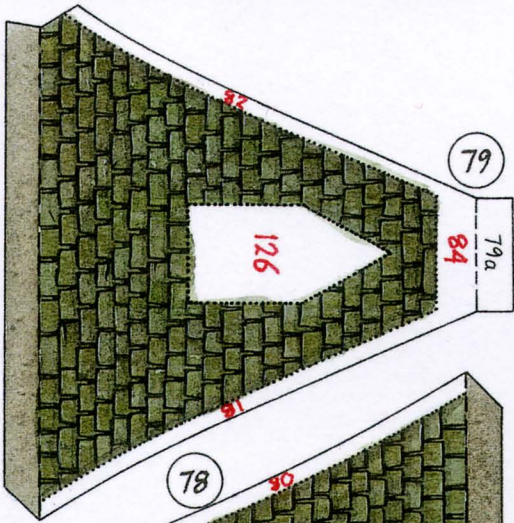
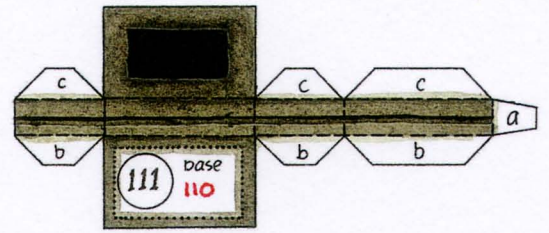
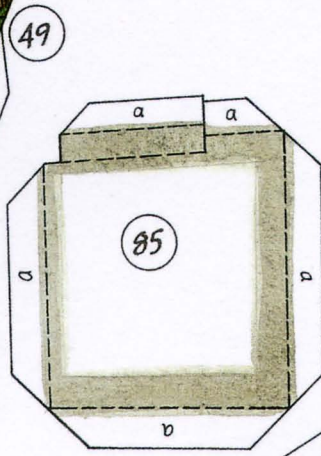
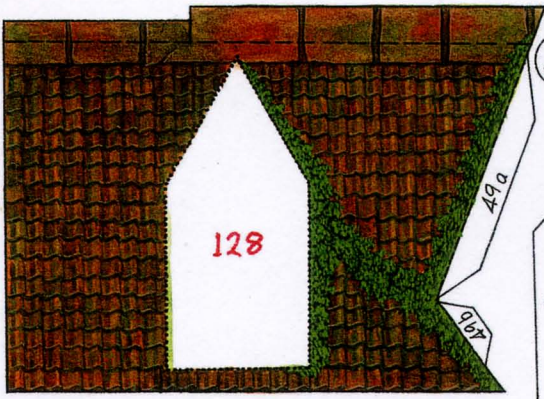

81

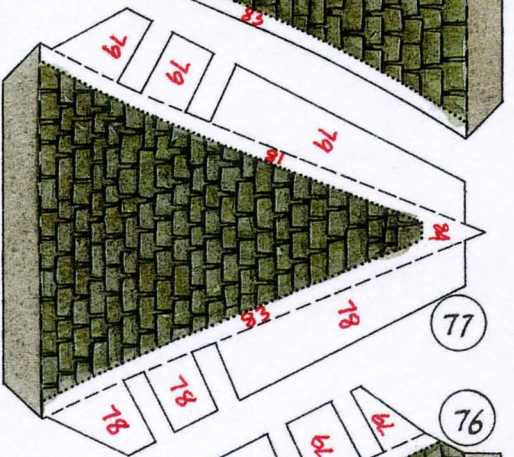
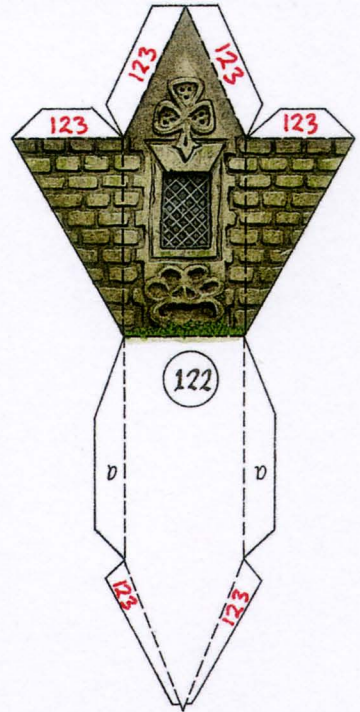
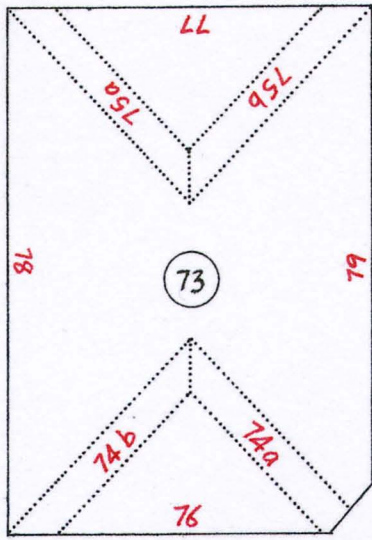

77

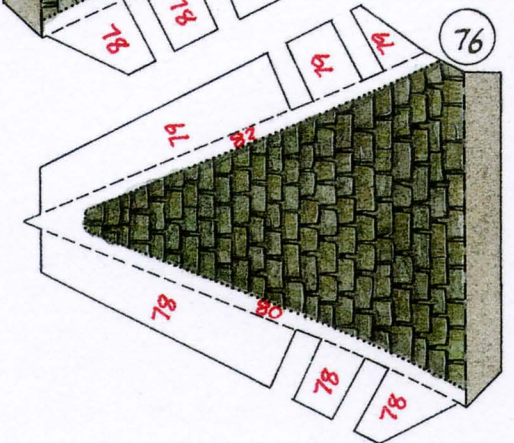

76

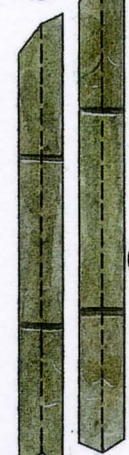

82

83

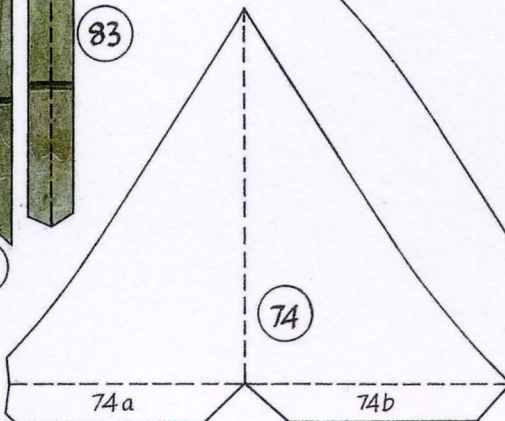

74

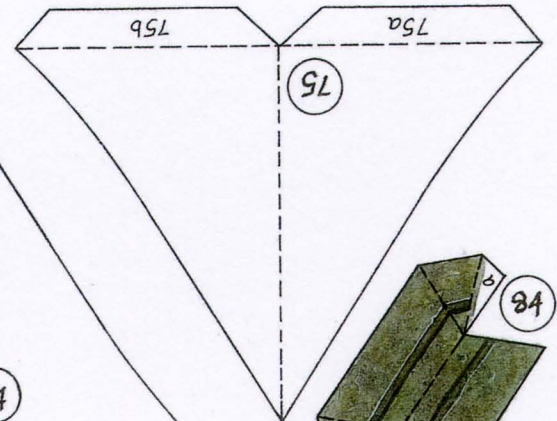

75

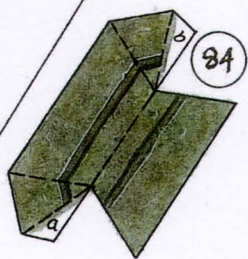

84

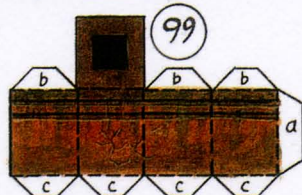
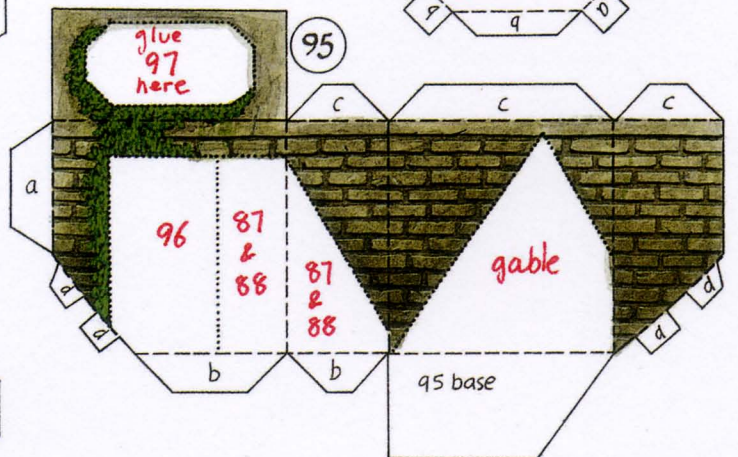
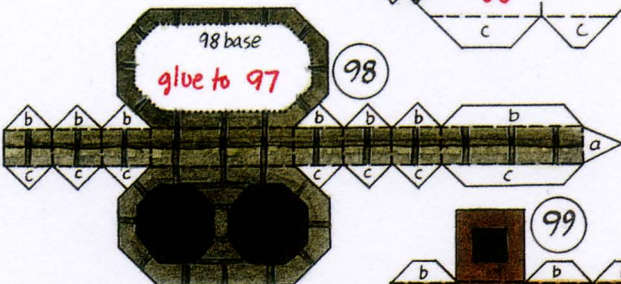
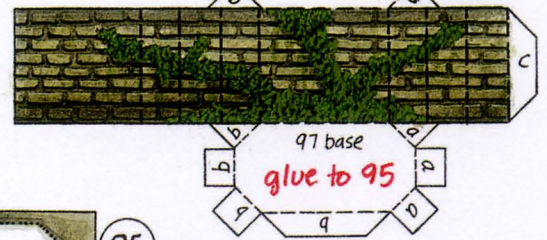
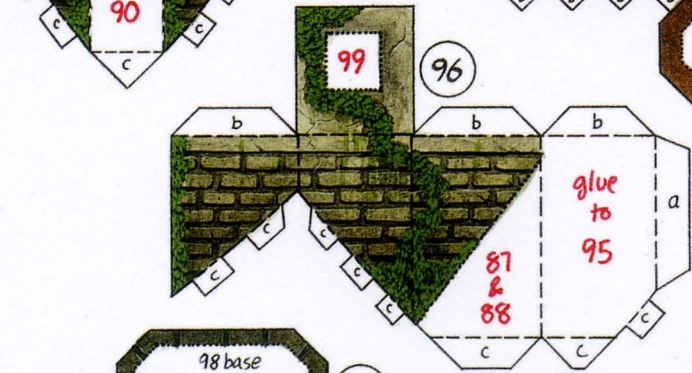
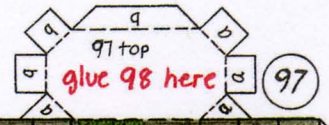
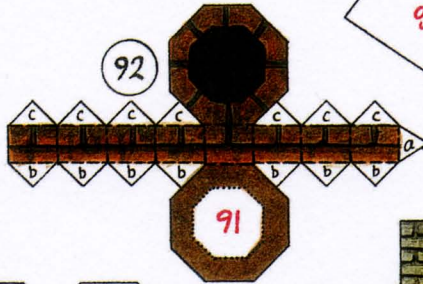
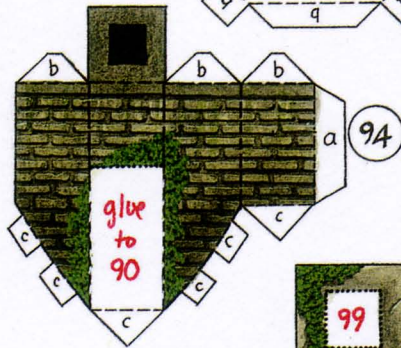
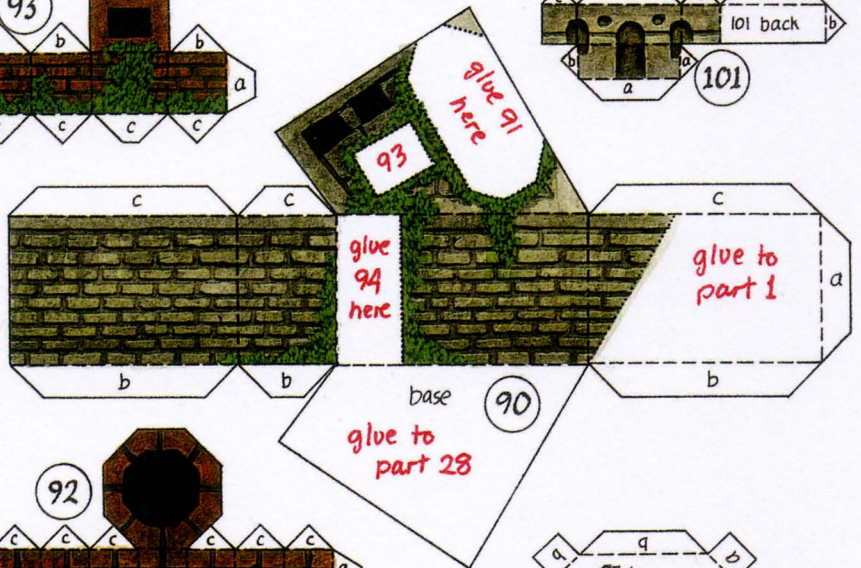
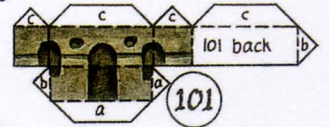
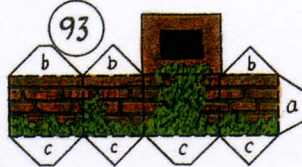
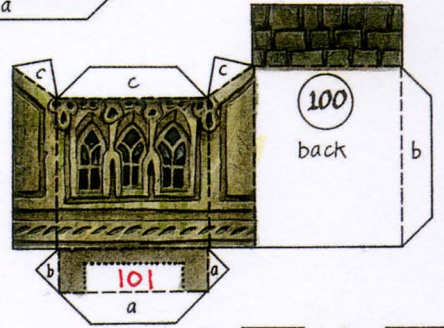
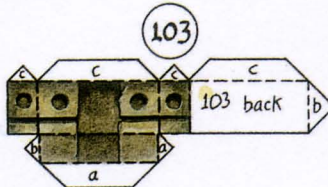
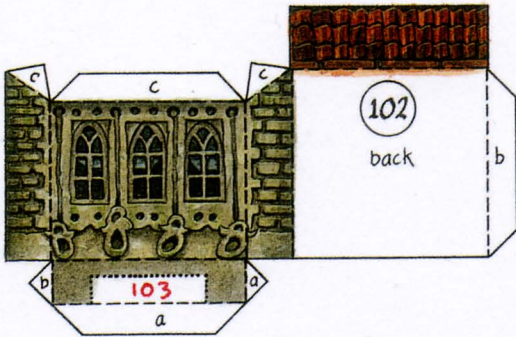
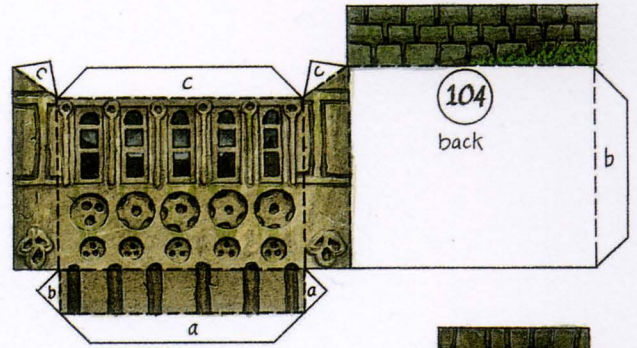
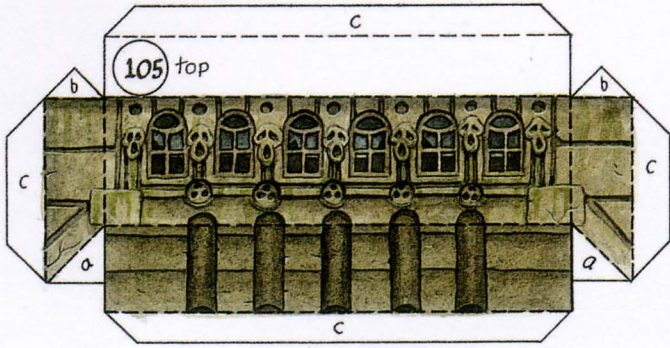

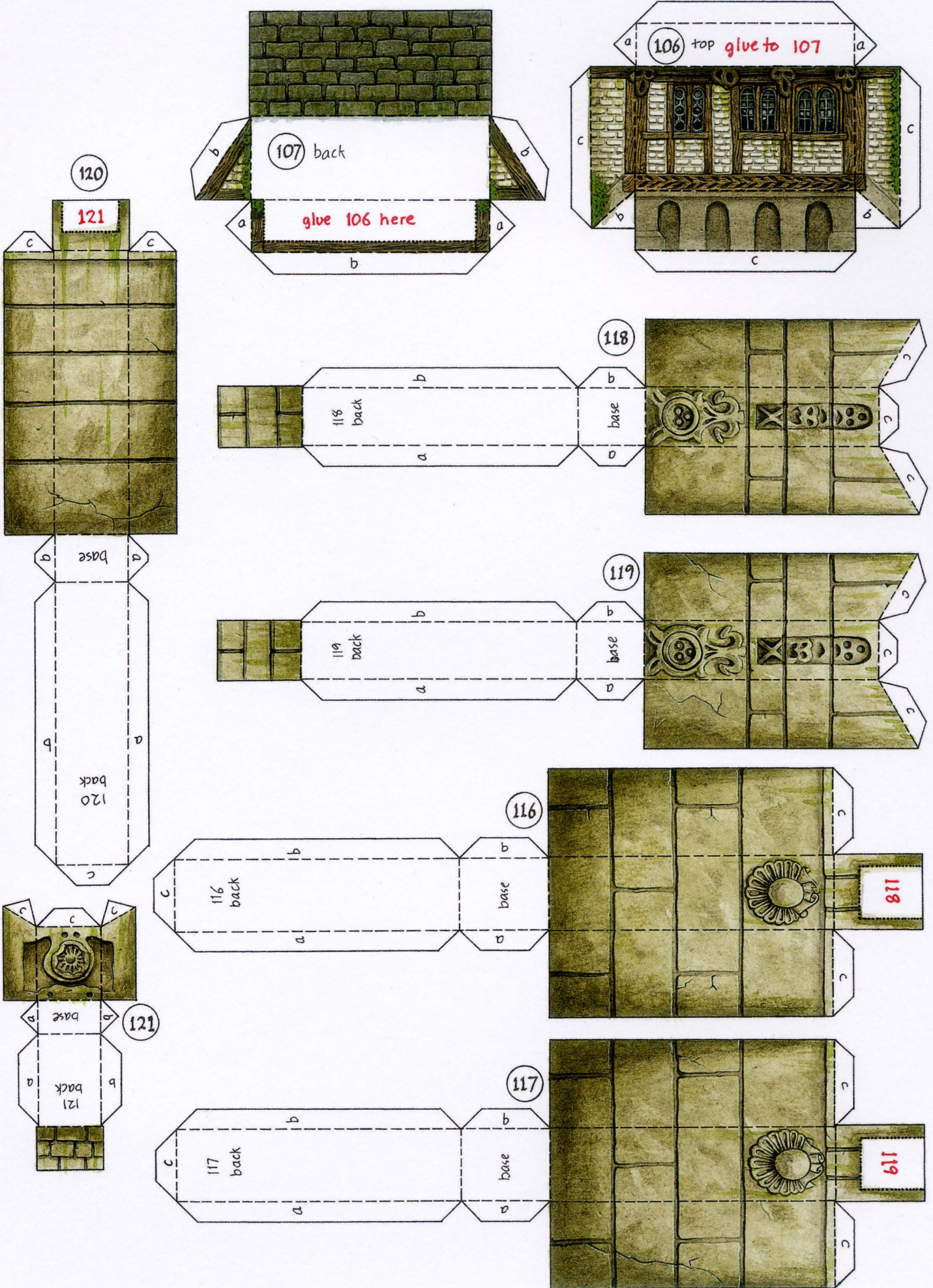

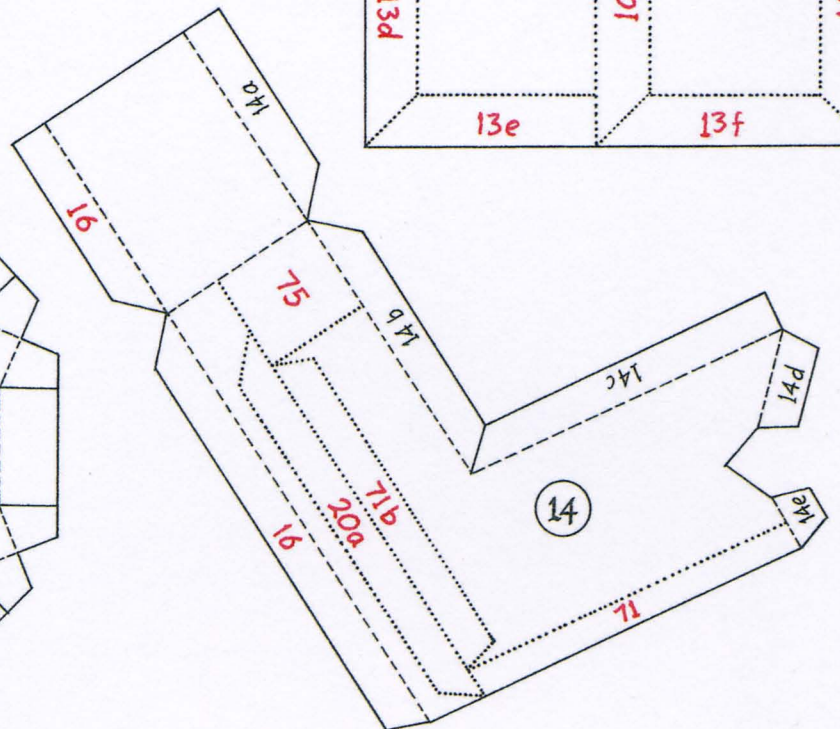
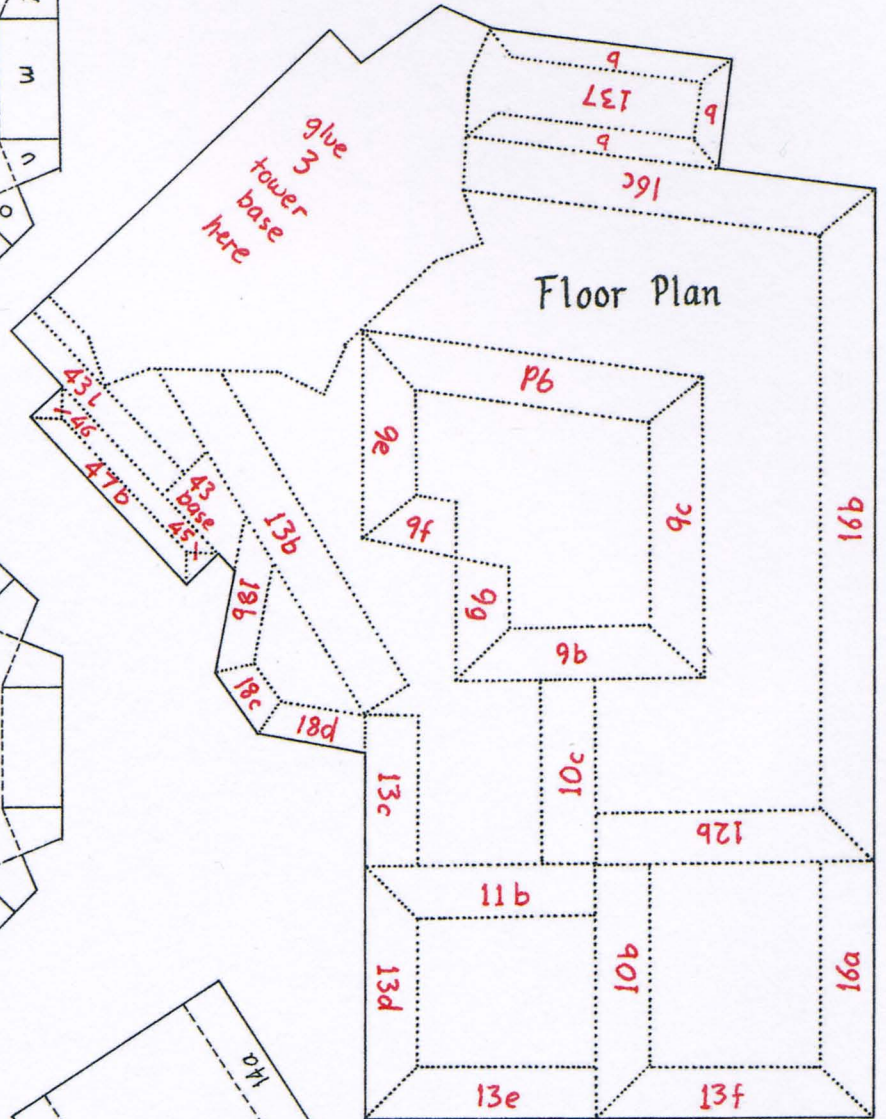
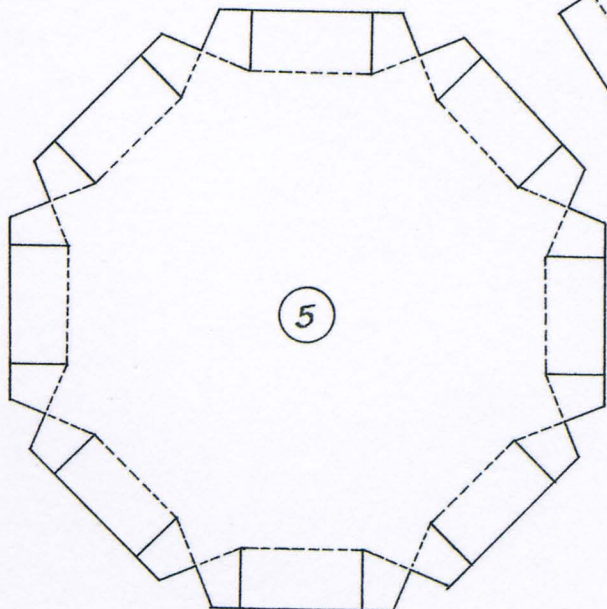
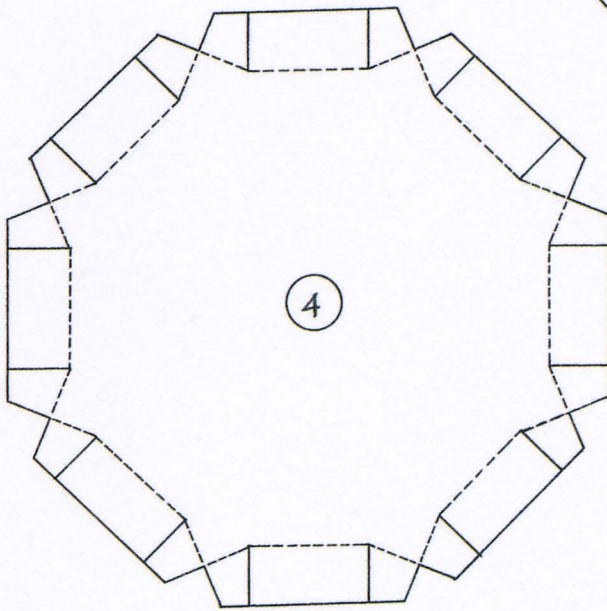
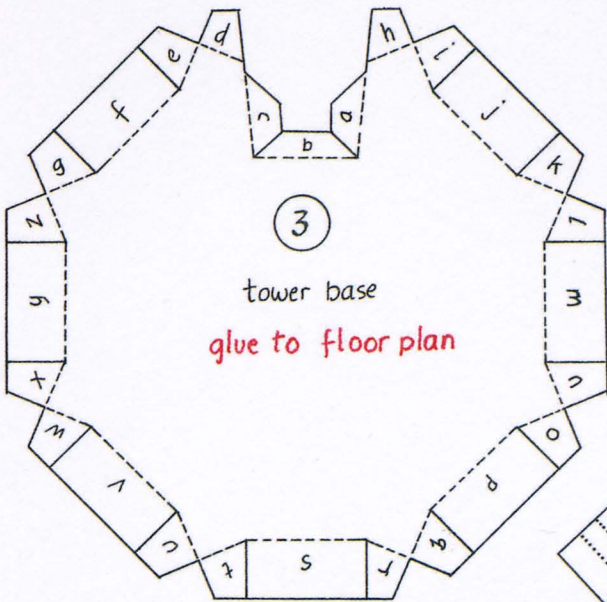

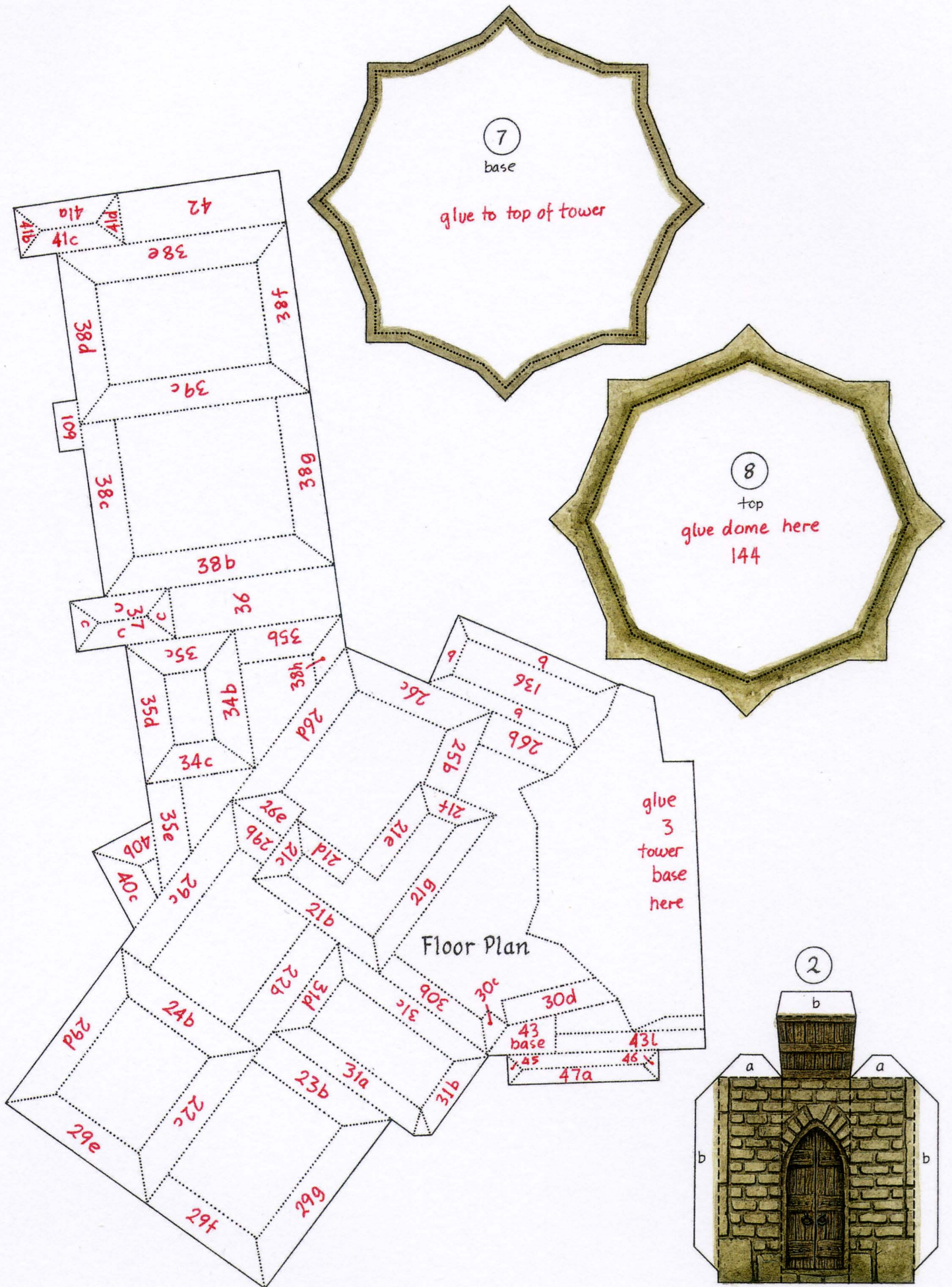

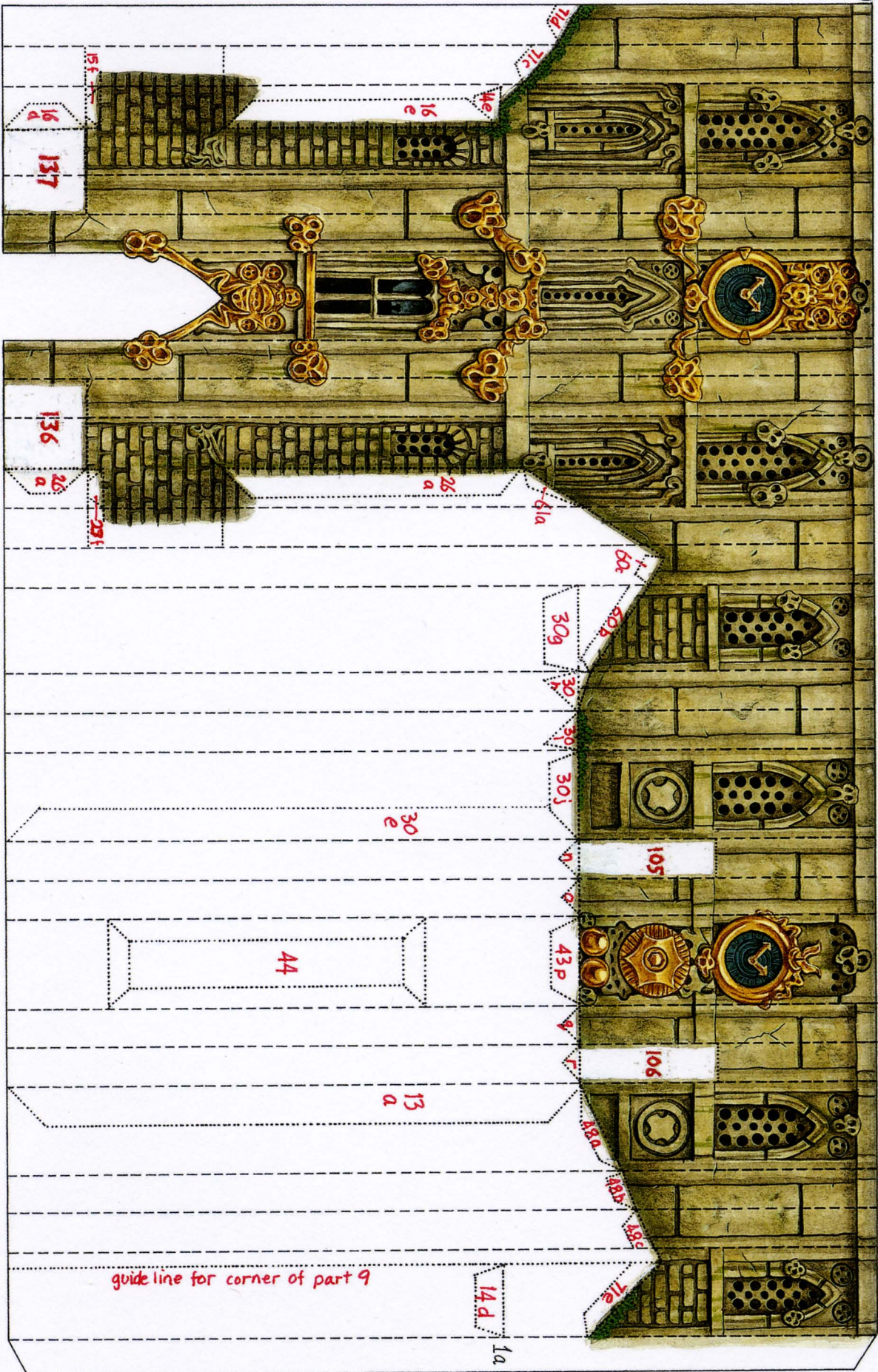

1

6

