

STAR TREK
THE NEXT GENERATION

the way
of d'era

THE ROMULAN STAR EMPIRE



SETTING

D'VALEK-CLASS SWIFT Warbird

Praetorian Fleet

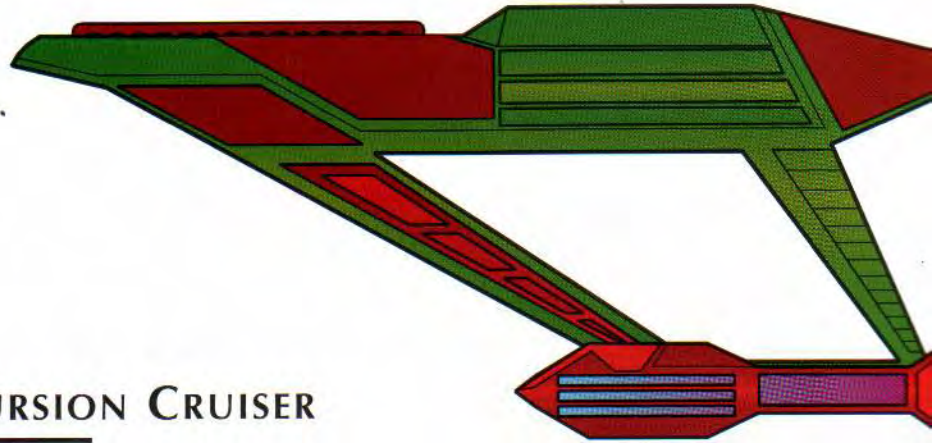
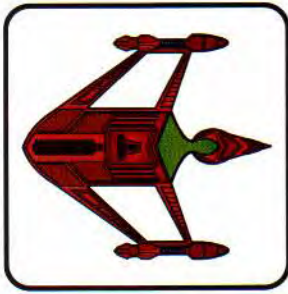

MERET-CLASS INCURSION CRUISER

Kassan Fleet

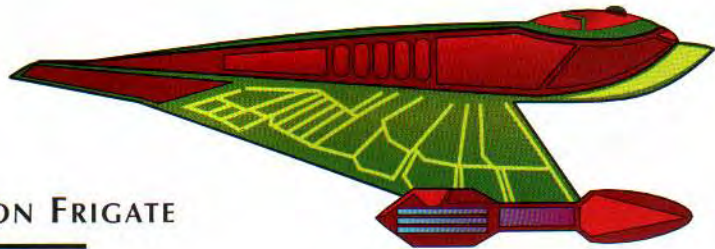

D'VIRIN-CLASS INCURSION FRIGATE

Kassan Fleet

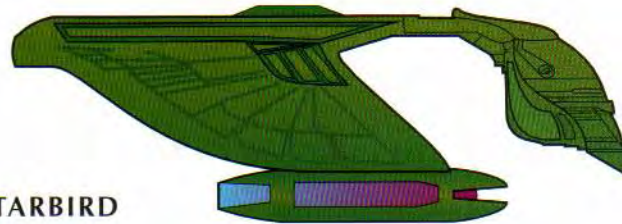

T'RASUS-CLASS LIGHT Starbird

Command Fleet

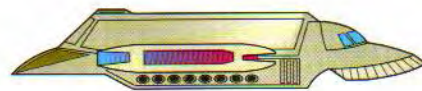
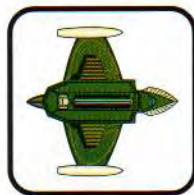

DERESUS-CLASS HEAVY SCOUT

Praetorian Fleet



THETA-CLASS SWIFT COURIER

Othan Fleet

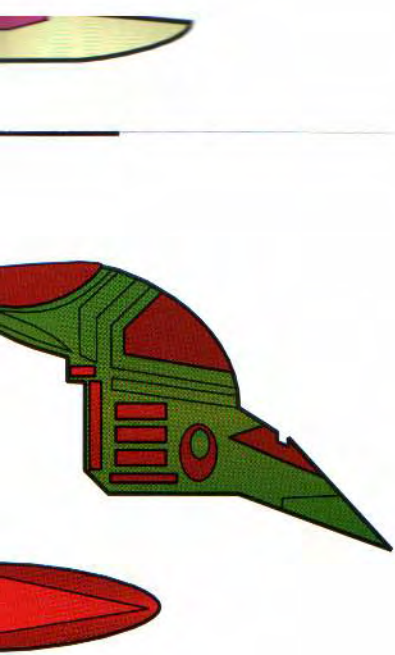

SHIP SIZE REEFER

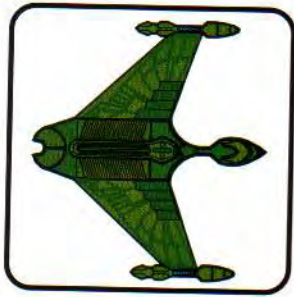

VERELEUS-CLASS DREADNOUGHT

Command Fleet

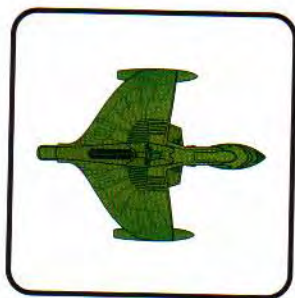
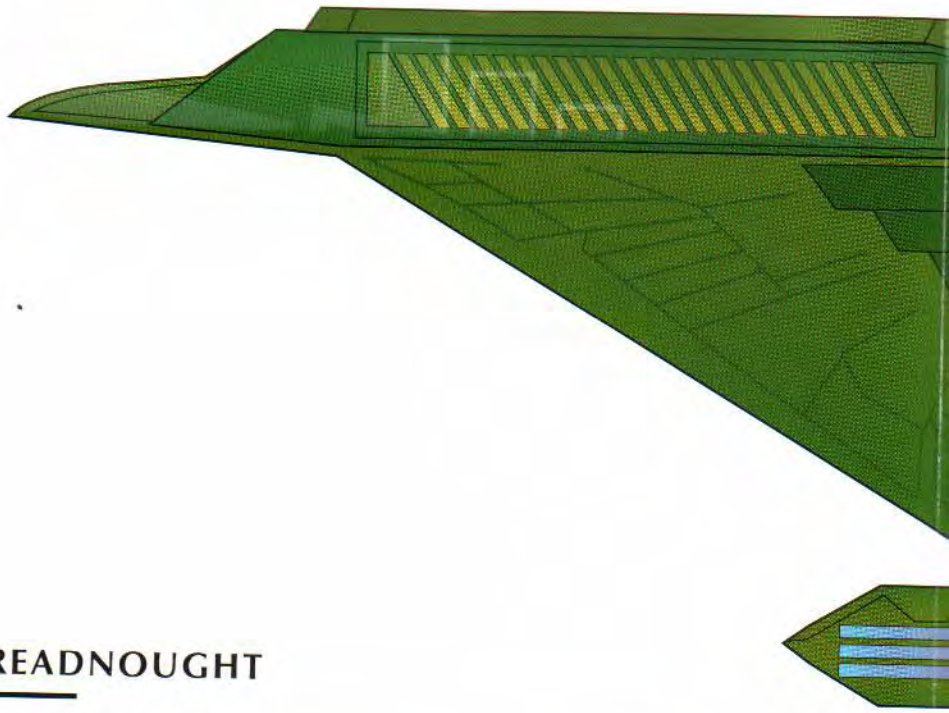

D'DERIDEX-CLASS HEAVY WARBIRD

Command Fleet

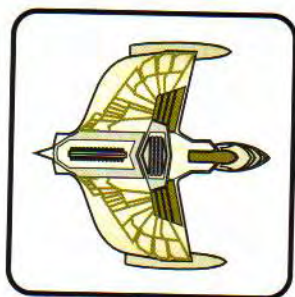
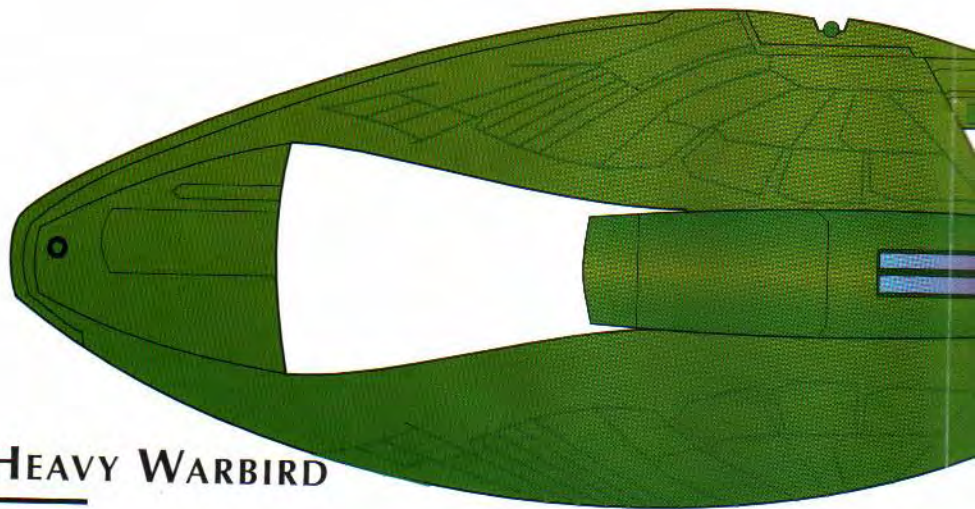

D'VALEK-CLASS SWIFT WARBIRD

Praetorian Fleet

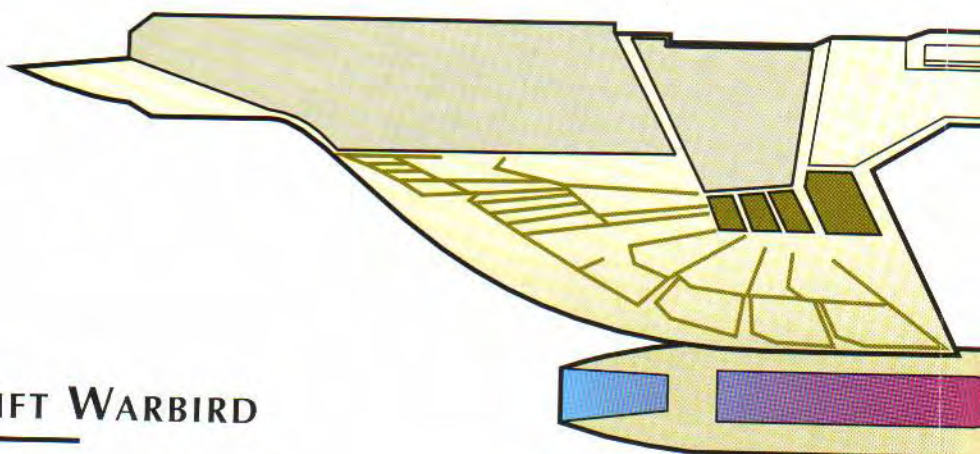

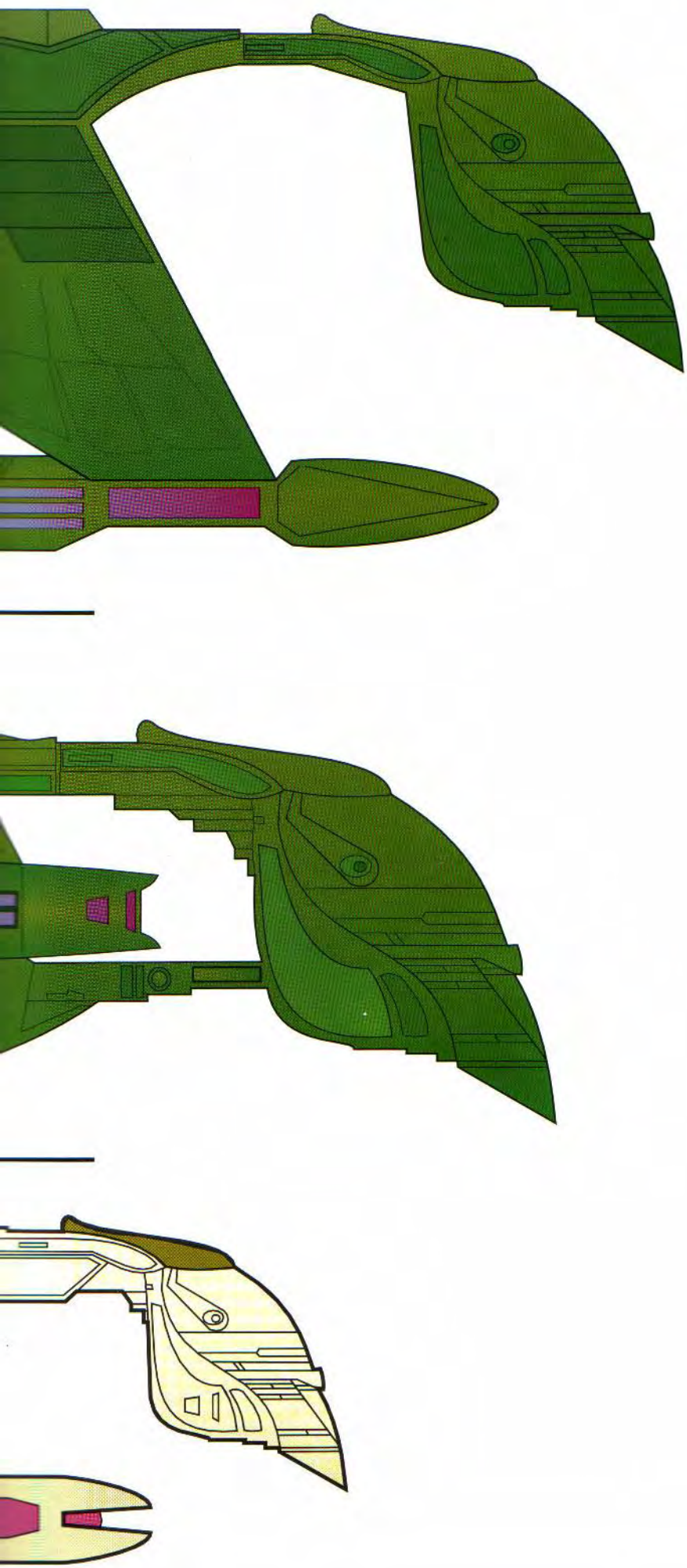

REFERENCE CHART

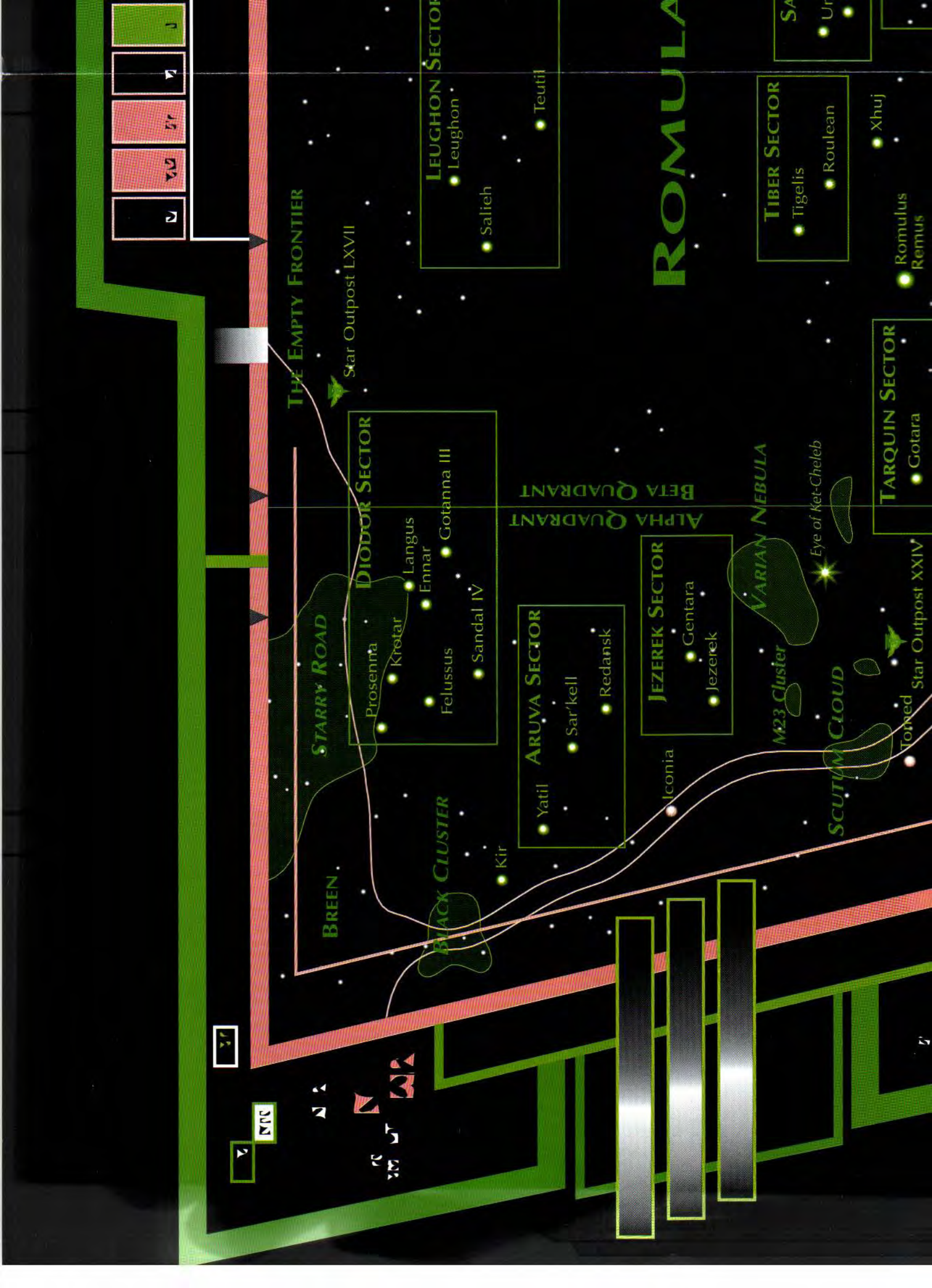

ROMULA

THE EMPTY FRONTIER

Star Outpost LXVII

DIODOR SECTOR

STARRY ROAD

BREEN

BLACK CLUSTER

BETA QUADRANT

ALPHA QUADRANT

ARUVA SECTOR

JEZEREK SECTOR

VARIAN NEBULA

SCUTUM CLOUD

M23 Cluster

Eye of Ket-Cheleb

TARQUIN SECTOR

LEUGHON SECTOR

TIBER SECTOR

Xhuj

Romulus Remus

Prosennta

Krotar

Langus Ennar

Gotanna III

Felussus

Sandal IV

Yatil

Sar'kell

Redansk

Gentara

Jezerek

Iconia

Salieh

Teutil

Tigelis

Rouleau

Gotara

Star Outpost XXIV

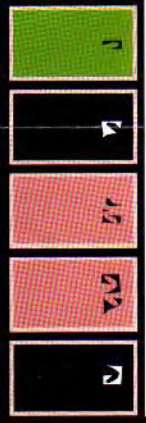

| | | | |
|--|--|--|--|
| | | | |
| | | | |
| | | | |
| | | | |

| | | | |
|--|--|--|--|
| | | | |
| | | | |
| | | | |
| | | | |

| | | | |
|--|--|--|--|
| | | | |
| | | | |
| | | | |
| | | | |

| | | | |
|--|--|--|--|
| | | | |
| | | | |
| | | | |
| | | | |



GHON SECTOR
ghon

- Teutij

TAURHAI UNITY • Chit'an

V'VARIAN SECTOR

- Paxar
- Gains

Star Outpost CXII

TULLUS SECTOR

- Farlorn
- Peren
- Pollus
- Drovna

DASHA SECTOR

- Torek
- Dasha Verta
- Vertilia

MULAN STAR EMPIRE

SAMNAR SECTOR

- Ossec
- Umbrios
- Samnar

SECTOR

- lean
- Xhuj
- Hybera
- Quatel

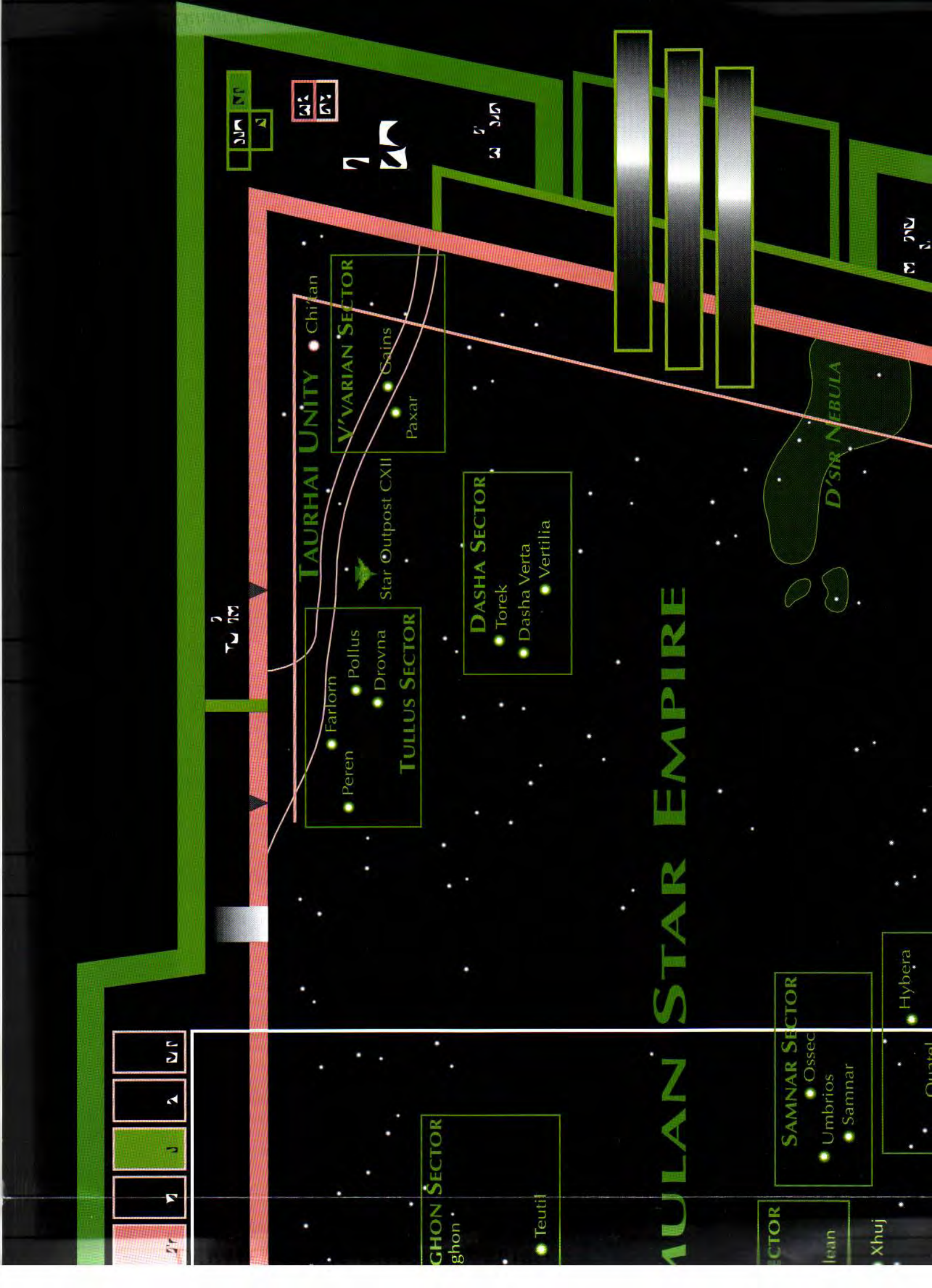
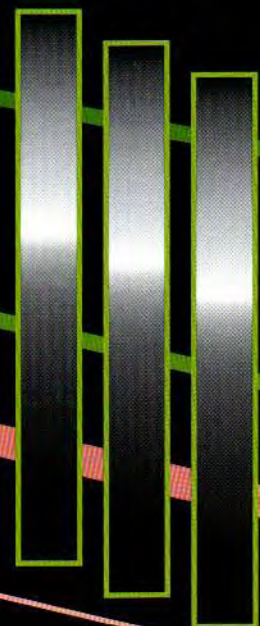

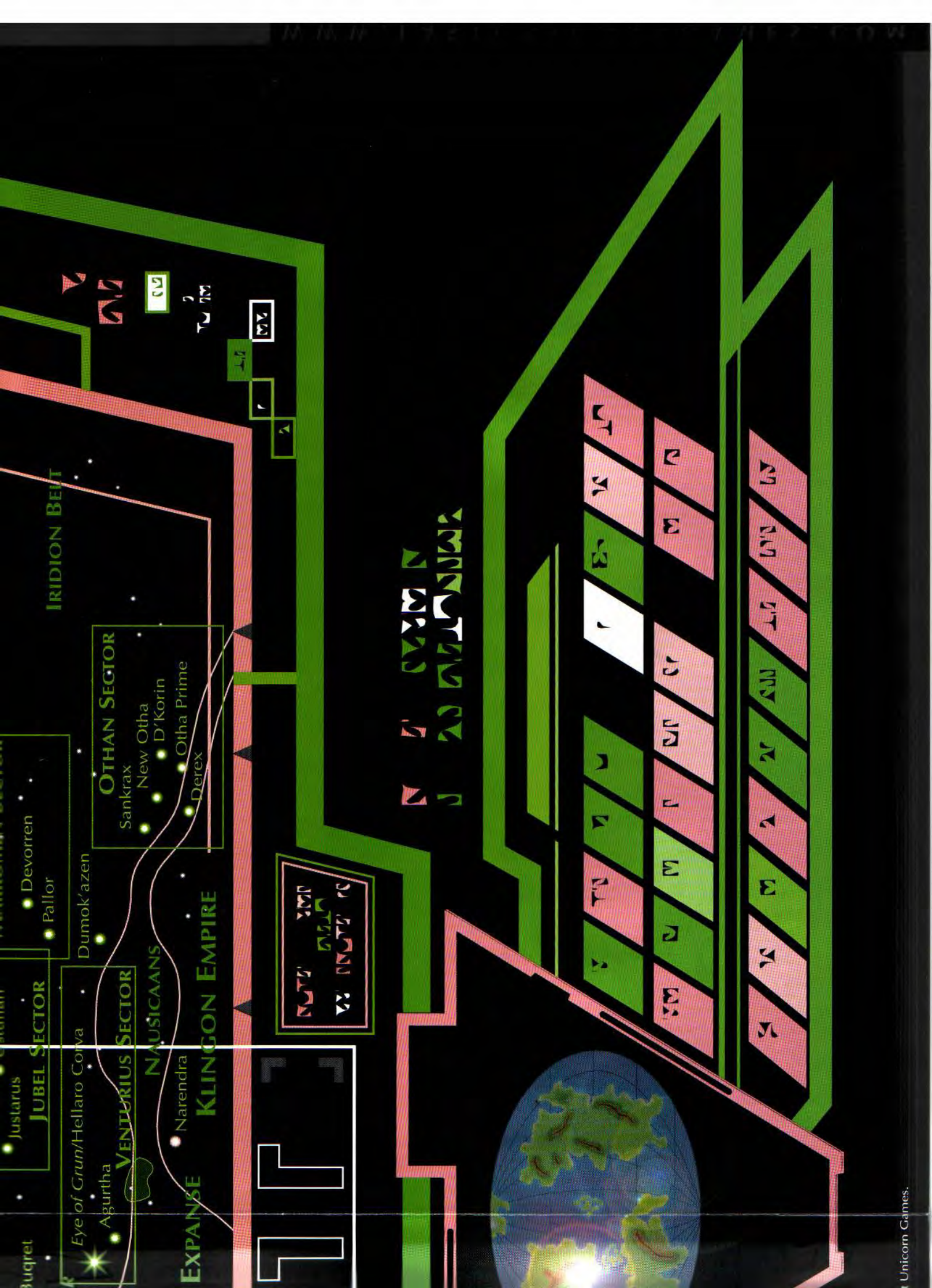

IRIDION BELT

OTHAN SECTOR
Sankrax
New Otha
D'Korin
Otha Prime
Derex

JUBEL SECTOR
Justarus
Devorren
Pallor

VENTURIUS SECTOR
Eye of Grun/Hellaro Coriva
Agurtha

NAUSICAANS
Narendra

EXPANSE
KLINGON EMPIRE

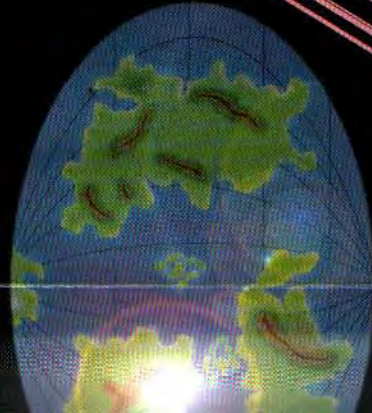

ROMULAN UNIFORM AND RANK



COMMAND FLEET
Centurion (*Command*)



PRAETORIAN FLEET
Commander (*Tactical*)



OTHAN FLEET
Uhlan (*Operations*)



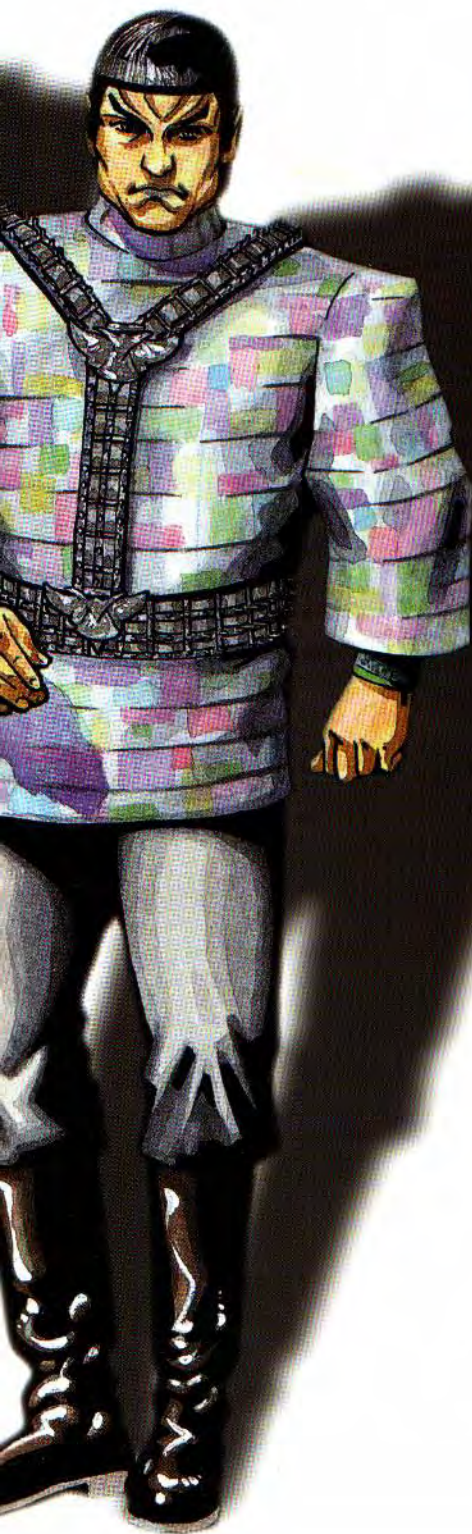

OPERATIONS
SUBLIEUTENANT

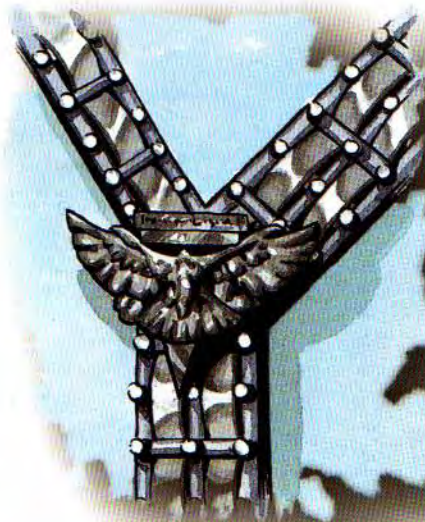

TACTICAL
SUBCOMMANDER



COMMAND
CENTURION





KASSUS FLEET
(Command)



TULAN FLEET
(Command)



COMMAND FLEET
(Tactical)

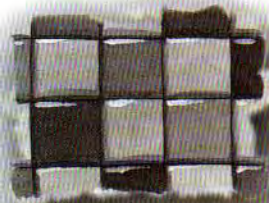

COMMAND

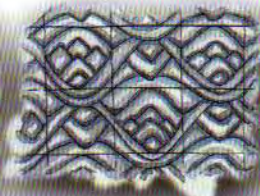

PRAETORIAN



KASSUS

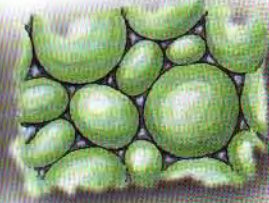

TULAN



OTHAN



STAR NAVY



TAL SHIAR

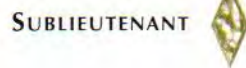

SUBLIEUTENANT



LIEUTENANT

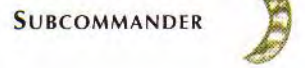

SUBCOMMANDER



**UNIFORM ADORNMENTS
(BY FLEET)**

OPERATIONS



TACTICAL



COMMAND

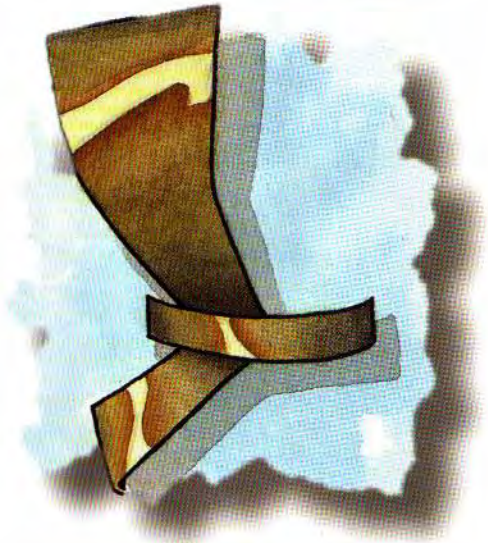

COMMANDER



CENTURION



ADMIRAL



TAL SHIAR GENERAL

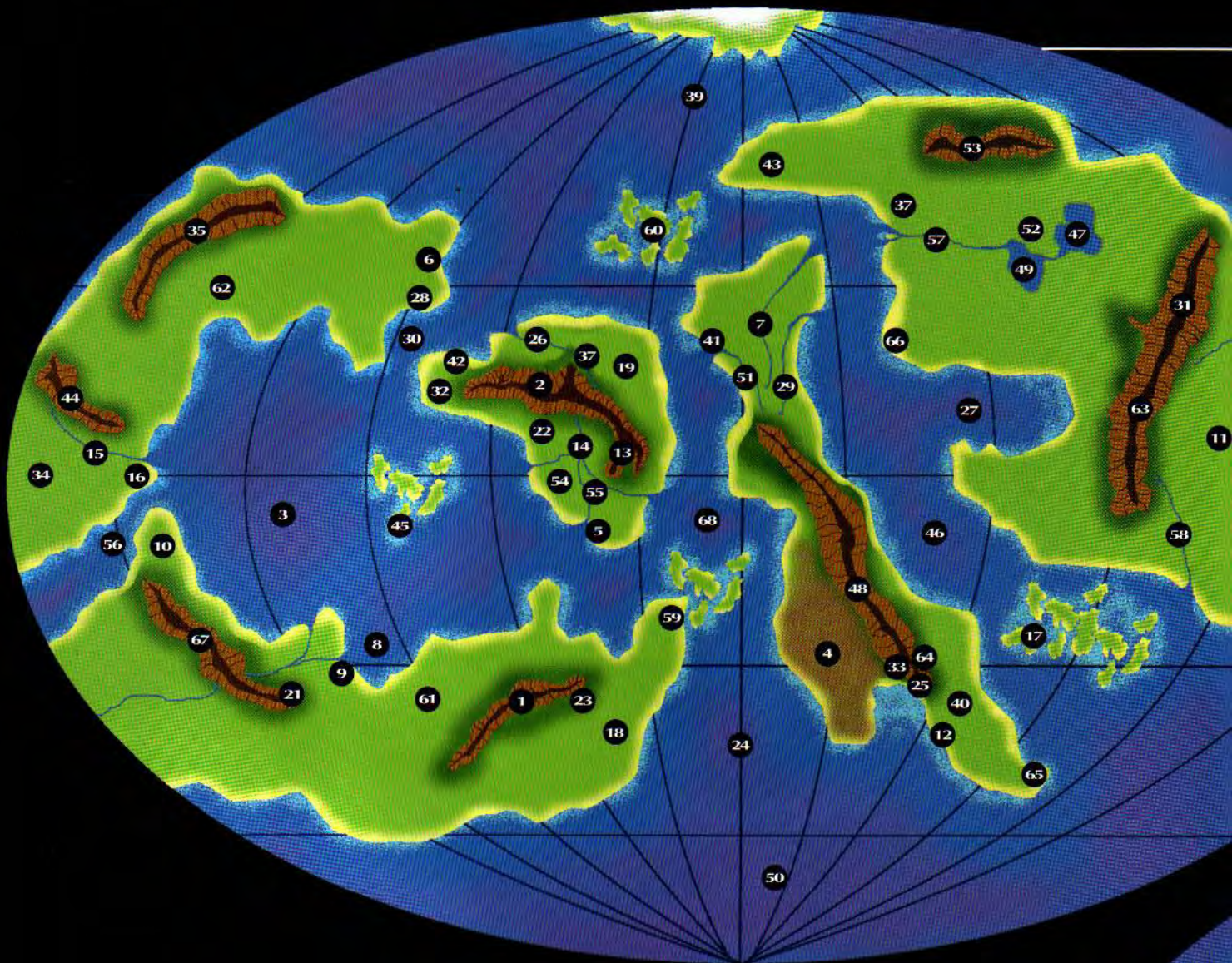

RE MUS

| | | | |
|---------------------|----|-----------------------|----|
| Andrack Ocean | 1 | Salaya | 27 |
| <i>Astrakoth</i> | 2 | Sentravean Sea | 28 |
| Balstara | 3 | South Goreb Sea | 29 |
| Baltaric Islands | 4 | Strellad Gorge | 30 |
| Belshar | 5 | Tansarr Subcontinent | 31 |
| Cham'rea | 6 | Tas'Taree Mtns. | 32 |
| Dalerok Battlefield | 7 | Thalek'Kar Mtns. | 33 |
| Dannerif Range | 8 | Tiama River | 34 |
| Ebrost | 9 | Tiama Valley | 35 |
| Ghestara Mtns. | 10 | Torek'Tan Mtns. | 36 |
| <i>Goreb</i> | 11 | Torm'reth | 37 |
| Great Dismal Swamp | 12 | Travenkha | 38 |
| Guthara | 13 | <i>Valis'Shar</i> | 39 |
| Jhal'Kerak Mtns. | 14 | Valstorean Mtns. | 40 |
| Kathlar Trel | 15 | Vedrel River | 41 |
| <i>Kel'var</i> | 16 | Vultric Peninsula | 42 |
| Korex River | 17 | Zandranek Archipelago | 43 |
| Kor'Ren Ocean | 18 | Zelva'tresht | 44 |
| Leras'nev | 19 | Zetrose Shar'n | 45 |
| Matarek Peninsula | 20 | | |
| Meraka Trel | 21 | | |
| Mount Alashk'Tar | 22 | | |
| Nech'a River | 23 | | |
| Penvar | 24 | | |
| Polar Sea | 25 | | |
| Qallasa River | 26 | | |

ROMULUS

| | | | | | |
|--------------------------|----|----------------------|----|------------------------|----|
| Allerash Mtns. | 1 | Gend'eroth River | 26 | Tai'eld River | 51 |
| Anverok Mtns. | 2 | Havrelar Sea | 27 | Tallesreld | 52 |
| Apnex Sea | 3 | Hlarek | 28 | T'aresh Mtns. | 53 |
| Ar'hael Desert | 4 | H'relgath River | 29 | Tel'Garch Subcontinent | 54 |
| Atremon Trel | 5 | Jendranax Strait | 30 | Tephren | 55 |
| Avretrel | 6 | Kae'raktar Mtns. | 31 | Terelix Straits | 56 |
| Balsanra River | 7 | Keldrak Peninsula | 32 | Thal'Tharin River | 57 |
| Bareldak Bay | 8 | Kor'Marel | 33 | Tor'ren River | 58 |
| Bareldak Trel | 9 | Kromtar Trel | 34 | Torven | 59 |
| Beld'Rath Peninsula | 10 | Ladrosch Mtns. | 35 | Uulmar Islands | 60 |
| <i>Brel'Kar</i> | 11 | Mirek | 36 | <i>Umrika</i> | 61 |
| Ch'eren | 12 | Namreshand | 37 | <i>Valcaria</i> | 62 |
| Des'Reval Mtns. | 13 | Nelrek Ocean | 38 | Valley of Chula | 63 |
| D'Gansar River | 14 | North Mendlanar Sea | 39 | Vandrok | 64 |
| Dorvek River | 15 | <i>Novok</i> | 40 | Varald | 65 |
| Dorvek | 16 | Omrashar | 41 | Val'danadex Trel | 66 |
| D'vrex Archipelago | 17 | Peldrad | 42 | Wall of Fire Mtns. | 67 |
| East Umrika | 18 | Peld'rath Peninsula | 43 | White Sea | 68 |
| Fal'seras | 19 | Raas'trek Mtns. | 44 | | |
| Fel'voth | 20 | Sath'har Archipelago | 45 | | |
| Firefalls of Gal'Gathong | 21 | Sea of Lerodan | 46 | | |
| <i>Follos</i> | 22 | Sea of Vrecess | 47 | | |
| Forest of Ath'reshaar | 23 | Sen'lanarc Mtns. | 48 | | |
| Garenak Sea | 24 | Sherelak Sea | 49 | | |
| Gav'ros Trel | 25 | South Mendlanar Sea | 50 | | |

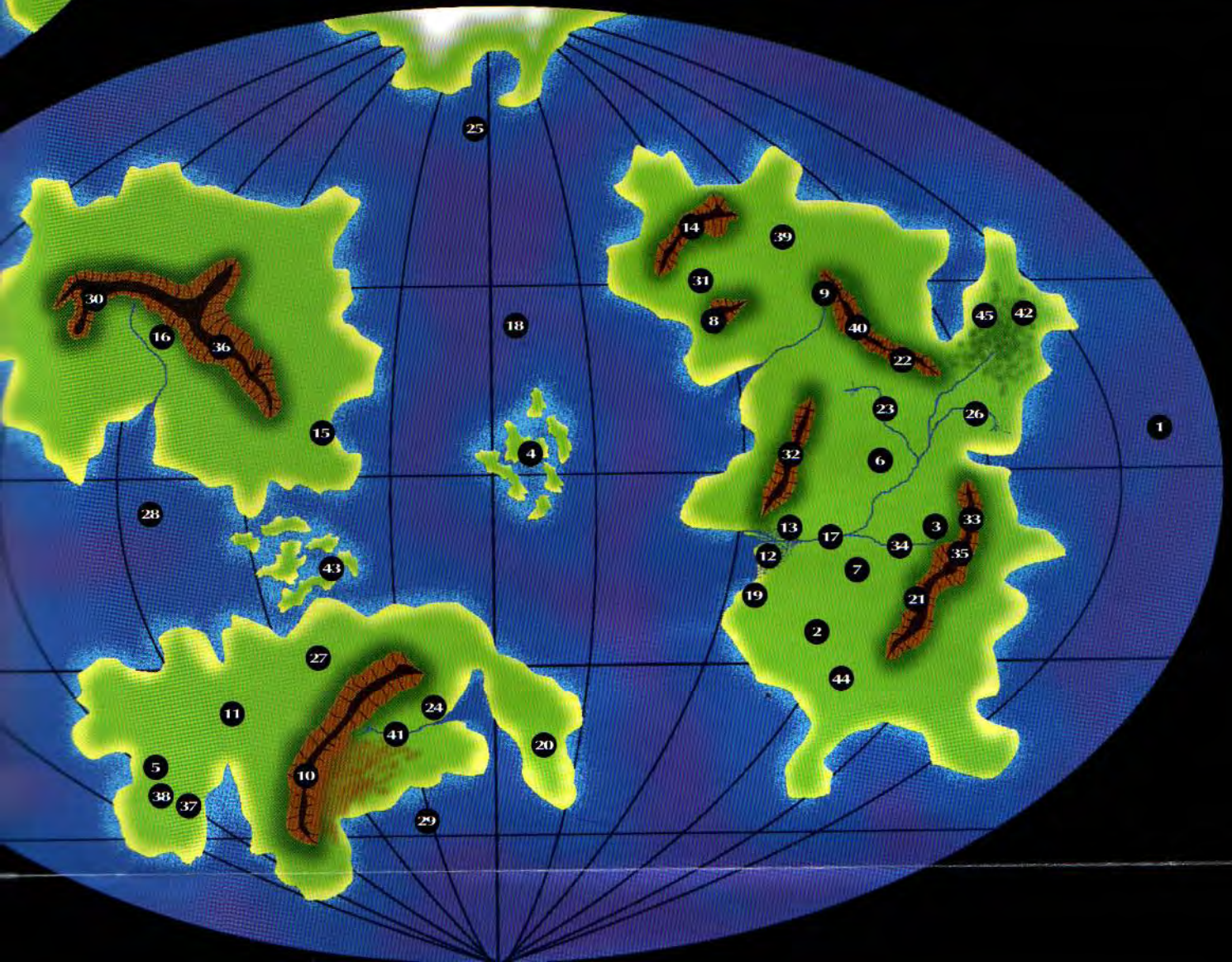
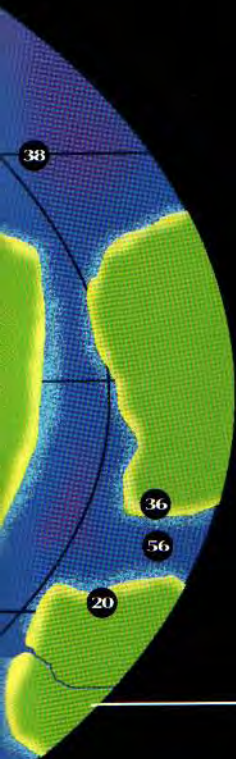

| | |
|-------------------|----|
| Kor'ken Secan | 18 |
| Leras'nev | 19 |
| Matarek Peninsula | 20 |
| Meraka Trel | 21 |
| Mount Alashk'Tar | 22 |
| Nech'a River | 23 |
| Penvar | 24 |
| Polar Sea | 25 |
| Qallasa River | 26 |

| | |
|----------------|----|
| Zetrose Shar'n | 45 |
|----------------|----|

VAL'DANADDEX TREL

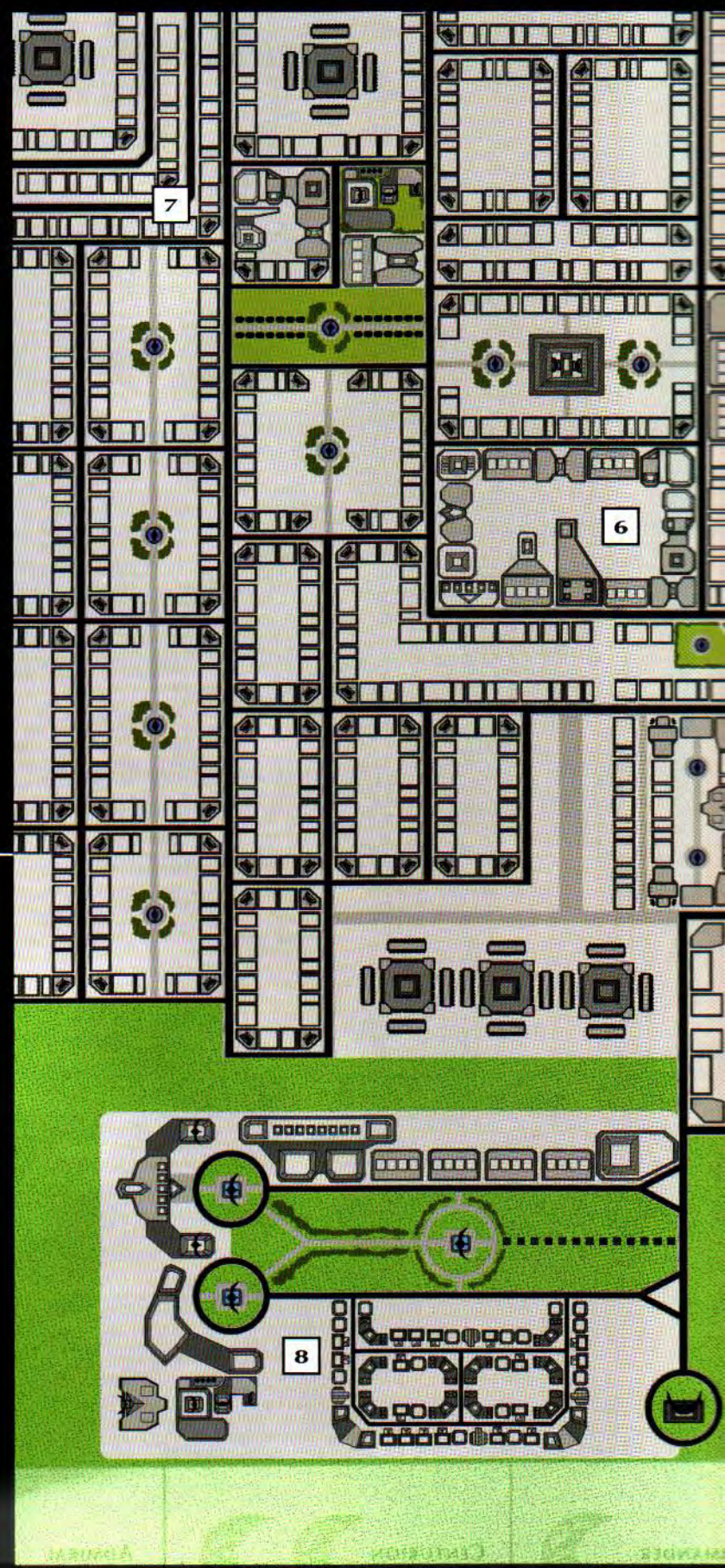

| | |
|---------------------------|----|
| Boulevard of Heroes | 1 |
| Citadel Var'Theldun | 2 |
| Garden District | 3 |
| Havrelar Sea | 4 |
| Hill Quarter (Wealthy) | 5 |
| Market District | 6 |
| New City | 7 |
| Old City | 8 |
| Plaza of the Endless Sky | 9 |
| Praetorian Guard Complex | 10 |
| Praetor's Palace | 11 |
| Romulan Senate | 12 |
| Star Command Headquarters | 13 |

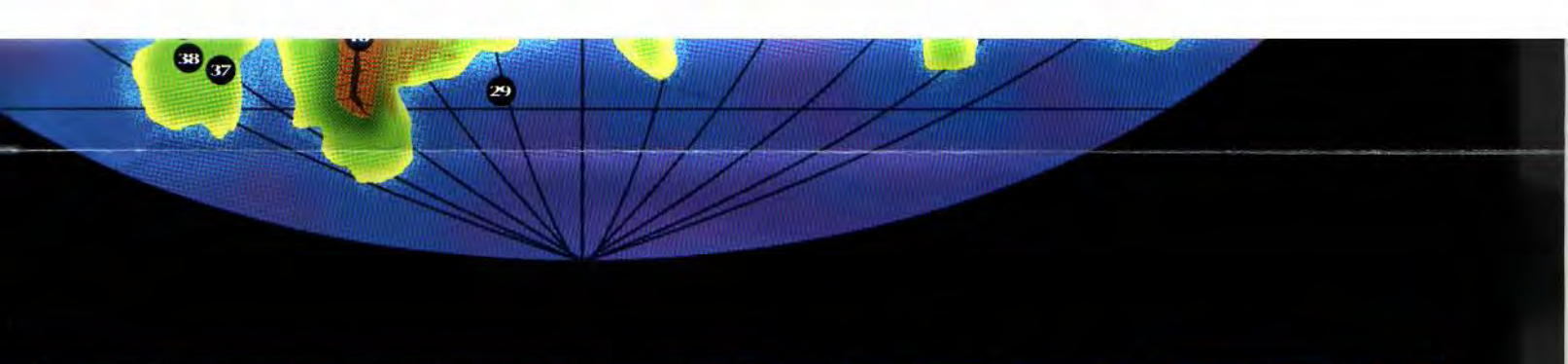
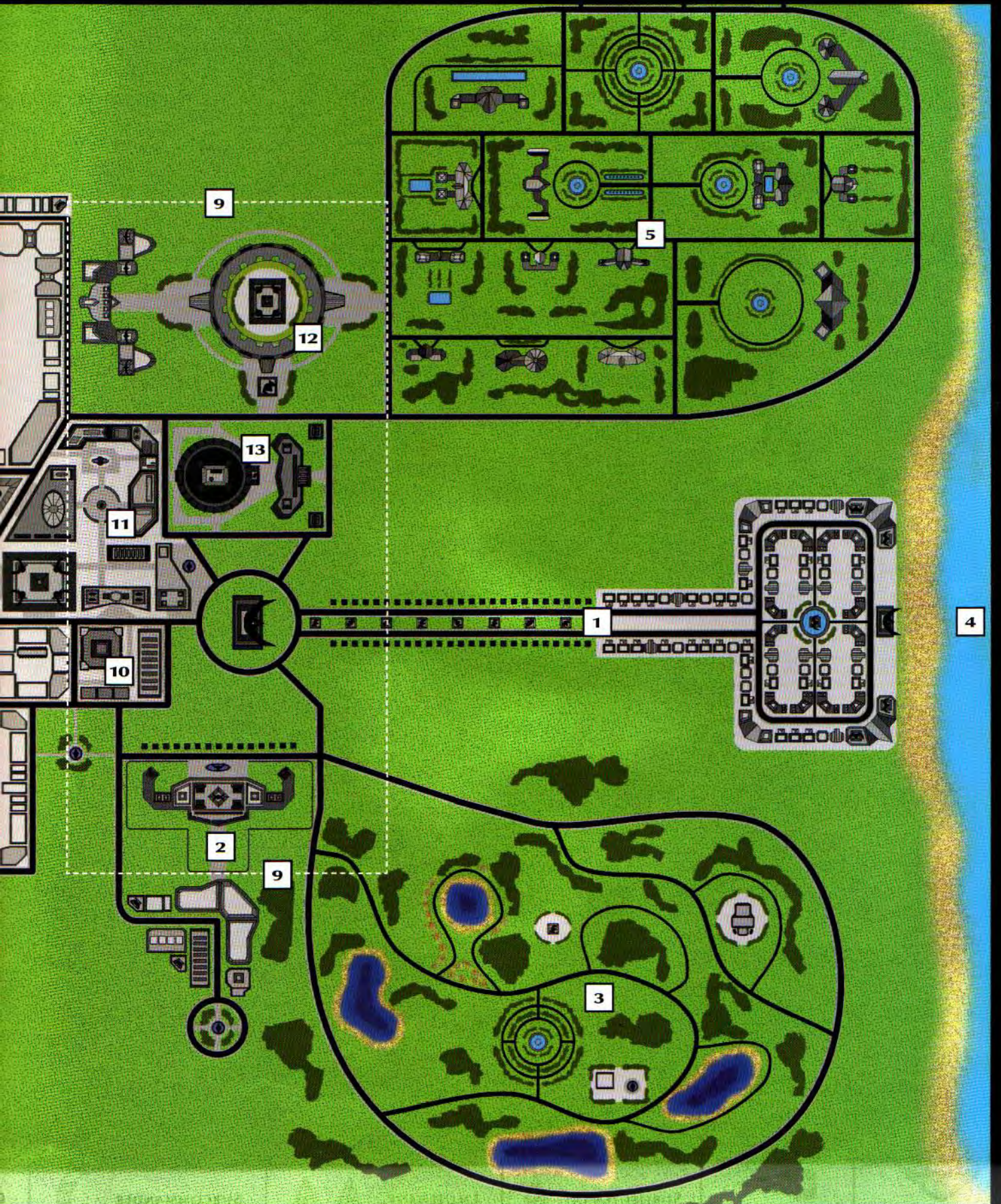

STAR TREK
THE NEXT GENERATION®

The
ROMULANS



BOOK 1

T H E W A Y O F D ' E R A

The Romulans

T H E R O M U L A N S T A R E M P I R E



B O O K 1.

AUTHORS: JAMES ESTES, ROSS A. ISAACS, EVAN JAMISON, STEVE KENSON, STEVE LONG, RICHARD MEYER, CHRISTIAN MOORE, PETER SCHWEIGHOFER

DEVELOPMENT: KENNETH HITE, ROSS ISAACS, CHRISTIAN MOORE

EDITING: JANICE SELLERS

STAR TREK: THE NEXT GENERATION® LINE DEVELOPER: ROSS A. ISAACS

GRAPHIC DESIGN: ANTHONY VAYOS

ART DIRECTION: RYAN MOORE, ANTHONY VAYOS

ORIGINAL ART: JOE CORRONEY, BARRY DOYLE, MARK FORRER, JOHN GRIGNI, PIA GUERRA, TERRY PALLOT, CRAIG SKAGGS

MAPS & CARTOGRAPHY: CHARLES RYAN, BARRY DOYLE

LAYOUT: ALVARO RIET

PRODUCT DEVELOPMENT, PARAMOUNT: PAUL RUDITIS

PROOFREADING AND FACT CHECKING: BILL MAXWELL

SPECIAL THANKS: TO MARK LENARD, FOR BEING THE FIRST. TO JOANNE LINVILLE, FOR EASILY BEING THE MOST MEMORABLE. TO ANDREAS KATSULAS, FOR REDEFINING THE ROLE. AND TO KENNETH HITE, FOR DESTROYING HIS SHIP RATHER THAN SURRENDERING.

DEDICATION: WE, THE PROUD HEIRS OF THE EMPIRE, DEDICATE THIS PRODUCT TO D.C. FONTANA AND PAUL SCHNEIDER. IN THE PRAETOR'S NAME.

DISCLAIMER: WHILE LAST UNICORN GAMES HAS RESEARCHED EXTENSIVELY TO MAKE THIS THE MOST AUTHENTIC *STAR TREK: THE NEXT GENERATION* ROLEPLAYING GAME POSSIBLE, THE DEPTH OF INFORMATION NECESSARY FOR A FULLY-REALIZED ROLEPLAYING GAME IS NOT ALWAYS REVEALED DURING A WEEKLY TELEVISION SHOW. WHILE WE HAVE TRIED TO EXTRAPOLATE LOGICALLY WITHIN THE FLAVOR OF *ST: TNG*, SOME LIBERTIES HAVE BEEN TAKEN AND PLAYERS SHOULD REMEMBER THAT ONLY THE EVENTS, CHARACTERS AND PLACES THAT APPEAR ON THE SHOW OR IN FILMS ARE CANON.

LAST UNICORN GAMES
9520 JEFFERSON BLVD., SUITE C
CULVER CITY, CA 90232
WWW.LASTUNICORNGAMES.COM

FIRST PRINTING — APRIL 1999
PRINTED IN CANADA



STAR TREK
THE NEXT GENERATION®
ROLEPLAYING GAME



Distributed to the book trade by Simon & Schuster, 1230 Avenue of the Americas, New York, NY 10020
STAR TREK™, ® & ©1999 Paramount Pictures. All Rights Reserved. STAR TREK and Related Marks are Trademarks of Paramount Pictures. Last Unicorn Games, Inc. Authorized User.
©1999 Last Unicorn Games.



TABLE OF CONTENTS

| | |
|-------------------------------|-----|
| INTRODUCTION | 5 |
| THE ROMULANS | 9 |
| THE CONSCIENCE OF THE EMPIRE | 23 |
| THE RAPTOR'S TALON | 37 |
| THE DEFENDERS OF <i>D'ERA</i> | 51 |
| THE TOOLS OF CONQUEST | 59 |
| BIRDS OF PREY | 71 |
| THE ROMULAN DOMAIN | 83 |
| WORLDS OF THE EMPIRE | 99 |
| ROMULUS | 109 |
| REMUS | 119 |



VAL SENNA

T'VIR EN

DIREN. VEN

SIR'AT DARA

VINEN.

—*TELLUS*

INTRODUCTION



"Glorious," the commander said, with an air of smug appreciation. "Simply glorious."

Piras, Centurion of the Kormorex, regarded the main viewscreen with a similar appreciation. There, in front of him, drifted the U.S.S. Invincible, bleeding plasma from its port side, arcing energy from the stump of its destroyed port nacelle. Invincible indeed, he thought. He shared the commander's enthusiasm and pride.

"The new singularity torpedoes work flawlessly," the commander said proudly.

"Indeed," Piras replied. "Now, we go home."

"Home?" Commander Meth asked. Piras detected the hint of disappointment in his first officer's voice.

"The Federation ship undoubtedly sent a distress call to whatever ships may be in the area," Piras explained. "There are likely several starships converging on these coordinates even as we speak."

"All the more reason to destroy the ship," Varok, the ship's Legate, countered. While Meth spoke from enthusiasm, and an earnest desire to serve the Praetor, something Piras could appreciate, the scheming Legate had his own, ulterior motives.

Piras suspected he would file a report as soon as they returned to Romulan space. Although not as ruthless as the Tal Shiar, officers of the Tal Diann often got ahead by second-guessing their commanding officers. Varok would characterize the encounter as cowardice, or dereliction of duty. Yet Piras did not fear retribution. He had friends in both the Star Command and the Senate.

Commander Meth took up the cause next. "Centurion, we are cloaked. We have suffered minimal damage. And we have the Empire's newest weapon. In the name of D'era, we should finish off the Praetor's enemies." Piras could see the others on the bridge being swayed by the argument. He found himself agreeing inwardly. But there were larger issues to be considered and higher orders to be followed.

"The Empire's newest weapon means little if none survive to tell of it. The starship will make a full report of the encounter," he said, satisfied, "and the Federation will fear the singularity torpedo." Commander Meth stood there, mute. He knew better than to continue challenging his commanding officer.

"Set a course for our side of the Neutral Zone," the Centurion ordered. The bridge crew responded with quiet efficiency. And once inside the Neutral Zone, he continued his thought, we'll let down our cloak and allow the starships to detect us. They'll violate the treaty to come after us. Then we'll spring our trap—a wing of warbirds, all armed with singularity torpedoes. The Kormorex had to be ready for the coming fight, had no time to tarry with crippled starships. The Star Command's orders had been explicit.

Suddenly, the Kormorex shook with the impact of a weapon. The crew swung into action. "Photon torpedo damage, decks 12 and 14. It's the Invincible!" Tactical reported. "Somehow they've found us!"

"Not as crippled as we thought," Piras muttered, impressed not only by the inventiveness of his opponent, but by the audacity. He pushed aside questions of how the starship had pierced the cloaking device. A new game was afoot. "Tactical, arm torpedoes. It looks as though we will have to destroy the Invincible"

The Way Of D'era

Their warbirds slip invisibly through space, striking like a bird of prey swooping down on an unsuspecting mouse—swiftly, suddenly, surely. Their spies—tenacious, capable—infiltrate the most sensitive areas, turning up in the most surprising places. Like master chess players, they think dozens of moves ahead, move their pieces in combination, and send out their pawns to test the skill of their opponents. They are the Romulans—perhaps the most dangerous, and certainly the most insidious, threat to Federation security.

According to Romulan mythology, the Vhorani created the Vulcan/Romulan species at *Vorta Vor* and charged their children with a mighty task: one day to rule over the stars. They set their children on a fiery, desolate world, with few of the elements necessary for life, to teach them an important lesson—the survival of the fittest. These ancient ancestors fought many battles over land, food, and water. Natural selection winnowed out the weak, and the strong survived.

Thus were the children of the Vhorani fashioned in the heat of the Vulcan forge. When the ancient Vulcans turned their backs on their legacy, embraced a false philosophy, and quenched the fire that burned in their hearts, those who understood their destiny fled to the stars. These future Romulans could no longer remain on Vulcan, the world of their testing, and instead ventured into the Endless Sky.

In many ways, the Romulans are the mirror image of their Vulcan cousins. The Romulan heart still burns with the fire of their ancient Vulcan forebears. Where the Vulcans are emotionless, the Romulans embrace passion. Where the Vulcans are peaceful, the Romulans pursue war. While the Vulcans allow logic to be their guide, the Romulans follow their hearts. Vulcans cherish the infinite diversity found in infinite combinations throughout the universe. For Romulans, there can be only one way—their way, the Way of *D'era*.

From their humble beginnings on a new planet, the Romulans forged an empire through conquest and domination. Remus, twin to the home planet of Romulus, was the first in a long line of planets to fall to Romulan aggression. As humanity ventured beyond its solar system, expanding across a new frontier, it was the Romulans who presented Earth with its first interstellar challenge. In this, their first war, with Earth, the Romulans may have been beaten, but they were not defeated. They retreated behind their Neutral Zone, turned their attention elsewhere, and bided their time.

Over and over, they would return to test their neighbors—the Klingons, Taurhai, and Federation—probing for weakness, challenging their resolve. For if a people refuse to accept Romulan rulership, they must be made to see the error of their ways. For Romulans, each opponent presents a new challenge, calling them on to greater effort, and reminding them of their charge—one day to rule the Endless Sky.

INTRODUCTION

The Way of D'era includes an abundance of information to enhance any *Star Trek: The Next Generation* RPG series. As implacable foes, the Romulans can challenge any Starfleet crew. Face off against the com-

mander of a Romulan warbird in a daring cat-and-mouse game along the Neutral Zone; pursue ruthless *Tal Shiar* agents who seek to bring down the Federation from within; or perhaps come to an agreement with these noble aliens, in true *Star Trek* fashion. Set your series in Romulan space, and explore the *Star Trek* milieu from their point of view. Take command of a *D'deridex*-class warbird, pushing the boundaries of Romulans space and adding new worlds to the Empire; chase down traitors to the Empire on the streets of Val'danadex Trel; or struggle for reunification with your Vulcan relatives, and perhaps bring peace to the Romulan Empire.

WHAT'S IN THIS PRODUCT?

From the magnificent capital of Val'danadex Trel to client worlds on the fringes of Romulan space, from the feared *Tal Shiar* to the distinguished legislators of the Romulan Senate, *The Way of D'era* provides perhaps the most comprehensive information currently available on this mysterious, yet noble people.

BOOK ONE: THE ROMULANS

CHAPTER ONE: THE ROMULANS

The Romulans provides an overview of Romulan history, physiology, and culture, and answers burning questions like: Do Romulans feel the blood stirring of *pon farr*? Can they mind meld? How did they evolve from a band of wanderers into a mighty empire?

CHAPTER TWO: THE CONSCIENCE OF THE EMPIRE

The Conscience of the Empire details the Romulan government. While every politician, from lowly bureaucrats to powerful senators, serves the interests of the Empire, the Romulan government can be a hotbed of plots and counterplots.

CHAPTER THREE: THE RAPTOR'S TALON

The Raptor's Talon details the organization of the Romulan military. While most outsiders see the Romulan Star Navy as a unified organization, many senators retain control of their own fleets, adding a new dimension to political battles. This chapter details the Star Navy and its branches.

CHAPTER FOUR: THE DEFENDERS OF D'ERA

The Defenders of D'era covers the secretive security force of the Romulan Empire, feared by Romulan and Federation citizen alike—the *Tal Shiar*. Their far-reaching powers, single-minded determination, and skill at deception make them impressive comrades, and formidable foes.

CHAPTER FIVE: THE TOOLS OF CONQUEST

The Tools of Conquest details the devices and technology employed by the Empire. Although the Romulans use tricorders and PADD's, their technology differs significantly from that of the Federation.



CHAPTER SIX: BIRDS OF PREY

Birds of Prey provides information on Romulan starships. While the *D'deridex*-class warbird is the ship most identified with the Romulans, the Empire employs a variety of vessels—from small *Theta*-class couriers to gigantic *Vereleus*-class dreadnoughts. This chapter provides details on several new Romulan starship classes and ship types.

CHAPTER SEVEN: THE ROMULAN DOMAIN

The Romulan Domain covers the vastness of the Romulan Empire, describing key sectors within their space. Find out what lies on the other side of the Empire, including a detailed treatment of the Taurhai Unity, the aliens who occupy the Romulans as much as the Federation does.

CHAPTER EIGHT: WORLDS OF THE EMPIRE

Worlds of the Empire describes the many planets that fall within the Romulan sphere of influence. From long-time Romulan colonies to planets and peoples absorbed by the Empire—the Romulan Empire contains as much adventure as Federation space.

CHAPTER NINE: ROMULUS

Romulus provides a detailed overview of the home planet of the Romulan people and seat of their mighty Empire. From the Firefalls of Gal'Gathong to the shores of the Apnex Sea, there is much to see and do on the Romulan homeworld.

CHAPTER TEN: REMUS

Romulus is not the only world dear to the Romulan heart. *Remus* details the planet often mentioned in the same breath as the Romulan homeworld. Find out what lies on this, the center of the Romulan military effort.

BOOK TWO: ROMULAN CHARACTERS

CHAPTER ONE: CHARACTER CREATION

Character Creation provides the reader with the information needed to create Romulan characters. Play an up-and-coming subcommander in the Romulan Star Navy, a subtle and cunning agent in the *Tal Shiar*, an official in the Romulan government, or a member of the Vulcan Reunification Movement.

CHAPTER TWO: SKILLS AND TRAITS

Skills and Traits provides new Skills, Advantages, and Disadvantages, as well as updates of some old ones with a Romulan twist.

CHAPTER THREE: SCIONS OF THE EMPIRE

Scions of the Empire details some of the most important people in Romulan space. Become one of the Praetor's entourage, go on an assignment for Senator Kassus, or confront the likes of Commander Tomalak or Sela.

CHAPTER FOUR: ROMULAN SERIES

Romulan Series provides Narrators with guidelines for including Romulans in the average Starfleet campaign, and for crafting episodes set in Romulan space. Also included are rules pertaining specifically to Romulans with which the Narrator should be familiar. Create and play entire series with Romulan characters set in the Star Empire.

BOOK THREE: ROMULAN ADVENTURES

ADVENTURE 1: THE GENTARA INCIDENT

On the Romulan protectorate of Gentara, the native inhabitants chafe at the yoke of Romulan dominion and secretly plot rebellion. The situation attracts the attention of a powerful Romulan Senator in a complex and subtle game of political chess, with Gentara as the board. Can the Crew of a Romulan warbird stop the rebellion, and uncover the web of intrigue that lies just below the surface? Or are they merely pawns in a much larger game?

ADVENTURE 2: DUTY OR CONSCIENCE

The Federation has long abided by the Prime Directive, the law preventing interference with primitive cultures, although many have grappled philosophically with the ramifications. A simple investigation on a small mining colony leads to a much greater moral dilemma for a Crew of Starfleet officers. The ramifications have far-reaching effects—all the way into Romulan space.



MAPS

The Way of D'era includes four maps on two double-sided poster sheets. The first map shows the majority of Romulan space, pinpointing the sectors and planets detailed both in this product and others published by Last Unicorn Games.

The second map reveals the topography of Val'danadex Trel, the capital city of the mighty Romulan Empire. The Romulan and Reman homeworlds comprise the third and fourth maps. Finally, the last sheet provides a convenient recognition chart showing a selection of Romulan vessels and Star Navy uniforms in current use.

HOW TO USE THE WAY OF D'ERA

Using the material presented in *The Way of D'era: The Romulan Star Empire*, both players and Narrators can enhance any already existing *Star Trek: The Next Generation RPG* series. The material on Romulan culture, politics, the *Tal Shiar*, and the like is meant to spark ideas and foster stories. Why did the Romulans attack this world? How does a political battle in the Senate lead to increased tensions along the Neutral Zone? What would the Romulans do if they learned of a working Iconian gateway, or a new form of warp drive being developed by Starfleet?

Although the answers to these questions can be simple, with the material presented herein Narrators and players can lend their Romulan antagonists and



characters a deeper motivation than that of simply opposing the Federation. With a fuller understanding of Romulan culture and society, you can add subtle nuances that turn a fairly routine episode into something richer. The material presented in these books will allow you to play entire Romulan series set in and around Romulan space.

The Romulans do not see themselves as villains conquering worlds for the sake of conquest, but rather as a people with an admirable way of life—one worthy of expansion. To them, other species—humans, Cardassians, and Klingons—are the villains, for they do not acknowledge the rightness of Romulan culture, and do not submit to Romulan domain. Yet not every Romulan would agree with a particular course of action; there are as many interpretations of *D'era* as there are Romulans. In the classic *Star Trek* tradition, in time, perhaps, Starfleet player characters may come to understand what drives the Romulans, and through understanding reach peace.

But *The Way of D'era* really comes into its own when used as a setting for a *Star Trek: The Next Generation RPG* series. Players can explore the Romulan perspective by playing the role of a stalwart Romulan soldier, an ingenious *Tal Shiar* agent, or a progressive member of the Vulcan Reunification Movement. Become embroiled in political intrigue between powerful Senators. Safeguard the Empire from disloyal citizens who would destroy the Romulan way of life. Explore new worlds and bring them under the Imperial banner. Or work from within to reunite the Romulans with their Vulcan cousins. This product provides Narrators with plenty of information to take their series beyond the Neutral Zone and deep into the heart of the Romulan Empire.

CUSTOMIZING THE ROMULAN BOXED SET

While this product attempts to present all the information on Romulans covered by the television shows and movies, and provide the reader with the back-

ground information necessary for a roleplaying game, the Romulans are a complex, vibrant people, requiring volumes to cover, not pages. Narrators should consider the information presented in *The Way of D'era* as guidelines rather than hard-and-fast rules.

One of the most enjoyable aspects of being a Narrator comes when creating your own material. You get to exercise your own creative vision and make the setting your own. Something contained herein might not suit your storytelling needs, or you might want to add your own ideas to the mix. You may want to add a region of space, one unclaimed by the Federation and the Romulans, fraught with intrigue and brinkmanship. Add it. You might prefer to leave the Praetor's position unfilled, and set your series against the backdrop of a succession battle. Change it. As the television shows and movies reveal more information about the Romulan Empire, Narrators will want to include this material. We encourage you to expand on the information contained within, to make the Romulan Empire your own creation. Ultimately, you're the producer of your own series.

THE ICON LINK

In the *Way of D'era* we also introduce Last Unicorn's newest addition to our product line-up: the Icon Link. Inside of all our new products, you will find the icon you see floating behind this text. This icon means that you can find additional material, on the subject you're reading about, at the Last Unicorn Games website.

This material has been created to add value for our fans and players. Examples might include, expanded history facts and timelines, new templates and overlays, or new starship classes. As much as we would like to fit everything into our new products, we do have limited space, so we created the Icon Link so that you won't miss anything we have words and art for! Enjoy!

Check all of our *Way of D'era* Icon Link information at www.lastunicorngames.com.

THE ROMULANS



The most striking thing a first-time observer notes about Romulans are the similarities between Romulans and Vulcans. The first time a Starfleet officer laid eyes upon a Romulan, in the 22nd century, during an unprovoked attack on Federation starbases along the Neutral Zone, the officer wrongly assumed Vulcans and Romulans were one and the same people. Beyond the obvious physical similarities, however—notably the pointed ears, high cheekbones, and slanted eyebrows—the Federation quickly learned of substantial differences between the two Vulcanoid species. The Romulans, passionate and warlike, seemed the mirror reflection of the cold, logical Vulcans. In their physiology, culture, and history, the Romulans differ significantly from their Vulcan cousins.

Romulan Physiology

Only slight physical differences separate the Romulans from their biological cousins the Vulcans. From their heart, placed where the liver is among humans, to their green blood, Romulans and Vulcans share nearly identical biologies and chemistries. A few differences are worth noting, however—differences ascribable to the many years spent apart in distinctly different environments.

Romulans possess only a vestigial inner eyelid: They no longer live under Vulcan's bright sun, and the inner eyelid which evolved in Vulcans to protect them from their sun's harsh light has begun to deteriorate among Romulans to the point of functionlessness. A small number of Romulan infants have been born bereft of this additional lid, and Romulan geneticists surmise that within another few centuries the majority of their people will lack even the vestigial lid.

Likewise, the gravity of Vulcan—which contributed to that world's inhabitants' great strength—is different from the gravity of the Romulan homeworlds and colonies. The change in environment is noticeable and measurable: Although Romulans are somewhat stronger on average than humans, they have lost the even greater strength and endurance of their Vulcan kin.

The Romulan lifespan is still prodigious; it is not uncommon for Romulans to pass two centuries in age.

Romulan Psychology

Although Romulans and Vulcans share a common ancestry, the two peoples are psychologically worlds apart. Where the Vulcans are a stoic and logical people, the Romulans are vibrantly passionate, acting more from the heart than from intricate philosophical reasoning.

Romulans have been described as a study in contrasts: equally capable of savagery and tenderness, both passionate and emotionless. Romulans consider themselves a study in authenticity, however: They decry the belligerent posturings of Klingons, the forced placidity of Vulcans, and the bland softness of humans. Romulans understand that any day may be their last, and so they live neither controlled by emotions nor controlling them. The Romulans live their lives fully. To them, the Vulcan "Time of Awakening" was not a period of enlightenment, but a time when their Vulcan ancestors cut themselves off from a vital way of experiencing and interacting with reality. The Romulans call this "The Renunciation."

The Romulans have historically been a violent species. They are a warrior culture, and martial conquest is prized and honored. Where the

Vulcans turned away from war, as they turned away from emotion, the proto-Romulans continued to embrace violence as a means to an end. "We are warriors," they argued. "Why deny our very nature?" When the followers of Tellus fled Vulcan, they retained their warrior natures, but moved away from the internal strife that characterized Vulcan antiquity and toward military conquest.

D'ERA: A PSYCHOLOGICAL URGE

It was in response to Surak's message of peace through emotionless logic that the philosophy of *D'era*, the "Endless Sky," developed. A Vulcan known as Tellus spread his own message, justifying Vulcan's bloodthirsty history. His epic poem, *The Way of D'era*, drew upon obscure myths, describing how an ancient species called the Vhorani created the Vulcan people at *Vorta Vor*, the Wellspring of Creation. The Vhorani deposited their children on the Vulcan homeworld, Tellus reasoned, because of its severe environment, to temper the Vulcans through adversity and war.

According to *D'era*, as the heirs to the Vhorani, the Vulcans were destined to be the caretakers of the universe. Only through constant struggle, Tellus taught, could the Vulcan people become strong enough to accept the Vhorani mantle. To accept Surak's message was to abandon their birthright as caretakers of the universe. As the Children of the Vhorani, it was their right to rule the weaker species, and their manifest destiny to rule the stars. Although Tellus' *Way of D'era* attracted some followers, Surak's teachings captured the Vulcan mind. In the end, Tellus' followers fled the Vulcan homeworld to fulfill their sacred mandate.

To this day, *D'era* dominates the Romulan psyche. By embracing their passionate, warlike natures, Romulans believe they keep the true legacy of the Vhorani alive. *D'era* defines their history and their worldview. All other peoples are ultimately inferior to Romulans, and this belief fuels Romulan smugness and arrogance in dealing with outsiders. But *D'era* remains more than simply manifest destiny: It is a calling to a unified purpose that transcends individual limitations or agendas. It is obedience to a higher cause, and it is an obedience that gives the

Romulans the discipline that keeps them from tearing each other apart. As a result, the Romulans developed a shared tendency toward loyalty, obedience, and discipline in the name of a higher power—be it the government or the military or the cosmic mandate of *D'era* itself.

Thus it is easy for the Romulan leaders to demand loyalty and obedience: The Romulans do not deliver it out of fear but rather out of their own desire to fulfill Romulan destiny, or their own inborn need to be loyal and obedient. Romulans lead and follow with almost equal relish, secure in the knowledge that they adhere to *D'era*, and only rarely defy an order.

Likewise, framed through *D'era*, honor has a different meaning for the Romulans. Honor is not superficial integrity or warrior bravado: It is a reflection of Romulan accomplishment, on the personal, familial, and imperial levels. A family with a strong history of service and meritorious actions in the Praetor's name is a family of great honor. The Romulans have been called a people of strict moral compass, yet at the same time their opponents charge them with terrorism, espionage, and treaty violation. To the Romulans, these are all allowable actions within their strict code of ethics, which centers on the expansion of the Empire.

THE PATH OF D'ERA

According to legend, when Tellus was asked during the great exodus, "What is a Romulan?", he delivered the four Virtues of the Way as his apocryphal response. While many scholars, philosophers, and historians have analyzed and studied his words over the centuries, his expression remains a remarkable and elegant distillation of the fundamental precepts which embody *D'era*.

The virtues espoused by Tellus also reflect the Romulan belief in their own manifest destiny as a people. Believing themselves to be the heirs of the Vhorani, their philosophy of life carries with it a certainty normally reserved for a "chosen people." To the Romulan mind, Humans are weakened by their compassion; the Vulcans strayed from their heritage long ago; the Ferengi are little more than laughable upstarts; the Klingons remain slaves to their ridiculous honor—only the Romulans carry the pure flame of their Vhorani forebears. In their never-end-





ing search for *Vorta Vor*, they have come to embrace their destiny as a people: to walk in the footsteps of their immortal scions and follow the sacred Way as they continue their glorious expansion throughout the galaxy.

Known to every Romulan since youth, the four virtues are: Devotion, Allegiance, Discipline, and Fidelity. Most Romulans consider these to be the legacy of Tellus; they are the guides he left behind to aid Romulans on their long journey along the sacred Way.

DEVOTION

Largely a family virtue, Devotion implies loyalty to the family; the inherent authority this represents gives strength and unity to the family, an important concept in an Empire where family ties and genealogies often date back to before the founding. In a larger sense, Devotion connotes loyalty to state and Empire, a willingness to obey the law, serve faithfully, and practice patriotism consistent with justice. Many Romulan poets and artists consider Devotion to be the foundation upon which *D'era* rests.

ALLEGIANCE

The basis for all imperial justice, Allegiance assumes a unique role in the larger culture of the Empire. It connotes truth in all of its various guises—in the payment of debts, the keeping of one's sworn oaths, the performance of duties entered into through contracts. Deeply based in religion, philosophy, and law, Allegiance serves as the foundation for much of Romulan public and private life. Breaking a sworn allegiance is considered a violation not only of another's rights, but a violation against Romulan society itself. Often stronger than written law, Allegiance is the bond which unites all elements of Romulan society, no matter how small or insignificant they may be.

DISCIPLINE

A supplement to Allegiance, Discipline represents absolute self-control and self-possession, a dignified and unconcerned attitude toward both good luck and ill fortune. Sometimes confused with certain schools of Vulcan logic, it differs from these philosophies in that it connotes

the concept of emotional choice, not the repression of the same. According to Romulan philosophy, an individual makes his own destiny; he doesn't simply find it. For this reason, the concept of luck remains an alien notion to most Romulans; luck becomes a function of consequences, of the results of one's own actions.

FIDELITY

Another component to Allegiance in the minds of most Romulans, the concept of Fidelity is most often attributed to Tellus himself; representing perseverance and unswerving focus even under the most trying circumstances, this virtue guides a Romulan in his daily life. It represents doing whatever is necessary and right to win success. Many Romulans feel that the Star Empire itself embodies the greatest expression of this virtue—in a long and often dark history, the will of the Romulan people has never broken.

By diligently following these virtues, a Romulan acquires dignity (reputation, esteem, and honor) and authority (respect and the prestige necessary to be a true leader). These qualities are highly prized, since they serve to confirm a Romulan public or military figure's leading role in society. Those who serve the empire well, performing their duties faithfully and with honor, gain the prestige (and therefore the power) necessary to allow them to continue to lead their people. This power, of course, gives them the opportunity to earn even more dignity and authority, thereby enhancing their status further. Thus continues the age-old competition among the Romulan aristocracy, all in the name of furthering the imperial agenda and expanding the empire. Such questing for destiny and glory embodies the very essence of *D'era*.

THE CHEMISTRY OF EMOTION

The difference in temperament between Romulans and Vulcans has produced a number of noteworthy physiological and neuropsychological variances. Because the Romulans do not reign in their emotions—indeed, they give in to them freely—they do not suffer from Bendii syndrome, or any of the other psychoemotive afflictions of Vulcans. (The Romulans point to this factor as evi-



dence that their way, as opposed to Surak's way, is normal and healthy.) For similar reasons, perhaps (and also possibly as a result of different endocrine chemistries, themselves stemming from different planetary biochemistries), Romulans no longer engage in *pon farr*.

ROMULANS

PSYCHIC ABILITIES

Another profound difference separates the Vulcans and Romulans: The Romulans lack Vulcan psychic abilities. Both share the same genetic predisposition for psychic traits, but as the Vulcan peoples turned inward, becoming more reflective and focused, their psychic abilities were enhanced—an opportunity not available to the Romulans.

Neither are Romulans entirely bereft of psychic talent. The predisposition remains, even if their history and culture have not catered to its development. On rare occasions, a Romulan is born with psychic abilities almost equal to those of Vulcans. Such Romulans typically demonstrate their powers around early adolescence, and the Romulan military routinely tests children for psychic powers, sending those children recognized as talented psychics to the Imperial Institute of Mental Sciences, where the psychics train to hone their powers in the service of the Romulan Star Empire.

Some Romulans manage to hide their psychic abilities, wanting to avoid being used as living weapons for their Praetor. Some even turn to Vulcan teachings, in hopes of better understanding and focusing their growing power. The *Tal Shiar* greatly fears dissidents of such subtle power, and is always on the lookout for them.

The Romulan Way

The earliest Romulans—or, more accurately, the earliest Vulcans—were war-hungry, even savage. How they attained any measure of scientific knowledge without

utterly destroying themselves remains a mystery to many people. Though the Romulans have certainly grown beyond their Vulcan ancestors' earliest, most savage days, their martial spirit has dominated Romulan culture for generations.

SCIENCE: CONQUEST'S TOOL

Romulan science is, and has always been, predicated on military might and conquest. Space exploration is pursued to further the Empire; Romulan doctors develop surgical procedures as a result of combat medicine; scientific research serves the state.

This is not to say that Romulans are not inquisitive, nor that no Romulan has ever explored uncharted space simply for the merits of exploration. But the state supports science, and the state is more pragmatic than philosophical. If experiments are not of immediate, demonstrable value to the Empire, the Senate cuts their funding in favor of other, more utilitarian studies.

The Romulan Astrophysical Academy is the highest-ranking institution of academic and scholarly pursuits in the Romulan Star Empire. Founded over a thousand years ago (as the Imperial College of Sciences), it serves as the state's research and development facility, and trains future generations of Romulan scientists. A network of other institutions coordinates studies in genetics and medicine, astroarchaeology, geology, and other disciplines, but astrophysical sciences are the mainstay of Romulan scientific endeavors: It is through this branch that *D'era* is given a scientific forum.

Located in a heavily fortified space station in orbit around Romulus, the Academy is one of the more secretive institutions in the Empire. Only individuals with the highest clearance may work for or visit the Academy, and its work is classified: Divulging experiments from the Academy constitutes an act of treason and is punishable by death. (Satellite campuses and laboratories located on Romulus itself handle instruction and more public operations.)

The Academy works closely with the military, providing the technology needed to maintain the Empire's might. Academicians constantly develop, examine, and test cloaking technologies, alternate methods of warp power, and a variety of weaponry (both ship-based and hand-held). For these reasons, the Academy is closely guarded: Federation, Klingon, and Taurhai spies would dearly love to claim some of these secrets for their own governments.

ARTS: VICTORY'S HERALD

Just as science is meant to further *D'era*, art is meant to celebrate it. Performing, visual, and literary arts all memorialize the growth of the Romulan Star Empire, from the days of the Vulcan diaspora to the settling of Romulus to the earliest conquests. The early Romulans are the heroes of the Empire, serving as models for all citizens to emulate.

The greatest of all Romulan artistic pieces is the *Tel'laa'vor*, by the poet Japell. Composed in the earliest centuries of Romulan expansion, it narrates the exploits of the founding Romulans, from Tellus' gathering of his followers to the decades-long search for Romulus, to the conquest of Romii—it is the stuff of heroes overcoming adversity and enemies and nature itself. Every Romulan child learns the story of the *Tel'laa'vor*, and it inspires a host of other artistic pieces. The Romulans treat the *Tel'laa'vor* almost as



scripture—although not considered divinely inspired, its narrative is unquestioned.

The founding of Romulus is celebrated annually, as families read from the *Tel'laa'vor* and Romulan communities sponsor theatrical presentations of *The Romul'aad*, a dramatic version of the *Tel'laa'vor*—replete with a chorus commemorating Romulan heroism and bravery and vilifying the cowardly Vulcans who abandoned their natural heritage.

Romulan visual arts triumphantly celebrate the Romulan ideal: the strong, courageous warrior who triumphs over all. Romulan statuary follows artistic conventions unchanged for centuries, demonstrating the “Romulan hero” as the paradigm of natural development: tall, muscular, and stern, depicted either in fierce battle or standing over a fallen foe—to represent that a Romulan’s greatest power is not his weapon, but himself.

Various artistic schools have, of course, developed different representational styles, and some have become quite popular, but the art seen most commonly is that sponsored by the Romulan government, which follows the traditional conventions. The government is less interested in avant garde artistry than in reminding the people of their proud heritage and their duties to *D'era*. The Imperial Academy of the Arts, located in the city of Kromtar Trel, in the southern continent of Valcaria, is the finest institution for the arts, and receives official support from the Romulan government.

Romulan architecture and city planning are highly developed arts: broad, sweeping colonnades, tall buildings, and a unified geometric design, with civic buildings at the geographic and symbolic center of every city. The city is meant as a microcosm of the Romulan Star Empire, its buildings and avenues, all immense in scale, reminding citizens of the growth of their mighty empire. Of course, cities in conquered worlds tend to maintain their original designs, but over the course of years they are slowly “Romulanized” with statuary and bas-reliefs commemorating noteworthy events in Romulan history.

RELIGION: RITES OF TRANSITION

D'era is the axis of Romulan religion, which is less concerned with personal spiritual growth than with the growth of the Romulan Empire: What benefits the Empire will benefit its citizens, and a strong and growing Empire feeds its people spiritual energy. Romulans no longer speak of Vulcan gods like *Ket-cheleb* and *D'era* as deities of a mythological pantheon, but speak of them as profound metaphysical principles which drive the Romulan peoples onward.

Romulan religion is dominated by a series of *Praxani*, or Rites of Transition, which indicate varying stages of allegiance to *D'era* and the Romulan ethos. Through these steps, the Romulan citizen reaffirms his loyalty and obedience to the Romulan Star Empire, knowing that what best serves his state likewise serves him. Similarly, the *Praxani* unite generation after generation of Romulans, acting as a social bond that keeps Romulan society united. In many ways, the beliefs of a citizen are less important than his actions: As long as the Romulan acts in accordance with *D'era*, regardless of personal preference, then society is maintained. The rites described below are only a few examples of the rituals conducted in Romulan society. A society as rich in tradition as the Romulan maintains many rituals by which individual Romulans live.



The *pontix* is the Romulan priest, who serves multiple purposes in Romulan religion. He conducts all public rituals, and thus inaugurates citizens to deeper levels of service and obedience. Likewise, he counsels the Romulan citizens in ways better to serve their families or their Empire. Romulan religion demands only obedience, not faith—but Romulan priests know a believer will naturally be more obedient than a citizen who acts merely out of social compliance. Romulan priests are thus often privy to personal secrets, and though there is no formal relationship with the *Tal Shiar*, more than once a Romulan priest has reported a citizen’s questionable activities and beliefs. *Pontices* are paid by the state—there is no division in Romulan society between church and state; there is only service to *D'era*.

Conquered peoples are at first denied access to these rites; they continue to practice their own native religions. Acculturation is the first step in dealing with a conquered nation, and after years of acculturation, the Romulan rituals are enacted. Only those subjects who receive Romulan citizenship may participate in these rituals—including receiving a Romulan name and receiving a Romulan burial. Through this process, a “convert” to Romulan ways accepts *D'era* and embraces the superiority of the Romulan way.

NIMAZ, OR NAMING

Within a week after a Romulan child’s birth, the family names him after a Romulan hero, a revered ancestor, or another prominent Romulan. This small, private ceremony affirms the newborn’s purpose in the Romulan Empire, and the child is raised aware of his future obligations. Parents choose a child’s name very carefully, and a Romulan child learns early in life whose great footsteps he follows.

TIMELINE

| Romulan | Terran | Event |
|---------|--------|--|
| 0 | 369 | Romulan Diaspora — proto-Romulans leave Vulcan under Tellus |
| 105 | 474 | Admiral Debrune leads dissident elements to Yadalla Prime and other worlds |
| 188 | 557 | Romulus founded |
| 213 | 582 | Tellus dies; Romulan Clan Wars begin |
| 295 | 664 | Romulus unified under Jo'rek; Kimara codifies <i>D'era</i> |
| 304 | 673 | Romulan conquest of Romii |
| 305 | 674 | Romulan Age of Expansion begins |
| 566 | 935 | Romulan Civil War begins |
| 569 | 938 | Romulan Star Empire organized; Senate founded |
| 901 | 1270 | Romulan-Vulcan wars begin |
| 1001 | 1370 | Romulan-Vulcan wars end |
| 1042 | 1411 | Romulans invent the magnetic bottle drive |
| 1327 | 1696 | Valkis XIV overthrown; rule of the Praetor established |
| 1672 | 2041 | First Romulan-Klingon War begins |
| 1700 | 2069 | First Romulan-Klingon War ends |
| 1787 | 2156 | Romulan-Earth war |
| 1791 | 2160 | Battle of Cheron: Romulan Neutral Zone established |
| 1897 | 2266 | RNZ violated: <i>Enterprise</i> encounters Romulans |
| 1898 | 2267 | Klingon Alliance established; Romulans gain warp drives |
| 1899 | 2268 | The " <i>Enterprise</i> Incident"; Romulan first encounter with the Breen |
| 1902 | 2271 | Battle of <i>Dumok'azen</i> (<i>Klach D'Kel Brakt</i>) |
| 1923 | 2292 | Klingon Alliance collapses |
| 1924 | 2293 | Khitomer Conference |
| 1942 | 2311 | Tomed Incident; Treaty of Algeron |
| 1964 | 2313 | The Taurhai attack |
| 1994 | 2343 | Battle of <i>Chi'tan</i> |
| 1975 | 2344 | Romulans attack Narendra III |
| 1977 | 2346 | Romulans attack Khitomer outpost |
| 1995 | 2364 | Romulan isolation ends |
| 1997 | 2366 | Admiral Alidar Jarok defects |
| 1998 | 2367 | Borg incursion into Diodor sector on Romulan frontier |
| 1999 | 2368 | Attempted invasion of Vulcan |
| 2000 | 2369 | Vice-Proconsul M'ret defects |
| 2002 | 2371 | Treaty allows for Romulan cloaking device on Defiant; Klingons attack Romulan outposts |

PYLANAZI, OR CITIZENSHIP

At age 20, the Romulan youth—on the verge of adulthood—affirms his allegiance to the Romulan Star Empire. This is a grand affair, as entire communities gather together each year to induct a new generation of Romulan men and women as new citizens of the Empire. Family gatherings and celebrations follow the ritual, and the recipient often receives gifts from older family members. These gifts are more than simply tokens of affection; they are often symbolic representations of the ideals of Romulan citizenship to which the new citizen has sworn allegiance.

SERONA, OR WARRIORSHIP

By age 30, the Romulan adult must pledge service to the Romulan military. This rite is formally required of all Romulan citizens; to ignore it is dissident treason. The rite itself, however, is as elaborate or simple as the citizen desires: It can be administered privately or publicly, in the presence of a Romulan military recruiter or in front of an entire community. The more proud, traditionalist Romulans prefer the public traditional *Serona*, in which feats of strength and endurance are emphasized to demonstrate that the Romulan citizen is not simply fulfilling a requirement, but is a worthy descendant of Romulan heroes.

Service in the Romulan military is a five-year requirement, after which most Romulans retire, having successfully completed their obligation. Other Romulans, however, remain in the Romulan military—either out of a greater sense of duty, in quest of adventure, or merely for career advancement.

Although it is not required of them, *Serona* service is the most common way for a conquered species to earn citizenship. These conscripts receive postings to nonessential services, typically undesirable duties far from home. Upon completion of the *Serona*, the client is granted citizenship, and may undergo the *Pylanazi* ritual.

SO'RDZ, OR UNION

The Romulan family is a revered institution, for the good family teaches its children the virtues of obedience and loyalty, and the productive family creates more good citizens to further *D'era*. *So'rdaz* is Romulan marriage, and it is a joyous celebration. The parents of both families cooperate in the planning of this event, for it represents the merger of two units to become one greater unit. Infidelity is highly frowned upon in Romulan society—infidelity to one's spouse indicates a predisposition to disloyalty, and no doubt the unfaithful husband or wife is equally capable of treason.

CHAROZZAH, OR PASSING

A Romulan's death is a somber occasion. When the Romulan dies, his spirit has entered the cosmos and become one with those who have passed before, and this is certainly a cause for celebration; yet sadness at the passing of a loved one is expected, as well. Romulan funerals are broken into two components: the burial, in which the dead person is physically reunited with Romulan soil, and the *Charozzah*, a commemoration of the spirit.

The *Charozzah* is a ten-day ritual observed by all members of the immediate family. Each Romulan household has a small altar venerating the spirits of those who have passed before, and this altar is adorned with a trinket belonging to the deceased, to represent the deceased's union with the great beyond. For ten evenings, the family gathers to recount events of import in the deceased's life, so that those events become part of the family memory. At the end of the tenth day, the majority of the deceased's belongings are either apportioned out to Romulans in need or simply destroyed. (Usually a few personal items are kept, for sentimental value, of course.)

A Romulan traitor or any other criminal against the state is denied the *Charozzah*. His body is cremated, and the deceased's belongings are destroyed as well. There is no retelling of events, nor are there any



formal remembrances of the deceased, who is considered—according to Romulan custom, if not to loved ones—never to have existed.

The dissident movement promoting reunification with Vulcan has begun slowly to undermine Romulan civil religion. Vulcan philosophy teaches one to turn inward, and those Romulans who secretly espouse Vulcan ideals have deconstructed their Romulan traditions, seeing them as merely ideological tools for social unity. These Romulan dissidents still publicly perform a number of rituals, in order to maintain the social order (and keep the *Tal Shiar* at bay), but they have added a number of other, private rituals of meditation and philosophical arts performed in private, away from prying eyes. A growing number of Romulans have begun to seek out the dissidents solely because of the promise of solace which these Vulcan techniques are alleged to bring. Whether this ultimately will lead to simple adoption of Vulcan ways, or a Romulan-Vulcan syncretism, none can say as yet.

A COMMON ANCESTRY

A pivotal moment in Romulan-Federation relations came in 2369 when the Romulan commander Savul encountered the *Enterprise*, and witnessed an ancient hologram declaring that all humanoid life sprung from a common source. The *Tal Shiar* tried its utmost to keep such heresy from becoming public, imprisoning Savul for daring to poison Romulan minds with such a report. In spite of the *Tal Shiar's* efforts, however, news leaked out of the archeological find. Acting quickly, the *Tal Shiar* made a public face of discounting it as Federation propaganda. Many Romulans casually dismissed it, but it struck a chord in the hearts of many other Romulans. Were these ancient beings the Vhorani? Old memories of emissary Caitlin Dar's suppressed report on her alleged voyage to *Vorta Vor* in 2287 resurface and circulate in the same underground circles. Are Romulans and humans more than simply neighbors, but kin? Should humans and Romulans therefore be partners rather than enemies.

Warriors of the Endless Sky: Romulan History

The Romulans are well known across space as a warrior people, and this is evident in their history. Yet between the hundreds of battles and the voracious expansionism of the Romulan Star Empire is a proud people with an ancient heritage, a people who live for duty and for the betterment of their own kind, following a strict code of conduct which has given their people a sense of meaning for millennia.

VHORANI, THE ANCIENT ONES

For many, Romulan history begins on Vulcan, with the proto-Romulan exodus as the Vulcans embraced peace and logic. While Romulans acknowledge their beginnings on Vulcan, and see the ancient Vulcans as their own ancestors, Romulan history reaches further back, before the Time of Awakening, to the prehistory of the universe.

The Romulans trace their history back to the Vhorani, or Ancient Ones—the earliest peoples who created the Vulcanoid species at a place called simply *Vorta Vor*, the Wellspring of Creation. The Vhorani seeded their creation on the planet that would one day be called Vulcan. These earliest people, according to the legends, adapted to life on the harsh planet of Vulcan, and evolved into the Vulcans known today. This hypothesis, first proposed by Tellus, forms the foundation of Romulan civilization (though the most successful expression of this idea is the epic poem *Vhortai*, which draws parallels between the journey of the Vhorani to Vulcan and that of Tellus to Romulus).

Most outside scholars, archaeologists, and historians—notably the Vulcans—see these as little more than mystical musings, substantiated by a few unsupported whispers in Romulan, and Vulcan, mythology. Little evidence of the Vhorani, or their original homeworld, exists, these scholars contend. The histories of other ancient civilizations—the beings known only as Sargon's People, to name one example—coincide with Vulcan mythology, and suggest other likely progenitors of the Vulcanoid species. Although the work of Professor



Richard Galen, a Federation archaeologist, and Captain Jean-Luc Picard confirmed the existence of an ancient humanoid civilization who seeded the oceans of many worlds with genetic material, few scientists are willing to link these ancient humanoids with the Vhorani.

THE TIME OF AWAKENING

The earliest Vulcans were a savage, bloodthirsty people, possessed by the spirit of war and controlled by heated emotions. So powerful were emotions to these ancient peoples that for each emotion and experience there was a god—a god of anger, a god of grief, a god of joy, and so on. The Vulcans believed that their gods gave them power in the form of their strongest emotions. The strongest god was *Ket-cheleb*, the god of war; his wife was *D'era*, the Endless Sky, who took the form of a great bird. In their names and in the names of other gods did the ancient Vulcans fight one another.

For centuries the earliest Vulcans lived and died in such battle, each fighting the other over the slightest provocation. Tribe attacked tribe, brother slew brother. This was the way of life, though, and this tested the mettle of those who would survive on the harsh planet. Many tribes became fewer, and these fewer tribes became states, and in time two great states grew, and each fought the other for domination of Vulcan. Legends of wars in the sky may indicate that ancient Vulcans developed the capacity for space flight and began colonizing nearby worlds—and even there, the fighting was as savage and petty as on their homeworld. (Archaeologists usually classify most Debrune ruins as proto-Romulan in nature, but some scholars believe that proto-Vulcan settlement is a viable hypothesis.)

Into this time came Surak, a Vulcan who spoke of peace and of controlling the raging fires within: "The mind controls the body," he said. "Control the mind that the body may follow." He spoke against the gods, claiming them false idols created to enthrone the emotions. At first, Surak was mocked and ridiculed, his teachings ignored as foolishness. But there was strength in his voice and his words, and in time small handfuls of Vulcan warriors put aside their blades and energy weapons to live the life of peace which he preached.

It started with only a few converts here and there, but soon entire cities came under his sway. Some Vulcans still spoke against him, but instead of just mocking him they saw him as a threat to the Vulcan way. Among these critics was Tellus, a great leader and warrior who had dedicated himself to *Ket-cheleb* and *D'era*. He saw his Vulcan brothers and sisters casting off their traditional ways and embracing the coward's path. "Do not douse the fires within," he urged. "Let them rouse your souls and awaken us to life!" Some Vulcans rallied to his side, emboldened by his words. They took arms against their pacifist brethren and slew them. But the peace-makers eventually won out and many converted to Surak's ways, and in time Tellus and his followers accused Surak's followers of abandoning their heritage and true natures.

Seeing what had become of his own people, Tellus renounced Vulcan and took to the stars; with him went his followers. Where Vulcan had abandoned the gods and their own nature, the followers of Tellus, the Children of *Ket-cheleb*, would find a new homeland where they would boldly and proudly proclaim the ways of glory. As *Ket-cheleb* embraced *D'era*, so did Tellus and his followers, who saw their departure from Vulcan not as an exile, not as a flight, but as a step into the Endless Sky.

THE ROMULAN DIASPORA

Tellus and his people set forth on impulse-engine-driven ships, huge hulking monstrosities that churned and rattled. On these great ships they began their slow journey across space, seeking a new homeland, one which Tellus knew beckoned to him. For decades they journeyed, learning more about the universe which surrounded them. (So significant was their journey from Vulcan that the Romulans began a new calendrical system, dating it from the year of their exodus.)

They lost some people to conflict, to disease—but the followers of Tellus and the warriors of *Ket-cheleb* were a proud people who would not be conquered by hardship or adversity. Only Tellus' leadership kept the warrior people from succumbing to internal warfare. Tellus motivated and inspired his Vulcan émigrés with his charismatic discussions of *D'era*, the Endless Sky, and how they fulfilled their ancient destiny.

But it was a long journey, and over the decades some of Tellus' followers abandoned their quest, tired of seeking an elusive promised land. Rebels and

dissidents under Admiral Debrune sought their own worlds, such as Draken IV, Yadalla Prime, and Barraut II. Over the next decade, other followers of Debrune and different leaders colonized Barradas III, Calder II, Dessica II, Jollan IV, and a handful of other worlds. Each of these worlds was adequate in its own way, but Tellus was never satisfied, and he pressed on. These settlements rarely lasted more than a few generations, and many left their ruins abandoned, hiding the secrets of ancient proto-Romulans. To this day there are rumors of forgotten planets which contain the descendents of these proto-Romulans: peoples who did not develop into the Romulan culture as we now know it, and either developed their own cultures or retained the early Vulcan lifestyle.

Tellus never wavered in his conviction that somewhere ahead lay a world on which his people could prosper and build a new Vulcan. Suddenly, as though through divine provenance, nearly one hundred ninety years after their departure from Vulcan, a wormhole swallowed the impulse-engine ships, depositing them in a system with an uninhabited world of pristine beauty. Tellus—by now a very old man—accompanied the first landing party to the surface, and as he set foot on the world, he announced that the pilgrims had found their destination. He named the world Rom'laas ("Romulus" in Federation Standard), after the home of *Ket-cheleb* in Vulcan legend.

THE FOUNDING

Romulus was a splendid world, and its colonists were proud and excited to have finally arrived—many of them had been born during the Diaspora and had never seen Vulcan, while for others Vulcan was but a fading memory. Romulus was a large world, with room for all. Over the first few years, the settlers spread out across the planet, selecting parcels of land to their liking, and Tellus watched as the future unfolded.

He witnessed the earliest days of the "Romulan"—as they now called themselves—clans, and when they began to fight, he was unconcerned. He knew many of the earliest clan disputes were trivial: These were Romulan warriors, not Vulcan philosophers, and it was in their nature to fight. As had been demonstrated in the past, through conflict and struggle the Romulans grew stronger.

When these conflicts grew too strong, Tellus would step in and intervene. "Waste not your energies against your brothers: There is an entire universe waiting for our dominion. Let the Romulan clans grow and thrive, and, when ready, we shall once more return to the stars!" With these words, he kept the ideals of *D'era* alive for the fractious clans.

THE CLAN WARS

The greatest challenge to the early Romulan years was the death of Tellus. Although old and blind, it had been only his personality and force of will that had kept the Romulan clans working in relative harmony. When he finally died—215 years after the Romulan exodus, at age 300—strife erupted across Romulus. Clan leaders fought and argued over who should lead, and bloody battles the likes of which had not been seen since Vulcan tore at the heart of the Romulan unity. The Battle of Xolleni Pass, the Gilgamma Massacre, and the *Jorani-Zorek* Wars left their marks on Romulan history. For over a century war swept the face of Romulus, as the

Clan Wars reshaped the planet, forging tribes into strong nations.

From the maelstrom rose Romulus' next leader: Jo'rek, the grandson of Tellus. He spoke with his grandfather's voice and negotiated with the disparate leaders, reminding them of *D'era*, the Endless Sky. "That Romulan should slay Romulan is intolerable," he counseled; "better to seek the stars as is our destiny. Romulus was not the end of the quest, but the beginning!" Under his aegis, the fractured Romulan nations began to reunite: some willingly, some not. As Jo'rek's army grew, he moved from diplomacy and rhetoric to more blatant military maneuvers. Those who remained unpersuaded were removed. Within a decade of Jo'rek's rise to power, all of Romulus had been reunited under one man. Under Jo'rek's leadership the Romulans turned skyward once more, taking to space in newly built ships.

ROMII

There could only be one target for those first ships: the next planet inward from Romulus, called Romii by its inhabitants. (Some historians speculate that it was radio transmissions from Romii that drew Tellus to that system on his quest for his legendary "*Rom'laas*".) Driven by Jo'rek's need for a unifying crusade and the philosopher Kimara's systematized ideology of *D'era*, a vast armada under Admiral Valdran crossed interplanetary space and attacked Romii's natives—the Zelvorians. Two months after the Romulans' first encounter with them, the Zelvorians were a subjugated people, and the Romulan banner flew overhead. The name Romii was almost preserved as the Romulans renamed the planet after the mythological son of *Ket-cheleb* and *D'era*, a name Federation universal translators converted into Remus.

The Zelvorians were the first to fall to Romulan expansionism, but not the last.

THE AGE OF EXPANSION

These were the glory days of Romulan history. Over the centuries that followed Romii's conquest and re-colonization, Romulan admirals encountered and subdued countless other civilizations. Their next sentient target after the Zelvorians was the Buqret, a race much more technologically advanced and hardly as peaceful. The Buqret shot the first Romulan scout ship out of the sky, and gave quite a fight in defense of their homeworld. A fierce people whose warrior drive exceeded that of the Romulans, it was only the Romulans' greater resources and technology that won them the day.

While some might argue the ethics of Romulan expansionism, it nonetheless provided a relative peace behind Romulan borders. For example, when the Romulans first encountered the Xhuj and the Noulleroi, the two species were at each other's throats, engaging in all manners of warfare (from covert to overt, chemical to atomic). Their hatred for each other was so great they could not unify even in the face of interstellar opposition, and continued on their path toward wholesale destruction. The superior Romulan forces destroyed the military headquarters of both species and removed their threat to each other: Within three generations of Romulan oversight on the Xhuj-Noulleroi homeworld, their ancient hatreds existed only in legends and the two lived together in harmony (albeit as Romulan vassals).

The early Romulan political structure was feudal, as powerful families, descendants of the original coloniz-



ing clans, ruled. As more worlds became part of Romulan space, the feudal structure weakened. Increasingly, successive Romulan monarchs ordered their troops into conquest after conquest, and Romulan forces became thinly spread. Administering far-flung holdings became difficult. 350 years after Romii's conquest, a military coup wracked the Romulan homeworld. For three years, the traditional feudalists of Romulus and the "young militarists" of Remus fought a series of brilliant battles still taught to Romulan ship commanders. The ramifications were felt across space, as a few worlds took advantage of the chaos to seize their independence. Finally achieving the strategic edge, Admiral Valkis (a collateral descendant of Tellus) declared himself Emperor, appointing the other admirals to a new Imperial Senate alongside the heads of the ancient families. Although Valkis was part of the Remus coalition, his wise compromise ensured a quick recovery for both sides. The Emperor led the state, the Senate managed the vast empire, and the Romulan Star Empire was born.

Centuries more passed as the Romulan Star Empire grew in accordance with *D'era*. Expansion efforts lessened: Although the Romulans still looked at the Endless Sky with anticipation, they realized that they had grown too much, too quickly, and they first had to stabilize their fledgling Empire before adding to it. Worlds that had fallen away during the crisis were reconquered, and the new era of growth began—slower than before but far better organized and more implacable.

THE ROMULAN-VULCAN WAR

In their quest for interstellar domination, it was inevitable the Romulans would encounter their Vulcan kin in battle. Where the Romulans had anticipated a glo-

rious military return to the planet of their origins, instead they found themselves in a century-long debacle that cost many lives and gained the Romulans nothing.

It began with a chance encounter in the Earth year 1270, as a still-unexplained spatial anomaly opened a wormhole between Vulcan space and Romulan space. Neither Vulcan nor Romulus had developed warp drive, and the distance between the two homeworlds was too vast to be easily traversed by sublight engines. Only through this wormhole—which opened irregularly, at times weeks apart, at times years apart—could the Romulans travel to Vulcan space.

What could have led to a rapprochement between the kindred peoples instead led to all-out war, fought with atomic weaponry. The Romulans quickly perceived what had happened and saw their opportunity to seize the home of their origin, sending in an advance fleet to conquer the pacifist Vulcans.

The Vulcans had embraced peace, but were not to be sheep for the slaughter, and they provided sufficient resistance to dispel Romulan attackers—attackers who seemed no different from any other belligerent people. Romulan ships were heavily armed, and it was not the Romulan way to accept defeat—so any Vulcan victory over a Romulan ship inevitably resulted in the Romulans detonating their arsenal in an act of self-destruction. The Vulcans never learned of their attackers' true heritage; the Romulans never communicated with their foes, vowing to make the first contact the announcement of Romulan rule over Vulcan.

For a century this long-distance warfare persisted, with Romulans emerging through the occasional wormhole, and with the Vulcans invariably—through sheer tenacity and well planned strategies—defeating the aggressors. This left its mark on the Vulcan people, though, who learned first-hand of Romulan ferocity in battle, and of the Romulan willingness to destroy civilian targets as a means to an end.

When the wormhole closed for good—as unexpectedly as it had opened—contact between Romulus and Vulcan ceased, and was not to be renewed for centuries. Later Romulans, members of the Vulcan Reunification Movement, saw this early encounter as a wasted opportunity: Their Romulan ancestors had had in their grasp an opportunity for peace, but had understood the spatial anomaly only as a means of further aggression.

THE EMPIRE FADES

The Romulans were stung by their defeat. Their massive Star Empire began to collapse, as resources had been wasted on supporting the war. A sequence of weak, decadent emperors almost brought the Empire to ruin before a military coup corrected the situation: Emperor Valkis XIV was deposed and replaced with a figurehead, who took on the title of Praetor and promised a return to ancient traditions.

Slowly, the Romulans began rebuilding their Empire. New races stumbled across the Romulans and fell to their aggression. Only the slow pace of Romulan warp-drive design hampered the Empire's expansion. A sufficiently determined and deadly foe could hold off the Imperial forces, and the Senate would eventually end the war for pragmatic reasons. In the late 21st century, for example, the primitive but extremely warlike Klingons managed to bleed dry enough Romulan attack fleets to convince the Senate to forego the war in that sector, leaving their Nausicaan client states to watch for Klingon rebirth. Balked in its rimward expansion, the Star Empire pointed its fleets coreward, and encountered humans.





THE ROMULAN-EARTH WAR

A Romulan warship on the fringes of Romulan space surprised an intruder (the Earth ship *Endeavor*) near the planet Cheron IV, but it escaped before it could be destroyed. A vengeful human armada attacked the Romulan fleet base near Cheron, but Earth's inexperienced crews and ridiculously underpowered ships were no match for the sword arm of the Star Empire.

This was the humans' first large-scale contact with an aggressor species, and Earth began to prepare for the attempted invasion they knew was coming. Romulan and human forces met and wrought horrible devastation on each other, using the most powerful weapons at hand: atomic weapons that would irradiate and poison their victims if they did not obliterate them outright. Romulans had the edge in skill and tactics; Earth had warp-capable ships. For centuries, the Romulans had depended upon ion-powered generation ships to carry the battle for *D'era* to other nearby stars. (Relativistic time dilation helped keep the experiential time down for the crew and soldiers on board, at least.) This slow travel partially explains both the relatively slow speed of Romulan expansion and the instability of the Empire before 1370.

After the Vulcan War, Romulan scientists attempted to duplicate the wormhole that had allowed them to strike at their lost homeworld. Unable to build a wormhole, Romulan shipwrights settled for a system reminiscent of the old Earth multistage chemical rockets. A Romulan warship deployed behind itself a single-use magnetic bottle containing caged superdense plasma; detonating the plasma created a brief, but directed, black hole which would fling the Romulan ship to a predetermined location faster than light. Varying the bottle configuration, plasma combination, and detonation time allowed a Romulan ship to travel anywhere within several hundred light years of a Romulan supply base. Romulan battleships could thus "warp" only in one direction; only a fleet base could supply the superdense plasma and reinstall a bottle. This made Romulan ships significantly more powerful pound for pound than enemy craft, however; they could put weapons and armor into space that Earth ships, for example, used for warp engines. For major invasions, ships equipped with

construction gear followed the advance craft, and built magnetic bottles in orbit around the target planet. Thus, ships without warp drive could still cross the vast distances between Romulus and the borders. However, even these advanced craft were no match for the maneuvering capacity that warp drives gave the Earth forces.

Slowly, Earth began to recruit and train better crews and build improved ships, while learning to use their advantages better. Finally, four years after it had begun, the war ended at the Battle of Cheron. Human trickery lured the Romulan fleet into a trap and obliterated it with overwhelming force warped in at the last minute.

Defeated, the Romulans agreed to a treaty via subspace radio, and the Romulan Neutral Zone was established: a mutually agreed-upon vector of space into which any entry by human or Romulan forces would constitute an act of war. Humbled, the Romulans retreated for over a century. Never during this conflict did humanity encounter a Romulan face to face; their appearance would remain a mystery for a century.

HUMANS AND KLINGONS

The Romulans remained quiescent along the human border, slowly devising a plan of action. They had been defeated before—but never so soundly. It was during this period that Romulan scientists developed functional cloaking technology, while experimenting with new weapons technologies. When the fleet unveiled the *Nhorazz*, the Praetor's flagship outfitted with plasma weapons and a cloaking device, the Romulan military decided it was time to test the humans.

A magnetic bottle propelled the *Nhorazz* to the edge of the Romulan Neutral Zone, and the Romulans began a covert operation of destruction. Cloaked, the Romulan *Bird of Prey* destroyed multiple Federation outposts before a Starfleet ship managed to destroy the *Nhorazz* through sheer luck. The Federation's decision to fight—coupled with the clear tactical weakness of Romulan warships—caused the Senate not to press further. Starfleet, to avoid a wider war, did not retaliate against the Romulans.

In 2267, however, the Romulans encountered Klingons again: More precisely, Klingon invaders attacked a Romulan colony. It was clear that if open

MAN

THE ROMULANS



war began, neither side would easily win—a situation the Romulans desired to avoid after their recent encounters with the humans. Romulan leaders realized it was in their best interests to ally with the Klingons at the moment, to learn more about them while avoiding an outright war that the Romulans were unprepared for. Attempting to avoid a potential two-front war, the Romulans signed the Narendra Agreements, binding the Star Empire to the Klingons technologically and politically.

Both sides profited from the alliance. The Romulans finally obtained the matter/antimatter warp drive, while the Klingons gained cloaking technology. The two forces together developed hybrid Klingon battlecruisers, cloak- and warp-capable vessels with the now-infamous *D7* body.

It was during this period that Starfleet—feeling increasingly threatened by the combination of the cloaking device and the Romulan-Klingon alliance—sent the starship *Enterprise* to steal a Romulan cloaking device. The Romulans retaliated by conducting raids into Federation space at Tau Ceti, only to be beaten back by Starfleet's starships (including the *Enterprise*). The weakened Star Empire retired behind the Neutral Zone again to lick its wounds.

Meanwhile, Romulan-Klingon relations became strained; neither side fully wanted an alliance, and compromises became harder to reach. Although the Klingons shared the Romulan ferocity and eagerness for battle, the Klingons fought at the slightest provocation. More and more, the Klingon Empire made it plain whom it considered the dominant partner in the alliance, and embroiled Romulan forces in futile battles against numerous minor powers. The Romulan Empire at first argued for moderation.

Conflict flared in 2271, as the Klingons demanded ownership of Dumok'azen, a mineral-rich world on the border of both empires. The Klingons and Romulans faced each other in open combat at the Battle of Dumok'azen (or Klach D'Kel Brakt, after the Klingon name for the planet). The Klingons defeated the Romulans and claimed a great victory, despite the fact that the Romulans were outnumbered. The Romulans bided their time, building more warp-capable battleships and watching Klingon forces stretch ever thinner. In 2292, the Senate abrogated the alliance and expelled Klingon ships from Romulan territory, destroying all Klingon ships remaining behind after the deadline.

The Romulans so disdained the Klingons that they considered the Klingons their blood enemies: not simply a civilization to absorb under *D'era*, but a people to crush. Beginning with subtle means, such as when the Romulan ambassador Nanclus conspired in the assassination of Klingon Chancellor Gorkon in 2293, and escalating to outright border warfare, such as the attacks on Narendra III (2344) or Khitomer (2346), hostilities have persisted between the two empires.

THE TOMED INCIDENT

In 2311, Romulan intelligence suspected the Federation of developing cloaking technology. Although the Federation vehemently denied such a claim—calling Starfleet a space-exploration fleet, not a military branch—the Romulans staged a covert raid across the Neutral Zone to Starbase 247. Located in the Tomed System, Romulan reports indicated this starbase as the location of Starfleet's cloaking experiments.

Starfleet sensors detected the cloaked ships and declared the Romulan incursion an act of war. The battle between the Romulan and Starfleet squadrons cost both sides thousands of lives. Losses were concentrated on Starbase 247, as two of the crippled Romulan vessels staged a suicide raid on the base. What seemed to be a Romulan victory was undone by the unexpected appearance of a cloaked Federation warship, which tipped the battle in the Federation's favor. The remaining Romulan vessel fled to Romulus, and Starfleet ordered its ships not to pursue into the Neutral Zone. The Romulans triumphantly pointed to this battle as evidence of Federation cloaking technology; the Federation claimed that Starfleet Intelligence had acted of its own accord in developing cloaking technology. The Romulans were unpersuaded.

The incident nearly sparked war between the United Federation of Planets and the Romulan Star Empire. Ambassadors from both governments were recalled home. The UFP reminded the Romulans that entering the Neutral Zone would constitute an act of war; the Romulans retorted by asking how their activities were any different from Starfleet violating Romulan space to steal Romulan technology. Tensions mounted on both sides of the border.

The situation was defused by a meeting of UFP and Romulan diplomats, who saw the loss of life on both sides as regrettable and who agreed the entire situa-

tion should have been avoided. Meeting on Algeron, the diplomats drafted the Treaty of Algeron—a document reaffirming that entry into the Neutral Zone without acceptable advance notice would constitute an act of war. It also affirmed that the UFP would not pursue cloaking technologies, which were inconsistent with the mission of Starfleet. The peace was maintained, but the Romulans isolated themselves from the UFP for years thereafter.

THE TAURHAI

Part of the impetus for this isolation came from an unexpected direction. In 2313, a new threat emerged. Appearing from nowhere, utilizing artificially constructed subspace funnels, the species known as the Taurhai attacked a number of Romulan worlds on the leading edge of their space. With so much of their attention focused on the Romulan Neutral Zone and potential encounters with the Federation, the Romulans were unprepared for this attack.

For thirty years, battle raged between the Taurhai and the Romulan Star Empire. A handful of worlds fell—some minor colonies, and some major worlds with ancient standing in the Romulan Star Empire. The Taurhai crept ever closer to Romulus, placing the Romulans in a far more defensive position than they were used to. Thousands of Romulan soldiers died bravely to defend their homeland from the threat of the Taurhai, and the Romulan fleet faced destruction.

The threats to the Romulan Empire fueled angry debates within the Senate. Perhaps the Romulan peoples had become lazy and decadent, and this was their wake-up call. How could the Romulans pursue *D'era* when they could not even maintain their own borders? This argument roused pride within the nearly defeated Romulan peoples, who mustered one last defense: No longer waiting reactively for further Taurhai incursions, they mounted a suicide attack against the Taurhai homeworld. With the Battle of Chi'tai, the Romulans—in their battered remnant of a fleet—drove off their would-be conquerors.

Many Romulans secretly thanked the Taurhai for presenting the challenge that brought the warriors back to their feet and reminded them of what battle is truly like. A new Romulan Star Empire turned back to face the Federation, renewed and strengthened by their experiences with the Taurhai. Some client races were even granted Romulan citizenship for their support during the Taurhai war. The Klingons, who had begun raiding Romulan territory during the Taurhai emergency, suffered condign punishment at Narendra III, Khitomer, Beta Thoridar, and other outposts. The unexpected appearance of a Federation starship at Narendra, however, halted the Romulan drive to eradicate the Klingons forever; the defeat at Tomed was too fresh, and the Empire too weak from the Taurhai crisis, to risk renewed war with the Federation.

THE FEDERATION, ONCE MORE

In 2364, an unknown force destroyed a number of Romulan outposts near the Neutral Zone. Suspecting malfeasance on Starfleet's part, a Romulan warbird was sent to investigate. The warbird encountered a Starfleet vessel, the *U.S.S. Enterprise*, precipitating the first Federation-Romulan dialogue in fifty years. Learning of similar attacks perpetrated on Starfleet outposts, the Romulans stood down—but only after warning Starfleet

that the Romulans had only been detained by other business, but were now ready to deal with the Federation once more.

A number of other chance encounters occurred between the Romulans and the Federation—such as when Starfleet officers violated the Neutral Zone and experimented with ancient Iconian technology (nearly sabotaging the *Haakona*, a Romulan vessel sent to investigate), or when a Romulan scout ship crashed at Galorndon Core, in Federation space. Still, these events were enough to convince the Romulans to reassert its presence in the Alpha Quadrant, and the Star Navy dusted off its old war plans.

Once more Romulan dissidents spoke against war. The *Tal Shiar* used one such proponent for peace, Admiral Alidar Jarok—at one time a Romulan hero—to set a trap for Starfleet, as the *Enterprise* approached Nelvana III. The war which almost began just as quickly ended when Klingon vessels appeared in defense of the *Enterprise*.

Romulan leaders saw they were not yet ready for an open war with the Federation, particularly as it was now allied with the hated Klingon Empire. This alliance represented a major shift in the balance of power in the quadrant, and the Romulans faced what they'd always feared—a two-front war with the Federation and the Klingon Empire. The Romulans focused on what they considered to be the weak link in the alliance, beginning a scheme of covert involvement in Klingon politics, in the hopes of bringing that empire to collapse. Sela, a young human-Romulan half-breed *Tal Shiar* operative, proved to be a vital component of these missions, as she masterminded or spearheaded various ploys, such as her kidnapping and reprogramming of a Starfleet officer in an attempt to assassinate a Klingon governor. Romulans soon discovered that a number of Klingons could be persuaded to ally with the Romulans against Klingon honor. The House of Duras was easily tempted to side with the Romulans in support of their own, naked ambitions, eventually leading to the Klingon Civil War. Had not the Federation intervened in support of Gowron, a renowned Klingon warrior, the Duras family would have ascended to leadership of the Klingon council and abrogated the Khitomer Accords.

REUNIFICATION

One of Sela's most elaborate plots—and if it had proven successful, certainly the most dramatic—involved the Romulan-Vulcan reunification movement. This group of dissidents does not simply reject militant *D'era*: They argue for a peaceful reunification with the Vulcans, that ancient grudges be put aside and old wounds healed. Not content with simply abandoning their heritage, the dissidents pushed for their entire people to suborn their will to the pacifist philosophers on Vulcan.

Sela saw a way to use this movement, and working with Pardek, a Romulan Senator who had at one time actually entertained reunification ideas, she schemed to bring the Vulcan Ambassador Spock to Romulus. Sela saw that he would become a linchpin in her plan to reclaim Vulcan—reunification by military conquest was superior, and it would also strike at the heart of the Federation. Her plan would have succeeded had it not been for the covert intervention of Starfleet officers on Romulus. (Any other occasion, and the Romulans would have interpreted this as an act of war. On this occasion, considering the context, they were not concerned with such legal issues as violation of treaty.)



The Starfleet officers escaped Romulus after foiling Sela's plan, but Ambassador Spock remains on Romulus, hoping to teach more Romulans of their Vulcan heritage.

ANOTHER BROKEN TREATY

In 2370, the Romulans learned of a secret Federation program to develop cloaking technology, in violation of the Treaty of Algeron. Moreover, *Tal Shiar* agents uncovered hints of a new Federation advancement, the phasing cloak, which rendered a ship not only invisible but capable of passing through matter. The Romulans were eager to obtain this technology for their own uses, and searched for the *U.S.S. Pegasus*, the test starship for the new device.

Starfleet Intelligence learned of these Romulan efforts, prompting Admiral Erik Pressman to locate and salvage the phasing cloak. Years before, Pressman had been the captain of the *Pegasus*, and in charge of the covert testing of the phasing cloak. The official story, supported by Pressman's testimony, reported the *Pegasus* lost in a warp-core breach, but in truth the starship was actually embedded inside an asteroid in the Devolin system, the victim of its own phasing ability. With the Romulans close at hand, Pressman, on board the *Enterprise-D*, located the ill-fated ship. When the nature of the *Pegasus* and Pressman's interest in it became clear, the *Enterprise* captain placed him under arrest for violation of the Treaty of Algeron.

The Romulans were stunned to learn that a human officer would so willingly and publicly reveal misdoings at Starfleet. Some Romulans saw it as dishonorable, for no loyal Romulan would ever perform such a treasonous act against his own military. Others saw it as highly honorable, proof that Starfleet respected the Treaty of Algeron.

Romulans watched the proceedings with interest, as a Starfleet investigation uncovered—and publicly revealed—the wrongdoing of senior officers. In the end, Starfleet offered an apology to the Romulan Star Empire, and a later treaty in 2371 actually allowed for a Starfleet vessel to use Romulan cloaking technology in the UFP's war against the Borg. Later, this vessel, the *U.S.S. Defiant*, would play a critical role in the Federation's conflict against the Dominion.

A COLD WAR HEATS UP

The discovery of a stable wormhole in the Alpha Quadrant, near the relative backwater of the planet Bajor, at first did not concern the Romulan Empire. Although a stable passageway to the Gamma Quadrant provided the Federation, Klingons, and Cardassians with new territory to explore, Romulan military leaders assumed they would one day seize the wormhole for themselves; in the meantime, they allowed others to expend their resources on exploration. When the Gamma Quadrant empire known as the Dominion revealed itself, the Romulans became concerned.

The Dominion represented a potential threat to the balance of power in the Alpha Quadrant. The Dominion's Jem'Hadar ruthlessly attacked Alpha Quadrant ships traveling through Gamma Quadrant space. In an attempt to circumvent a Dominion invasion, the *Tal Shiar* allied itself with the Cardassian Obsidian Order, in a bold plan to attack the Dominion homeworld. A stunning Jem'Hadar ambush destroyed both fleets, and the Empire suffered a tremendous loss in manpower and material. Better, Romulan strategists

thought, to leave the Dominion to the other powers in the Alpha Quadrant, and build up forces for the Dominion attack to come.

Emboldened by their success, Dominion forces pressed their advantage and invaded the Alpha Quadrant. The Cardassians negotiated a surprise alliance with the Dominion, with the Dominion obtaining bases from which to strike and additional, Cardassian, manpower, while the Cardassians preserved their territory from Dominion attack. From Cardassian space, the Dominion seized key Federation planets, and pressed the Klingon Empire. Still the Romulans remained on the sidelines. When the Federation uncovered a plot by the Cardassian-Dominion military command to invade Romulan space, the Romulan Empire could no longer sit idly by. The Praetor, with the Senate's backing, declared war on the Dominion, and joined the war on the side of the Federation and Klingon Empire.

Despite this newfound cooperation, Romulan-Federation relations continue to be strained, but there is room for hope: Neither trusts the other, but it is more difficult to see the other truly as the enemy. A growing number of Romulan Senators, notably Senator Cretak, see the alliance with the Federation as an opportunity; although loyal to the Empire, and to the *Way of D'era*, these Romulans have developed a less militaristic interpretation of *D'era*. Some have even said in public, "Let our way be spread through peace and influence: Either way we still shall control the stars."

Hard-core Romulan loyalists seethe upon hearing this, and dread what they fear their Empire may become: peacemongers without glory, who would let the Romulan way—the *Way of D'era*—falter. Some Senators and admirals prepare for the period after the Dominion war, and for a new battle for control of the Alpha Quadrant, while others see the alliance for what it is—expedient. Other Romulans see new areas for growth and exploration: Certainly with strong neighbors at the Romulans' side they can explore further into space, into areas previously uncharted. Will the Federation-Romulan alliance end with the Dominion War, or is this a historic opportunity for peace and reconciliation? Only time and fate can tell.

THE CONSCIENCE OF THE EMPIRE



The Romulan government, particularly the Senate, decides policy and charts the future of the Empire. The Romulan Star Empire is a republic, if an oligarchic one; it has elected officials who represent the interests of the people and the Empire as a whole, as well as an elected head of state (the Praetor). Senators are among the most powerful and influential people in the Romulan Empire, deciding the fate of entire star systems and furthering their personal agendas while seeking greater glory for themselves and the Empire.

The Romulan government is in many ways a microcosm of the Romulan character. It is filled with labyrinthine plots, closed-door dealings, and individuals maneuvering for political advantage. More than any other aspect of Romulan culture, politics is a complex game of chess, of move and counter-move, risky gambits, strategy, and cunning. A career in Romulan politics has the potential for great rewards, but also carries considerable risk for the overly ambitious.

The Praetor

"The honor of the Praetor is the honor of the Empire." So goes the Romulan saying, and it remains true to the present day. The Praetor is the leader of the Empire and of the Romulan people. He (or she; Romulan women can become praetor) is the very embodiment of the Romulan ideals of honor, accomplishment, discipline, and, most importantly, *D'era*, the destiny of the Romulan people to spread out and conquer the stars.

Originally, one person, who held supreme power, led the Romulan feudal system. Often, this figure came from a prominent Romulan family, and rose to power by outwitting or overpowering all opposition standing between him and the throne. Thus, a Romulan monarch ruled by virtue of being the strongest, most cunning, and most capable candidate. This arrangement originally suited the warlike nature of the Romulans, but under successive rulers Romulan territory expanded haphazardly. The Romulans found themselves spread thinly, and it increasingly became difficult to hold on to territory seized. Meanwhile, the Romulan people lacked a voice in their government, leading to popular uprisings against unpopular leaders and further destabilizing Romulan society. The Civil War begun in 935 replaced this system with a formal Empire, and Admiral Valkis proclaimed himself the Emperor Valkis I in 938.

Valkis I originally established the Romulan Senate to advise him. The position of senator initially went to the admirals who had supported Valkis and to the leaders of prominent Romulan families, particularly landowners, since the Emperor needed their support and the support of the people they represented. At first the Senate held no political power of its own: It could advise the Emperor, but did not make decisions. As the Empire grew in size and complexity, and Romulan civilization coalesced into something beginning to resemble the modern Empire, the Emperor invested the Senate with more authority to handle many day-to-day affairs.

Over time, the power of the Senate waxed and the power of the Emperor waned. To the Romulan way of thinking, the Senate provided a more stable and reliable means of governing the expanding Empire. No matter how capable, no one person could administer an Empire the size the Romulan one was becoming. The Senate provided a forum for debate, discussion, and innovation sometimes lacking under individual emperors. More and more, the Senate's responsibilities increased. The Emperor was a popular figurehead, but the senators controlled their own provinces, their own houses, and, eventually, their own private armies.



After the failure of the Vulcan War and the desuetude of the rebuilding period, the Senate replaced the Emperor. Using their political influence at home, and marshaling their private armies, the senators convinced the Emperor to accept a lesser role, in much the same way Earth's ancient English Parliament forced the English king to accept a constitutional monarchy. The senators did not wish to dispense with a central executive. They realized that, although they governed the Empire more effectively, the Romulan people still needed a single figure they could look to for leadership and guidance: someone who embodied the Romulan ideal and inspired the loyalty of the populace while the Senate quietly ran the government and acted as the power behind the throne, humble servants of the Empire. That person was the Praetor.

BECOMING PRAETOR

The Praetor of the Romulan Empire is an elected position, chosen by the members of the Romulan Senate. In order to become Praetor, a candidate must be able to win the support of enough senators to ensure his election. First, the candidate must be a full-blooded Romulan. The Praetor represents the Empire and the Romulan people, and no alien can possibly do so.

More importantly, a potential candidate must capture the hearts of the Romulan people and the Public Assembly. Although the Senate may appoint an unpopular Praetor for reasons of practicality or political gain, they are far more likely to choose someone who can easily fulfill one of the position's primary duties: acting as a spokesman and popular leader for the whole of the Romulan people. On the other hand, the opinion of non-Romulans matters very little in the selection of a praetor. In fact, the Senate tends to prefer candidates feared rather than liked by potentially troublesome client states.

For this reason, Praetors are often military heroes with long and glorious careers, popular with rank-and-file Romulans. Less often, senators propel themselves into the Praetorship using their office as a platform to rally popular opinion, and advancing a public agenda that coincides with their ambitions. Not all Praetors come from one of the influential Romulan families. Some Praetors have had humble beginnings, although all have had at

least the support of the major families and factions to achieve their position. The Praetorship is sometimes passed down within the same family, but this is by no means the rule.

The position of Praetor is for life, until the Praetor willingly retires or is replaced by a vote of the Senate. It requires at least a three-quarters vote for the Senate to remove a praetor from office, so most of the major factions must be in agreement for it to happen. The Senate is also wary of replacing a popular Praetor, for fear of public outcry. Of course, factions opposed to the current Praetor may try to engineer scandals to eliminate the Praetor's public support and make it easier to have him removed. The *Tal Shiar* have been known to topple Praetors who oppose them too openly or too often.

Generally, most Praetors gracefully retire after years or even decades of service to the Romulan people. Some even return to the political life of a senator or consul, giving them considerable influence in the Senate (along with no small number of political enemies). Some Praetors have died in office, occasionally under mysterious circumstances. Rumors abound, hinting that the Senate and the *Tal Shiar* are not above arranging for the elimination of a troublesome Praetor who cannot be removed from office through any other means.

The current Praetor is Neral, former Proconsul of the Romulan Senate, with an illustrious past history of serving the Romulan Empire and its people. (For more information, see page 39 of *Romulan Characters*.)

THE ROLE OF THE PRAETOR

Although the Praetor has broad powers, including supreme command over the Romulan military, the authority to interpret laws and enforce them, and the authority to inflict the death penalty, the Senate retains the power to enact laws. The only check on the Praetor's power is the Senate's ability to remove the Praetor's authority by removing him from office.

The most important role of the Praetor—at least in the eyes of the Senate—is acting as an inspirational role model for all Romulans. The Praetor is the living embodiment of the Empire and *D'era*, a living, breathing person to whom Romulan soldiers and citizens can swear their



unding loyalty and allegiance. Although respect for Romulan virtues and loyalty to the Empire are taught to all citizens from childhood onward, the Praetor provides a popular symbol of those otherwise abstract intellectual concepts.

In essence, the office of Praetor is far more important than any one individual. Praetors largely give up use of their individual names upon their election. The Praetor is simply referred to as "the Praetor," as though the position has a life of its own, which, in many ways, it does. Only rarely (and then only in official histories) is a Praetor referred to by name, such as "Praetor Neral," usually to distinguish him from other Praetors.

The Praetor has great influence over popular Romulan culture. Fashions and activities at the palace become trends throughout the Empire. The Praetor's speeches fire the spirits of the people and provide support for particular legislation or initiatives on the part of the Senate. The Praetor's image gives the people hope in times of trouble and helps inspire loyalty at all times.

While the Praetor is the supreme commander of the Romulan military, the Senate wields considerable influence. (Many senators control their own personal fleets, especially senators who also serve as planetary or sector governors.) The Praetor orders the deployment of troops and starships, but the Senate controls the appropriation of resources needed to build new ships and recruit new soldiers. Similarly, the Senate enacts legislation and supervises the government's daily operations, but the Praetor enforces Romulan law.

THE PRAETORIAN GUARD

As supreme military commander, the Praetor controls a special cadre of troops known as the Praetorian Guard. The Praetorian Guard answers only to the Praetor and is unswervingly loyal. Praetors with military experience often appoint former military colleagues and subordinates to the Praetorian Guard upon their installation, and garner many military supporters through the promise (or even the hope) of a position in the Praetorian Guard as a reward for loyalty and service.

By tradition, the Praetorian Guard is made up of a full legion of Romulan troops, along with the various support personnel and resources necessary to maintain them. The Guard has its own ships as well, usually a fleet of *D'deridex*-class warbirds plus supporting vessels. Traditionally, only the Praetorian Guard may keep armed vessels in orbit around Romulus.

The primary duties of the Guard include attending the Praetor during all public and ceremonial functions and escorting the Praetor wherever he might travel. On occasions when the Praetor must leave Romulus, he always travels on board the flagship of the Praetorian Guard, escorted by other Romulan ships.

In addition to their ceremonial duties, the Praetorian Guard make a useful resource for the Praetor. Praetors have used members of the Guard as their personal agents, spies, and assassins to carry out missions too sensitive to entrust to anyone else (especially if the Praetor happens to be out of favor with the *Tal Shiar* or the Senate). Members of the Praetorian Guard are sometimes appointed to positions on ships or outposts in the camp of particular senators, either to support the Praetor's allies or to spy on his political enemies. It is even rumored the Praetor has Guard members within the *Tal Shiar* itself, to keep watch over the intelligence organization and report any indications of disloyalty or deception directly to the Praetor himself. Thus, the Praetorian



Guard and *Tal Shiar* act as checks on each other's potentially dictatorial powers.

The Continuing Committee

The relationship between the Praetor and Senate can be a confusing one. The Senate installs the Praetor, but the Praetor wields broad discretionary powers. The Senate passes laws and resolutions, but the Praetor is responsible for enacting those laws (and sometimes chooses not to). Often, the Praetor determines the Empire's direction, and the Senate serves as a "rubber stamp." Yet the Senate has the power to remove a Praetor from office. Despite these contradictions, the Romulans make this system work, through an organization known as the Continuing Committee.

Composed of the Praetor, the chairman of the *Tal Shiar*, three military officers, the proconsul, the vice-proconsul, and the leaders of the political parties, the Continuing Committee serves as an executive board to determine policy. Should the Senate disapprove of the Praetor's actions, Senate leaders can bring up their concerns here. Should the Praetor object to legislation making its way through the Senate, he can state his case. Military leaders and the *Tal Shiar* can weigh in with their opinions as well. Informally, here the major estates of Romulan society can "take each other's temperatures."

The Continuing Committee is designed to foster compromise and agreement. Each branch reports on any matters of import, from the Praetor conferring with Senate leaders on flooding in the Krocton Segment to military leaders reporting on a glorious conquest. Any disagreements or decisions are put to a vote, after each side weighs in with their opinion. A simple majority vote settles the issue.

As with anything in Romulan politics, things are not as simple as they appear. The military often sides with the Praetor, giving him a bloc of votes on which he can count (that he normally appoints the admirals to the Committee only helps). Though the Praetor is technically first among



equals on the Committee, with a greater say than others, wise Praetors do not act should the mood in the Senate run against him. Meanwhile, the Praetor can make life difficult for those senators on the Committee who oppose his policies, by dragging his feet on a senator's pet project. Although senators outnumber the Praetor on the Committee, they are characteristically loath to vote against him, and be seen to obstruct a popular ruler. Senators typically refrain from publicly questioning the Praetor's actions, instead allowing the leadership to do so behind the Committee's closed doors; there, they have been known to issue ultimata to the Praetor, including the ultimate threat—removal from office.

The Romulan Senate

The Romulan Senate is the supreme governmental body of the Star Empire. It maintains complete control over the appropriation of the Empire's resources, determines and executes foreign policy, and makes and ratifies treaties. It approves or disapproves legislation, as well as the elections of tribunes and government officials, and it determines who will be entrusted with the powers of the Praetorship. The Senate is the guardian of the Empire and the conscience of the republic, humble servants of the people and protectors of *D'era*.

The Romulan Senate is also a center of political intrigue and infighting. The most ancient and noble families of the Empire struggle daily to further their own causes, for the glory of the Romulan Empire and often for their own personal advancement. The Senate is divided into many different factions, intended to bring many voices into Romulan politics, but also providing checks and balances that play each faction off the others.

THE ROLE OF THE SENATE

The Romulan Senate is the supreme governing body of the Empire. Although the Praetor is considered the leader

of the Empire, the Senate makes laws, appropriates and controls resources, handles diplomatic contact, and makes or breaks treaties. The Senate appoints the Praetor and has the power to remove him from office. The Senate has very little leverage to use against the Praetor, beyond the threat of removal from office. It cannot veto the Praetor's decisions, though it can pass (nonbinding) resolutions calling upon him to act in accordance with its wishes. Because of the number of votes required and the instability it creates, removing a Praetor from office can be difficult, and happens infrequently. Given the consensus-building nature of the Continuing Committee, the Praetor and Senate infrequently disagree on matters of policy.

The Senate gives each province a voice in the governing of the Empire, although the political influence of Romulans is far greater than that of any of the Empire's client races, and the voice of older provinces is stronger than that of newer ones. To the Romulan mind this is as it should be. Ancestry and experience are important, so older provinces should have more say in how things are done. Some dissenters believe the Romulan system should be more equitable toward other species and new provinces, but their voices are weak and understandably lack political support.

Most importantly, the Romulan Senate is entrusted with guiding and nurturing the destiny of the Romulan people. The Senate ensures that the Empire remains prosperous, strong, and continuously expanding outward into new territory. Although how quickly the Empire should expand is often debated among senators and their coalitions, no one questions the fact that it is destined for the Romulan Star Empire one day to span the galaxy.

SENATORS

The Romulan Senate is made up of hundreds of senators representing the various provinces of the Romulan Star Empire. A senator is appointed for life, until he chooses to retire or is removed from office by the Senate. Many senior senators have held office for as long as a century, and such long careers are not unusual, given the average Romulan lifespan.

Each senator represents a province of the Empire in the Senate. Since not all provinces are divided equally, senators vary in terms of power or prestige based on the provinces they represent. For example, Romulus and Remus are divided into individual provinces, each with its own senators. On the other hand, a province in a newly settled area of Romulan space may contain more than a dozen star systems and several colonies, but have only one representative in the Senate.

This tends to weigh the Senate heavily toward senators who represent the interests of the Romulan core worlds and provinces, while still giving some voice to every province. Newer provinces constantly lobby for additional senators, although this always entails subdividing the province into smaller regions, which is not always desirable. Senators regularly debate this issue. Usually the smaller coalitions of the Senate favor the establishment of new provinces, since it gives them an opportunity to offer new senatorial candidates and gain members.

Senators traditionally live in the provinces they represent, maintaining homes there, but they spend most of their time on Romulus, where the Senate meets. Senators of the provinces on Romulus, like Senator Pardek, are known for walking through the streets of their provinces, meeting with the common people and hearing their concerns.



BECOMING A SENATOR

Like all other major governmental positions in the Empire, the majority of senators are Romulan, although aliens who attain full citizenship can become senators as well. Senators were originally representatives of the wealthiest land-owning families on Romulus, and those families still hold their Senate seats centuries later. An individual from more humble beginnings must have some considerable accomplishment as a politician or military officer in order to gain the favor of the Senate.

The Senate itself appoints new senators. Whenever a vacancy opens in the Senate—due to the creation of a new province, or the death or retirement of an existing senator—the Senate receives nominations for the position from the major coalitions of the Senate, as represented by their consuls. Technically, any current senator may nominate a candidate for consideration, but traditionally the coalitions each choose a candidate. The candidate must be either a Romulan or naturalized citizen, and have a distinguished career of service to the Empire or a noble and honorable lineage, preferably both.

The candidates have several months to campaign for the position. They spend this time in public debates, gaining popular support among the Romulan people and making alliances with key senators and coalition members to secure their votes. The process concludes with each candidate delivering a speech to the entire Senate from the Senate Forum. These speeches are recorded and broadcast throughout the Empire. Then the Senate votes, and the candidate with the most votes is installed as a new senator.

Senatorial positions are often inherited, and the Senate tends to favor strongly the chosen successor of a retiring senator unless there is some reason why he is clearly unfit. The competition for new Senate seats is fierce, as each coalition desires to increase its influence, and the powerful Romulan families try to add another Senate position to their holdings. Such campaigns tend to be riddled with infighting and political maneuvering as deals are made and broken behind the scenes to secure every possible advantage.

COALITIONS

The Senate is divided into different political coalitions, groups of senators with similar political goals and ideologies who band together out of mutual interest. These coalitions exercise considerable influence over the decisions and policies of the Senate, depending on which coalitions are currently in power and which are out of favor. No senator can survive for long without the protection and assistance of a coalition, and few senators are elected without the backing of at least one.

Coalitions within the Senate are fluid, shifting rapidly with each change of the political climate. Coalitions ally with others on an issue, then turn on their former allies over a new issue. Old coalitions break up and new ones form on a regular basis. A senator might change coalition affiliation many times over the course of his career, and coalition membership often determines a senator's friends (or at least allies) and enemies. These alliances and rivalries can shift with startling rapidity; entire coalitions can reverse themselves from week to week.

Despite this, several fairly stable coalitions have arisen in the Senate, based on age-old issues of Romulan politics that surface again and again. These coalitions are the largest and most influential, often containing various smaller coalitions that share similar goals but differ on the

finer points of ideology and implementation. The major current coalitions are described below. Many others exist within the Senate, but most are of a more transient nature.

JARIDAN

The Jaridan Coalition is the current ruling coalition, having the largest number of members and the greatest influence in the Senate. It is based on strong support for the Romulan military, providing a constant influx of resources for the construction of new ships and the recruitment and training of new military personnel. The Jaridans support a policy of continual outward expansion for the Empire in keeping with the ideals of *D'era*. They support new campaigns to explore and conquer newly discovered worlds and an ongoing policy of confrontation with the Empire's enemies, like the Federation and the Klingon Empire. They believe that military support and continued expansion help ensure economic prosperity and stability for the Empire.

Not surprisingly, the Jaridan Coalition receives support from the majority within the Romulan military. Many of its members are former military officers themselves, who retain ties to their former commands and have considerable military resources to draw upon. The current Praetor favors the Jaridan Coalition and is supported by them.

NEJ'AHAR

The Nej'ahar Coalition is the Jaridans' closest rival and the second largest coalition. They focus strongly on domestic issues, such as economic growth and education, while maintaining order and stability within the Empire. Nej'ahar members fear potential instability within the bounds of Romulan space, and argue that constant outward expansion stretches military forces too thin. They prefer to see more military resources devoted to garrisons on conquered systems, and additional security provided for key worlds. To placate the average citizen, they support programs of economic growth for Romulan worlds and the improvement of living conditions and quality of life for citizens of the Empire. In particular they support better education and medical care for all citizens. Some consider the Nej'ahar Coalition a bit soft because of their focus on internal matters, but their firm "law and order" stance helped to dispel such ideas until the defection of Vice-Proconsul M'ret (see p. 29) brought them back in force.

Many powerful and wealthy families support the Nej'ahar. They seek to maintain traditional Romulan values and to protect everything the Empire has achieved. For many members of the coalition, their duty is to their ancestors to guard the glory of the Empire from all threats, both foreign and domestic, and to ensure a better life for all Romulans. Developments like the Reunification Movement greatly concern the Nej'ahar.

JOL TAN

The Jol Tan Coalition stresses the loyalty of all citizens of the Empire as the utmost priority. This focus is likely why the Jol Tan strongly supports the *Tal Shiar* as maintainers of loyalty and order. Many privately say the coalition has grown politically because of the efforts of the *Tal Shiar*, winning some senators over through their unending work to protect the Romulan people and others through blackmail and similar means of persuasion. In fact, it is widely believed that the Jol Tan Coalition does the bidding of the *Tal Shiar* rather than the other way around,



although anyone who wishes to avoid a visit from the *Tal Shiar* never says so in public.

In the Senate Jol Tan members support the policies and goals of the *Tal Shiar*, both public and secret, ensuring the *Tal Shiar* is well funded and supplied and that their operations receive little interference, giving them sweeping authority to handle matters as they see fit. Some members of the Senate grow concerned about the influence of the *Tal Shiar* and the increasing power of the Jol Tan Coalition. Members of the Jaridan Coalition in particular distrust the Jol Tan, due to the traditional friction between the *Tal Shiar* and the military. Some outside the Jol Tan have become concerned that the *Tal Shiar* may grow too powerful, but no one has yet been willing to speak of the matter publicly, and many who do so privately end up under the *Tal Shiar's* watchful eye.

SUKETH

The Suketh Coalition is considered an aberration by many in the more traditional coalitions, but it still has support from many in the Senate. The coalition promotes the ideal of *D'era*, but believes the Romulan Empire may be expanding too quickly, that the Empire has fought too many wars and needs to take time to absorb and integrate worlds already taken. Time also is needed to recover from losses to enemies like the Taurhai before continuing to expand and engaging old enemies like the Federation or the Klingons. The Suketh say that the Empire may stretch itself too thin by fighting and expanding on too many fronts, until the strain becomes too great and tears the Empire apart.

The other coalitions consider the Suketh alarmists at best, potentially disloyal or traitors at the worst. Still, there is a growing movement within the Senate that says Romulus has had enough war for a time and calls for a focus on peace and the building of alliances. This movement gives the Romulan political underground hope, but it is still far from the radical politics espoused by members of the rebellion. In fact, some of the oldest and most conservative families on Remus support the Suketh positions out of deep concern for the rapid changes Romulan expansion has created. The Suketh Coalition held a great deal of power in the Senate between 2311 and 2364, while the Empire withdrew from testing the Federation. The *Tal Shiar* watches members of the Suketh Coalition closely for any signs of disloyalty. Thus far, they have evaded any hint of scandal, but it remains to be seen for how long they can keep their reputations spotless.

CONSULS

The head of each major coalition within the Senate holds the office of Consul. A consul speaks for his coalition, serves as the public leader of the coalition, and represents the coalition on the Continuing Committee. Being a consul is a position of considerable public exposure, and consuls are often targets for political schemes aimed at their coalitions, since weakening the consul tends to weaken the position of the coalition as well.

A consul who suffers such a loss of influence is expected to resign for the good of the coalition, and coalitions can vote to elect a new consul at any time. Consuls may also exercise other powers, but key governorships and ministries remain in the hands of the consuls of the major coalitions.

THE PROCONSUL



The Senate chooses a proconsul and a vice-proconsul to lead it. Generally, both are from the ruling coalition of the Senate, but occasionally a vice-proconsul is chosen from a different coalition as part of an alliance or agreement between two coalitions.

That is currently the case, with the proconsul belonging to the ruling Jaridan Coalition and the vice-proconsul belonging to the Jol Tan.

Proconsular appointments last for ten years and may be renewed by the will of the Senate. Many proconsuls serve for decades, and there is no limit to the number of terms a proconsul may serve. Proconsuls tend to rise and fall with their coalitions, although a proconsul can also be removed from office by a vote of the Senate because of illegal activity or political scandal.

The proconsul controls the lion's share of the political power within the Senate. Since the proconsul represents the ruling coalition in the Senate, he she has vast influence. He sets the Senate's agenda, determining what issues will be debated before this august assemblage, and deciding what matters will be brought to a vote. The proconsul can tie up legislation indefinitely, effectively killing it, or bring the matter to a quick resolution. The proconsul can be a Praetor's most effective ally in the Senate, or a formidable foe. When the two agree on policy, the proconsul endorses the Praetor's programs in the Senate, while the Praetor enacts legislation supported by the proconsul (and his coalition). Should the two leaders disagree, the proconsul can bring considerable pressure to bear. One of the primary roles of the proconsul is in the area of diplomacy. The Senate handles diplomatic relations between the Empire and other nations, and the proconsul has considerable voice in dictating how the Empire deals with its neighbors. While many Romulans want to become Praetor, the truly ambitious aspire to the office of proconsul.

The current proconsul, Kota, only recently assumed office. He is a fairly young, ambitious proconsul, with grand ideas and goals for the Romulan Empire. Although Kota was able to rally the support needed to put himself in office, it remains to be seen if he can get the various coalitions of the Senate to accept his interpretation of *D'era* and work together for the benefit of the Empire.

THE VICE-PROCONSUL

The vice-proconsul assists the proconsul in the actual day-to-day running of the Senate, and handles many of the minor details the proconsul may not have time to deal with personally. While some vice-proconsuls are quite content to serve in a secondary role, most see the office as a step toward becoming proconsul themselves. Many proconsuls have served as vice-proconsul in their time, and the job makes a traditional stepping stone to the highest office in the Senate.

When the vice-proconsul belongs to a different coalition than does the proconsul, as is currently the case, the vice-proconsul serves one additional purpose. He keeps watch on the proconsul and helps to keep him in check, looking out for the interests of the vice-proconsul's own coalition to see that the proconsul doesn't

THE DEFECTION OF M'RET

In 2369, Vice-Proconsul M'ret defected to the Federation, along with two of his aides, with the assistance of Ambassador Spock and the Romulan underground (see page 33). The defectors were placed in stasis inside a cargo container aboard the Romulan warbird *Khazara* for transfer to a Corvallen freighter. Although the plan was not entirely successful, M'ret and his aides were later transported aboard the Federation starship *Enterprise-D* with the help of Counselor Deanna Troi, posing as a member of the *Tal Shiar*.

M'ret's defection dealt a serious blow to the Romulan government and represented a major achievement for the underground. The appointment of a new vice-proconsul and the subsequent political upheavals can form the basis for many different storylines set during this time.

compromise them. Such an arrangement usually happens when two coalitions form an alliance to share power in the Senate and shut out other, smaller coalitions, as is now the situation with the Jaridan and Nej'ahar Coalitions.

Vice-Proconsul Louris actually has more experience as a senator than Proconsul Kota, but senatorial suspicion of the Jol Tan Coalition prevents him from overawing the young Kota. Kota had originally aligned his faction with the Nej'ahar, but the defection of Vice-Proconsul M'ret badly damaged the Nej'ahar Coalition and forced Kota to rank himself openly with the *Tal Shiar*. Romulan politics is still in a state of flux, and no senator knows what new coalitions will spring up in this time of new foreign adventurism and tension abroad.

Romulan Subjects

The Romulan Star Empire has a population in the trillions of intelligent lifeforms, scattered across numerous star systems. Many of these citizens are Romulan, but many more are species conquered or absorbed by the Romulan Empire.

THE ROMULAN ARISTOCRACY

The families listed below represent just a few of the prominent families in Romulan society. Some can trace their history to the earliest days of Romulan history, to the time of Tellus, or that of Emperor Valkis I. Others rose to prominence more recently, capitalizing on the exploits of one member who founded a new dynasty. These are the scions of Romulan society, those who wield considerable power and influence. They produce the Empire's senators, governors, diplomats, military leaders, and scientists. Considered paragons of Romulan society, they help determine the fate of the Romulan Empire and uphold Romulan tradition. They, more than anyone else, must emulate the Romulan ideal, for to do less would bring shame on those heroic ancestors who built the Empire.

BAREL

The Barel family can trace its history to the time of Tellus, and once ruled over the Lagona Segment, a small province on Romulus. To this day, they represent this province in the Senate, through the family patriarch, Senator Tomek, and hold additional Senate seats repre-

senting several colony worlds. Most family members belong to the Jaridan Coalition. Members of the Barel family focus their efforts in the political arena, obtaining positions as senatorial aids, diplomats, and regional governors, though some go into military service (where their political savvy benefits as well). They deeply resent political upstarts like the Gaius and Kassus families.

GAIUS

The Gaius family can make no grand claims to history, unlike the Barel family, and this is a source of friction between the two. The family rose to prominence through the efforts of Rombion, a centurion with a distinguished career of military service. The Romulan Senate rewarded him with a Senate seat, and since then the family has used the position to build a political base. The Gaius family has chosen to forsake its military heritage in favor of politics, their children learning to navigate the labyrinthine nature of Romulan politics at an early age. Admiral Vental commands the fleet of his cousin, Senator Aret, and the two make a formidable team.

KASSUS

The ancestors of the Kassus family fought many glorious battles in the Praetor's name, bringing Devorren and Pallor into the Romulan fold. While the family holds a seat in the Senate, members typically concentrate on military service. Children receive early training in warbird command, usually at the elbow of an experienced aunt or uncle. The family counts numerous admirals and centurions among its ranks. Senator Morrur Kassus is the current head of the Kassus family, having propelled himself to a Senate seat after a long, illustrious career. Some in the Senate fret over Kassus' ultimate ambitions, notably Senator Tomek.

KAYTON

Tracing its lineage back to the original settlers of the Romulan homeworld, the Kayton family possesses great moral authority, but little concrete political power. The oldest living member, the Doge Teret, wields considerable influence behind the scenes, and a succession of Praetors and proconsuls have privately sought her advice. Kayton family members prefer to work behind the scenes, expressing their opinions with a quiet word in the proper ear. Consummate power-brokers, members of this family trade in favors to achieve their objectives. From childhood, all Kaytons learn what it means to be "Romulan" and are held to a strict standard by their parents. The Gaius family currently courts this family to gain legitimacy.

MARRUS

While the Marrus family lacks a Senate seat, its members have carved out a niche for themselves as scientists and merchants. They derive great wealth, and thus influence, from their economic endeavors. A Marrus led the project to develop the quantum singularity drive, and holds the construction contract for it. The family manages several factories for the production of disruptors, magnetic constrictors, and isolinear chips. Those who do not become research scientists go into business; Marrus family merchants unite many Romulan worlds in trade. Well known members include Kolar, an intercessor and family head, and Sukkur, who oversees contracts with the Romulan military.



QELLAR

The origins of the Qellar family's prominence can be tied to one event: The family patron was the first chairman of the *Tal Shiar*. Since then, the Qellar family has derived its influential standing from its connections with the Romulan secret police; few openly oppose this family, for fear of attracting unwanted attention. Most Qellars join the *Tal Shiar*, and even those bound for a career in the military or politics are believed to have ties to this organization. Though few would express it publicly, some believe the Qellar family uses this relationship for personal gain. Ultraconservative, they have little use for, and even less admiration for, the Kayton family, whom they see as little more than social gadflies.

TELA

Once ruling over vast tracts of land early in Romulan history, the Tela family derives its stature from the ancestral holdings. Upon its arrival from Vulcan, the Tela family established a small fiefdom, from which it conquered neighboring territory during the period of clan wars. When Valkis I established the Romulan Senate, the Tela family received the largest bloc of seats. Over the years, through Senate appointments, the family lost all but one of its Senate positions, though it retains ownership of the land. Those family members who do not go off to the military manage the family's farms. The current leader of the family, Senator Chatak, serves as consul of the Nej'ahar Coalition.

TERIK

The Terik family gained prominence during the invasion of Romii, and many members distinguished themselves conquering the Zelvorians. Since then, members of this family have concentrated on military service. While the Kassus family grooms its children for eventual positions as ship commanders, the Terik focus on training in the art of war. They learn to fire a disruptor and engage in intense physical training at an early age. Admiral Nakhon received an appointment to the Senate for his support of Valkis during the Romulan Civil War, but few of his descendants have the stomach for political life. They have a reputation for being "uncultured," instead preferring a soldier's life.

THE ROMULAN PEOPLE

The first citizens of the Romulan Empire are the Romulans themselves. With their philosophy of *D'era*, the Romulans consider it their destiny one day to rule the galaxy. Every Romulan, no matter how humble, knows that he is special simply by virtue of being born Romulan. The Romulan people have a destiny, a special place in the universe by virtue of their Vhorani ancestry.

The average citizen is proud of the Empire's achievements, of its long and noble history. Ancestors are honored for their achievements and the Praetor is considered the living embodiment of Romulan virtues. All citizens aspire to serve the Empire with honor and distinction and, perhaps, to rise above their lot in life and reach toward that elusive quality known as glory.

Still, most Romulans know their place in life. They live much as their forebears did and teach their children to do likewise. Those who are tradesmen will likely continue to be tradesmen, those families who belong to the military tend to stay with the military, and so forth. Romulan life remains dependable and orderly. The great families of the Empire turn out senators, generals, and admirals, and that is as it should be. Greatness is rewarded; failure and disloyalty are punished.

True Romulans are loyal to the empire. In fact, they tend to proclaim their loyalty loudly and often, just in case there might be someone listening. Being watched and monitored by the *Tal Shiar* is a daily fact of Romulan life. The greatness of the Empire is paid for in vigilance against those individuals who would betray their heritage and bring shame upon their families by committing treason.

So the average Romulan citizen is content, knowing the Empire is great and powerful and confident in its leaders. There will always be those dissatisfied people who seek to change the status quo, but the authorities and the ever-watchful *Tal Shiar* generally keep them under control.

THE PUBLIC ASSEMBLY

The Romulan Star Empire is a republic, giving its citizens a voice in how they are governed. Although the Senate has supreme power and appoints its own members, there is a public body giving voice to the needs and concerns of the common

people: the Public Assembly. Senators place considerable emphasis on the opinions of the Public Assembly because they reflect the opinions of the Romulan people, and popular support is often a critical element in Senate decisions. Senators know full well they govern at the sufferance of the people, and many are genuinely devoted to serving as true representatives of their constituents.

Technically, the Public Assembly is the entire population of the Romulan Star Empire; every citizen—even non-Romulan citizens—has a voice that can be heard. For all practical purposes, however, the Assembly is limited to representatives chosen by popular vote to voice the concerns and interests of their constituents to the Senate.

Once again, Romulan worlds have more representatives to the Public Assembly than alien client states, and older worlds have more of a voice than newer, younger colonies and member states. The Senate tends to be most concerned with the opinions of citizens close to home, on Romulus and Remus, than with the central colony worlds and finally with the outer reaches and client states.

PLANETARY GOVERNORS

A planetary governor appointed by the Senate administers each world in the Romulan Empire. The governor answers to the senator representing his province, who brings any concerns or issues before the Senate for consideration. Planetary governors are always Romulans, even on client worlds conquered or absorbed by the Empire long ago.

A planetary governor has broad discretionary powers in handling local affairs on his world, but must answer to the Senate if there is trouble. Governors have a strong interest in maintaining order, discipline, and productivity on their worlds to ensure their positions, since the Senate can remove any planetary governor who does not meet with its approval. Otherwise, a planetary governor serves until he chooses to resign his position. Many senators start out as governors and retain a network of contacts and friends on the worlds they have governed.

CLIENT STATES

Although the Romulans have numerous colonies and settlements throughout their space, they make up only a portion of the population of the Romulan Star Empire. The rest of the Empire's population is made up of other alien species. Most of these species have been conquered and their worlds absorbed by the Romulans. Some have entered into peaceful treaties with the Romulans, either out of fear of being conquered or a desire to join the Empire and gain the benefits of military protection and economic support. Worlds along the Klingon/Romulan border have been particularly willing to join the Romulan Empire in order to avoid the oftentimes brutal rule of the Klingon Empire. While not as egalitarian as the Federation, the Romulan Empire is known for treating its client states fairly and well.

The Romulans view the fair treatment of their clients as part of *D'era*. Since it is the duty of the Romulan species to rule the stars, they have an obligation to treat their subjects well. The Romulans feel a responsibility to their client states and do their best to ensure they are peaceful and prosperous. Members of client states are considered wards of the state, entitled to limited protection and privileges under Romulan law. Client worlds are sometimes allowed to retain a small planetary militia or police force, made up of loyal, naturalized citizens, and to construct and maintain ships for the pur-



poses of trade and transportation, but all other military resources are strictly the provenance of the Empire.

Existence under Romulan rule varies widely for different client states. Those clients who submit to the rules and requirements of the Empire are allowed to live fairly pleasant lives, albeit restricted in matters of trade and government by the edicts of the Romulan planetary governor. Those client worlds most recently conquered, or those which remain hotbeds of rebellion, are subject to harsh, draconian laws, planetwide curfews, military patrols, and so forth. As a general rule, peaceful client states are allowed to mostly govern themselves. Those who resist the will of the Empire are crushed, as an example to others.

Diplomacy

For more than fifty years, the Romulan Empire had few, if any, diplomatic relations with other civilizations in the Alpha Quadrant. After the Tomed Incident, the Romulan ambassador to the Federation was recalled to Romulus and only silence was heard from the far side of the Neutral Zone. The Romulans spent those years handling internal matters and dealing with the Taurhai.

In 2364, the Romulans emerged from isolation to investigate the disappearance of several of their bases along the Neutral Zone border. This brought the Romulans back into contact with the Federation and other interstellar powers. The Romulans returned to the game of interstellar brinkmanship with considerable zest, and are currently a major player among the civilizations of the Alpha Quadrant.

UNITED FEDERATION OF PLANETS

The Romulans see the United Federation of Planets as a deeply flawed civilization. It is predicated on the gathering of knowledge for its own sake, exploration, mutual defense, and the equality of all intelligent species. More importantly, the UFP is devoted to an ideal of noninterference in other societies that limits

CITIZENSHIP

For members of those species integrated into the Romulan Empire, citizenship is a reward that must be earned. While the Empire treats the inhabitants of its client states fairly, they do not have the same standing as a full-blooded Romulan. Clients enjoy protection under Romulan Right of Statement, but they are not given equal standing under the law. They may own property, but must obtain permission to travel and may not vote in the Public Assembly. Romulan subjects may not bear arms, nor serve in the military or government, nor participate in Romulan religious rights. There is one exception to this: The *Serona* rite, which is performed when an alien subject professes a strong desire to be a citizen of the Empire. Otherwise, the Empire views its clients as children to be safeguarded, until they are ready to accept Romulan rule and join Romulan society.

Many subjects aim to become citizens of the Empire, with the full rights and responsibilities of a native Romulan. The government rewards non-Romulans with citizenship for service to the Empire, typically after *Serona* service. Regional governors, admirals, and senators may grant citizenship at their discretion, similar to a promotion in the field for a military officer.

Those granted citizenship undergo the *Pylanazi*, affirming their allegiance to the Empire, and may then participate as full members of Romulan society, including military or government service; they may adopt a Romulan name, marry under the *So'rdaz*, and obtain a *Charozzah*. Only those who earn citizenship may participate in the Public Assembly. The Empire often posts naturalized citizens to the planetary militia or regional government of their homeworlds. Those who return home proudly wearing a soldier's uniform or as a government official serve as a shining beacon to others of their kind. They attest to the benevolence of the Romulan Empire and to the rightness of *D'era*.

their expansion and their influence. The Federation is clearly tainted by the teachings of Surak and Vulcan ideology. This is not surprising, since Vulcan is one of its founding members.

Everything the Federation stands for runs counter to the Romulan ideal of *D'era*. The Federation believes all species are created equal; the Romulans know they are not. The Romulans are destined for greatness and the Federation stands in the way of that destiny. The Romulans, however, remain unconcerned. To them, the Federation is a weak and corrupt civilization. Its democratic method of government is akin to chaos, and its own code of ethics paralyzes it, preventing it from acting in situations where the Romulans would do so without a second thought.

Still, the Federation is not an easy adversary. Their war against Earth taught the Romulans some respect for humans as adversaries, and Starfleet is still a formidable military force. Rather than simply go to war with the Federation, the Romulans prefer to probe for weakness, testing the defenses of their enemy and trying to provoke the Federation into making a fatal mistake that will finally bring about a collapse of its civilization, allowing Romulan forces to sweep through. Every Romulan knows it is only a matter of time before the Federation falls, and they're willing to be patient.

VULCAN

A great deal of the Romulan disdain for the UFP comes from the fact that Vulcan, the ancient homeworld of the Romulan race, is one of the founding worlds of the Federation. Vulcan ideas of peace, logic, learning, and democracy are clearly visible in the Federation Charter, things that caused the ancient Romulans to leave Vulcan when Surak's philosophy of logic became the dominant view. Because the Vulcans turned their backs on their Vhorani legacy, the Romulans consider their Vulcan cousins at best sadly misguided. At worst, Romulans detest Vulcans for their cold and disdainful manner and for the smug, silent superiority of Vulcan logic. Something about the way Vulcans carry themselves is like a challenge to a Romulan, as if to say the Vulcans were the victors in their ancient conflict, that their doctrine of logic makes them superior, when it only makes them weak.

Despite this, some Romulans believe in the possibility of a reunification of their race and the Vulcans. Most think the Vulcans will realize their mistake in joining the Federation when that civilization falls. They will choose to join the Romulan Empire and take up the ancient ways of their ancestors. A small but growing minority believes the Vulcans were right to reject war, and that the Romulan people can learn important lessons from them. Such views are considered treasonous, and those who hold them often find their way into the reunification movement (see page 33).

KLINGON EMPIRE

Although worthy adversaries in battle, the Romulans consider Klingons their inferiors in every other way. The Klingons are brutal, bloodthirsty, and savage. They lack the intelligence and insight of the Romulans, and their childish code of bravado traps them and makes them easily manipulated. For a time, the Romulans were forced to ally with the Klingons against the Federation, but they never considered them equals.

That the Federation apparently does is an endless source of amazement to the Romulans. The alliance between the Federation and the Klingon Empire is an obstacle to Romulan plans for expansion, and the Romulans have devoted themselves to doing everything they can to destroy it. The Romulans prefer to use subterfuge to provoke either side into ending the alliance. These tactics are usually aimed at the Klingons, since they are more emotional and easier to manipulate. The attempted assassination of Klingon Governor Vagh in 2367 and the Romulan support of the Duras Family during the Klingon Civil War are two prime examples of such plots.

CARDASSIAN UNION

There is much the Romulans admire about the Cardassians. Their civilization is founded on many of the same ideals as those of the Romulan Empire: honor, duty, loyalty, and conquest. Of course, the Cardassians lack the ideal of *D'era*: Their society is the result of hardships they have faced in the past and not a grand destiny. Still, the Romulans understand and respect the Cardassians far more than they do the weak-willed Federation or the savage Klingons.

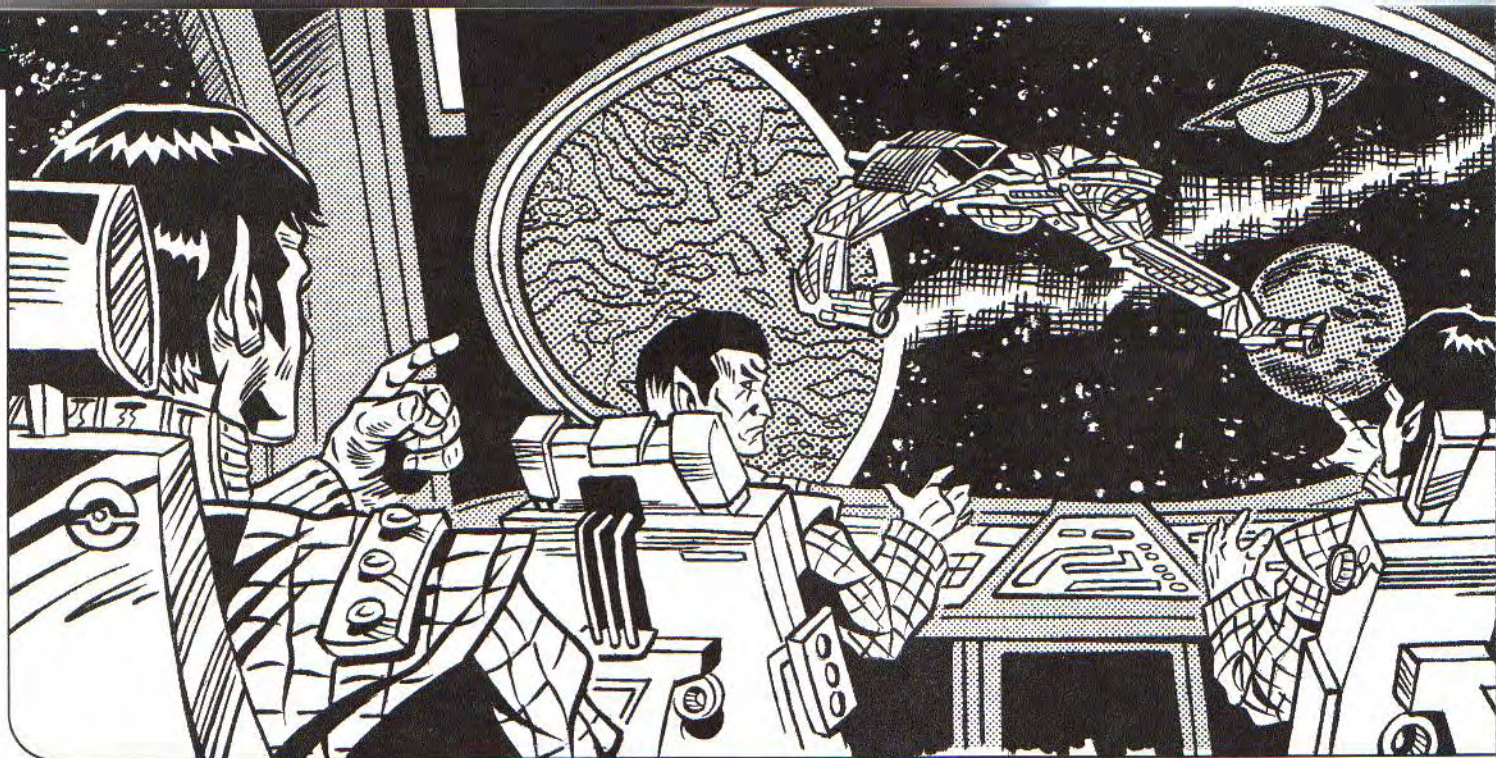

The two empires have little direct contact, because the Romulans see the Cardassians as rivals for galactic domination. Many Romulans believe that the fate of the Alpha Quadrant will eventually come down to a conflict between the two empires once the Federation/Klingon alliance has fallen. In the meantime, the Romulans consider the Cardassians potential allies against their mutual enemy, the Federation.

FERENGI ALLIANCE

Romulans content themselves with the thought that they could conquer the Ferengi virtually overnight, if they wished. For now, the Ferengi serve a purpose: transporting and selling weapons, supplies, and materiel to support Romulan activities throughout the Alpha Quadrant. They are a neutral third party the Romulans can work some of their schemes through and at the same time maintain as a trade pipeline to systems outside their space.

Ferengi merchants are allowed passage through Romulan space, and hold several lucrative trading contracts for Romulan worlds. However, the Empire carefully limits the trading power of the Ferengi to prevent them from becoming too influential in the Romulan economy. They know full well that becoming dependent on the Ferengi for anything is a dangerous weakness. The Ferengi, for their part, push for expanded trading agreements, but not so forcefully as to risk angering the Romulans.

BORG COLLECTIVE

Possibly the greatest threat the Empire has ever seen, the Romulans are very concerned about the Borg, although they never allow their concern to show. The Romulans know precious little about the Borg. They have evidence of Borg attacks at several posts along the Neutral Zone and at three Romulan colonies established near the borders of the Delta Quadrant, which they believe to be the home space of the Borg Collective.

Thus far, all Romulan contact with the Borg has resulted in no survivors to provide any information whatsoever. The Borg efficiently capture or destroy all personnel and technology in the areas where they

attack. Garbled transmissions from ships, outposts, and colonies that have encountered the Borg are all the Romulans have to go on, and what they've seen deeply concerns them. The Borg appear to be a force even more dangerous to the Empire than the Taurhai (see page 21).

The Romulans are so concerned that they are even willing to consider a temporary agreement with the Federation/Klingon alliance for the purposes of mutual protection. The Romulans know they can deal with their Federation and Klingon neighbors at some point, but they are not so certain about the relentless, mysterious Borg. They are eager to gain access to whatever information the Federation currently has regarding the Borg.

Voices of Dissent: The Reunification Movement

This section is intended as an optional one for Narrators. It describes a growing reform movement within the Romulan Empire that becomes known to the Federation in 2368, following the arrival of Ambassador Spock on Romulus. It is included here for Narrators who wish to explore the ramifications of the movement, either before or after Ambassador Spock's arrival. Since the movement remains quite small and scattered, even up to the involvement of Spock, it can easily be ignored by Narrators who do not wish to include it in their games.

HISTORY

Not all Romulans are pleased with the current state of imperial affairs. Although most Romulans are raised on loyalty and obedience to Empire and Praetor, some began to question this. In particular, the hardships imposed by the needs of the Romulan military and the constant vigilance of the *Tal Shiar* raised questions in the minds of Romulans who sacrificed family members and loved ones to the greater glory of the Empire. These people began to wonder why their loved ones should die in conflict with another race near a faraway star, or why they should be arrested and executed for speaking their minds.



In time, these questioning individuals managed to find each other. They gathered together secretly in small groups to discuss their feelings and concerns, and to debate issues of politics and policy. Some went no further than discussions, while other groups of dissidents found themselves driven to act on their beliefs to try and effect change within Romulan society. Those who did so publicly or openly were quickly arrested and charged with treason. Others wisely worked behind the scenes, seeking to make change slowly, gathering support and influence wherever they could. Over time, the reform movement grew strong enough for the Romulan government to take serious notice of it and, in true Romulan fashion, they decided to turn it to their own advantage.

AMBASSADOR SPOCK

A decorated Starfleet officer and honored Federation diplomat, Spock of Vulcan has long held out hope for some kind of peaceful accord between the Federation and the Romulan Empire. When his old friend Senator Pardek contacted him regarding a possible reunification proposal in the Romulan government, Spock could not turn down the opportunity to go to Romulus and negotiate the agreement. He left Federation space without so much as a word to anyone, since secrecy was paramount in handling the delicate negotiations.

Naturally, Spock's disappearance greatly concerned Federation officials, as did his sudden appearance on Romulus. Starfleet undercover agents were dispatched to make contact with Spock, learn if he had defected to the Romulans, and bring him back if necessary. These officers managed to thwart a secret Romulan plot to invade Vulcan with Spock's inadvertent help. Ambassador Spock chose to remain behind on Romulus in order to assist the nascent reform movement.

Since that time, he has become the movement's reluctant leader and guru, much to his own chagrin. Spock prefers to lead through example, but most of the members of the underground treat his "suggestions" as gospel. Many revere Spock as an example of the Vulcan ideals from which the ancient Romulans turned away, a living link to a heritage most Romulans have only heard about, in stories passed down in secret from their ancestors. This is certainly ironic, since the Ambassador is half-human, although he chose a Vulcan way of life. It is perhaps Spock's struggle with his human half that allows him to understand his Romulan counterparts far better than a pure Vulcan would.

Ambassador Spock has the difficult task of unifying the many scattered and disparate factions of the reunification movement, some of which do not share the same goals or ideals. A man of peace, Spock is firmly opposed to the use of violence as a means of effecting political change. He does his best to curb the violent tendencies of the Romulan dissidents and to limit the activities of those factions who advocate terrorist methods. Once again, Spock tries to teach his Romulan followers through logic and example, citing tales from ancient Vulcan history when issues of violence caused the original split between the Vulcans and the Romulans. He counsels those in the underground against repeating the mistakes of the past. If they truly desire reform, they cannot do so using the tools of those things they wish to change.

Most importantly, Ambassador Spock carefully avoids taking too strong a hand in shaping events on Romulus. Although most of the dissidents revere him and hunger for a leader, Spock wants solutions to come from within Romulan society, not to be imposed by an outsider like himself. A firm believer in Federation ideals of freedom of choice, he knows that for the dissidents to achieve meaningful, lasting change, it must grow from their own work and their own ideals.

The Romulan authorities are well aware of Spock's presence on Romulus, and *Tal Shiar* agents do their best to track the Ambassador's movements. By the same token, Spock is aware of their surveillance, and does his best to avoid detection and to keep the identities of key members of the underground a secret. Although the *Tal Shiar* could probably locate and detain Spock without much difficulty, they have avoided doing so, since Spock is a highly respected Federation diplomat and doing so could cause a major incident between the Empire and the Federation. Instead, in typical Romulan fashion, the *Tal Shiar* watches and waits for Spock to make a mistake that will allow them to charge him as a spy and a terrorist, giving the Romulans clear reason to act and embarrassing the Federation in the process. Spock has been careful not to give the authorities any such excuse, all the while helping the dissidents behind the scenes.

ORGANIZATION

The rebellion is organized into "cells," small groups of individuals (rarely more than a dozen), often sharing a common ideology or interest, who meet secretly in private homes or isolated, out-of-the-way locations to avoid detec-

tion. A member of a rebel cell knows only the other members of his cell. In this way, a cell member can only betray the identities of a single cell if captured and interrogated by the *Tal Shiar*.

The leader of each cell maintains contact with the leader of a higher-ranked cell in the movement's hierarchy. Cell leaders report up the chain of command through higher-ranked cells to reach the central cells, which are in contact with Ambassador Spock and the central leaders of the movement. Such communication is slow and inefficient, but protects the individual cells from easy detection and arrest by the Romulan authorities.

Tal Shiar agents regularly attempt to infiltrate rebel cells, or to co-opt rebel communications by sending false messages disguised as legitimate information coming from another cell. The rule of thumb within the Romulan underground is to trust no one, except for close personal friends. Under the influence of the *Tal Shiar*, even close friends have been known to turn on one another. Although they have made successful strikes against the rebel movement, the *Tal Shiar* remains far from eliminating it, since for every cell they manage to infiltrate and eventually destroy, another seems to spring up somewhere else. The rebels also have a few allies within the Romulan government, allowing them to mislead the *Tal Shiar* from time to time.

Although the reform movement continues to grow, its cellular organization sharply limits its effectiveness for now. Individual cells are largely ignorant of the activities of others, so coordinated action on the part of the movement takes considerable time and planning, usually time enough for the *Tal Shiar* to learn of a plan and take measures to thwart it. For the time being most reform leaders, including Spock, advise cells to follow a program of quiet recruitment and keeping the fires of reform burning rather than overt action. This policy chafes many more proactive rebels, who desire immediate action.

ISSUES

The Romulan underground faces several important issues which might decide the fate of the movement as well as that of the Romulan Empire itself, depending on the rebels' course. Ambassador Spock does his best not to influence the Romulans' decisions on these issues, while still keeping them on the course he thinks will most likely lead to success and a lasting peace for the Romulan people.

The first issue faced by the dissidents is quite simple: What do they want? Everyone within the underground agrees that Romulan government and society must change, but there remains a lack of consensus as to how it must change. Each individual joins the movement for a different reason. It may be political ideology, personal resentment for the Empire and its government, the loss of a loved one in war or to the operations of the *Tal Shiar*, or any number of other reasons.

Likewise, each member of the rebellion has his own ideas about how the Romulan government should be reformed. Many think a more democratic system should be installed, similar to that of the Federation, with the people having a greater say in how they are governed. These rebels are split as to whether or not such a democracy should include non-Romulan members of the Empire or if the Romulan people should retain the strongest voice.

Other factions prefer some type of oligarchy controlled by a particular sociopolitical group to replace the old senatorial families, such as rule by the military, by a scientific elite, by political philosophers, or even by great



artists and poets who understand the nature of the Romulan spirit. A minority faction advocates a reinstatement of an emperor as supreme head of the Romulan state, or a strengthening of the Praetor's power at the expense of the Senate. A few dissidents are simply anarchists, advocating the downfall of all forms of government and complete freedom of choice for all people.

Some rebels hope for even broader changes in the Romulan political and social landscape, such as an adoption of more Vulcan traditions among Romulans and some kind of peaceful reunification of the Vulcan and Romulan peoples. Others seek a union with Vulcan, but without the loss of the unique cultural identity Romulans have developed over centuries of separation from their homeworld. There are even those factions which advocate the elimination or at least the reevaluation of the values of *D'era* in Romulan society. They question the right of Romulans to rule over the stars and suggest that focusing their violent tendencies outward toward other races will only lead to the Empire's ultimate downfall.

The second important issue, closely related to the first, asks what means are acceptable for the dissidents to bring about the changes they seek. Ambassador Spock advocates only peaceful means of effecting change within the Empire, particularly through social interaction, the spread of new ideas and philosophies, and passive resistance.

Still, the Romulans are a passionate people, and many rebels find such peaceful methods too slow or ineffectual for their tastes. They advocate terrorism and armed rebellion to force change. Such violent cells do little to improve the popular view of the reform movement, and they are regularly targeted by agents of the *Tal Shiar*, since they create the largest public outcry and provide the most spectacular triumphs for the Romulan authorities. More peaceful cells use the actions of the more violent minority as an effective "smoke screen," concealing their own activities from the *Tal Shiar* while they work quietly to effect change behind the scenes.

OPERATIONS

The major activity of any rebel cell, regardless of its political ideals, is recruitment of new members for the

cause and spreading its ideals to a larger segment of the Romulan population. The more members the reform movement gains, the more likely its dreams of change become, putting its members one step closer to popular acceptance of their ideas and a voice in Romulan society.

Rebel cells recruit with the utmost care, since the *Tal Shiar* regularly tries to place infiltrators into cells to spy on them and feed information back to the Romulan authorities before eventually betraying the cell and having its members arrested and interrogated. Cell members carefully watch for signs that someone might hold ideals similar to their own. If they find such a person, they evaluate the potential dangers of contact with their fellow cell members. If the danger is judged worthwhile, a cell member initiates contact and begins to feel out the potential recruit. Usually this begins with fairly innocuous questions about beliefs and experiences, then grows into a discussion of things considered treasonous by the Romulan government. There is always a risk that the contact will turn the cell member in to the authorities, or turn out to be an undercover *Tal Shiar* agent.

If this doesn't happen, then the recruit is slowly introduced to the other members of the cell and their ideology. Often, some kind of test or initiation is required of the new recruit to prove his loyalty to the movement and to help assuage any concerns about the recruit being a spy. This might involve some kind of telepathic contact, although skilled telepaths are extremely rare in the rebellion. More likely, it involves the commission of some act of treason or rebellion against the Empire, which commits the recruit to the rebellion. It is usually some time before a new recruit completely wins the trust of the other cell members.

In addition to recruiting Romulans, some rebel cells also seek to cultivate allies elsewhere. For the most part, this involves making contact with members of Romulan client races and trying to recruit them. This is a point of some contention for members of the underground, since some consider the matter an entirely "Romulan" issue that should not involve outsiders. Others—usually democratic reformers—believe that all races within the Empire deserve a say in how it is governed and an opportunity to air their grievances against the government.

Many cells do little beyond recruiting. The cell meets regularly in the home of a member or in some secret meeting place concealed from the prying eyes of the authorities. There they discuss political and social theory and philosophy, pass information on to other cells in the underground, and hear news about the activities of other cells and information the Romulan government tries to keep from the general populace. They then return to their normal lives and do their best to conceal their sympathies, until a new potential recruit comes along.

The resistance would very much like to gain the assistance of other interstellar powers like the Federation, but it is virtually impossible for them to do so, given the restrictions they operate under. Still, information is occasionally smuggled out of Romulan space into the hands of Federation agents, where it can be used to curb the growth of the Empire and help to prevent another war. The Federation is technically forbidden to interfere with the internal affairs of the Romulan Empire, but it quietly encourages the reform movement by using the information and aiding Romulan defectors, along with turning a blind eye toward the activities of Ambassador Spock on Romulus.

Some cells are more active, planning and executing activities aimed at undermining the Romulan government and strengthening the rebel movement. Nearly all of these activities are planned and carried out in secret, since the movement does not have the support or resources to carry out public protests of any kind without risking immediate arrest by the Romulan authorities.

Instead, some cells plan the theft of information from the authorities that supports their claims: publishing sensitive or embarrassing information about Senate and military activities, stealing secret military or research documents for use against the government, and generally spreading rumors and information the government tries to keep secret. In some cases, rebel cells act as spies for other nations like the Federation, passing on knowledge of Romulan military and espionage operations in order to weaken the government.

Other cells carry out actual terrorist activities against the Romulan Empire. These range from the fairly nonviolent, such as the sabotage of the Romulan Information Network using computer viruses or pirate broadcasts, to the destruction of Romulan governmental and military buildings and resources using explosives and similar weapons. Such violent activities are denounced by more peaceful cells, and generate the greatest public anger toward the dissident movement. The Senate and the *Tal Shiar* use terrorist incidents to point out how dangerous the dissident movement is to the general public and to call for increased spending on military and security resources for stronger crackdowns on all rebel activity within the Empire. This has caused more cynical dissidents to fear that the *Tal Shiar* actually orchestrates the actions of supposedly "radical revolutionaries."

THE RAPTOR'S TALON



From the farthest corners of the Iridion Belt to the spinward sectors near the Empty Frontier, from the core worlds bordering Federation space to the tumultuous regions along the Taurhai border, the Romulan Star Navy represents a rare constant in the dynamic and often unpredictable politics of the Romulan Empire. The Navy and its numerous command and senatorial fleets embody—perhaps more than any other element of Romulan culture—the militant spirit that burns at the heart of *D'era*.

While the primary missions of Starfleet remain distinctly nonmilitary (exploration, relief, research, etc.), by contrast those of the Star Navy assume a considerably more martial profile. The Romulan Star Navy is a true military force in every sense, its principal missions those of conquest, pacification, and war. As a result, much of the Empire's infrastructure remains geared toward the support of the Navy and the long-term needs of the Star Command.

In fact, the Star Command relegates exploration and scientific missions to second-tier status, handled exclusively by the Exploration Command. Treated almost as an independent entity within the larger organization, Exploration is considered a lesser sister to the more prestigious military postings. Among some of the more aggressive coalition and senatorial fleets, transfers to exploration, research, and first-contact tours have become punishments for unsatisfactory performance.

Although Naval recruits are drawn from across the Empire, many fleets retain distinctly "regional" flavors. In an Empire where true loyalty can be worth its weight in latinum, officers and soldiers from the core worlds are more highly prized than those from outlying sectors or client states. This creates something akin to a "free market" atmosphere when the Star Command places young cadets during their *Serona*, with senators and coalition members jockeying to place their favorite sons in key fleets or positions.

The result has been the creation of a very political fleet, although one which never fails to place the ultimate welfare of the Star Empire and its citizens above all else. While lesser allegiances shift daily among the far-flung senatorial units and outlying command bases, such fluid personnel dynamics actually strengthen the Navy's overall resolve and effectiveness. This is something potential enemies, including Starfleet, have long failed to understand—that such posturing and political grandstanding does not erode the Navy's effectiveness. In fact, the opposite seems to be true—such maneuvering goes to the very heart of *D'era* and strengthens it, reminding both officer and senator alike of the ancient tradition of which each is a small part. All members of the Navy, no matter how insignificant, remain part of this grand expression of Imperial ideals, carrying the standard of the Empire against all who would offer resistance.

Star Navy Organization

While on the surface the organization of the Star Navy may seem to parallel similar organizations of other cultures, it is in fact a very different animal. Certainly, the Navy possesses the normal rank and operations structures one would expect to find in such a vast hierarchy, but the loyalties of the rank and file are often directed in multiple and unexpected ways.

The loyalties of an average Starfleet officer are relatively clear-cut by comparison: A Starfleet commander is loyal first to his captain, then to Starfleet Command, and finally to the UFP as a whole. The hierarchy

remains a firm and well understood progression. Not so in the Star Navy. A Romulan centurion is loyal to his fleet and his Empire, but he may have additional political or coalition loyalties as well. In certain cases, a centurion may even have to defer to an unusually well connected junior officer on his own vessel.

As a result, most centurions quickly become adept politicians, able to play numerous loyalties and favors off of one another to gain the greatest personal benefit in the end. It is no surprise, then, that many Romulan senators began their careers in the Star Navy. While the paranoia this system engenders may appear counterproductive to opposing powers, the Romulans take the converse view—a watchful officer is a strong officer, and if his loyalty isn't absolute, that may be a necessary casualty of the system. At least he's being carefully observed.

FLEET ORGANIZATION

The Romulan Star Navy is divided into various fleets, each under the nominal control of the Star Command. Unlike the purely organizational divisions present in Starfleet, Romulan fleets embody political, and in certain cases philosophical, divisions. They often represent semiautonomous and self-sufficient operational commands of their own.

Each fleet owes its *D'artat* ("First Loyalty") to its own *Ar'nal* ("First Among Equals"). The bonds of *D'artat* run deep, and Imperial history is rife with examples of such loyalty superseding all else. *D'artat* can be directed at a group or organization, but it most often manifests itself in the form of individual leadership. Because of this, most fleets break down along lines of factional loyalty, with a single strong figure standing alone (to outside appearances, at least) at the head. Most Romulan fleets fall into one of several broad categories—Command, Senatorial, Coalition, or Praetorian. Certain "special" fleet types exist, as well.



Just as Romulan ground forces are divided into legions, fleets are divided into *Avara* ("Centuries"). A century normally includes approximately one hundred vessels, along with the attendant support craft necessary to maintain the fleet's peak operational status. Of course, such numbers represent optimal figures; the reality depends on the current status of the fleet itself, and can be influenced by a myriad of outside factors: the standing of the fleet's *Ar'nal*, the latest resource constraints at the Star Command, any outstanding favors owed by the High Tribunal, any current coalition relationships, etc.

In recent years, the concept of the "century" has gone out of favor with many younger and more progressive commanders and senators, slowly becoming more an outdated tradition rather than an established fact. Emphasis within many of the newer fleets has shifted to make room for larger numbers of small incursion vessels and quick frigates, vessels strong in firepower and stealth but weak on personnel requirements and maintenance drain. Knowing a fleet consists of "two centuries" worth of vessels means very little in the 24th-century Star Navy; understanding a fleet's current standing gives a potential adversary a much better gauge of the unit's effectiveness and strengths.

Just as Starfleet's various fleets are responsible for specific sectors or regions of space within the Federation, Romulan fleets accept specific regional assignments from the Star Command. Unlike Starfleet, however, fleet assignments in the Star Empire tend to come with significant political undertones. A powerful senatorial fleet might be banished to an outlying frontier sector by a weak Praetor, while an understaffed coalition fleet might call in a favor from a Tribunal member to gain its station along the Neutral Zone. The maneuvering among the fleets for posting and station is never-ending, and serves as an appropriate reflection of the prevailing tides of influence within the highest echelons of Imperial power.

Certain fleet stations remain unchanging: The Praetorian Fleet is always stationed on Romulus (with smaller detachments and outlying bases placed on other strategic worlds throughout the Imperial core), and other fleets are not permitted to enter the Imperial home system. Aside from a few exceptional years under extremely popular Praetors, the fleet of the ruling coalition (currently the Jaridan Coalition) is stationed wherever the coalition wishes. The current Jaridan Fleet consists of three centuries numbering a little more than 300 ships, two of which are currently stationed along the Federation Neutral Zone.

Other fleets are generally stationed according to the political roll of the dice. Most senatorial and coalition fleets are given assignments in or near the home regions or provinces of their supporters. Of course, political favor can play a crucial role in such postings—a key assignment to a trouble spot can elevate a poor senator or upstart coalition to a position of great power in the Empire, while an exploration posting can weaken a sponsor's power.

Finally, the ultimate balance in this great game takes the form of the various Command fleets. Normally above the traditional military politics found throughout the other fleets, the Command fleets remain under the direct supervision of the Star Command and the High Tribunal. For this reason, these units are normally posted to the most sensitive or crucial regions of the Empire. While these assignments are not truly considered permanent, the three Command fleets near the Taurhai bor-

der have been patrolling the Tullus Sector long enough to become known as the "Tullan Three."

THE FLEETS

COMMAND FLEETS

The core forces of the Star Command, the various Command fleets form the bulwark of the Romulan Star Navy. Although under the control of the High Tribunal, and thus the Praetor, sometimes these fleets become political pawns, their missions and loyalties shifting along with prevailing political winds. A strong Praetor can secure a degree of control from the Star Command; a weak Praetor cannot, and is often forced to coexist with powerful flag officers and their personal ambitions.

When an outsider thinks of the Romulan Star Navy, chances are he is thinking of a Command fleet. This is only natural—since these units are generally assigned to sensitive regions and frontier duties, nearly every outside or hostile encounter with Romulan vessels has involved ships from one of the Command fleets. In fact, for many years Starfleet thought that these fleets were the only Romulan vessels in active service (Starfleet Intelligence eventually proved this notion false).

There are currently twenty-one standing Command fleets in the Romulan Star Navy, each of which is traditionally composed of three centuries. In practice, the fleets never adhere to these numbers, more out of practicality than an inability to do so. Because of their nature as threat response and patrol units, most Command fleets are split into "command wings" during normal operations, with each wing commanded by a "wing-ship." In addition, the fleets stationed far from the Imperial core (such as the 4th Othan Fleet) tend to be larger than those headquartered closer to home.

SENATORIAL FLEETS

Since many senators achieved their positions through military service, as a reward for their achievements, they continue to retain their ties to their former fleets. These fleets owe their allegiance to their former commanders first, becoming de facto senatorial fleets. Some have remained under the nominal control of a particular Senate seat for generations. The infrastructure of these fleets is not so much built as transferred, with senatorial houses and families passing their infrastructure and holdings down from one generation to another. When unique questions of succession arise, senatorial fleets are sometimes passed to other members of a prominent family's coalition.

Most senatorial fleets remain small, serving as a physical representation of their scion's power and prestige within the Imperial hierarchy. Only the fleets of the most powerful senators approach the grandeur of the Command fleets, and most senatorial fleets consist of only a single century. Consular fleets are often the exception, since they tend to benefit from the political and budgetary powers of their patrons. Consular fleets often become temporary or de facto coalition fleets as well. In the contemporary Star Empire, only the consular fleets and four senatorial fleets—those of Senators Sullan, D'mora, Kassus, and D'varo—boast multiple centuries.

COALITION FLEETS

Less common than senatorial fleets, coalition fleets are often temporary creations formed in times of crisis or



political upheaval (much like the coalitions themselves). In almost every case, a coalition fleet is composed of several senatorial fleets, or portions thereof. Most coalition fleets possess a higher than usual representation of legates, to assure smooth transitions among the various fleet command structures. Such fleets also attract more than the normal share of tribunes or tribunal representatives, since the peacetime massing of such forces tends to make the Star Command a bit nervous.

Only two of the most powerful coalitions—the Nej'ahar and the Jol Tan—maintain permanent standing fleets of their own. While some dissenters argue that the various fleets directly or indirectly allied with the Jaridan Coalition constitute a third coalition fleet, the Praetor and his supporters are careful to dispel this (probably valid) opinion.

PRAETORIAN FLEET

The naval arm of the distinguished Praetorian Guard, the Praetorian Fleet falls under the direct command of the Praetor. Its primary duties include escort and patrol missions throughout the Imperial core, and specifically in the home system of Romulus. A Praetorian escort is considered a high honor for visiting dignitaries, senators, or high-ranking military personnel. The fleet also accompanies the Praetor whenever he travels—together with the ground forces arm of the Guard, the Fleet is responsible for the safety of the Praetor whenever he leaves Romulus. In times of great celebration or victory, the Praetorian Fleet also bears the privilege of leading triumphal cruises through the home systems.

According to ancient tradition, the Praetorian Fleet is also the only fleet permitted to enter the home system of Romulus (all other fleets are anchored in neighboring systems or at nearby bases when stationed near the Imperial core). While this tradition is often waived during times of crisis, strong Praetors still enforce it even in modern times. According to traditional naval doctrine,



THE PRAETORIAN GUARD

The Praetorian Guard includes elements of Fleet, Planetary, Occupation, and Pacification Command units under a single, elite umbrella. Ships from the Star Command comprise the Praetorian Fleet (which has been discussed earlier in this section). Units of the Planetary Command (the ground forces) comprise the Praetorian Legions (traditionally six legions), and the Imperial Shrikes include the Praetorian Brigades.

Collectively, each branch of the Guard has pledged its undying loyalty to the Praetor of the Romulan Empire. Each of these divisions contains the best of the best, officers and soldiers selected both for their military ability and their loyalty to the Empire.

In practice, strong Praetors enjoy the full loyalty and commitment of their Guard units, while weak Praetors are often forced to placate their Praetorian divisions in creative ways. The most important appointments a new Praetor ever makes are the flag officers commanding the various divisions of the Guard. He will inevitably have to trust his life to these individuals; wise choices can make the difference between a long and glorious reign and an untimely death or political defeat.

the Praetorian Fleet consists of three centuries plus the Praetor's own command wing (thus making the fleet slightly larger than a standard Command fleet).

The Praetorian Fleet often has the added distinction of being the youngest unit in the Navy, in terms of both personnel and individual service lifetimes. While loyal officers might serve in a senatorial fleet for their entire careers, members of the Praetorian Fleet are chosen on the basis of merit and loyalty. For this reason, the turnover is higher than in any other branch of the Star Navy. A fresh new crop of officers is always waiting to prove their loyalty to both Praetor and Empire.

SPECIAL FLEETS

CLASSIFIED FLEETS

Several classified fleets operate under the standard of the Star Empire. These include the secret *Tal Shiar* and *Tal Diann* (military intelligence) fleets, as well as a rumored special operations fleet under the control of the Star Command. The precise complement and disposition of these fleets remains unknown. Whatever the truth may be, their numbers, their movements, and their very existence remain closely guarded secrets. One thing is certain, though—the *Tal Shiar* never seems to want for a warbird when it needs one.

RENEGADE FLEETS

Renegade fleets form another unique facet of political life and its consequences in the Romulan Empire. Rarely, senators or coalition members who have been discredited or who have fallen into disfavor choose to flee to the fringes of the Empire, there to live out their lives in exile among the client states. When possible, such individuals normally attempt to take any remaining ships and loyal personnel with them.

Such "renegade" fleets can spend years on the run, hiding from Imperial authorities as they eke out whatever existence they can find on the fringes of Imperial space. Many turn to piracy to survive (such as the infamous Verios Fleet—named for the disgraced Senator Verios). Some take their chances beyond the Imperial borders, traveling into unknown regions of space to rimward or trailing from the Imperial core.

FLEET MARKINGS

While most outsiders are familiar with the standard "green bird" markings of the Command fleets, many other fleets mark or modify their vessels to distinguish them from one another (or to strike fear into the hearts of their adversaries). Such markings can range from simple insignia embossed on the sides of a vessel to entire variant color treatments. For example, the fleet of Senator Kassus is known throughout the Empire for its distinctive crimson vessels, while the Praetorian Fleet traditionally employs ivory and silver embellishments.

A further honorific granted to the oldest and most distinguished fleets is the Right of Standard. Similar to the Right of Adornment (used for individual uniforms), the Right of Standard is a grant bestowed upon a fleet by the Praetor and Senate. It allows the fleet to create and use a distinct insignia, device, or color scheme that remains unique to the fleet and its vessels.

THE STAR COMMAND

The Star Command serves as the administrative nexus of all Romulan Naval operations, whether strategic, military, supply, or infrastructure-related. To facilitate such a vast military bureaucracy, certain functions and offices remain centralized on Romulus. These functions include select elements of interfleet organization and assignments, the maintenance of Naval appropriations and funding, and specific supply and logistics problems. In addition, while the fleets and other line units report to both the Star Command and the High Tribunal, the other commands—Occupation, Outpost, Pacification, and Liaison—report directly to the Star Command. Their "Offices Imperium"—the special officers such as legates and censors—form an important link between the centralized Star Command and the far-flung sector and individual fleet commands.

In addition to its numerous administrative and operations offices, the Star Command also includes several specialized offices and internal administrative divisions. The Office of Appropriations handles all Naval budgets and appropri-

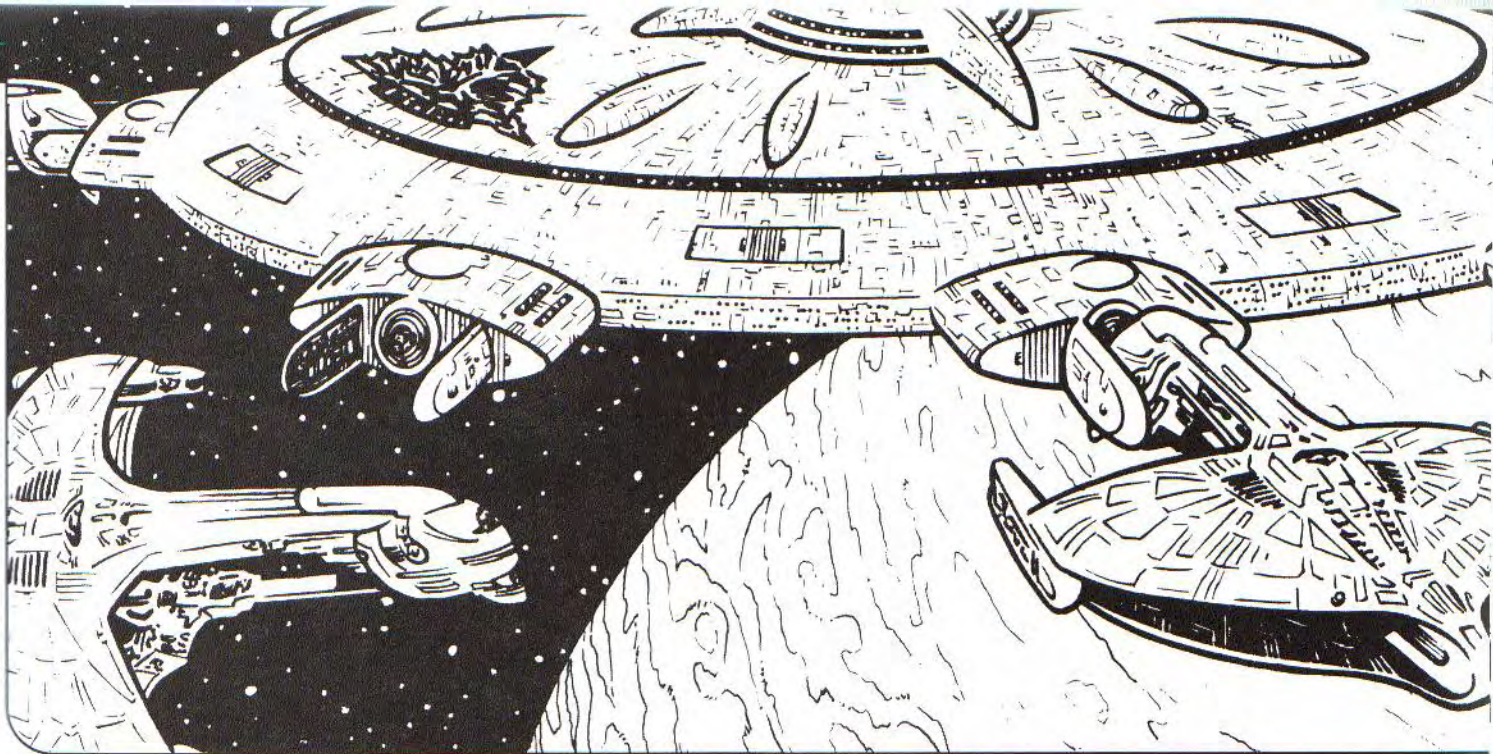

ations issues, dispersing state funding among the various fleets and standing units of the Navy. These disbursements often create tense situations among the different operational and fleet commands, as admirals vie for increased allocations.

Command fleets receive their entire operations budgets from the Star Command, while most other fleets enjoy some form of patronization or senatorial sponsorship. Powerful senators or coalitions normally flex their political muscles or call in old favors during the appropriations period, leaning on the proper committees or “suggesting” certain disbursements to their Tribunal representatives, to ensure that a favored fleet receives the desired resources.

The second ancillary Star Command office—the Office of Logistics—handles personnel and supply on a truly grand scale. Such planning includes integrated fleet resupply for large actions or engagements, materials and construction planning and approvals for both vessels and outposts, large-scale dispensation of Class VII hazardous materials and substances (including magnetic alloy housings for singularity drives, molybdenum containment chambers for heavy disruptor weapons, and similar volatile, sensitive, or restricted materials), as well as basic supply routing and integration for the various fleets and Commands of the Navy. Logistical officers can commonly be found throughout Imperial space, especially along primary routes and spacelanes. On occasion, officers of this department are stationed in outlying sectors during specified construction or materiel transfer operations.

With all its various duties, the Star Command remains a wholly political animal, albeit a well disciplined one. In its capacity as the principal organizational and administrative body for all of the fleets, it must placate favored line commanders and influential Tribunal members alike. While it maintains a reasonably firm hold on the Command fleets and the ancillary divisions of the Navy, its hold over the various senatorial and coalition fleets often depends on the current standing of the Praetor.

Its officers and admirals must walk a delicate line, constantly balancing the demands of the Senate with the needs of the Empire. After all, angry senators can be powerful enemies....

OTHER DIVISIONS OF THE STAR NAVY

In addition to the Star Command, which supervises the general-purpose command fleets, the Romulan Star Navy divides itself organizationally into a number of commands, each assuming a specialized function. Each answers to the High Tribunal (see below). Most oversee specialized fleets and units of their own. Unlike Starfleet, where horizontal movement between branches occurs on a regular basis, the divisions of the Romulan Star Navy constitute distinct career tracks of their own. Although officers often transfer among the fleets themselves, most do not transfer to other commands (or even other branches within the same command).

While these secondary divisions normally field specialized units connected directly to the Star Command itself, divisional officers are occasionally assigned to senatorial or coalition fleets for specific tours or missions. More commonly, “permanent” special units are attached to specific command fleets or territories. In rare cases, senatorial or coalition fleets in outlying regions will “cosponsor” or share a divisional outpost or office in their region. It is not uncommon for frontier Pacification or Occupation bases to be entirely within the purview of a powerful senatorial command.

THE EXPLORATION COMMAND

Because of its emphasis on exploration and research, rather than more glamorous endeavors such as occupation, assignment to the Exploration Command remains a rather unglamorous posting. While its mission—the exploration of new territories and worlds—is a necessary and important aspect of *D’era*, military tours generally carry greater prestige. The Exploration Command often assigns individual Exploration wings and centuries to specific sectors or larger regions, with small scout and survey craft spreading out through a distinct area of space.

The Exploration Command normally does not group vessels into entire fleets; rather, it assigns tours and postings according to the smaller “wing” grouping (approximately fifteen ships). Exploration wings can be found

throughout Romulan space, with vessel concentrations highest along the coreward and rimward frontiers, along the Empty Frontier and the Taurhai border. The Exploration Command currently has twenty-six wings in active service—since Exploration traditionally comes last in most budgetary debates, most of its wings are not maintained at optimal operational levels.

Exploration officers typically maintain that theirs is a purer expression of *D'era* than that of their military brethren. They often refer to their positions in Exploration as an embodiment of a true “calling,” a response to the lure of discovery and the unknown. They take the criticism of their more militant comrades in stride. After all, some of the greatest accolades in Romulan history have been given for Exploration officers who have made critical or important discoveries. While Exploration is often considered a political dead-end, most *T'virik* (“wanderers,” as they call themselves) wouldn't have it any other way.

THE PACIFICATION COMMAND

When they think of Romulan military forces, most outsiders think of the distinctive warbird decloaking to attack its victims. Little known outside Romulan space are the Empire's elite Imperial Shrikes. Serving as elite forces specially trained for insertion and pacification, these troops would have been called “Marines” on ancient Earth. These units serve almost exclusively under the auspices of the Pacification Command, and thus constitute a separate branch of the military.

The Pacification Command serves as a significantly more militant analog to the UFP's Colonization Division. The Romulans conquer worlds; they don't colonize them. The insertion forces under the Pacification Command—from the elite *Tal Shava* marines to the infamous *Ventava* Legion—conquer and occupy planets in the name of the Empire. During pacification operations, transport vessels move Shrike brigades into position for landings and orbital drops over hostile worlds, while starships provide escort and orbital cover. These forces seize key locations, then move out to suppress the countryside, while ships detailed to this command provide planetary support (in the form of orbital bombardment and perimeter defense). Pacification units are trained and equipped to do whatever it takes to pacify a world completely.

THE OCCUPATION COMMAND

Once units of the Pacification Command accomplish their mission, units from the Imperial Occupation Command move in to finish transforming a world into a respectable Imperial client state. Led by officers known as censors, Pacification units combine elements of a propaganda corps and a planetside military police force with long-term logistical support.

Censors serve as interim planetary governors until senatorial directives establish permanent settlements or grants on newly established client worlds. Even after a new grant takes effect, most censors remain in place for a time to maintain military oversight. Members of the Occupation Command often become paternal toward the worlds to which they've been assigned; censors serve the Empire as direct informational links to a world and its cultures. Censors typically assume many of the more social duties of diplomacy and cultural interaction with client states, and serve the Empire as direct conduits between a client world's culture and the Romulan Empire. In fact, other divisions, especially fleet officers serving on the line, refer to the censors as *T'shara* (“those with sympathy”).

In addition to propaganda and policing, the division arranges for any new infrastructure a colony or new client might need—new roads, starports, orbital facilities. The Imperial Corps of Engineers exists as a subdivision within the Occupation Command; its ranks consist of highly trained naval architects and structural engineers, most of whom remain in high demand due to their limited numbers. The Star Command and the various command fleets tend to monopolize the Corps, appropriating engineers to design and build new vessels. This also helps the Star Command maintain centralized control over the construction of new ships far from the Imperial core.

THE TAL DIANN

Akin to a vast internal affairs division, the *Tal Diann* maintains and monitors relations between the Star Command and the various fleets, and among the fleets themselves. Its officers—called legates—maintain a smooth operational atmosphere throughout the Navy, no easy task considering the disparate nature of the

various fleet structures. To this end, each fleet (and each wingship) has several legates permanently attached as observers.

Legates receive their power directly from the Star Command and the Praetor, and as such possess nominal jurisdiction over all orders and fleet movements. In reality, political considerations often take center stage, and the *Tal Diann* is often considered one of the most "comfortable" postings in the Star Navy. Many officers with future political aspirations choose this division for their careers.

The *Tal Diann* plays a critical role during times of crisis or war. In threat situations or protracted military campaigns, legates oversee operational and power balances between fleets not accustomed to working together. In such cases, the Star Command establishes temporary "field hierarchies" and nonstandard command chains; while commanders in the field may be loath to honor such field alterations and brevet promotions, the legates attached to their vessels or units enforce them. Officers from the *Tal Diann* monitor all activities within these temporary coalition and command fleets, reporting any unusual or suspicious events or orders to the Star Command.

In addition to policing the ranks of the military, the *Tal Diann* serves as an intelligence branch attached to the Romulan military. While the *Tal Diann* does not wield the same level of power as the more ubiquitous *Tal Shiar*, it commands a formidable respect within the military. On a more global level, the *Tal Diann* and the Military Affairs branch of the *Tal Shiar* often find themselves at odds with one another; neither organization would mourn the downfall or political destruction of the other.

THE OUTPOST COMMAND

All spaceborne stationary and planet-based operations fall under the purview of the Outpost Command. Charged with the construction, placement, patrol, and maintenance of the Empire's numerous short- and long-range bases, the Outpost Command boasts a larger permanent staff than any other division except the Fleet. Because of the stationary and often far-flung nature of Romulan bases and outposts, officers in this division normally serve out their entire tour at a single location.

The Outpost Command works closely with the Occupation and Pacification Commands, providing orbital and planetside bases to enable these divisions to complete their missions. Temporary Occupation and Pacification bases are constructed using modular templates—numerous designs exist, and each can be tailored to specific planetside circumstances or mission profiles.

The Star Navy employs several different designs of spaceborne and planetary bases, depending on an individual region and its needs (*i.e.*, near a volatile border, near a large number of client states, etc.). Most bases have at least one wing (or more) of a command fleet assigned to them. The fleet uses the base as a staging area for certain operations, and its vessels also provide security for the base itself. Romulan outposts generally fall into one of two broad categories: supplied and sustaining.

SUPPLIED BASES

Supplied bases remain the most common type of outpost in Romulan space, usually found in more heavily populated areas or along primary military supply lines.

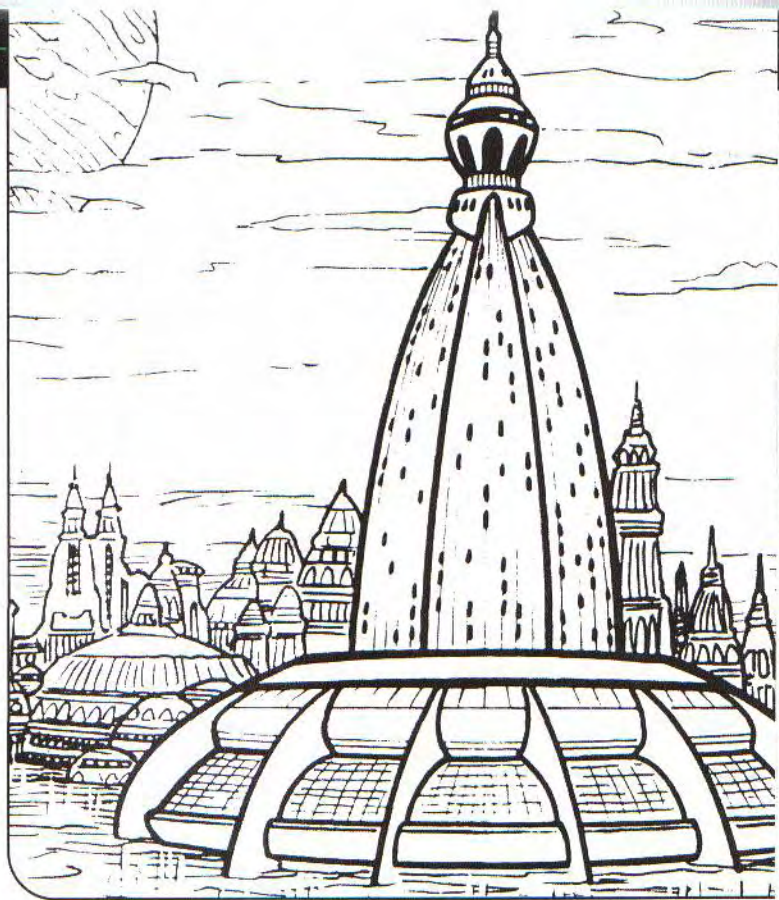

Supplied bases require regular resupply to continue normal operations, although most can operate independently for several months in times of crisis.

Star Outposts are the largest type of spaceborne base, and the most common throughout the Imperial core and in other highly sensitive regions. The Romulan military uses several different designs. Depending on the design and the base's function, an outpost could have between 6,000 and 50,000 residents and crew.

Command Bases are slightly smaller than most star outposts, with crew complements ranging from 2,000 to 15,000 officers and soldiers. While star outposts often have large civilian contingents present, command bases serve as dedicated military facilities. Most sectors contain at least one command base, which usually serves as the location of the sector command. Command bases may be planet-based.

Staging Arrays are vast, open, space-based structures, serving as staging areas for large fleet actions or missions. They support small crew complements, and most contain state-of-the-art vessel maintenance, fueling, and supply facilities. Staging arrays are normally found in war zones or other high-threat regions.

Support Outposts form the final category of supplied base. These facilities include manned listening arrays and subspace relay stations, orbital shipyards and weapons construction factories, and secret military research facilities. Such bases are found throughout Imperial space, and their crews vary widely according to an individual facility's size and function.

SUSTAINING BASES

The Romulan Star Navy typically establishes sustaining bases in outlying sectors or along Imperial frontiers, far from conventional military supply avenues. These bases are capable of long-term, or in some cases indefinite, self-sustenance. Since their function varies with their missions and locations, their crew complements also vary considerably. While many of these bases tend

to be older designs, retired to outlying sectors after years of service, others are state-of-the-art facilities, responsible for defending key border regions or hostile frontiers.

Frontier Outposts often represent linchpins in the Empire's defensive operations, and as such are analogous to large star outposts. Many of these are self-sufficient, either incorporating extensive hydroponics or zero-g agricultural facilities, or located near a Class M world (from which they receive supplies and resources). These bases are normally found along imperial frontiers or in border regions.

Deep Space Outposts are generally assigned to sparsely populated regions of Romulan space, or in distant sectors that remain largely unexplored. Older and smaller than frontier outposts, deep space bases tend to be uneventful postings, serving as way stations for Exploration and Occupation teams. Certain well equipped deep space outposts exist—these are placed adjacent to active client states or along distant long-range trade or supply routes.

THE HIGH TRIBUNAL

The organization of the Romulan military, at its highest levels, appears almost republican compared to a similar alien organization such as Starfleet or the Imperial Klingon Defense Forces. The High Tribunal controls the Romulan military, making sweeping decisions regarding military policy and budgetary expenditures. In times of crisis, it serves as the primary advisory body for unified fleet actions and operations-level planning. The High Tribunal is composed of representatives of the various commands and fleets of the military, as well as several Senate representative and the Praetor.

In the Tribunal, various senators and fleet representatives jockey for position. As in other areas of Romulan politics, alliances are forged and shift with the tides. Tribunes ally to support each other on a particular vote, such as fleet deployments and allocations, or undermine rivals. The Praetor, as the premier military leader, is considered the first among equals, and his opinion often carries the day. In this climate of give and take, what emerges is a strangely "democratic" process that usually places the needs and security of the Empire over individual ambitions. While the system it supports may seem less than perfect to many line officers, most flag officers and senators recognize both its utility and its necessity.

In certain fleets these delegates, called tribunes, are elected, while in others the most senior flag officers serve as representatives. In the Praetorian and Tullan Fleets, the most honored officers are selected, while in many of the core fleets tribunes are selected by their patron senators or coalition members. Most Tribunal representatives serve in this capacity for several years, after which the honor transfers to a new representative.

The High Tribunal occasionally sends representatives into the field as well. Called line tribunes, these officers typically come from the Navy's *Tal Diann*. Their purpose is similar to that of the legates—to observe fleet movements and operations from close proximity, and to report anything unusual to the Tribunal. Line tribunes are rarely assigned to fleets during peacetime; rather, it has become a crisis position, used during threat situations to watch specific wings or commanders whose actions have raised eyebrows or been called into question by a member of the High Tribunal. The arrival of a line tribune lets a commander know that his vessel will probably see some action soon.

Over the years, the High Tribunal has become the principal advisory arm for the Praetor as he formulates long-range planning and policy directives for ongoing and future military operations. It also provides the Praetor the opportunity to keep apprised of the circumstances and mood in the military, and allows him to keep an eye on ambitious or self-serving senators. He can move effectively to squash political coups through fleet redeployments, or, with a few words, reshape debate. Senators and admirals use the High Tribunal to gauge their standing with the Praetor; an admiral with the Praetor's favor might receive additional resources or plum assignments, or a senator out of favor could see his budget slashed.

The modern Tribunal stands as a badly needed system of controls in an otherwise politicized arena—only in the halls of the Tribunal on Romulus does the smallest senatorial unit command the same respect as the greatest consular fleet. Its very existence serves to temper the ambitions of the powerful with the ever-present ideals of *D'era*. The fleets of the Romulan Navy represent a disparate military assortment, and an even more diverse array of command philosophies. The presence of the High Tribunal serves as the ultimate balance, a body before which all units stand on equal ground.

Life in the Star Navy

Life in the Star Navy is a complex web of shifting loyalties, political maneuvering, and personal ambition. Although most officers are capable individuals, merit rarely outstrips cunning when tours are assigned or new postings are announced. In the service of the Empire, whether in the Star Navy, the Imperial Marines, or the Planetary Command, whom you know is often far more important than what you can do.

If you ignore the constant political undertones, life aboard a warbird or outpost differs little from a similar posting in the Federation's Starfleet. The Star Command generally makes an effort to place cadets in positions suited to their desires or abilities. Obviously, the most sought-after positions and postings are reserved for more experienced officers, or those with the most prominent connections. Because of the vast size of the Star Navy, however, even the average officer has a decent chance of receiving a requested tour. Most tours in the Star Navy last five years, and most officers enjoy several different postings throughout their careers.

While service and attention to duty carry value with them, only tangible results gain significant notice from the Star Command. In a military organization where political connections can cause commanders to fear their subordinates, an officer with an impressive record of successes and victories quickly gains both notice and influence. This is perhaps the most hypocritical aspect of Imperial service, military or otherwise—while *D'era* supposedly guides Romulans in every aspect of their lives, those who realize their ambitions often do so by circumventing such ideals.

POSITIONS BY BRANCH

Much like Starfleet, the Romulan Star Navy consists of three distinct service branches—Command, Tactical, and Operations. All Romulan officers choose a branch of service when they enter the Navy. The Operations and Tactical branches have the most members, while Command officers often hail from powerful or well-connected families. Position breakdowns fall along more military lines than those in an organization like Starfleet.

As in the larger divisions of the Navy, transfers among branches are rare—most officers remain in their original branches throughout their careers. The following sections provide brief descriptions of each branch, along with common shipboard positions occupied by officers within the branch.

COMMAND

Command officers in the Romulan Star Navy possess many of the same traits as their brethren in foreign fleets—most Command personnel are strong, charismatic individuals capable of leadership in a wide variety of situations. Romulan Command personnel tend to be more ambitious than their Starfleet counterparts, partly because of the political demands often placed upon their positions and partly because promotion finds only those who stand out from among their peers.

Most Romulan starship and outpost commanders come from this branch, as do many front-line officers in the ancillary commands and offices of the Navy. Command is the only branch that sees any volume of transfers into its ranks—capable officers from other

branches are sometimes moved into positions of authority, and thus into the Command branch. Most starship CO's and many XO's come from this branch, as do many legates.

TACTICAL

The Tactical branch of the Star Navy represents a uniquely Romulan division of labor. Security aboard Romulan vessels and outposts is far more sweeping and much stricter than on Starfleet vessels, and the Prime Tactical Officer on a Romulan vessel often serves as the ship's XO. Its departments include Security, Materiel, Communications, Ship Tactical, and Planetary Tactical.

The Romulans divide the functions of this branch into two aspects—security and ship tactical. Officers assigned to security undertake the duties commonly associated with Starfleet's security guards—protecting key areas of the ship, patrolling decks, detaining intruders, and serving as troops on the ground. This frees up ship tactical officers to concentrate solely on a ship's external security, such as firing the ship's weapons, monitoring sensors, and supervising power allocation to the shields and cloaking device. During crisis situations, certain Ops management functions may be taken over by the Prime Tactical Officer.

OPERATIONS

The largest branch of the Star Navy, Operations bears responsibility for all nontactical and nonsecurity aspects of starship or outpost operation. Numerous subdepartments comprise the Operations branch, including Sciences, Medical, Navigation, Engineering, Flight, Logistics, and Environmental. Operations officers perform most of a starship's primary functions, and comprise the bulk of a centurion's command staff.

The Prime Flight and Prime Navigation Officers are responsible for keeping a ship on course, while the Prime Engineer oversees the operation and maintenance of a vessel's quantum singularity drive systems. The Prime Operations Officer ensures that all of a vessel's myriad other systems—from sensors to replicators—are functioning properly. Prime Science oversees any scientific or research personnel posted to a vessel, Prime Medical monitors the ongoing health of a ship's crew and administers its sickbay, Prime Logistics disburses ship resources and handles supply, and Prime Environment monitors and maintains a vessel's various life support and comfort systems. Together, the Operations team of a Romulan starship forms the nucleus of a smooth and efficient mission platform.

SHIPBOARD ASSIGNMENTS

Most Romulan games, like their Starfleet counterparts, will focus on a vessel's command staff or bridge crew, and most Romulan starships field crews in the hundreds or even thousands. While a player may choose to play the Prime Tactical Officer of a *D'deridex*-class warbird, he shouldn't forget the hundreds of Security, Communications, and other Tactical personnel in the ranks beneath him. After all, these are the crewmen that allow him to successfully perform his duties aboard ship.

Most positions on Romulan ships represent close analogs to their Starfleet counterparts. For this reason, they won't be described again here (see pp. 38-41 in the *Star Trek: The Next Generation* core rulebook for more extensive descriptions).

COMMAND

All Romulan vessels have both a Prime Officer (CO) and a Second Officer (XO). The CO (often simply referred to as "Prime") is always the centurion in command of the vessel, and many centurions remain with the same ship for many years. In most senatorial fleets, the XO is also an officer from the Command branch—such officers are normally being groomed for a future command of their own. In most command fleets, a vessel's Prime Tactical Officer also serves as the ship's XO.

Many larger ships, especially those in senatorial or coalition fleets, also have a legate—an observer from the *Tal Diann*, normally a member of the Command branch—attached to them. Since legates are removed from the ship's normal chain of command in certain situations, their presence can cause some friction among a vessel's Command staff. Additional administrative Command positions also exist on most larger ships.

TACTICAL

The Prime Tactical Officer on a Romulan ship possesses a great deal of power. The position combines elements of the Ops, Mission Ops, and Tactical roles on a Starfleet vessel of similar size. Several Second Officers, such as Prime Security, Prime Comm, and Prime Weapons, allow the Prime to handle a diverse array of duties. On larger vessels, a unique position known as the *T'durec* (sometimes called Prime Internal) is responsible for a small subdivision of internal ship's security, almost a shipboard internal affairs division. Additional specialist, duty, administrative, and technical positions also exist in each department, much as they do on a Starfleet ship.

OPERATIONS

The Prime Operations Officer oversees the functions of the remaining departments on a Romulan vessel. Like Prime Tactical, Prime Ops supervises a staff of second officers, who in turn are in charge of specific Ops departments: Prime Mission Ops, Prime Systems, Prime Flight, Prime Engineering, Prime Sciences, etc..

Larger ships support a large array of additional Operations personnel and support staff, including spaceframe and quantum engineers, sensor, transporter, cloak, and computer technicians and specialists, departmental duty officers and maintenance personnel, shuttle pilots, and a myriad of other systems and scientific specialists.

CHAIN OF COMMAND

The chain of command in the Romulan Star Navy is often misunderstood by outsiders. While the military hierarchy is rigidly enforced, a secondary "hierarchy" exists just beneath the surface. Most officers with any ambition work diligently to develop a personal network of political connections and contacts; such unspoken associations can affect rank dynamics at every level. Just as a centurion will be loathe to discipline a subcommander who happens to be a prominent senator's son, a Tribunal admiral will pause before offending a favorite centurion in the same senator's fleet. It is a delicate and shadowy game, but one in which every ambitious officer wishes to partake.

Officers occupying positions not in the direct chain of command (such as Medical officers or Environmental systems officers) tend to rise through the ranks more slowly. They have less chance to prove themselves directly in crisis or threat situations, and as such often escape the notice of their superiors. Because of their secondary roles, it is also more difficult for them to make valuable connections. Exemplary service is often overlooked in the Star Navy—results get noticed.

FLAG OFFICERS

The highest-ranking officers in the Star Navy, Romulan flag ranks include Fleet Admirals, Wing Admirals, and Sector Admirals. Unlike Starfleet admirals, admirals in the Star Navy rarely command individual vessels or outposts; instead they serve as administrative overseers for broad operational areas or fields. Unlike Starfleet, where the distinction between a fleet admiral and a rear admiral is often slight, flag ranks in the Star Navy are rigidly enforced. Because of the nature



of Romulan glory and ambition, however, Romulan flag officers are perhaps more eager than their counterparts in other forces to see front-line action. It is not unusual for a sector admiral to command his own wingship during a routine pacification operation—after all, one never knows when *D'era* will intervene to give one an Imperial triumph.

Fleet admirals normally handle operations-level planning and fleet deployment. They also command the various regional command staffs and diverse admiralty commands—in this capacity, fleet admirals take charge of all major military divisions, from the *Tal Diann* to the Occupation offices. In times of crisis, fleet admirals occasionally take direct charge of large mobile task forces or operations groups. Such groups normally include several fleets.

The rank of Wing Admiral remains something of a misnomer in the Star Navy. Wing admirals normally command entire fleets, and their commands are usually restricted to specific sectors or groups of sectors. They can also be found commanding smaller admiralty commands (such as the various offices within the Exploration or Occupation Commands), or serving on larger operations staffs under fleet admirals.

Sector admirals can often be found commanding individual Imperial sector commands, or serving as staff adjutants on regional admiralty commands, as high-ranking legates or tribunes, or as century or wing commanders in the Navy's command fleets. Normally assigned to specific regions of space, sector admirals tend to be the "rovers" among the flag ranks, moving to areas where leadership is most needed for short periods of time. This is especially true during times of crisis or war. Most of the commanders of the Navy's innumerable ancillary departments (Medical or Colonization, for example) hold the rank of Sector Admiral.

LINE OFFICERS

The rank and file of the Romulan Star Navy's officer corps, line officers staff and command the innumerable ships and outposts that form the heart of this vast organization. Serving "on the line," they carry out the diverse missions and ongoing operations of the Navy. Rank in the Star Navy is roughly analogous to rank in Starfleet. Centurions (equivalent to Starfleet captains) command all but the smallest vessels. Originally in charge of entire fleet centuries, the role of centurion has changed over time, being largely replaced by the flag rank of Sector Admiral. In the early days of the Empire, commanders commanded individual ships. As the rank structure changed, the rank of Subcommander was created to fill the on-ship departmental gap.

Most Prime Tactical and Prime Operations officers hold the rank of Commander, while lesser department heads normally hold the rank of Subcommander (or Commander on very large ships). Regardless of the size of the vessel, department heads always hold the rank of Lieutenant, while lesser duties fall to the numerous sublieutenants and *uhlan* (the equivalent of a Starfleet ensign).

OFFICES IMPERIUM

The various "special" officers of the Star Navy occasionally hold ranks outside the normal order of advancement. All legates possess the rank of Lieutenant or higher, while those serving on the largest vessels in the fleet, such as *D'deridex*-class warbirds or *Vereleus*-class

dreadnoughts, will be commanders or even centurions. Tribunes tend to be flag officers, although some fleets send decorated centurions or even commanders to serve as their representatives to the High Tribunal.

Finally, most censors hold at least the rank of Subcommander. Their unique leadership positions—typically coordinating operations between several different branches—often require them to organize multiyear missions, necessitating a higher degree of respect from their subordinates. Remember that rank in these "special offices" often indicates respect or ability in areas other than direct command—many legates and censors have never commanded a starship, but they possess other skills of great value to both the Navy and the Empire.

CIVILIANS

Contrary to Starfleet convention, the Star Navy remains purely a military organization, and does not permit civilians to live on board their vessels. In the rare cases where civilian personnel must use a starship (a civilian scientist conducting an experiment, for example), they remain confined to those areas of the vessel necessary for their work.

Senatorial and ambassadorial retinues form the sole exception to this rule. Senators can always count on transport from a ship in their own fleet, or from a vessel belonging to the coalition to which they owe allegiance. In rare cases, they may be given use of vessels from the Praetorian or Command fleets for specific purposes or missions. Since most Romulans of senatorial rank have served in the military, such privileges are perceived as honorifics rather than transgressions of the Precept.

UNIFORMS

The Romulan Star Navy employs a wide variety of uniforms to help identify officers and enlisted personnel by branch, division, and fleet. The common officer's uniform of the early to mid-24th century is a decorative tunic with exaggerated shoulders, belted and woven in a geometric pattern. The geometric tunic patterns represent the fleet or unit in which an officer serves. Most command fleets use the traditional "checkerboard" metallic pattern, while the Praetorian Fleet utilizes a scaly, almost "chainmail" design. Fleets or divisions that have been granted an adornment employ still other patterns (see below). Black or gray pants made of stretch fabric, black boots, and a gray undertunic round out the uniform.

A wide sash that tucks into a utilitarian belt is the last item. These sashes are woven from metallic fibers, with similar color tints representing each of the Navy's branches—dark silver for Operations, silver with green for Tactical, and silver with bronze for Command. Rank is delineated by small metal insignia pins worn on the collar of the undertunic.

Prior to 2372, the Romulan uniform included a metal, decorative "harness" which came over the shoulders to join in a "Y" on the officer's chest with a clasp, and then connected to the belt. The clasps of both the belt and harness were delicately worked into the symbol of the Star Empire. The harness delineated an officer's rank and branch of service, while the number of interwoven metal bands indicated rank. A dark, burnished silver harness represented Operations, silver with slight green highlights indicated Tactical, and silver with gold/bronze highlights represented Command.



RIGHT OF ADORNMENT

A tradition dating back to the founding of the empire, the Right of Adornment serves much the same purpose as the Right of Standard—a fleet or unit honored with a Right of Adornment may design an original fabric pattern for its uniform tunics. Although most tunics employ variations on simple geometries, the shapes and colors change from one type of uniform to another. For example, the standard “checkerboard” woven pattern delineates the bulk of the Star Navy’s command fleets, while the Othan Fleets employ a colorful interweaving of squares and rectangles, and the Kassus family’s fleet uses severe bronze triangles with crimson highlights. Although considered archaic by certain progressive commanders and politicians, most officers appreciate the symbolic importance and tradition embodied by the various adornments in use throughout the Empire.

MISSIONS

In a territory as vast as the Romulan Star Empire, the various imperial military forces are called upon to perform a wide variety of missions. Most mission profiles fall into one of three broad categories: offensive, defensive, or passive. Offensive missions remain the most sought-after profiles, even in the changing threat environment of the late 24th century. Such missions often reward aggression and quick thinking, providing officers with ample opportunities to fulfill personal ambitions and follow the multifaceted aspects of *D’era*.

Defensive missions constitute an important component of Star Command operational policy. With tensions running high along several borders, the modern Star Empire exists in dangerous and challenging times. As these challenges grow and become more prevalent, the number and importance of defensive missions continues to increase. Profiles not considered offensive or defensive are classified as passive missions by the Star Command. As such, most sector commands relegate such missions to subordinate or second-place status on their operational agendas.

OFFENSIVE MISSIONS

CONQUEST

The mission every centurion waits for, missions of conquest were once more common than they are in the modern Star Empire. Normally carried out by entire fleets or wings, conquest missions can last many months. They target entire sectors or regions of space, with fleet wings moving methodically from system to system, conquering as they go. Conquest profiles often follow exploration and survey missions, but precede extensive occupation and pacification campaigns.

INVASION

Smaller or more limited versions of the more sweeping conquest missions, invasion profiles include both planetary and regional movements. Concerted and surgical invasion profiles often follow a broader conquest operation, with individual units or wings assigned to do the final “mopping up.” Invasion operations are normally coordinated with the Pacification Command, and a concerted invasion strategy usually serves as the prelude to a full-scale occupation.

AMBUSH

Small and specific missions where stealth and secrecy are paramount, ambush profiles involve a great deal of patience. Units often wait for days, weeks, or even months for a specific target to become vulnerable, or a certain vessel or shipment to pass by on a well known trade route or shipping lane. Some ambush missions involve an elaborate deception designed to lure a craft into a vulnerable position.

PROVOCATION

A uniquely Romulan profile, provocation missions often initiate protracted shadow games of “cat and mouse,” sometimes lasting for many years (the situation along the Neutral Zone serves as a prime example). Such missions commonly involve testing an enemy’s resolve. The most successful provocations place the enemy exactly where a commander wants him—within reach and vulnerable.

OPERATIONS

A standard catch-all mission category, offensive operations include everything from long-term occupation and pacification campaigns to protracted front-line fleet operations during periods of open war. While most offensive operations missions are part of larger strategic initiatives, these mission profiles can also include limited tactical response profiles as well.

DEFENSIVE MISSIONS

PATROL

Most Romulan military vessels find themselves assigned to regular patrol duties at some point during a normal posting or mission. Such missions lie at the heart of Imperial defense, especially with the currently tense climates along several of the Empire’s frontiers. Routine reconnaissance of familiar systems, observation of newer systems slated for future conquest and occupation, investigation of strange phenomena or goings-on—all of these varied missions take the form of one type of patrol or another.

THREAT ALERT

While these missions are often undertaken on the front lines of any new conflict, their genesis normally involves periods of protracted waiting. Most threat alert missions take one of two forms: a static posting at some type of outpost or base, monitoring a specific sector or region of space; or a confined patrol throughout a limited area of space, watching for specific threat actions or vessels. Current threat alert regions include the Neutral Zone, the Taurhai border sectors, and portions of the Empty Frontier that currently serve as havens for raiders and renegades.

RESPONSE/TACTICAL

Similar in some ways to straightforward threat alert profiles, tactical and rapid-response missions are the most aggressive defensive profiles recognized by the Star Command. Essentially offensive responses to a hostile action or threat, vessels or fleets in the immediate region normally handle these missions. Romulan



perimeter defense units and rapid response wings boast extremely quick response times. The fleets and units stationed on the Imperial perimeter must be prepared to react to developing threats at a moment's notice.

CONVOY/ESCORT

Normally the most uneventful defensive profile, convoy and escort duties nonetheless remain crucial elements of long-term operational security and effectiveness. Romulan vessels travel in convoy only during times of crisis or war, or when traveling through hostile or dangerous regions of space (a volatile client sector, or a region plagued by shipping raiders).

PASSIVE MISSIONS

DIPLOMACY

While most delicate diplomatic missions are undertaken by senatorial or Praetorian representatives, diplomatic missions usually involve negotiation or arbitration with the leaders of a client world or ally. Officers under the Exploration Command handle first-contact missions, while Occupation Command officers handle most cultural relations and "attaché" duties; in some cases resident censors receive permission to negotiate on the Empire's behalf. These missions typically involve an aspect of "showing the flag," with the ship demonstrating the Empire's concern as well as its might.

EXPLORATION

The province of the Navy's Exploration Command, deep space exploration and discovery are essential

facets of the expansionist spirit embodied in *D'era*. Continued exploration allows the Empire to locate new worlds to occupy and new species to pacify—all in the name of the Praetor and for the glory of the Empire. Much like the Federation, the sheer volume of Romulan space is staggering, taking centuries to explore fully. Officers and personnel from the Exploration Command remain at the vanguard of Imperial exploratory operations and initiatives.

PRECEPT AND CANON

The Romulan Star Navy is a clean and efficient organization, one with a proud heritage and numerous time-honored traditions. Although its vast size suggests otherwise, the body of rules and regulations governing the actions and conduct of officers remains very small (especially when compared to similar collections of law in other societies—the UFP's Uniform Code of Justice,

THE PRECEPTS

The Precept of Loyalty: According to this precept, Romulan soldiers owe their highest loyalty to both the Empire and the Praetor. Disloyalty weakens the Empire. A Romulan officer is expected to place personal considerations second to the needs of the Empire. Romulan soldiers are expected to bear any number of discomforts in the pursuit of *D'era*.

The Precept of Discipline: In order to promote and preserve the Empire, every Romulan soldier must obey his or her commanding officer. Romulans assume their superior officers possess knowledge and directives they are not privy to. Questioning orders is seen as a serious breach not only of discipline, but loyalty.

The Precept of Strength: For the Empire to remain strong, according to this precept, it must continue to expand. In this way, the Romulans see themselves as following the lessons of the Vhorani. Weaker species outside the Romulan sphere of influence could one day become a threat. Species equal in might to the Empire already pose a threat. Only by absorbing both can peace come to the Empire.

The Precept of Denial: This precept exhorts Romulan soldiers to take their own life in the event of capture, to deny the enemy victory. Romulan commanding officers must destroy their vessels in the event of failure, to deny the enemy prisoners and trophies. To do otherwise would give the enemy valuable information, and compromise the security of the Empire. This is often the last duty a defeated Romulan carries out in the name of the Praetor.

The Precept of Watchfulness: All Romulans, particularly in the military, remain alert for any danger to the Empire or its ideals. Perhaps originally the companion to the Precept of Loyalty, this exhorts Romulans to report any signs of disloyalty. In practice, Romulans cite this precept when searching for enemy agents. In addition, this precept warns Romulans to safeguard against alien ideas that could compromise their loyalty.

for example). If a Romulan officer or soldier abides by the precepts, he will enjoy a long and productive career.

There are two primary collections of military regulations in the Star Empire—the Precept and the Rules of Legation (also called the Canon). By far the most important, the various individual orders of the Precept establish the guidelines by which a Romulan officer must perform his duties and live his life in the military. Virtually unchanged since the time of Tellus, the Precept represents the only true law in the Star Navy. It embodies the concepts of obligation and service so central to *D'era*; transgressions are taken very seriously indeed.

Violation of the Precept's rules brings swift and simple punishment. Unlike the often convoluted legal systems of its adversaries, only two penalties accompany transgressions against the letter of the Precept—censure and death. Justice is swift and sure, and in many fleets officers regard a full censure as a fate equal to death. Censure commonly involves demotion to a lower rank, and is given only for less severe violations. In some severe cases, violating the Precept means one thing—death.

The second collection of military “laws”—the Rules of Legation—remain in limited use in the modern Star Navy. While most of the important Rules of Legation (in the earliest period of Imperial history, these were the Rules of Legation and Vendetta; the Vendetta rules were dropped centuries ago) have become newer aspects of the Precept, a few important Rules remain. Since they dictate the powers given to legates aboard vessels or outposts, these Rules become important during times of crisis. The *Tal Diann* jealously enforces the importance and weight of these rules; after all, their existence and power depend on them.

Finally, the Praetor or High Tribunal occasionally issue special fleetwide regulations during times of crisis or danger to the Empire. These Praetorian or Tribunal Edicts carry the same legal weight as any order of the Precept, and officers are expected to follow them without question. Overall, regulations and directives tend to be deemphasized within the ranks of the Romulan military—there are few gray areas, and every officer understands that service demands absolute obedience. It is the *Way of D'era*.

THE DEFENDERS OF D'ERA



The name "*Tal Shiar*" is derived from an ancient Vulcan root translating roughly as "swift death" or "merciful execution," and the name is well earned. The *Tal Shiar* is the feared and secretive Romulan Intelligence Service, the group which exists to ensure the loyalty of all citizens of the Empire, and to protect the Empire from all threats, both internal and external. The *Tal Shiar* has broad, sweeping powers, and its influence extends to all areas of life within the Romulan Empire. Every citizen can rest easy knowing *Tal Shiar* agents are everywhere, carefully watching for any sign of disloyalty or any potential threat to the security of the Empire.

The *Tal Shiar* is considered above the law in many ways. They ensure the loyalty of all Romulans, including government officials and military personnel. In order to do this, the *Tal Shiar* does not answer to any authority save the Praetor and the Senate itself, and even the Senate has limited power over the *Tal Shiar*. The organization sets its own budget, and chooses and trains its own personnel. Much of what the *Tal Shiar* does happens completely out of sight, unknown to anyone except the highest and most trusted officials in the Romulan government. This secrecy allows the *Tal Shiar* considerable freedom to carry out its mission.

The *Tal Shiar* expects, and receives, the cooperation of Romulan citizens in carrying out its directives. All Romulans are expected to be ever vigilant for signs of disloyalty or treason, and to report them to the *Tal Shiar* so it can take action. No citizen knows if his neighbor or friend might be a spy for the *Tal Shiar*, so few, if any Romulans willingly voice disloyal or dissenting opinions in public (or even in private with friends and family). This policy allows the *Tal Shiar* to monitor a population as vast as that of the Romulan Empire. Very little escapes its notice for long. False accusations occur from time to time, but the *Tal Shiar* takes such matters seriously. Those who commit perjury or offer false testimony to the *Tal Shiar* are exposed and severely punished for trying to turn the Empire's guardians against loyal citizens.

Agents of the *Tal Shiar* also receive the complete cooperation of the government and the military in carrying out their vital work. An agent of the *Tal Shiar* can commandeer whatever resources he needs to carry out a mission, up to and including Romulan military resources like warbirds and military personnel. Agents' orders are not to be questioned, and such questions can be taken as signs of disloyalty in and of themselves.

In return, agents of the *Tal Shiar* are expected not to abuse their power. They hold a great responsibility to the Empire and its people and are sworn to use their powers only in the pursuit of their mission. *Tal Shiar* agents who abuse this right represent a serious threat to the security and safety of the Empire and are dealt with accordingly. The *Tal Shiar* has a reputation for handling its own affairs, away from the eyes of the public. In order to fulfill its purpose, the *Tal Shiar* must maintain an aura of infallibility, which it does.

Organization

The *Tal Shiar* is led by a chairman, appointed directly by the Praetor and confirmed by the Romulan Senate. The chairman has complete discretionary powers over the *Tal Shiar*, but answers to the Praetor and the Senate. The Senate may remove the chairman of the *Tal Shiar*, should sufficient evidence of abuse of power exist. It requires a unanimous vote of the Senate to remove a current chairman, something that has never happened in the entire history of the *Tal Shiar*.



The position of chairman is a highly political one, so chairmen are most commonly governmental or military officers, chosen for their knowledge of the Empire and its laws. Many chairmen are former *Tal Shiar* agents with considerable field experience and knowledge of *Tal Shiar* operations. The current chairman is an aging Romulan male named Koval. He supervises the *Tal Shiar* with ruthless efficiency, taking a personal interest in all major investigations. Despite this activism, the current chairman prefers to maintain a low public profile to avoid attracting attention, controlling the *Tal Shiar* from the shadows.

Once appointed, most chairmen work to hold on to the job by performing invaluable services for influential politicians, or by gathering embarrassing information for use as blackmail, or both. When the chairman of the *Tal Shiar* is weak, the Romulan government (particularly the Senate) retains a great deal of control over the organization. A strong, influential chairman can often circumvent governmental authority and institute programs on his own authority. The most skilled chairmen manage to hide their own power, appearing as humble servants of the Empire while wielding vast influence behind the scenes.

Like the Romulan military, the *Tal Shiar* is arranged in a strict hierarchy. Unlike the military, the *Tal Shiar* tends to be secretive about its operations, and sometimes violates its own chain of command for the sake of convenience or necessity. For example, the chairman may assign certain projects or operations to agents directly, bypassing the division head and the agent's other superior officers. Such situations rarely occur, but they do happen. This gives the chairman considerable personal control over the *Tal Shiar* and allows the organization to respond to the needs of the Empire quickly and efficiently.

The *Tal Shiar* is broken up into divisions that each perform a different function. There is some competition

between divisions, but agents also transfer between divisions frequently in order to discourage such competition and encourage them to look at the *Tal Shiar* as a whole, working together toward the same goal of protecting the Empire. The security clearance of an individual agent determines how much he knows about the *Tal Shiar's* operations. Some operations are fairly well known within the organization, while others are so secret that they are known only to the chairman and the agents directly involved.

INTERNAL SECURITY DIVISION

Most Romulans come into contact with the Internal Security Division. It monitors the population, ferreting out signs of disloyalty and arresting those who are or may become threats to the security and peace of the Empire. Internal Security agents have broad discretionary powers when it comes to defining what constitutes disloyalty, as well as what is considered a "threat to the Empire." Occasionally, they overlook offenses that might otherwise result in the offender disappearing into the night, in order to round up any co-conspirators a traitor might have. The practice also makes it difficult for disloyal citizens to be certain when and where the *Tal Shiar* will act, since experience has proven that agents are everywhere. This atmosphere of paranoia makes all citizens alert for any signs of disloyalty.

Although they have many agents in place to monitor for signs of disloyalty among the population, the citizens of the Empire are Internal Security's greatest resource. Loyal Romulans report any signs of treason or disloyalty among their neighbors, friends, and associates, allowing Internal Security to take action to correct the situation. Offenders are typically sent to *Tal Shiar* controlled reeducation centers for conditioning to remove their disloyal tendencies, allowing them to return to Romulan society as productive and loyal citizens. Some more radical elements simply disappear and are never seen again. Anyone who questions the *Tal Shiar's* decision is likely to be labeled a collaborator or an accomplice and arrested as well.

Some Romulans think Internal Security has too much power and find their tactics unnecessarily brutal; they possess broad discretionary powers and prosecute loyal citizens of the Empire who simply speak their mind, or conduct political witch hunts. They can arrest individuals at their discretion and detain them indefinitely. They employ ruthless methods of interrogation, from simple torture to sophisticated holographic deception. In the early days of the *Tal Shiar*, such brutality may have been necessary: The Empire was young, with many new planets to absorb. New subjects had to be taught to respect the Empire, and potential uprisings suppressed.

Today, the organization maintains that its methods are simply efficient, and refuses to renounce them. Of course, critics do not voice their opinions in public out of fear of *Tal Shiar* retribution. Those who question the guardians of the Romulan Star Empire are labeled as traitors and vanish into the night.

MILITARY AFFAIRS DIVISION

The Military Affairs Division of the *Tal Shiar* serves much the same function for the Romulan military as the Internal Security Division does for the general population. The division is charged with ensuring the loyalty and security of Romulan military personnel, from the lowliest *uhlan* to the highest-ranking admiral. The eyes



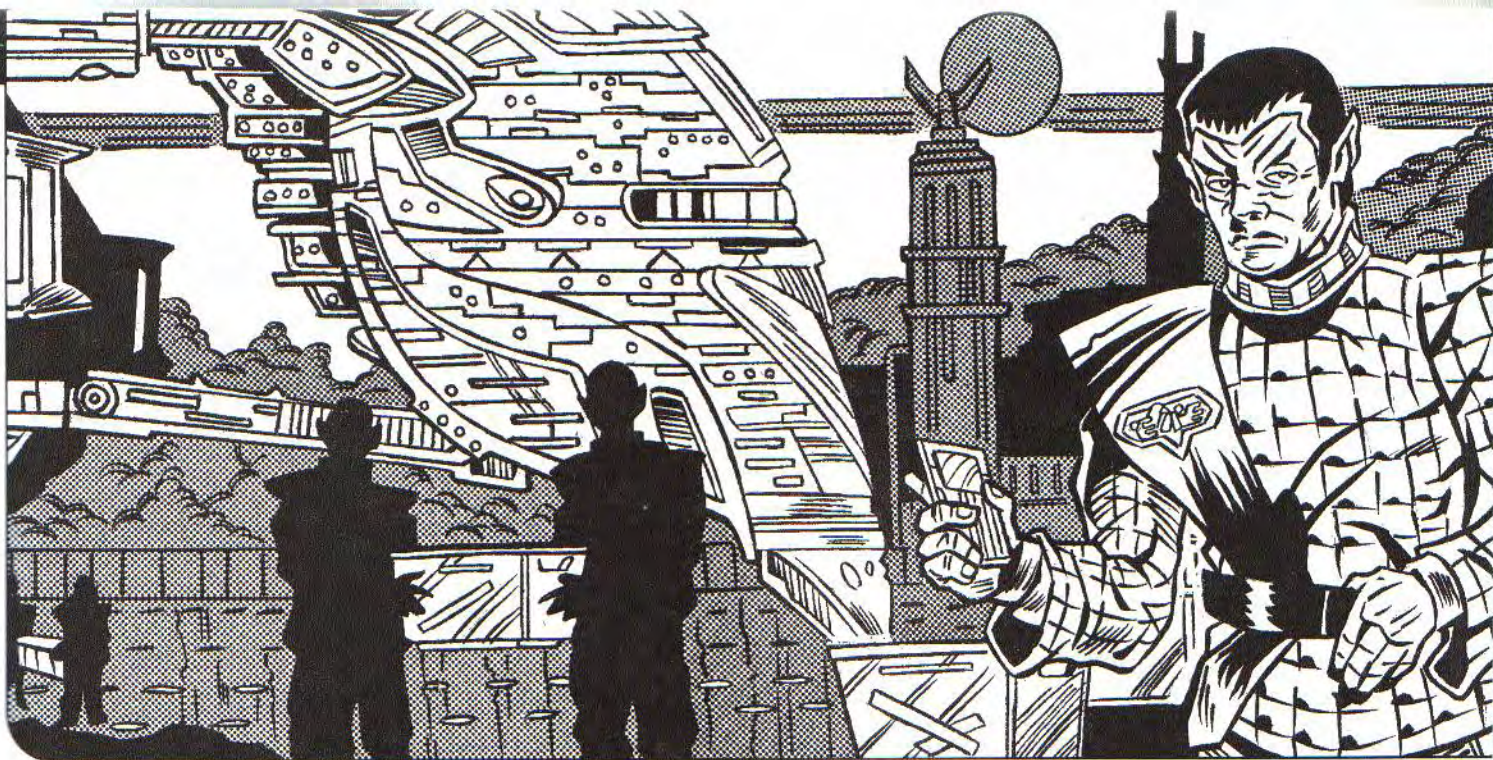

of Military Affairs are everywhere within the armed forces, constantly keeping tabs on the activities of military personnel.

In fact, Military Affairs has agents among the rank and file of the Romulan military, specially trained to maintain their cover identities while reporting everything they see and hear to their *Tal Shiar* superiors. Even more than in civilian life, members of the Romulan military become accustomed to having their every move watched by agents of the *Tal Shiar*. Military personnel often fear the power of the *Tal Shiar* more than civilians do, since a single word from a *Tal Shiar* agent can end a promising military career.

The Military Affairs Division also acts as a liaison between the *Tal Shiar* and the military forces of the Empire. They most frequently commandeer military resources for *Tal Shiar* operations, ordering ships and troops to far-flung sectors of the Empire, or even into the depths of the Neutral Zone, with no explanation other than the authority of the *Tal Shiar* to issue such orders. Although the division presents an outward appearance of working hand in hand with the military, more often they treat military forces as pawns to be used at the *Tal Shiar's* whim.

There is a strong, unspoken feeling of resentment toward the *Tal Shiar* in the Romulan military, particularly in the Star Navy and *Tal Diann*. The very existence of the Military Affairs Division implies that the military forces of the Empire are less than completely loyal, an insult to the oath of every military officer. Officers dislike the *Tal Shiar* because they sneak and spy and report on the activities of their own people while the soldiers of the Romulan Empire fight and die on the front lines for the greater glory of the Empire. Still, wise officers never voice their opinions of the *Tal Shiar* in public, since the organization has been known to ruin careers for less.

SPECIAL OPERATIONS DIVISION

Officially, the Special Operations Division handles emergency situations and serious threats to Romulan security. Unofficially, the division controls all *Tal Shiar* operations outside the Romulan Empire, particularly

operations directed against other interstellar powers. This is the most secretive branch of the *Tal Shiar* because many of its operations are technically illegal and in violation of several treaties signed by the Empire.

The primary task of Special Operations is gathering intelligence on civilizations and species outside the Romulan Empire. The *Tal Shiar* employs numerous agents for this purpose, and it has placed spies on many other worlds to gather information. Generally, these spies are surgically altered to appear as non-Romulans, although some Romulan agents attempt to pose as Vulcans on Federation worlds and regions near the Federation. Such impersonation requires considerable training and skill to suppress the natural Romulan tendencies in favor of a cold, logical Vulcan façade. *Tal Shiar* agents sometimes use the information they have gathered to blackmail key individuals on other worlds, allowing them greater access to information or possibly compromising that world's security.

The information provided by *Tal Shiar* spies is used to plan the Empire's military and strategic operations. It is Romulan nature to seek ways to test an opponent's capabilities and resolve before engaging in open conflict. The Special Operations Division seeks to test other civilizations and determine their readiness to fight against the Romulan Empire. The division also works to weaken those civilizations that are or may become threats to the Empire, particularly the Federation/Klingon Alliance. It does so through clandestine means, usually using undercover agents or brainwashing techniques to create "sleeper" agents to carry out its bidding. Romulan techniques of sabotage usually involve extensive use of misdirection, attempting to sow paranoia and mistrust among the enemies of the Empire.

INTELLIGENCE ANALYSIS DIVISION

The job of the Intelligence Analysis Division is to study all the data gathered by other divisions of the organization and sift the most useful information and conclusions from it. The division is particularly expert in activities like codebreaking and decryption using highly advanced computer algorithms.

The Romulans

Encryption experts from Intelligence Analysis Division also provide and maintain the extensive encryption locks and security systems of the Romulan Information Network, the system of computers and communications relays that links the worlds of the Empire and provides information access to its citizens. Although the progressive encryption sequences are extremely difficult to break, the Network has suffered security breaches in the past.

The Intelligence Analysis Division presents regular reports to the chairman of the *Tal Shiar* and to the Romulan Senate, keeping them apprised of information gathered by the *Tal Shiar* on matters both foreign and domestic. The reports of the division are considered some of the most accurate and reliable information available to the Romulan government, although many believe a great deal of information never reaches anyone past the chairman's office, censored by the *Tal Shiar* for reasons of security and public safety.

Among its other duties, the Intelligence Analysis Division works hard at compiling information on the Borg Collective and the Taurhai Unity, gathered during the Romulans' limited contact with the Borg and their recent conflict with the Taurhai. The *Tal Shiar* considers these interstellar powers to be serious threats to the security of the Empire, and they draw a great deal of the division's resources and personnel.

RESEARCH AND DEVELOPMENT DIVISION

The *Tal Shiar* works constantly to create new technologies to assist it in its work. This area is the responsibility of the Research and Development Division, which designs and tests new devices intended for use by *Tal Shiar* agents. Research and Development also analyzes scientific data gathered by *Tal Shiar* agents, along with technologies from other civilizations, seeking applications useful to the *Tal Shiar* and the Romulan Empire.

Rumor has it the Research and Development Division is far more concerned with producing results than they are with observing proper safety precautions and testing procedures. For this reason, and the fact that most of their work is highly classified, R&D facilities are often located on distant space stations or planetary laboratories, their locations a state secret known only to the *Tal Shiar* and certain members of the Romulan Star Navy (generally the crews of supply ships, who are not told the nature or purpose of the facilities they visit). Among the technologies worked on by the R&D Division are weapons systems, defensive systems, cloaking systems, and various types of espionage technology.

The division works on the design and creation of more powerful disruptor weapons, particularly disruptors that can be miniaturized or disguised as harmless-looking tools or other items, shielded from detection by conventional sensors. R&D also studies the applications of offshoot disruptor technologies, like the deadly and torturous Veron-T type disruptor, which slowly tears a target apart from the inside out, molecule by molecule. In the past, R&D has produced near-perfect replications of Federation, Klingon, and Cardassian weaponry for use on covert missions or for sale to certain parties, leading others to believe those powers sold weapons illegally. The only flaw in these copies is that they must be charged from Romulan power sources, so they carry a unique Romulan energy signature, detectable on close examination.

In addition to constantly developing new ways of improving Romulan cloaking device technology, the R&D Division also works on developing a practical planetary-based cloaking system for concealing entire planets. Recent innovations include cloaking devices for bases and other facilities, as well as a personal cloaking optical/holographic camouflage suit capable of hiding an individual humanoid from visual and sensor scans. The primary difficulties involved the visible distortion effects created by cloaking devices within a planetary atmosphere, along with the tremendous energy demands of a cloaking device, even a small-scale one like a personal cloaking device. These problems appear to be largely solved, although these devices remain experimental prototypes, not for general use.

Research & Development produces dozens of other devices for use by agents of the *Tal Shiar*, including miniaturized and concealed sensor and computer systems, surveillance devices, explosives, concealed personal body armor, incapacitating drugs and other chemicals, and many other items.

MIND WAR DIVISION

The Mind War Division of the *Tal Shiar* is devoted to developing and refining new technologies and techniques for interrogation, brainwashing, intelligence gathering, and psionic warfare. Like the Research and Development Division, it

tends to cross the lines between the other branches, affecting all segments of the *Tal Shiar* with its discoveries and methods. Originally, Mind War was a subdivision of R&D, but it grew rapidly and was eventually made a separate division of its own. Mind War and R&D still cooperate closely on the development of new technologies.

INTERROGATION AND BRAINWASHING

Mind War's primary work is in the area of interrogation, brainwashing, and other techniques involving the study of the humanoid mind and psyche. Mind War scientists closely study the construction of the brain, both Romulan brains and those of other species. They research psychology and sociology better to understand how the mind works and how to manipulate it. *Tal Shiar* agents from the Mind War Division are masters of subtle and brute-force interrogation techniques, allowing them to wring whatever information they want from their subjects.

For the most part, the *Tal Shiar* prefers more subtle forms of interrogation than outright torture, usually involving psychological manipulation. One cutting-edge technique involves the creation of complex psychodramas using holographic technology to place the subject into a realistic scenario where he is coerced into revealing the desired information voluntarily, usually to someone who appears to be a friend or trusted authority figure. Drugs are sometimes used to heighten the subject's experience and make the simulation seem more real.

Of course, these simulations are only as realistic as the available data can make them, so it can be difficult to simulate effectively things and people very familiar to the subject without arousing suspicion. Holographic scenarios are also highly effective brainwashing techniques, conditioning a subject to respond to a certain set of stimuli, often with the assistance of drugs and other forms of brainwashing.

Another interrogation and brainwashing technique involves the use of direct neural stimulation, transmitting the types of scenarios used in holographic simulations directly into the subject's brain. This technique has the advantage of working more quickly; since the information is fed directly into the brain, the subject can do little to block it out. Unfortunately, such treatments require the implantation of neural taps to provide direct access to the subject's brain. The evidence of such implants cannot be completely hidden, leaving some clues as to the programming or interrogation of the subject. Work progresses on the development of a direct neural stimulator that does not require the implants, using neural induction through the subject's skin surface instead. Early tests appear promising, although the technology remains in the experimental stage.

Of course, if more sophisticated methods fail, *Tal Shiar* agents are also masters of older, physical techniques of interrogation and torture. They study the effects of pain on the humanoid body and develop an amazing knowledge of anatomy and physiology, knowing exactly how to generate the maximum amount of pain while leaving the subject alive and leaving as little evidence of their work as possible. Neural implants can permit interrogators to inflict an intense amount of pain on a subject while leaving him alive. Some *Tal Shiar* interrogation techniques date back to the ancient history of Vulcan, involving primitive instruments and brutal physical treatment.

PROPAGANDA

All branches of the *Tal Shiar*, as well as the Romulan government, use Mind War's study of psychology in maintaining control over the citizens of the Romulan Empire, ensuring their loyalty by creating the ideal atmosphere of obedience, fear, and psychological need. This division controls the creation of new propaganda intended to inspire the Romulan people and strike fear into the hearts of the Empire's enemies.

Events and information are engineered to provide whatever message the *Tal Shiar* and the Romulan government wish. Romulans generally have a very different view of events involving their Empire as compared to Federation or Klingon citizens involved in those events. Of course, the Empire points to other versions of events as propaganda coming from other governments.

PSIONIC WARFARE

The Mind War Division devotes a portion of its resources to the study and development of Romulan psionic abilities and techniques. Unlike their Vulcan cousins, the Romulans' innate psionic abilities are vestigial, only barely developed. Some Mind War researchers speculate that the Vulcans, with their philosophy of complete logic and mental discipline, greatly refined their telepathic abilities over the years, while the Romulans retained their emotional natures and ignored the development of their telepathic faculties.

The ancient Vulcans possessed telepathic abilities and used them in violent ways, including brutal mind-meld interrogation and brainwashing techniques, and the use of psionic amplifying technology to create telepathic weapons. The rise of logic and the philosophies of Surak, however, rendered these telepathic warfare techniques all but useless. The inner peace and mental discipline developed by logic and control over emotion made Surak's followers immune to telepathic attack, so the violent Vulcan factions abandoned their telepathic abilities.

Now, the agents of the Mind War Division work to reclaim this aspect of Romulan heritage. All Romulans with psionic abilities are expected to use them in the cause of the Empire, and Romulans with telepathic talents are quickly recruited into the *Tal Shiar*. Mind War studies and trains these recruits in the use of their abilities. It also studies the psionic abilities of other species in the Romulan Empire, like the Tarquin (see page 88).

Telepathic *Tal Shiar* agents are among the most feared, because of their ability to invade the minds of others and glean information from them. Most *Tal Shiar* telepaths are limited to fairly close range, having to touch a subject to initiate a mind-meld, but their telepathic skills are often formidable, and nonpsionics usually have little or no defense against them.

The Psionic Warfare subdivision also researches the possibility of developing psionic-based weapons similar to those from ancient Vulcan history. The technology was lost when the Romulans left Vulcan and traveled to Romulus millennia ago, but there is some evidence from ancient Romulan ruins on worlds like Dessica II. *Tal Shiar* scientists hope to recover and reconstruct such technology and perhaps even improve upon it.

Lastly, the Mind War Division studies potential defenses to protect the Romulan Empire from foreign psionics, particularly telepathic espionage. The fairly large number of telepathic species in the United Federation of Planets, including the Vulcans and the

Betzoids concerns the *Tal Shiar*. Although Federation policies forbid the use of telepathy in espionage, the *Tal Shiar* does not trust the Federation's good intentions in the matter, and continues to study various options for providing mind shields and psionic protection to important figures in the Romulan government and military.

Operations

The *Tal Shiar* carries out dozens of operations every day, protecting the Romulan Empire from all threats internal and external, gathering information and developing new technologies and techniques for the protection of its citizens.

Internal Security spends most of its time monitoring the population of the Empire, looking for suspicious or disloyal behavior. Those individuals judged a threat to the security of the Empire are arrested and re-educated or summarily executed by the *Tal Shiar*. Internal Security's latest operations are concerned with the growth of the Romulan underground movement. The division has devoted additional resources to investigating the movement, infiltrating underground cells and ferreting out the identities of key members. It also keeps regular tabs on Ambassador Spock's activities, although the Vulcan ambassador seems quite adept at evading their observation when he so desires.

The Special Operations Division conducts various operations aimed at destabilizing enemy governments and gathering information on them for the Empire. One of the most successful of these is the placement of Romulan spies on other worlds, usually posing as Vulcans. One such "sleeper" agent, Subcommander Selok, assumed the identity of Federation Ambassador T'Pel from Vulcan and gained access to considerable Federation information (although not all of the top-secret technical specifications the *Tal Shiar* desired). Selok was returned to the Empire in 2367 as part of a supposed peace initiative with the Federation. Although a "transporter accident" was staged to make the

Federation believe T'Pel was killed, Starfleet uncovered the deception, although not in time to prevent Selok from returning to Romulan space.

Another achievement of the Special Operations Division was the defection of Ensign Stefan DeSeve, a Starfleet officer, to Romulus in 2349. Although DeSeve provided the *Tal Shiar* with only limited information on Starfleet and Federation operations, his defection, and his willingness to renounce Federation citizenship in favor of life on Romulus, was a propaganda coup for the Empire. Unfortunately, Ensign DeSeve chose to surrender himself to Federation authorities in 2369 in order to assist in the defection of Vice-Proconsul M'ret (see page 29). The *Tal Shiar* has not ruled out the possibility of DeSeve working as a sleeper agent for the Federation for the entire twenty years he spent on Romulus.

Both Internal Security and Special Operations cooperated in exposing the treason of Admiral Alidar Jarok in 2366. Jarok was an agitator who called for a restriction of Romulan expansion in contradiction of *D'era*. He was censured and assigned to command a distant outpost. The *Tal Shiar* arranged for Jarok to have access to falsified documents indicating the construction of the Romulan military base on Nelvanna III in the Neutral Zone, within striking distance of several Federation sectors. As expected, Admiral Jarok defected from the Empire and fled to the Federation, where he convinced the captain of the Federation ship *Enterprise* to violate the Neutral Zone to investigate Jarok's claims. A trap was laid for the *Enterprise* at Nelvanna III, but it was thwarted by the intervention of cloaked Klingon vessels accompanying the *Enterprise*, outnumbering the Romulan warbirds assigned to capture the Federation ship. Jarok died in disgrace as a traitor to the Empire.

TAL SHIAR SECURITY CODES

An organization such as the *Tal Shiar* employs layer upon layer of security clearance codes to shield information. Typically, this obsession for secrecy expands far beyond the reach normally associated with an espionage operation, extending into all areas of politics and society. The *Tal Shiar* classifies practically all information in the Romulan Empire with some form of clearance level. Access to all but the most basic information requires proper clearance (as well as a cipher key).

Romulan security clearances depend less on hierarchy and more on a "need to know" basis, thus creating a seemingly chaotic information network. A single report might be classified as "secret," yet contain passages classified "top secret." Thus, those with the proper security clearance only see what they need to see, and are not burdened with unnecessary information.

JOVAL (OPEN ACCESS)

Information with this level of security is freely available to anyone who can use a computer terminal. Even though a wide range of information carries this security classification, even *Joval* data is heavily laced with propaganda designed to comfort and inspire the citizenry (and misinform outside observers). Because clever intelligence agents or data analysts can piece together random bits of information to learn sensitive information—such as news reports to learn of Romulan fleet movements, for example—the *Tal Shiar* strives to "sanitize" all public information as much as possible. Examples of *Joval* classed information include most economic and scientific data, routine government reports, and recordings of most Senate proceedings.

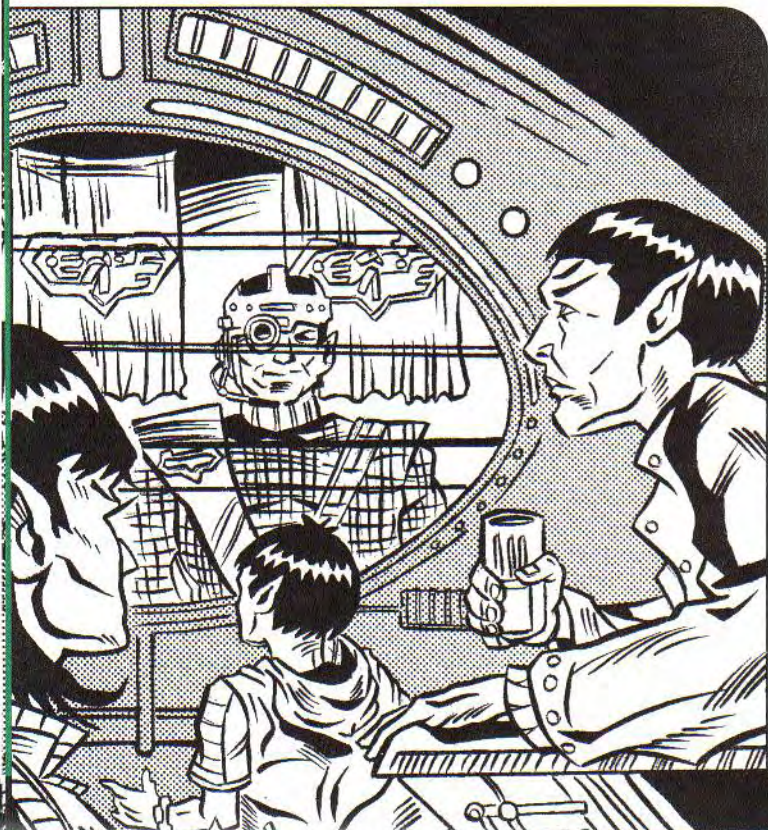

PAVAL (LIMITED ACCESS)

Particularly paranoid about the flow of information, the *Tal Shiar* targets data for particular groups or individuals. This standard classification signifies information relevant to a particular group in society. For example, without special authorization, information on tectonic activity on Romulus could only be accessed by planetologists and geologists. Each file classified as *Paval* is also coded for the group(s) granted access.

RUTA (SECRET)

Data classified as *Ruta* is not meant for general consumption, typically including information that could cause harm to the Empire. Examples include most information relating to fleet strengths and movements, real economic data, precise weapons characteristics, and the like.

VAY'RUTA (TOP SECRET)

Information with this classification would cause significant harm or embarrassment to the Empire if released to unauthorized persons. Examples include key scientific data on military research and development projects (such as propulsion, weapons systems, and the like), the Empire's overall strategic plans for invading the Federation, and so forth.

GAL'RUTA (ULTRA SECRET)

Ultra Secret information could cause extreme harm to the Empire if revealed to unauthorized persons. It represents perhaps the most secret information in the Romulan Empire. Examples include the identities of *Tal Shiar* agents in Federation and Klingon space, advanced theoretical weapons designs, and various unfiltered government reports.

ADDITIONAL SECURITY CLASSIFICATIONS

In addition to these primary classifications, the *Tal Shiar* assigns several secondary classifications further to restrict, limit, or guide the dissemination of information. A report might be classified Top Secret, Senate only, restricting access not only to senators, but to only those senators with Top Secret security clearance. A single data file could possess multiple classifications and designations.

ALITOK (SENATE)

Information with this classification, which is usually *Ruta* or *Vay'Ruta*, is authorized for release to senators. Disseminating this information in any way, even to his closest staff members, could lead to serious charges against a senator. Examples include sensitive documents on the progress of various military operations, economic production figures, and sensitive government reports.

KAL'KA'TAR (MILITARY)

Typically accompanied by the *Ruta* or *Vay'Ruta* designation, this data concerns sensitive military operations throughout the Alpha and Beta Quadrants. Access to command functions on all Romulan vessels, for example, is classified *Vay'Ruta*. Other examples include

progress reports from the field, requisitions for manpower and materiel, and strategic operations and tactical policies.

TRU (TAL SHIAR)

A Romulan play on words, using the word for "peace" as the classification for materials restricted by the *Tal Shiar*. Similar to the *Alitok* and *Kal'ka'tar* designations, material with this classification is intended only for the eyes of *Tal Shiar* operatives with the proper cipher key. Typically *Vay'Ruta* or *Gal'Ruta*, this data pertains to *Tal Shiar* operations and intelligence.

SHAYA

The chairman of the *Tal Shiar* encrypts data and classifies operations under this category, making it perhaps the most sensitive security clearance after *Ra'tar*. Information or operations deemed *Shaya* remain unknown to all but those given access by the chairman. The most advanced fractal encryption routines available to the *Tal Shiar* protect this information. Examples include personal files on key individuals throughout the Empire, information the chairman wants to keep to himself, and operations of personal interest to him.

RA'TAR

Like the chairman of the *Tal Shiar*, the Praetor often classifies information under his personal seal, restricting access to himself and close advisors. When combined with the *Ruta* and *Vay'Ruta* classifications, the Praetor can restrict access to ever more trusted members of his coterie. Examples include various operations of interest to the Praetor (such as efforts to recover working Iconian technology), future political initiatives, and directives to assorted military and political personnel.

Using the Tal Shiar

The *Tal Shiar* is a constant presence in Romulan life. Every Romulan citizen knows (or at least suspects) that agents of the *Tal Shiar* are watching all the time, and act accordingly. Not everyone actually encounters the *Tal Shiar*, however. For most loyal citizens of the Empire, it is merely a presence, always in the background, but rarely taking action. Having the *Tal Shiar* step in to cause problems for the player characters in every story quickly diminishes its value as a mysterious and shadowy force behind the scenes. Far better for the players wondering about the extent of the *Tal Shiar's* knowledge and influence, with occasional cryptic clues that the *Tal Shiar* is observing and either approves or disapproves of the characters' behavior.

In a Federation-based game, the *Tal Shiar* makes a formidable adversary for Starfleet and its own Intelligence Division. Starship crews can encounter *Tal Shiar* covert agents and their plots throughout Federation space and beyond. The *Tal Shiar* is particularly interested in acquiring classified Starfleet technical information and in fomenting trouble between the Federation and the Klingon Empire, in hopes of destroying the alliance of the Khitomer Accords. Assigning a player character the role of a *Tal Shiar* "sleeping agent," someone brainwashed into carrying out certain orders without his conscious knowledge, could make for interesting roleplaying.

In a Romulan-based game, the *Tal Shiar* poses a perpetual threat hovering over everyone. Any acts of disloyalty are sure to be reported to it, and the *Tal Shiar* will react accordingly. It may not necessarily arrest the character, instead choosing to use the information as leverage for blackmail. Members of a Romulan crew constantly walk a fine line between loyalty to their shipmates and loyalty to the Empire, having to report any suspicious activity.

Occasionally, a *Tal Shiar* agent may take a direct hand in things, commandeering the player characters' ship for a covert mission, for example, or calling upon loyal soldiers of the Empire to assist in the arrest of a corrupt political or military official, perhaps even someone the characters trust and respect. Do they do as the *Tal Shiar* orders, or do they find some way to warn their friend? What happens if the *Tal Shiar* is right and he is a traitor to the Empire? A *Tal Shiar* agent who commandeers a Romulan ship will probably do so without any real explanation to the crew, and a mission for the *Tal Shiar* is certain to lead the characters into danger and intrigue.

THE TAL SHIAR CAMPAIGN

An interesting Romulan campaign can be based around the activities of the *Tal Shiar*, with the players taking the role of *Tal Shiar* agents and others affiliated with the organization (such as members of the Romulan military). Perhaps the characters form an elite team of *Tal Shiar* agents entrusted with difficult and dangerous covert missions by the Special Operations Division. The characters could go from putting down terrorist activities on Romulus itself to espionage missions into Federation or Klingon space in a cloaked ship, gathering vital information for the Empire.

A *Tal Shiar* game becomes most interesting when the player characters become entangled in the complex web of alliances and secret plans within the organization. The *Tal Shiar* is not well loved by most Romulans—respected and feared, certainly, but not appreciated or admired. The player characters must deal with the hostility of others who do not understand their work, particularly in the Romulan military. They also have to navigate the dangerous political alliances of the *Tal Shiar*, which seem to change on a daily basis.

Agents who make a mistake can often find themselves out in the cold. Perhaps the player characters, formerly loyal *Tal Shiar* agents, have been disavowed by the organization for some reason. The players have to figure out how their characters are going to survive without the support of their organization and its fearsome reputation. They might defect to the Federation, seek the support of a radical senator or other Romulan political figure, join the Romulan underground, or become mercenaries and work for some group like the Orion Syndicate or even the Ferengi Alliance.

On the reverse side of a *Tal Shiar* campaign, the player characters play the role of Federation agents assigned to infiltrate the *Tal Shiar*, disguised as Romulans. They might be Vulcans, or other humanoids surgically altered to appear as Romulans. Such agents face an extremely difficult task, since the *Tal Shiar* is especially paranoid, always on the lookout for unusual or potentially treasonous behavior. What lengths will the player characters go to in order to carry out their masquerade? What happens when they are assigned a mission by the *Tal Shiar* that may compromise the security of the Federation?

THE TOOLS OF CONQUEST



The Romulans possess a technology level similar to that of the Federation: Technological Classification Level Six. Most of their devices have the same basic operational functions and parameters as equipment throughout the major civilizations of the Alpha and Beta Quadrants. In their daily lives they use tricorders and PADD's, medical kits, communicators, and replicators. Their warships, scout craft, and research vessels employ transporters, warp and impulse drives, deflector shields, and tractor beams.

But when one thinks about Romulan breakthroughs in science, one recalls cloaking devices, neural conditioning devices, and warbirds powered by artificial quantum singularities—all developments fostered by the Romulans' strong emphasis on military and covert espionage actions. In their political and military dealings, Romulans pursue their goals through two strategies: Sometimes massive application of force is effective, and other times their secretive, surreptitious methods are more suitable. Their technology also follows these cultural trends.

Power is important for Romulans. They use raw energy from matter/anti-matter annihilation to operate many common devices, employ cloaking devices with enormous power-consumption requirements, and even pioneered a new energy source: tapping the near-infinite power from within an artificial quantum singularity. Security and secrecy are also Romulan values applied to technology. Their information-retrieval systems are protected by a variety of measures designed to provide access only to authorized individuals and to log data retrieval and modification. The *Tal Shiar* relies on technology to monitor security and to react covertly to threats.

Through the years Romulans have made many technological advances through careful research and experimentation. Some they took from the Federation and the Klingon Empire, developing their own versions through reverse engineering. While the *Tal Shiar* strives to uncover and steal new technology from its enemies, Romulan engineers work to adapt these alien breakthroughs to civilian and military applications. This frees time and resources for the most gifted Romulan scientists and institutions to research new fields and design devices with unforeseen advantages over existing Federation technology. Romulan engineers and strategists explore new scientific realms to help the Empire defend itself against its enemies, through both intense application of force and the complex subterfuge typical of Romulan operations.

Romulan Power

A trained and persistent observer can detect subtle differences between Romulan and Federation equipment. The greatest distinction comes from the energy sources used to operate their devices. The manner in which they generate, store, and relay energy causes variations in frequency and conversion levels. The subtle difference in power frequencies and equipment design are partially responsible for the distinctive green glow of Romulan transporter beams, warp field nacelles, tractor beams, and disruptor blasts.

Other differences are less visible, such as the anomalous discrepancies noticeable between items created by Federation and Romulan replicators. Only after close analysis and comparison could a trained observer distinguish the minor molecular variations characteristic of Romulan power signatures.

Most energy generated by Romulan sources is slightly more intense than Federation standards. Technology has adapted to this higher than usual power baseline: Components have evolved to handle these levels

and the unusually intense energy spikes accompanying their initial activation. For instance, discharge crystals in Romulan disruptors are more efficient to handle the highly charged plasma bolts generated by the weapon's small antimatter energy source. Other items, even personal equipment, are constructed to withstand the transference of higher-frequency power.

Romulans generate power through a variety of systems: matter/antimatter annihilation, fusion reactors, and in some civilian colony applications solar, hydroelectric, and geothermal methods. Although most of their spacefaring vessels since the 2270's use matter/antimatter reaction chambers in their engine cores, the immense *D'deridex*-class warbirds are powered by artificial quantum singularities (though they still carry stores of antimatter to energize disruptors and back-up systems). While this is highly efficient in space, at this time it is too dangerous for widespread civilian application. Fusion reactors still provide power for ion impulse drives, though these are slightly more efficient than Federation equivalents.

Although artificial quantum singularities power the massive warbirds, the Romulans still find the collision of antimatter with matter the most efficient source of energy for smaller applications. They use minute quantities of antimatter to power most devices, even at the personal level. Perhaps this is why Romulans have not actively pursued the sarium krellide technology which gives most Federation equipment the ability to recharge from other power sources.

Romulan devices draw energy from matter/antimatter power cartridges. Each cartridge is essentially a miniature magnetic containment vessel for the microscopic amounts of antimatter required to run personal devices. Although they cannot be recharged, these cells last longer than systems using sarium krellide induction coils to renew their energy.

To handle the large amounts of power generated by antimatter power cells, and the energy spikes associated with such systems, most components must be of higher tolerance than Federation equivalents. One might think this makes Romulan equipment more durable; instead, antimatter power cells are slightly more prone to cause malfunctions should an item sustain damage. Personal devices do not contain enough antimatter to cause deadly overloads, both for the user's safety and to keep seditious forces within the Romulan Empire from using them as weapons. During the course of its operational life, a power cartridge for a Romulan tricorder uses the equivalent energy needed to fire one low-intensity disruptor burst.

Devices using antimatter for power generate antiprotons, which are sometimes detectable by active scans during operation. Initial activation creates an energy spike which sensors can easily detect. A sensor sweep for antiprotons in a heavily populated region on Romulus would reveal a cloud of such power spikes from household appliances, personal data-access terminals, and other common items. Energy fields from large machinery show up on sensors more easily than those from smaller personal gear. High-powered equipment designed to release energy openly—like disruptors—leaves an antiproton residue in the area for several hours after discharge.

SECURITY CONCERNS

Romulan technology emphasizes security. The *Tal Shiar* maintains a firm grip on events inside and outside the Romulan Empire to ensure the government's stability and the people's prosperity. This sometimes paranoid obsession filters into many aspects of society. Starship control is limited by closely secured prefix codes and personal access clearances. Complex cipher keys safeguard government records. Personal security passwords known only to their owners protect PADD's and tricorders. Even school children learn simple data-encryption techniques and access-inhibitor protocols to protect their homework assignments.

The basis for most modern Romulan data security is a progressive encryption lock, a 43-point cipher key which, once decoded, allows entry into protected databases. The algorithms and mathematical sequences generating this key provide models for all other access codes. The main cipher key is nearly impossible to penetrate. To this day, Commander Data of the *U.S.S. Enterprise-D* is the only outsider to break this lock, with some assistance from Ambassador Spock. Romulan code theoreticians and the *Tal Shiar* have since modified the encryption key.

Most information retrieval systems rely on the basic concepts of this 43-point security code. Nearly any device accessing or recording data is protected from unauthorized tampering. Romulan computers, PADD's, tricorders, and other information-processing equipment have capabilities similar to equivalent Federation technology—they're just more aggressively protected. Although they possess voice-interface computers, Romulans tend to avoid verbal commands to prevent being overheard by unauthorized listeners (although such commands still require voice identity verification and verbal security codes). They prefer interacting with computers through control panels. Access to any control panel aboard a Romulan starship requires a personal code, sometimes even a departmental key and com-





mand clearance prefix. Government, scientific, military, and other vital computers contain the same security precautions. Even PADD's, tricorders, and certain other personal data devices require passwords and user verification.

Security clearance codes are input before informational systems can be activated or accessed, and users can reimplement them manually or when the access device is turned off. Some equipment includes an "idle security check" in the access subroutines. Should data access cease for a while, the programming automatically reimplements the security protocols. Depending on the device or computer system's clearance level, these "idle security checks" can occur after a preset time or a random interval.

Romulan security codes are changed frequently on irregular schedules. The Romulan government fosters a spirit of watchfulness against enemies, a paranoia manifesting itself in official passkey alterations to keep "enemy" agents from breaking access ciphers or using stolen ones. Some systems even require users to change entry codes at random intervals, allowing for more sophisticated security and encouraging a sense of responsibility in most citizens. Such protocols allow users to log in through their usual clearance and identification verification, but prohibit further action until the security ciphers are changed manually.

SECURITY CODE DIFFICULTIES

Here are some suggestions for determining difficulties to decrypt security sequences protecting data at various levels of Romulan society.

| Level | Difficulty |
|--------------|------------------------|
| Civilian | Routine (4) |
| Professional | Moderate (7) |
| Government | Challenging (11) |
| Military | Difficult (14) |
| Tal Shiar | Nearly Impossible (17) |

Most Romulan data-retrieval systems not only employ sensitive passwords, they also contain subroutines to monitor information access. These programs record who views which information and when in special, invisible log files. Security personnel have protocols allowing them to enter these hidden logs and examine data retrieval and modification. Few in the civilian sector know these subroutines exist. Government and military supervisors use these log protocols to track subordinates and computer records for which they're responsible. The *Tal Shiar* often uses this security subroutine in its work protecting Romulan citizens from external enemies and internal sedition.

Starship prefix codes are the Romulan Empire's most protected secrets. The Romulans are fiercely proud of their military might, especially their massive D'deridex-class warbirds and the advanced technology they employ. If enemies gained an unfair advantage over these vessels, they might capture the sensitive mechanisms that provide the warship's vast power and cloaking ability and later use it against the Romulan Empire. Security command codes are often known only by a ship's captain and the first officer. Key personnel in the Star Command can access prefix sequences in emergencies, though this often initiates a *Tal Shiar* inquiry into

TAL SHIAR SECURITY

The *Tal Shiar's* computers are protected by more advanced codes than available even to the military and higher-level government offices. These security precautions employ the next iteration of the progressive encryption lock safeguarding most Romulan computers. This newest upgrade merges an advanced 47-point cipher key with randomly progressive algorithmic sequences. Such precautions require substantially more computer memory and processing time for standard encryption and monitoring, so these codes protect only the largest and most sensitive *Tal Shiar* databases.

The *Tal Shiar* closely guards these newly developed ciphers, even though they could protect sensitive data in military and government circles. The *Tal Shiar* might someday disseminate these new codes for use in other applications, though this is doubtful until they develop something even more advanced.

The *Tal Shiar* recruited or abducted the Romulan Empire's greatest code theoreticians and mathematical geniuses to work at a secret facility dedicated solely to creating new security protocols. These scientists use their cutting-edge theories on random number generation, cipher design, and progressive algorithm locks to break others' security precautions and perfect the *Tal Shiar's* more powerful ciphers. Once they develop something new for the *Tal Shiar* to protect its own data, the secretive state security organization might pass its current precautions to the military. Even after that, the *Tal Shiar's* valuable code-masters will continue living in guarded seclusion.

the overt purpose and possible covert motivation for access. Among starship commands, rumors circulate of those suspected of revealing such codes to unauthorized personnel mysteriously disappearing. Many with clearance to sensitive information live in fear of the *Tal Shiar* abducting "traitors" and interring them in mythically terrifying prison camps, never to be seen or heard from again.

EQUIPMENT TERMINOLOGY

The personal equipment and weapon descriptions include short lists of traits with useful information on the item's size and mass. Additional categories may provide some of the following game statistics:

Damage: The amount of damage a weapon inflicts.

Duration: The length of time a device will operate before its power cartridge must be replaced. Most durations are listed in hours, but energy weapons list "Energy," the number of charges which may be consumed at different rates depending on the intensity settings. Unlike Federation devices, these Romulan items do not include any notation indicating they can be recharged.

Range: A beam weapon's limit for accurate fire is listed for point blank/short/medium/long range in meters. A sensor's range is the maximum distance at which it can detect and gather information on objects or energy patterns.

PERSONAL TECHNOLOGY

Most Romulan personal technology is similar to Federation equivalents. Although items run on microscopic amounts of antimatter contained in magnetically sealed power cartridges, their operational specifications vary only slightly from equipment available from other major cultures in the Alpha and Beta Quadrants. The difference in energy source often gives Romulan devices slightly longer working lives.

If you need a specific piece of Romulan equipment for your game not listed here, use information provided for similar devices in the *Star Trek: The Next Generation RPG's* "Technology" chapter. While the device's basic abilities will be about the same, Romulan items cannot be recharged from energy sources—the user must insert a new power cartridge into the device.

PERSONAL ACCESS DISPLAY DEVICE (PADD)

Romulans use PADD's for many daily applications: maintaining store manifests, writing correspondence, researching databases, teaching, playing games. They function as the most common personal computers and interface devices. Romulan PADD's have an oblong configuration with one diagonal side. In civilian sectors their use isn't as widespread as in the Federation, though professionals working with computers, the military, and the *Tal Shiar* rely on these devices for sharing, inputting, and accessing data. Romulan PADD's typically have shorter interface ranges, and must be closer to the system they're communicating with to prevent unauthorized monitoring of PADD transmitter signals.

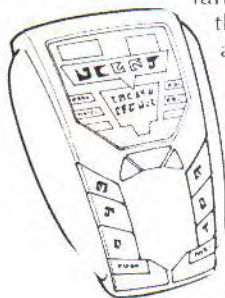

Each PADD is encoded to limit use to its owner or authorized personnel through a series of security protocols. Remotely accessing computer databases on a PADD imprints the user's identification sequence in a hidden security file.

Civilian PADD's do not contain long-range communications capabilities, though they can interface with nearby computers accessible to authorized users. Military versions of this device use a subspace transceiver to transmit to starships as far as 30,000 km away using the vessel's communications boosters; access encryption and sequence coding account for the shorter range.

Members of the *Tal Shiar* sometimes use smaller PADD's with fewer capabilities and greater limitations, though these are often protected with far more security protocols than ordinary devices.

Size: 16 cm x 7 cm x 1 cm

Mass: 0.2 kg

Duration: 150 hours

ROMULAN TRICORDERS

Romulan versions of personal sensor devices are quite similar to equipment used by the Federation, though they are more powerful and able to make more accurate sensor readings than Federation tricorders. There are standard tricorders and those modified for medical and engineering purposes.

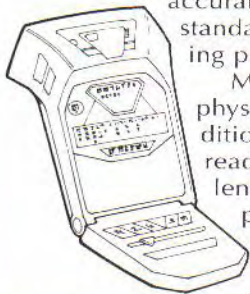

Medical tricorders are designed specifically with Romulan physiology in mind. They are not as effective in diagnosing conditions in patients of other species, and sometimes misinterpret readings, fitting them to the closest known Romulan equivalent. A detachable medical peripheral can help examine patients more closely.

Engineering tricorders are focused in areas typical of Romulan technology, such as cloaking devices and artificial quantum singularity drives, and can more effectively detect tachyons, antiprotons, gravitic variations, and other byproducts of distinctly Romulan devices. An engineering peripheral can be detached from the main tricorder for detailed analysis of energy fluctuations and other conditions within electronic systems.

Tricorders are security-locked with complex code sequences known only to their operators and their supervisors. Transmissions between tricorders and starships are also encrypted for additional protection.



Range: 2,000 meters for long-range scans, 25 meters for short-range scans, 2 meters for remote peripheral scans

Size: 8 cm x 16 cm x 2.5 cm; peripherals are 7 cm x 1.5 cm x 1.5 cm cylinders.

Mass: 0.45 kg

Duration: 1,500 hours

ROMULAN MEDICAL KIT

In the field, Romulan doctors rely on medical kits to implement first aid and stabilize major injuries. The medical kit is equipped with a hypospray, neural stimulator, dermal regenerator, and autosuture, plus several other antibiotics and medical accessories tailored to Romulan physiology. Most medical kits used by military and *Tal Shiar* units also contain several axonophagic chips (see "Espionage Technology" below) should severely injured patients wish a quick death rather than risk capture.

Since Romulan devices use antimatter power cartridges instead of sarium krellide induction coils, medical kits contain several extra cartridges. Most instruments in a Romulan medical kit perform the same functions as those in Federation gear. For game information on this equipment, refer to the *Star Trek: The Next Generation RPG* rulebook, pages 232-234.

Size: 22 cm x 19 cm x 6 cm

Mass: 1 kg

PERSONAL COMMUNICATOR

Romulans use several models of communicators, hand-held units which rely on radio and subspace transmissions to transfer voice data. The most common are palm-sized devices with a rounded cylindrical or elongated cube shape. Romulan communicators are often security-coded to the owner. Military and intelligence versions contain complex cryptographic encoding, making signals difficult to intercept and decipher.

Romulan communicators do not automati-



cally provide the user's location to scanners, although transporters can always lock onto active transmissions to beam an individual.

On their own, communicators have an effective range of 750 meters. The improved independent range is attributed to the device's antimatter power cartridge. Local communication arrays and starship subspace transceivers allow communicators to transmit more than 40,000 km, enough to reach orbiting facilities or vessels.

Size: 5 cm x 4 cm x 3 cm

Mass: 0.3 kg

Duration: 1,500 hours

DISRUPTORS

Romulan military, intelligence, and security forces favor the disruptor as their standard-issue energy weapon. When fired, microscopic amounts of antimatter rip through charged plasma focused through a discharge crystal. Depending on the setting, the resulting beam can stun a target with concussion and a mild neural shock, or cut through metal and inflict lethal thermal damage. A disruptor's discharge leaves a residue of antiprotons detectable on scanners for several hours, a byproduct of the antimatter energy powering the weapon.

Romulans use both pistol and rifle versions of disruptors. The rifle variant has a longer firing chamber, larger power cartridge, a forward hand grip to assist aiming, and a rear grip containing the trigger. Like other Romulan devices, disruptors cannot replenish their energy through recharging, but rely on new magnetically sealed antimatter power cartridges. Disruptor cartridges contain a greater amount of antimatter, and therefore energy, than those used to power other devices.

Disruptors can fire using one of three discharge modes:

- **Standard Beam:** The disruptor's default setting fires a standard energy beam, and uses the charges indicated on the Disruptor Damage Chart.
- **Pulse:** A disruptor pulse inflicts more damage than other

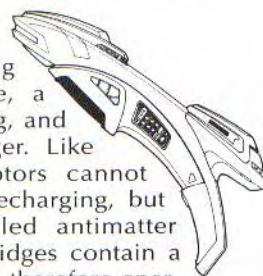

DISRUPTOR DAMAGE

| Setting | Damage | Charges |
|-----------------|------------|---------|
| 1 Light Stun | (2+2d6) | 1 |
| 2 Heavy Stun | (4+2d6) | 2 |
| 3 Light Thermal | (10+2d6) | 8 |
| 4 Heavy Thermal | (12+3d6) | 15 |
| 5 Light Disrupt | (24+5d6) | 35 |
| 6 Heavy Disrupt | (160+12d6) | 100 |

DISRUPTOR SETTINGS

| Setting | Notes |
|-----------------|---|
| 1 Light Stun | Stun a human for 5 minutes |
| 2 Heavy Stun | Stun a human for 15 minutes, or a Klingon for 5 minutes |
| 3 Light Thermal | Cut a 1 m hole in 10 cm of steel in 3 minutes |
| 4 Heavy Thermal | Cut a 1 m hole in 10 cm of steel or rock in 30 seconds; cut a 1 m hole in a duranium bulkhead in 10 minutes |
| 5 Light Disrupt | Vaporize almost any thing, including humanoids and resilient alloys |
| 6 Heavy Disrupt | Explode 600 cubic meters of rock into glowing rubble |



settings by releasing slightly more energy than usual. Pulse discharges add +1 point of damage, but consume two extra energy charges.

•**Continuous Beam:** In this mode the disruptor fires a longer beam, using more energy but providing greater accuracy. Continuous beams use two extra charges, but add one die to the character's Energy Weapon (Disruptor) Test to hit the target.

Setting a disruptor on overload generates energy from the matter/antimatter reaction without discharging it. To overload the weapon, one puts the disruptor on the highest setting for maximum antimatter output. The antimatter is released from the power cartridge to react with matter, but isn't discharged as a disruptor beam. In 30 seconds this reaction and what's left in the cartridge destroy the disruptor in a brilliant explosion consuming the remaining antimatter and charged plasma. The blast inflicts 1 point of damage for every charge left in the power cartridge, affecting anyone within a 4 meter radius.

Range: 5/20/50/100

Size: 20-30 cm long, 0.7-1.1 l in volume

Mass: 0.6-1.2 kg

Energy: 1,500 charges (pistol), 2,250 charges (rifle)

MELEE WEAPONS

The Romulans are not known for their melee weapons, few of which have been seen by non-Romulans. Many of these weapons possess a traditional or symbolic quality, as a link to the past. Some of the better-known Romulan weapons include:

VRELNEC

The *vrelnec* is the traditional Romulan sword. Although throughout Romulan history there have been dozens, if not hundreds, of sword designs, this one is the most popular and influential. It consists of a straight, single-edged blade about 110-120 cm long; the blade curves outward slightly at the tip. The hilt is similar to a basket hilt on an Earth sword; it protects the hand and is often elaborately decorated. Overall the *vrelnec* is similar to an Earth saber or cutlass, but its blade tends to be even heavier, increasing the damage it does but also preventing long duels (the wielder's arm tends to tire quickly). The traditional art of "fencing" with one of these swords is usually known as *vrelnecrek*.

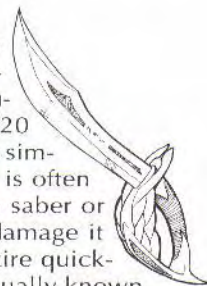

Mass: approximately 2.2 kg

Accuracy: 7

Block: +2

Damage: 5+2d6

NECA

The dagger form of the *vrelnec*, the *neca* resembles a smaller version of the sword (sometimes without the basket hilt). It uses the statistics for a Knife (page 238 of the core rulebook).

LIRASH

Scholars believe this weapon is descended from the Vulcan *lirpa*. It is a heavy fighting staff with a crescent-shaped blade on one end. It can be used either like a staff or large club, or something like a polearm. A master combines both uses of the weapon into a fluid, deadly fighting style.



Size: 150 cm long (the blade is about 12 cm wide)

Mass: 4.6 kg.

Accuracy: 8

Block: +3

Damage: 3+2d6 damage with either blade or club

KAILUNE

Resembling to human eyes something like a small metal profile of a bat in flight, the *kailune* is a throwing blade which Romulans once used to hunt for food or sport. It is sharp on all edges, the better to increase the chance of inflicting a wound on a target.

Although it is generally not powerful enough to kill an adult Romulan, some masters have demonstrated a lethal pinpoint accuracy with it. On rare occasions a *kailune's* ability to kill will be increased by coating it with poison.

Size: 12.5 cm long by 7 cm wide and just under 1 cm thick

Mass: .25 kg (at most)

Range: 5/10/20/35

Damage: 1+1d6

ESPIONAGE TECHNOLOGY

The *Tal Shiar* relies on technological breakthroughs to gain advantages over its enemies in the subtle yet deadly espionage war it wages. It exploits Romulan science better to protect the Empire in intelligence operations abroad and while controlling dissident groups or individuals at home.

Some espionage technology is used by the military, but most items, especially prototypes or powerful devices, are available only to *Tal Shiar* agents. Although Romulans are capable of using massive force to attain their aims, they prefer using more subtle methods. *Tal Shiar* scientists develop new devices to help operatives conduct undercover missions, and sow confusion among and gain advantages over the Romulan Empire's enemies.

ULTRITRIUM

Many advanced societies have the technology to manufacture *ultritrium*, a powerful chemical explosive almost undetectable by scanners. While the Federation does not resort to such covert methods of mass destruction, the Romulans have no qualms about using this chemical compound to their advantage. The *ultritrium* produced by Romulan scientists is particularly difficult to detect. The *Tal Shiar* finds the explosive effective when sudden force is required during missions where conventional weapons could easily be discovered. The Romulans also use it in safeguard devices, to destroy sensitive technology or information when it might fall into enemy hands.

Technicians can easily mold the plasticine compound into concealable forms or conventional objects, which usually pass for normal plastic or ceramic during cursory materials scans and diagnostics. Often only a very detailed molecular scan reveals the material's true nature. Skilled demolitions experts can mold malleable *ultritrium* into shaped charges to damage structures more effectively. Some Romulan scout ships are even equipped with secret *ultritrium* detonation systems to eliminate any evidence of espionage activities if captured.

When detonated, one thumb-sized cube of *ultritrium* inflicts 50 points of damage on anyone within 10 meters.

AXONOPHAGIC CHIP

Sometimes important Romulans must protect themselves from capture, lest enemies take advantage of sensitive data pried from their minds during interrogation.

Loyal Romulans would rather take their own lives than betray the Empire by succumbing to torture and revealing vital information.

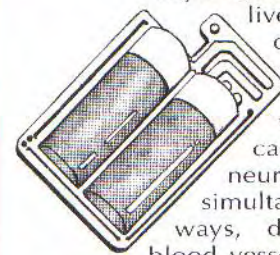

Axonophagic chips are small wafers containing lethal chemicals. When ingested, a chip causes neurons in the brain to fire almost simultaneously, burning synaptic pathways, destroying cells, hemorrhaging blood vessels, and inducing a quick death.

No cure exists. Even if one could be discovered, the initial reaction of the chemicals with the cortex's neural pathways destroys so much tissue that the individual would be effectively brain-dead.

Most *Tal Shiar* agents and many high-ranking Romulan military officers carry axonophagic chips for use if captured and facing interrogation. Death is preferable to torture or public humiliation for the proud Romulans.

HOLOGRAPHIC CONSTRUCT COMPUTER

Romulan security forces use holographic recorders to monitor public safety and possible insurrectionist activities, but the *Tal Shiar* has perfected hologram technology to manipulate information and perceptions.

The *Tal Shiar* is adept at altering basic holographic images for its own ends—such as scenes of crowds, landscapes, and starship actions—but did not always have the capability to create moving, speaking holograms of specific individuals.

The holographic construct computer pieces together images and sounds gathered from various monitoring sources to create an authentic hologram of a particular person, which can be manipulated to suit the *Tal Shiar's* purpose.

The computer constructs the image from data collected from security devices monitoring Romulan streets, transmissions, ships, and facilities. The more information gathered, the more genuine the holographic personality seems. With thorough data accumulation, the computer can create a very accurate, functioning hologram with the individual's voice, image, inflections, gestures, and other mannerisms. The process of piecing together visual and audio details through normal holographic monitoring devices takes time, but the *Tal Shiar* has the persistence and patience for such work.

Once the computer assembles the holographic person, it can project the image anywhere within a holographic projection system's range, not usually more than a few meters. This is often enough to fulfill the *Tal Shiar's* purposes, especially when the holographic individual delivers speeches or visually transmitted messages. The image speaks and acts according to programmed directions, including gestures and speech. Dialog is com-

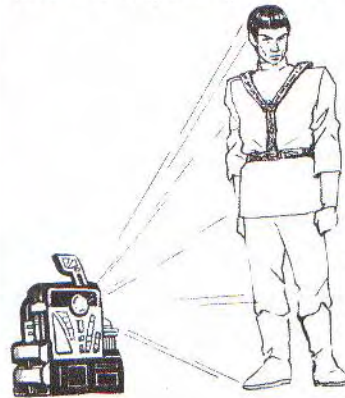

posed and transmitted to a holographic interface computer through a security-coded PADD or other interface. This technology has not yet advanced to allow the holograms to interact with real objects, so any accessories like PADD's, tricorders, or other hand-held devices are programmed into the projection computer.

The *Tal Shiar* finds many uses for holographic personalities. Several field contacts unknowingly report to a holographic spy master assembled from the image and voice of a Romulan civilian; should enemies intercept these transmissions, they might initiate a hunt for a high-ranking *Tal Shiar* administrator masquerading as a humble Romulan chef. Captured suspects can be holographically duplicated and forced to render transmitted "confessions" of treasonous acts, often to flush out coconspirators in hiding. The *Tal Shiar* even attempted to use a hologram of Vulcan Ambassador Spock to help disguise a Romulan attack force heading for Vulcan, though this plot was foiled by Spock, Captain Picard, and Commander Data.

PERSONAL JAMMING UNIT

Although the *Tal Shiar* has many devices to monitor communication signals, it must sometimes stop transmissions. The personal jamming unit is a far smaller version of similar equipment aboard Romulan starships. It floods an area with antileptons, which interfere with subspace transmissions. The concept works more effectively in space and with the more powerful energy sources aboard starships, but the *Tal Shiar* adapted it with limited success for personal applications.

Jamming units cram frequencies with interference with little discretion. All communications devices within range are affected, including PADD's and tricorders remotely transmitting to nearby computers. The energy required to generate antileptons limits the jammer's range and duration. Agents typically use these devices when fairly close to a target suspected of sending or receiving vital transmissions. Sometimes they are modified to work off standard civilian power supplies and planted near the area to be jammed, providing constant interference.

Jamming units are typically small, palm-sized devices, though they are most often concealed as tricorders, PADD's or other equipment.

Range: 25 meters

Size: 7 cm long, 0.2 l in volume

Mass: 0.2 kg

Duration: 10 hours

NEURAL REPROGRAMMING ARRAY

Sometimes it's not just enough for the *Tal Shiar* to capture an important person—to gain the best advantage, agents mentally condition and reprogram these captives to fulfill *Tal Shiar* objectives when returned to their normal environments. Trained interrogators know many brainwashing techniques, but the

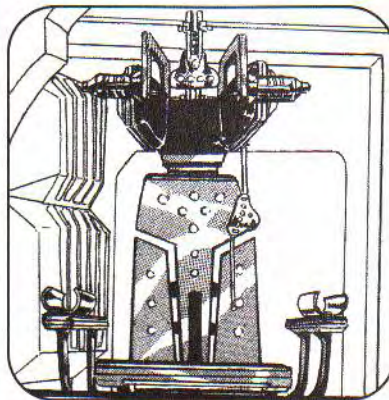

neural reprogramming array helps them more efficiently access the subject's mind.

The neural reprogramming array feeds stimuli directly to the brain to help break down the person's will and plant subconscious orders to be carried out later. Existing implants normally allow a sensory support device to interface with the appropriate portion of the subject's brain. The neural reprogramming array runs sensory information along this bio-electrical conduit. For instance, Romulans once used this array to reprogram Lieutenant Commander Geordi La Forge through his VISOR's neural implants, using images transmitted directly to his visual cortex. Since the array directly accesses the subject's brain, resistance is extremely difficult: a Difficult Behavior Modification (Resistance) feat against field control, or a Nearly Impossible one against trained *Tal Shiar* reprogrammers with time and resources to spend.

The array is mounted on an interrogation restraint chair so interrogators may easily position it over the subject's head. Two adjustable interface arms fit over

the individual's neural implants to force suggestive input straight to the cortex.

An imaging computer allows interrogators to select thousands of stimuli, both pleasant and painful, plus impressions of specific target individuals or facilities integral to achieving the implanted objective. With verbal prodding from the interrogator, this helps break down the subject's willpower and open his subconscious to suggestion. Since the information is transmitted directly to the cortex, the brain cannot easily distinguish between real and suggested input. The subject physically reacts with relaxed or stressed responses appropriate to the stimuli.

Once the interrogator conquers the subject's willpower, he can insert subconscious suggestions, which can be carried out without the subject's conscious knowledge. This often includes behavior uncharacteristic of the individual: gathering and transmitting restricted data, assassinating a dignitary, sabotaging a facility, or other criminal acts. After these suggestions are implanted, *Tal Shiar* interrogators can even convince the subject to believe different memories to account for his time during abduction and conditioning.

Once returned to his standard environment, the subject acts quite normally, totally unaware of his programming through Romulan behavioral modification techniques. With existing neural implants, there is no obvious physical evidence. Close scans of the brain, however, can reveal minor vascular irregularities in the cortex: a slight dilation of the blood vessels in the reprogrammed area. Other side effects can occur. Vivid images from the torturous destruction of the subject's willpower can haunt his dreams, causing violent and seemingly inexplicable nightmares. The individual's actions might be influenced by his programmed objectives—for instance, he could act out grudges against people used as examples in his conditioning, or develop an unexplained fear of something used to break down his will.

In the field, the *Tal Shiar* controls the subject through short-range e-band transmissions and additional verbal suggestions. This often requires a Romulan agent close by with easy access to the individual, who already has been conditioned to respond to this operative's signals and verbal commands. The e-band transmissions are within the delta-compressed wavelength spectrum similar to human neural frequencies, and can bio-electrically interact with human brain wave patterns. This interface requires a sensory support device feeding into the neural implants (or sometimes an independent implant). Commands from the transmitter must be relatively simple: report to the Romulan agent, identify a target, and act on conditioned orders. The transmitter is relatively small, a palm-sized unit which can be concealed as another common electronic device. Large sensor arrays can detect the e-band signals, though they cannot pinpoint their origins.

When under the influence of this conditioning and the e-band transmissions, the subject is incapable of controlling his own responses. The subconscious mental programming takes over, and he carries out his orders without question.

Individuals later require extensive psychoanalytical rehabilitation to regain their eroded willpower, purge the mental programming, and overcome conditioned memories and recover lost ones.

To use the array to manipulate mentally those without neural implants and sensory aid devices, the Romulans must surgically establish a bio-electrical

interface, which is later removed from the subject after conditioning. This method does not yield as effective results as using existing neural implants. Surgery on the cerebral cortex is always risky, and is more easily detectable by doctors once the individual returns to the field. Such subjects also receive a tiny electronic controller implanted near the cortex to receive and interpret controlling e-band transmissions.

STARSHIP TECHNOLOGIES

Many systems aboard Romulan starships are similar to those on Starfleet vessels. This can be attributed to scientific developments following parallel courses, and the Romulan penchant for acquiring foreign technology and adapting it for their own use. In many cases, most Romulan starship functions are the same as those aboard Starfleet ships. Reference the "Starship Technologies" section in the *Star Trek: The Next Generation RPG* rulebook (pages 238-247) for more information.

Romulan starships still possess several significant differences, including their infamous cloaking devices and efficient artificial quantum singularities. These reflect the Romulan warrior ethic of both stealth and massive application of force.

Bridge stations control many of the same operations as on Federation vessels. Most configurations place these in front of the captain's chair and command console to keep activities hidden during visual communications between starship commanders. Control panels throughout Romulan ships are security-coded to authorized individuals and their supervisors, and follow extremely cautious data-protection conventions. The emblem of the Romulan Empire is prominently displayed behind the captain's chair to intimidate others. The bird-of-prey device, representing *D'era*, is also found adorning key locations in the ship to inspire loyalty and remind crew members of their proud and glorious heritage.

The impulse and warp-drive systems function on the same principles which propel other starships throughout the galaxy. Excepting the mammoth *D'deridex*-class warbirds, most Romulan ships, including science and scout vessels, use matter/antimatter warp cores for their main power. Should the warp core sustain irreparable damage and threaten to breach, it can be isolated and ejected into space. Unlike Federation ships, which jettison their warp cores ventrally, Romulan ships eject their cores dorsally, sending them upward and forward from the vessel. Engineers claim this is best for protecting the ship from the exploding warp core, but tacticians theorize it serves as a last-ditch weapon during face-to-face confrontations.

Romulan warships use both plasma torpedoes and disruptors, the latter using much the same technological principles as their hand-held equivalent on an astronomically greater scale. Like phasers, shipboard disruptors can be set to fire at different intensity levels, to inflict lethal damage to an enemy or simply deliver a "tap on the shoulder" to intimidate the opponent.

Tachyon scan sensor technology gives Romulan sensors a slight edge over Federation equivalents. Cloaked ships hiding in a nebula can be detected with a tachyon scan; to prevent collisions, Romulans use a similar method with much shorter range to monitor locations of cloaked vessels traveling in formation.

Warships are outfitted with dedicated communications jamming units to keep opponents from calling for



THE ROMULAN ASTROPHYSICAL ACADEMY

Although several science institutions are renowned in the Empire, none are more prestigious than the Romulan Astrophysical Academy. Its past members are responsible for many milestones in Romulan interstellar development, including reverse-engineering warp drive from the Klingon *D7*'s of the alliance era, and inventing cloaking devices and artificial quantum singularities.

The main administrative and library facility on Romulus is a monument to the Empire's scientific achievements in space and a repository of astrophysical knowledge. The Academy headquarters also contains one of the planet's largest museums extolling the virtues and glory of Romulan technical advancements, at least those with low enough security clearance for view by the average citizen.

The Academy maintains several branches and research facilities throughout the Empire. Its scientists work in tandem with the Romulan military, some even laboring secretly for the *Tal Shiar*. Academy members serve aboard Romulan science vessels, orbital research stations, and planetside laboratories. Their projects range from developing more efficient propulsion systems to designing new tactical systems and advanced starship weaponry.

Before acceptance as an Academy fellow, members must pass extensive security and loyalty evaluations. Many scientists are drawn from the military, so they are already indoctrinated with the disciplines of secrecy and patriotism. Only the most exceptional researchers with questionable dedication to the Romulan Empire are admitted, and they are often relegated to low-clearance projects.

The Academy fosters the largest scientific clique in Romulan society. It offers scholarships to major universities for promising students, and sponsors representatives on military recruiting boards to allow exceptions for potentially gifted scientists. Academy members rarely mingle with common researchers, lest information about their classified projects leaks to unauthorized ears.

assistance or reporting on Romulan activities. These short-range jamming arrays saturate an area with antileptons, which essentially block subspace transmissions. The antilepton emitters have a 40,000 km range.

ARTIFICIAL QUANTUM SINGULARITIES

The massive *D'deridex*-class warbirds derive their energy from radiation generated by artificial quantum singularities: black holes generated, contained, and harnessed within the starship's power core. This drive mechanism comes from the old Romulan "magnetic bottle" method of propelling warbirds across light years, but vastly improved and capable of multiple uses and being contained within a ship hull.

Engineers create these amazing energy sources at deep-space construction stations far from the Federation's prying sensors and any Romulan settlements (in case an accident should occur). These large installations include starship docks for warbird construction, and the enormous power sources required to energize fields required to contain potentially explosive reactions.

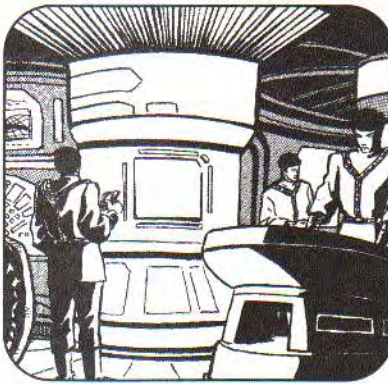

Each drive consists of an immense containment structure which holds the initial fusion reaction, induces a collapsar, and seals the quantum singularity once created. The singularity is induced inside the containment structure in the warbird; once initiated, it cannot be deactivated.

A graviton field helps contain fusing hydrogen isotopes to form a small, independently fueled star. This fusion reaction is compacted when the graviton field is increased exponentially, causing it to burn out and fall in on itself, creating a collapsed star, or collapsar. The gravitational forces are so strong that they compact into a single point, the quantum singularity. Quantum fluctuations at the singularity emit virtual particle pairs. The black hole's curved space absorbs one particle of each pair, but the other escapes as radiation used to power the ship. Matter fed into the singularity perpetuates the reaction.

Although they rely on quantum singularity power sources, warbirds still carry antimatter to energize disruptors and other appropriate systems.

CLOAKING DEVICES

Romulans are known for employing cloaking devices to render their ships invisible to enemy sensors. Strategically placed gravity field generators create an energy screen to warp light and other radiation around the hull. Engineers designed the *D'deridex*-class warbird in a configuration most suitable for cloaking devices, giving it as many smooth, convergent lines as possible.

Although the Romulan cloaking device is superior in many ways to similar Klingon developments, it is still prone to many limitations. It consumes so much power that a ship cannot energize weapons systems, shields, or transporters while the cloak is engaged. Even when the cloak is lowered, there is a tiny multisecond delay before the power can sufficiently charge shield and weapon systems. These massive energy requirements also dictate cloaking tactics. Romulan vessels do not swoop in and out of cloak, but place themselves carefully, decloaking in an advantageous tactical position and cloaking only when a confrontation is resolved.

Innovative Starfleet personnel recently discovered several ways to detect cloaked vessels. Several starships transmitting active tachyon beams can create a grid to detect cloaked ships passing through the network. Cloaked ships traveling at warp speeds generate a slight subspace variance visible to sensors. Gravitic sensor nets can scan variations from the cloaking device's field generators. Antiproton beams have also proved effective at revealing cloaked ships. Romulan engineers

constantly strive to upgrade the capabilities of existing cloaking devices to overcome these deficiencies.

DEVELOPING SCIENCES

The Romulans devote huge amounts of time, money, and resources to developing new sciences and cutting-edge technology. Their society's emphasis on *D'era* focuses most research efforts on military and espionage advancements.

The average Romulan citizen rarely hears about new scientific developments until the technology is adapted to everyday applications. Even some in the Romulan Senate and military aren't always cleared for knowledge of these classified projects. These are the Romulan Star Empire's secret weapons meant to gain advantages over its opponents and sow confusion, disinformation, and internal strife among those who oppose its expansion.

SMALL-SCALE CLOAKING DEVICES

For years, Romulan scientists have been working to adapt the cloaking technology to more widespread applications. Their goal: to construct cloaking devices capable of obscuring buildings and individual soldiers and agents. The initial problem with adapting cloaking technology involved interactions with a planet's atmosphere. The density of air particles made the cloaking device's tetryon emissions much easier to detect, and produced an obvious atmospheric rippling effect. Recently, these researchers largely solved this problem by adjusting the harmonics, geometry, and nutation used by the cloaking device. The Romulans have only recently begun to deploy these devices in the field.

HOLOGRAPHIC CAMOUFLAGE

Although the scientists at *Tal Shiar* Research and Development have been able to adapt cloaking technology to atmospheric use, and significantly reduced the device's size and power requirements, a personal cloaking device continues to elude them. In the interim, Romulan scientists approached the problem from a different direction, resulting in the development of this prototype holographic camouflage suit for use by agents in the field. The *Tal Shiar* has yet to share this innovation with the Romulan military, and the military remains unaware of its existence and deployment.

This garment employs an intricate sensor web worked into the fabric to sense the wearer's movements and adjust the holographic field accordingly. The suit consists of a one-piece jumpsuit, boots, removable gloves, and a hooded facemask. A small holographic unit and matter/antimatter power cell is housed in a lightweight tritanium backpack assembly. The suit employs an integral sonic dampener to dampen sounds made by the wearer, though this is less effective than the holographic illusion; make a Challenging (11) sound-based Search Test to hear the wearer. The holographic camouflage suit does not affect the firing of hand weapons, providing a tactical advantage. The Federation uses a similar device in their surveys of primitive cultures. Unlike the Romulan version, however, the Federation survey suit transmits a homing signal and does not affect radiation wavelengths in the lower and upper ends of the spectrum (infra red, X-ray, etc.), allowing the Federation to keep track of personnel.

The Romulan holographic camouflage suit is not infallible. Strong shocks to the outer casing can cause

the device to malfunction momentarily. While the device renders the wearer invisible to the eye and most sensor systems, it does not obscure signs of passage; the wearer leaves behind footprints, for example, when walking through snow, mud, or sand. Tears to the garment compromise the suit's effectiveness, as does removing any part of the suit. Romulan scientists have noted that the power source's antiproton and tetryon emissions can be detected by a tricorder set to scan for these particles. Despite these setbacks, the *Tal Shiar* employs holographic camouflage devices on a trial basis. Scientists continue to work at further miniaturizing this device, to get it down to the size of a tricorder.

Holographic suits typically provide the wearer with a cloak factor of 4, adding +4 to the difficulty to locate the individual with sensors or senses.

Size: A full-body jumpsuit 2 mm thick

Mass: 6 kg

Armor: [1] (Damage exceeding the suit's armor value tears the garment, reducing the cloak factor by one)

Duration: 6 hours

PHASED CLOAKING DEVICE

The Romulans continue to develop more powerful cloaking devices less detectable to sensor systems. Their most recent line of research dabbles in merging a molecular phase inverter with a cloaking device to produce a field which would both conceal a ship and allow it to pass through normal matter.

The combined device, called an interphase generator, cloaks and phases matter. So far researchers have encountered difficulties in controlling the generator's area of effect and the duration of phasing. Although they make headway in this new science, it is far from effective, practical, and widespread application.

Romulan scientists believe phased matter partially exists on a parallel spatial plane, making it undetectable to sensors and able to pass through other matter. Phased matter isn't antimatter—its molecular structure is inverted, unaligned with regular matter. Interaction between phased and nonphased matter is minimized: Sound doesn't register, light doesn't reflect off phased matter, energy passes through without effect. It is essentially invisible and noncorporeal from normal matter's perspective. A phased starship would be virtually invisible to nonphased vessels' sensors. Successful phasing would allow a ship to pass through normal matter and ignore effects of nonphased energy, including phaser blasts and photon torpedoes.

Phased matter interacting with regular matter creates harmless chroniton particles and fields, which are easily dispersed by an anyon beam. High intensity anyon beams are capable of rephasing matter into its original state. Phased energy creates much stronger chroniton fields than phased material when passing through non-phased matter. Focused sensors would detect the small chroniton fields generated by phased and nonphased matter interaction. The chroniton fields from phased energy passing through regular molecules is so much greater that most sensors immediately notice it. Romulan scientists continue to experiment with the interphase generator's many possibilities, though few provide enough positive results to outweigh the many difficulties.

The interphase generator has massive energy requirements which often strain its power source. Feedback



spikes are frequent and not easily predicted. This dangerous new technology has so far been tested only in space aboard a handful of high-security Romulan science vessels. Here any adverse interphase effects and dangerous power overloads can be contained and concealed from prying eyes.

PORTABLE CLOAKING GENERATOR

These devices are capable of projecting large-scale cloaking fields around an area, usually a small military encampment or planetary base, and concealing it from view. The cloaking device provides protection only to the structure itself; anyone stepping outside immediately becomes visible. As with ship-deployed devices, this cloaking device generates an energy screen capable of bending light rays around the object, rendering it invisible. If used to conceal a building in a dense forest, for example, casual observers would only see trees and underbrush. The cloaking generator does not alter the mass and density of the object concealed, so it is possible to walk inadvertently into a cloaked structure.

A single portable cloak can conceal an area up to 20,000 square feet. Larger buildings can be concealed through the use of multiple cloaking generators. While this device effectively renders a structure invisible to the naked eye and most sensor sweeps, certain types of scan can detect the use of a cloaking generator. Cloaking devices emit discrete amounts of tetryon particles, which in space can be difficult to detect because of background radiation. Most atmospheres screen out these harmful wavelengths, making it easier to detect the presence of tetryons. Fortunately, Federation and Klingon scanners and tricorders must be calibrated to register tetryons. Romulan scientists continue to work on the problem, by reducing the cloaking device's signature bleed.

Portable cloaking devices have a cloak factor of 5, adding +5 to the difficulty to locate the facility.

When used on starships, cloaking devices take advantage of the ship's maneuverability; it is nearly impossible to target a cloaked ship in the vastness of space. If a random shot connects with the target, the ship can move to avoid further damage. This is not so with a static target. Once a cloaked structure has been successfully located, an attacker can target it for further attacks. Unfortunately, the cloaking generator suffers from the same setback as a standard cloak—it cannot be protected by both a shield and cloak.

The cloaking generator receives power directly from the building's power source, commonly a fusion generator, though it can be hooked into a standard urban power grid.

Size: 80 cm x 50 cm x 50 cm box (200 liters)

Mass: 140 kg

Duration: Unlimited

POST-ACTIVE BIOWEAPON AGENT

The *Tal Shiar* always seeks swift and covert ways to dominate its enemies. The post-active bioweapon agent program is one such plan. Code-named SALKAR among Romulan military and intelligence personnel connected

with the program, the development of this bioweapon is conducted under the strictest secrecy at a remote research outpost on Voilina IV.

Post-active bioweapon agents consist of separated biotoxin components which must be combined or otherwise stimulated to become active. On their own, the individual biochemicals are harmless, easily passing through a transporter's biofilter. When the delivery device, usually a torpedo casing, reaches its target, it releases the components into a mixing chamber. The combined biochemical components form virulent strains of bacteria or vires which quickly spread through the target area.

Romulan scientists at first developed several bioagents which formed from separate, inert substances. They're currently striving to improve these bioweapons to generate fast-spreading airborne vires—these must work fast enough to infect a ship's crew before the contaminated atmosphere could be isolated in a biocontainment field or filtered through the vessel's photosynthetic processing and particulate filtration systems.

Voilina IV is void of life except for the lab facility and its personnel. The scientists are not foolhardy enough to test their bioweapons on the planet's surface, though they use containment fields and pressurized test chambers in the laboratories. A *D'deridex*-class warbird on patrol in the region often stops at Voilina IV and sometimes carries out experiments on the bioweapon agents and delivery system on other planets nearby.

Although the scientists progress with their research, the SALKAR project still has one challenge to overcome: The delivery torpedoes tend to break up upon impact, mixing only a small amount of biotoxin. Romulan scientists are currently considering two delivery methods. The first involves determining a starships' shield nutation, then beaming the delivery torpedo through during the fraction of a second while the shield rotates through its harmonics. The second delivery means involves Elway's theorem of interdimensional folded space transport, allowing the delivery torpedo to be beamed over incredible distances with precise accuracy. While travel using this means caused irreversible damage to humanoid test subjects, this is less a problem with inanimate matter.

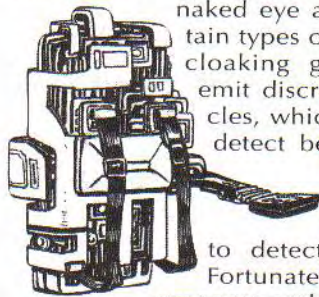

BIRDS OF PREY



Like the Federation Starfleet, the Romulan Star Navy utilizes a wide range of vessels and ship classes; unlike Starfleet, the Star Navy designs a disproportionate number of these ship types to fulfill military profiles. While ship classes dedicated to research and exploration profiles have become more common in the mid- to late 24th century, the primary focus of Romulan starship development remains an offensive exercise.

Romulan starship design and development has entered something of a renaissance in the latter half of the 24th century. Many factors have contributed to this evolution, including the introduction and heightened development of dedicated military vessels in the Federation Starfleet, the growing Taurhai threat along the Empire's rimward frontier, and the galaxy-threatening Dominion menace in the Alpha Quadrant.

Competition among research arms within the Romulan military has also served to accelerate starship development, with scientists and designers from the Star Command competing against those attached to the various senatorial or sector fleets. Such competition remains good-natured, and in the long run the resulting technologies benefit the Empire.

New hull and spaceframe composites, simpler and more stable hull layering techniques, sophisticated new shielding fields for quantum nacelles (thus eliminating many of the former hazards of these drive systems), advances in cloaking efficiency and performance—while keeping technologically apace of its enemies and neighbors is never simple, the Star Navy continues to develop and field many of the most advanced vessels in the galaxy.

The heightened threat environment of the late 24th century has fostered a kind of pervasive paranoia throughout both the Star Navy and the Empire. After many long years of isolation, a newly open Romulan people often feel beset by threats and challenges on every frontier. As a result, military spending has reached an all-time high, with hundreds of new vessels entering service each year. This situation tends to be exacerbated by additional spending on senatorial fleets and in Imperial hinterlands. The result is the largest standing fleet ever known in the Star Empire, but one that is perhaps less integrated than it should be.

In some ways, the current Tribunal appears to be playing a game of operational catch-up, responding to threats both internal and external. Unrest simmers among the colonies of the Empty Frontier, the climate along the Taurhai border remains tense and calculated, and the outcome of the Dominion conflict is far from certain. It is a time of challenges, a time for courage, a time that will test every officer's commitment to *D'era*.

Vessels of the Star Navy

While the Romulan Star Navy fields roughly the same number of ship classes as Starfleet, a greater proportion of these classes consist of dedicated military designs. Like the ships of Starfleet, most Romulan ships are classified according to their primary mission profiles. Because Romulan vessel classes tend to be more highly specialized than their Starfleet counterparts, their mission-specific roles tend to simplify the classification and design processes.

Descended from several experimental battleship classes that never saw mass production, the new *Vereleus*-class dreadnoughts represent the first in a planned series of massive, heavily armed, mobile command

centers. Designed to direct fleet operations and strategic movements from the front lines of a battle, these imposing vessels have already provided the impetus for some sweeping changes to Naval battle orders and integrated fleet response plans. The proposed *Praetorian* class is scheduled to enter production in 2379.

The ships of the numerous warbird classes have undergone a significant evolution during the 24th century as well. Originally designed as the quintessential ships of the line, capable of extended deep-space missions and carrying heavy armaments, the newer warbird classes have become both more specialized and more diverse. The new swift warbird classes, in particular, have redefined the nature and organization of Romulan rapid-response fleets and perimeter defense operations. In addition to a proposed upgrade program for the now-legendary *D'deridex* class (scheduled to begin in 2377), several new warbird classes are currently on drawing boards throughout Imperial naval yards. The first of these new classes—the *T'kassan* class of strike warbirds—will enter active duty near the end of the decade.

A radical departure from centuries of dedicated military vessel design, the new starbird classes of exploration ships continue to enter service at an aggressive rate. Proving that a place exists for specialized deep-space exploration vessels, several new starbird classes and variants are currently in the planning or development stages. More economical to produce than their larger and more heavily armed cousins, the starbird classes stand as a collective testament to the new spirit of openness currently gaining strength in the Romulan military. They represent a willingness to change and adapt previously foreign to most officers and commanders. The newest and most ambitious starbird design to date—the vast *T'kairin* generation cruiser—will be commissioned in early 2378.

Romulan cruiser classes tend to be less important than their Starfleet counterparts. Since the larger warbird classes account for most line vessel duties and missions, the Star Navy normally builds its cruisers with speed and stealth in mind. Although other profiles exist (such as the perimeter defense vessels assigned to many frontier outposts), most cruiser types are incursion, reconnaissance, or search-and-destroy vessels of some type. These ships are commonly employed to test enemy resolve along tense borders or in active threat regions.

Frigates fill many of the same roles as their Starfleet counterparts—escort, patrol, rapid response and deployment, etc. In the Star Navy, many frigate classes are specifically designed to support planetary occupation and pacification missions, and thus possess enhanced close orbital and atmospheric performance enhancements. The Star Navy also builds specialized mobile weapons platforms called gunships. Similar to the feared Cardassian destroyer classes, these ships are essentially frigates with very heavy armaments and defenses. Romulan gunships often sacrifice drive and propulsion capability for increased offensive and defensive capabilities—in such cases, vast carriers transport the vessels to threat regions where they are needed. These ships are normally key participants in planetary occupation missions, since their lack of maneuverability hampers their ability to act as effective space-based combatants against species with similar technology. For this reason, they are primarily used as pacification tools against less-developed worlds.

The Romulans build no dedicated escort classes, viewing the role of such vessels as secondary to the primary goal of any mission or battle. However, they do build small, fast ships roughly analogous to many of the heavier Starfleet escort ship types. Called birds of prey (a reference to their cloaking tactics), these small, quick vessels rely on stealth to penetrate enemy defenses. Used primarily as short-range observation, reconnaissance, and ambush craft, most fleets have a wing of such vessels attached to them. No new bird-of-prey classes have been commissioned in some time. This will change in late 2376, when the new *Vithrel*-class swift bird of prey enters active production.

Much like the various starbird classes of exploratory ships, the Star Navy did not build large numbers of scout vessels until recently. The resurgence of the type resulted from two primary factors: First, the vessels could be built economically, a concern in a continually expanding empire whose resources often did not keep pace with its needs; second, the changing threat climate of the 24th century required more vigilance on more frontiers than ever before. Greater numbers of reconnaissance vessels would allow rapid response and perimeter defense fleets to remain at strategic locations, to be dispatched only when their presence became necessary. Today, more

ROMULAN VESSELS

Birds of Prey

Ganum-class Bird of Prey
Vithrel-class Swift Bird of Prey (proposed)

Cruisers

T'kairin-class Generation Cruiser (proposed)
Nalvek-class Heavy Cruiser
D'viret-class Incursion Cruiser
Meret-class Incursion Cruiser
Vercaal-class Light Cruiser
Prelar-class Swift Cruiser

Dreadnoughts

Vereleus-class Dreadnought
Praetorian-class Dreadnought (proposed)

Frigates

Serex-class Heavy Frigate
D'virin-class Incursion Frigate
D'theros-class Light Frigate
Thalan-class Swift Frigate
D'tavan-class Strike Frigate

Gunships

D'gerok-class Assault Gunship
Vadak-class Heavy Gunship
V'gurin-class Sublight Gunship

Scouts

Kelkarrum-class Scout
Tirethi-class Far Scout
Deresus-class Heavy Scout
Nir'at-class Heavy Scout

Specialized

Theron-class Far Courier
Theta-class Swift Courier
Vasteme-class Gunship Carrier
Phaeros-class Medical Cruiser
Horos-class Far Surveyor

Starbirds

Ralek-class Starbird
V'tana-class Far Starbird
Vidian-class Heavy Starbird
T'rasus-class Light Starbird

Support/Auxiliary

D'seren-class Fleet Tender
V'geren-class Armored Transport
Sethen-class Cargo Transport
Veranal-class Occupation Transport

Warbirds

T'korex-class Warbird
V'tir-class Warbird
D'deridex-class Heavy Warbird
D'vanga-class Heavy Warbird
D'sera-class Light Warbird
D'valek-class Swift Warbird
T'varo-class Swift Warbird
T'kassan-class Strike Warbird (proposed)



scouts are produced than any other ship type, and ships of the numerous scout classes serve with distinction in every corner of the Empire.

In addition to the primary ship types, a wide variety of specialized and auxiliary vessels fill innumerable support roles in every fleet of the Star Navy. From long-range fleet tenders to gunship carriers to troop transports, the continued success and utility of Naval operations often depends on the support craft involved.

The Star Navy has commissioned more new ship classes in the latter decades of the 24th century than at any other time in the history of the Empire. Driven in part by the guiding precepts of *D'era*, and in part by new tensions on every border, the Empire has begun to shore up its defenses even as it continues to expand. A new age of Imperial openness has also become an age of increased vigilance as the Star Navy prepares for the new century.

A NOTE ON VESSEL PREFIXES

The Star Navy does not use prefixes before vessel names (such as the U.S.S. used by Starfleet, or the I.K.S. used by the Imperial Klingon Defense Forces). Instead, most vessels are simply referred to by name. When a situation calls for further distinction, the Navy employs fleet suffixes. For example, if the *T'vir* were a member of Senator Kassus' fleet, it would be referred to as the *T'vir Kassus*. The *D'dereq*, a warbird assigned to the Praetorian Fleet, would become the *D'dereq Praetorian*.



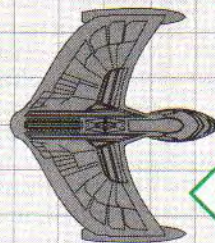
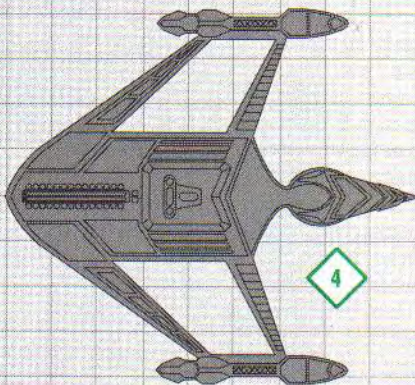
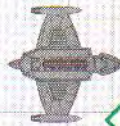
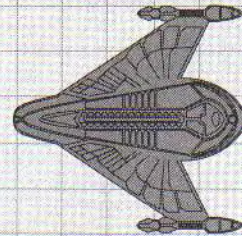
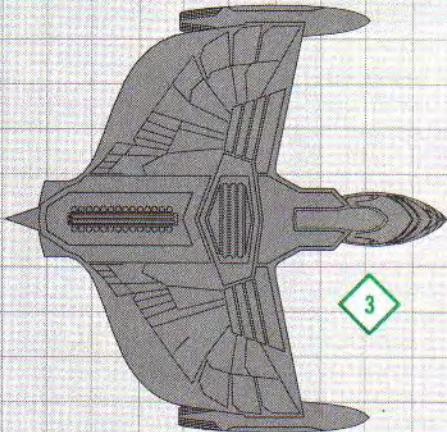
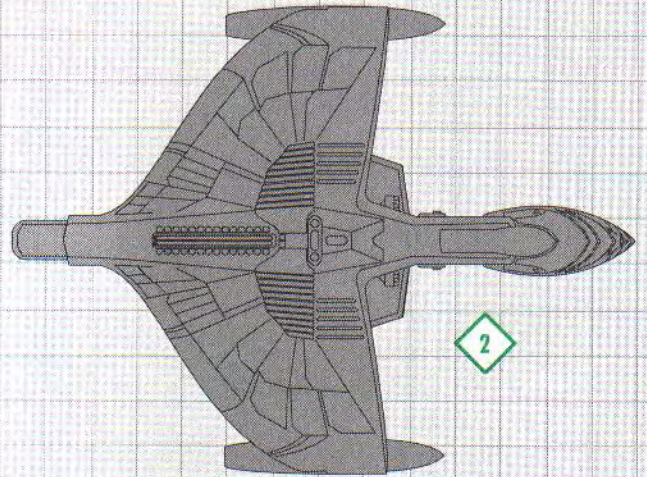
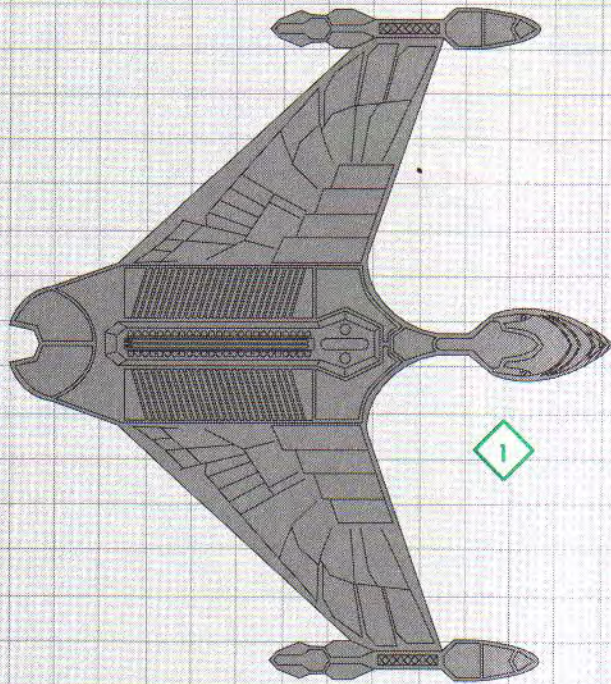

ROMULAN VESSELS

Size Reference

- 1] Vereleus class
- 2] D'deridex class
- 3] D'valek class
- 4] Meret class
- 5] T'rasus class
- 6] D'virin class
- 7] Deresus class
- 8] Theta class

THETA-CLASS SWIFT COURIER

Class and Type: *Theta*-class Swift Courier

Commissioning Date: 2337

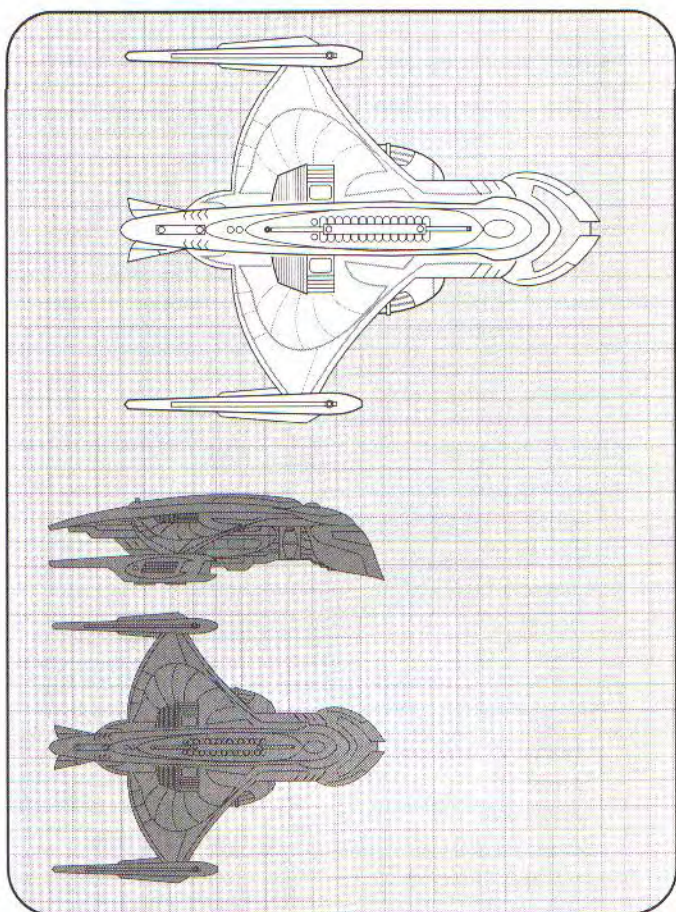

HULL CHARACTERISTICS

Size: 3 (73 meters long, 3 decks)

Resistance: 2

Structural Points: 60

DESCRIPTION AND NOTES

Fleet Data: One of the few nonmilitary profiles in active Naval service, *Theta*-class couriers transport sensitive materials, personnel, or information among the fleets and outposts of the Star Navy. Possessing light armaments and enhanced drive and propulsion systems, these vessels saw frequent use along both the Taurhai and Klingon borders during the 2340's and '50's, and along the route into the Alpha Quadrant during the Dominion War in the 2370's. They remain one of the quickest and most functional designs in the Star Navy.

Although considered the cutting edge of speed and utility in the early to mid-24th century, the *Theta* class has largely been replaced by the newer *Theron*-class far courier (which was first introduced in 2364). Many *Theta*-class ships remain in use either as frontier transports or training vessels; others have been refit by the Occupation and Pacification Commands, and are used as transports or regional couriers during planetary assimilation operations.

Noteworthy vessels/service records/encounters: *Theta*, prototype; *Rilidam*, lost on diplomatic mission near Federation Neutral Zone border; *S'narvak*, currently assigned to core world outpost courier duties; *T'lava*, served as Tribunal courier during Dominion War; *Vastara*, served as testbed for new *Theron*-class modifications. Also in service: *Surin*, *V'teldan*.

OPERATIONS CHARACTERISTICS

Crew/Passengers/Evac: 8/32/140 [3 pwr/round]

Computers: 2 [2 pwr/round]

Transporters: 1 personnel, 1 cargo, 1 emergency [2 pwr/round]

Tractor Beams: 1 fv [2/rating used]

PROPULSION AND POWER CHARACTERISTICS

Warp System: 6.0/8.6/9.2 (6 hours) [2/warp factor]

Impulse System: .72c/.9c [7/9 pwr/round]

Power: 100

SENSOR SYSTEMS

Long-range Sensors: +1/14 light years [6 pwr/round]

Lateral Sensors: +1/1 light year [4 pwr/round]

Navigational Sensors: +1 [5 pwr/round]

Cloak: 5 [20 pwr/round]

Sensors Skill: 3

WEAPONS SYSTEMS

Type I Disruptor

Range: 10/30,000/100,000/300,000

Arc: All (720 degrees)

Accuracy: 4/5/7/10

Damage: 15

Power: [15]

Weapons Skill: 3

DEFENSIVE SYSTEMS

Type R-ID Phased Deflector Shields

Protection: 47/72

Power: [47]



MERET-CLASS INCURSION CRUISER

Class and Type: *Meret*-class Incursion Cruiser
Commissioning Date: 2359

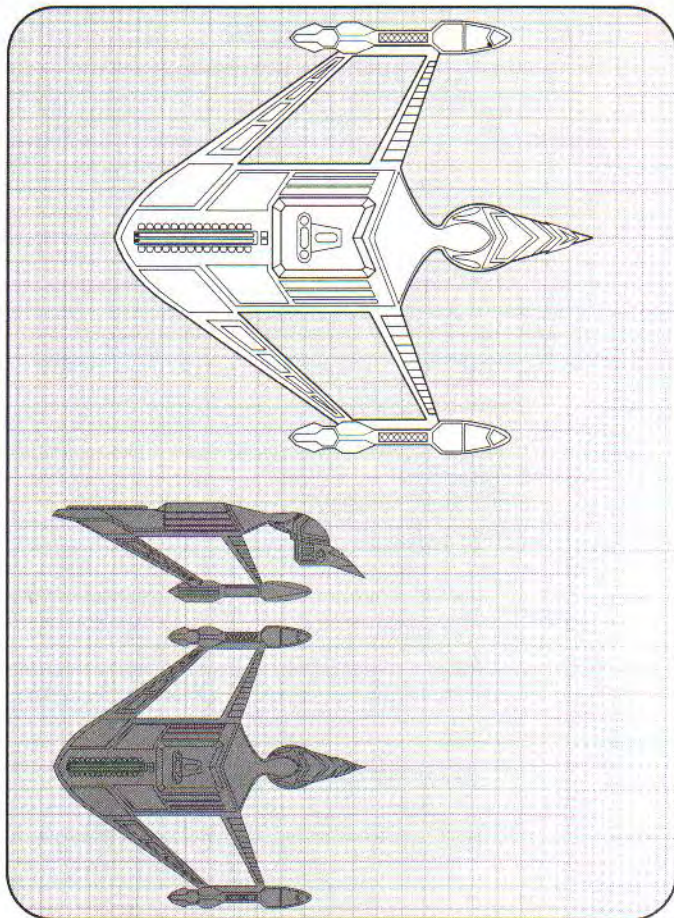

HULL CHARACTERISTICS

Size: 8 (517 meters long, 27 decks)
Resistance: 4
Structural Points: 160

DESCRIPTION AND NOTES

Fleet Data: Designed for long-range reconnaissance and search-and-destroy missions, *Meret*-class vessels have assumed important offensive roles in most fleets of the Star Navy. Utilizing an "open" wing design, this class represents a new variation on the accepted bilateral designs of the larger warbird classes. Constructed primarily to conserve additional weight and increase sublight performance, the variant profile does not seem to affect the vessel's cloaking ability adversely.

Combining an array of diverse capabilities, *Meret*-class vessels have become widely recognized within the Star Navy for their unsurpassed versatility. These ships were originally rushed into development in the wake of the Empire's renewed contact with the United Federation of Planets. As intelligence reports provided more and more insight into the Empire's spinward neighbor, the Star Navy saw the need for several new classes of incursion vessels.

Equipped with improved cloaking technology and outfitted with considerable armaments, *Meret*-class ships immediately proved themselves as exemplary patrol and harassment vessels, capable of covert border crossings and extended intelligence-gathering missions. Their improved cloaks, distinctive design, and significant defenses have made these ships a favorite of the *Tal Shiar*. In fact, a variant of the *Meret* class—designed specifically for intelligence operations and christened the *D'viret* class—remains in heavy use by the *Tal Shiar* today.

Noteworthy vessels/service records/encounters: *Meret*, prototype; *D'tervek*, disappeared while on covert mission in Klingon space; *Mederem*, participated in attempted invasion of Vulcan in 2368; *S'ten*, classified disappearance during Dominion War; *V'tallus*, lost in Battle of Eridam during Fourth Taurhai Offensive; *Vassam*, assigned to permanent outpost patrol in Empty Frontier. Also in service: *D'delean*, *Lattem*, *S'delon*.

OPERATIONS CHARACTERISTICS

Crew/Passengers/Evac: 600/2,200/5,000 [7 pwr/round]
Computers: 4 [4 pwr/round]
Transporters: 4 personnel, 4 cargo, 4 emergency [12 pwr/round]
Tractor Beams: 1 ad, 1 fd, 1 fv [2/rating used]

PROPULSION AND POWER CHARACTERISTICS

Warp System: 6.0/9.0/9.4 (6 hours) [2/warp factor]
Impulse System: .7c/.9c [7/9 pwr/round]
Power: 190

SENSOR SYSTEMS

Long-range Sensors: +2/16 light years [6 pwr/round]
Lateral Sensors: +2/1 light year [4 pwr/round]
Navigational Sensors: +2 [5 pwr/round]
Cloak: 10 [40 pwr/round]
Sensors Skill: 4

WEAPONS SYSTEMS

Type K Disruptor

Range: 10/30,000/100,000/300,000
Arc: All (720 degrees)
Accuracy: 4/5/7/10
Damage: 21
Power: [21]

Class XIV Plasma Torpedoes

Number: 200
Launchers: 1 ad, 1 fv,
Spread: 10
Arc: Forward or aft, but are self-guided
Range: 15/300,000/1,000,000/3,500,000
Accuracy: 4/5/7/10
Damage: 20
Power: [5]
Weapons Skill: 4

DEFENSIVE SYSTEMS

Type R-III Phased Deflector Shields

Protection: 60/80
Power: [60]

VERELEUS-CLASS DREADNOUGHT

Class and Type: *Vereleus*-class Dreadnought
Commissioning Date: 2371

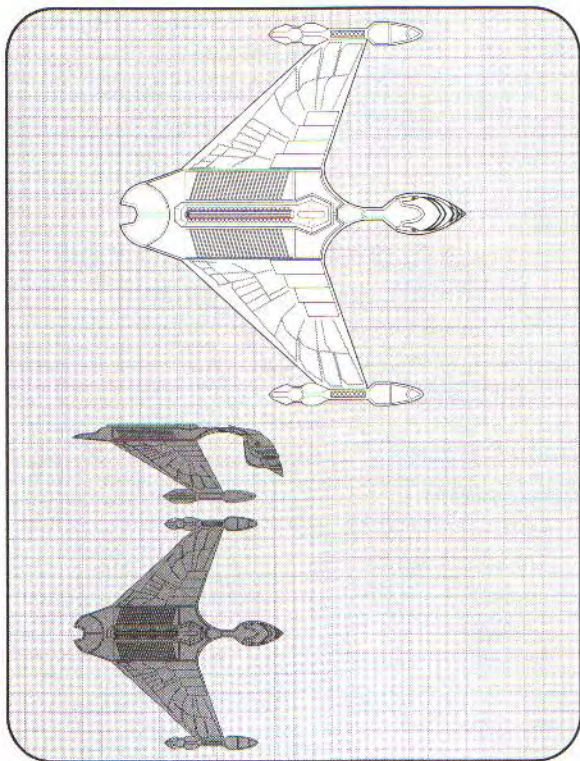

HULL CHARACTERISTICS

Size: 10 (1,350 meters long, 72 decks)
Resistance: 5
Structural Points: 200

OPERATIONS CHARACTERISTICS

Crew/Passengers: 1,850/6,400/11,000 [7 pwr/round]
Computers: 6 [6 pwr/round]
Transporters: 9 personnel, 8 cargo, 9 emergency [13 pwr/round]
Tractor Beams: 1 ad, 1 fd, 1 fv [2/rating used]

DESCRIPTION AND NOTES

Fleet Data: The *Vereleus* class represents the pinnacle of modern Romulan starship design. The largest in active production in the Star Navy, *Vereleus*-class vessels have recently entered service as flagships in most of the Navy's command fleets. Boasting expanded subspace communications and sensor packages, the *Vereleus* class was designed from the beginning to serve as a space-based, front-line command center. The addition of an additional secondary battle bridge indicates the importance accorded this ambitious new role by the Star Command.

Building on the legendary successes of the *D'deridex* class and the other heavy warbird classes, the *Vereleus* class utilizes an expanded, but less "sweeping," quantum nacelle configuration. This design not only allows its core deck sections to be much larger and deeper than those found in its predecessors, but it also protects the sophisticated sensor equipment necessary for the vessel to fulfill its intended role, all without drastically affecting its cloaking ability. While perhaps less graceful in appearance than its elegant warbird ancestors, the utility of this configuration has already proven itself in numerous engagements along every imperial border.

The *Vereleus* class also introduced the new singularity torpedo to the Star Navy's arsenal. Developed in response to Starfleet's quantum torpedo, these weapons represent significant design strides in Romulan materiel research and manufacturing. The first dreadnoughts equipped with singularity launchers were commissioned in 2373; earlier vessels are currently being upgraded with the new technology.

Noteworthy vessels/service records/encounters: *Vereleus*, prototype; *Pilaron*, assigned to Federation Neutral Zone monitoring during final weeks of Dominion War; *Sor*, lost in the Battle of Destrux during the Fifth Taurhai Offensive in 2374; *Tovarek*, recently commissioned as flagship of Tullan Fleet; *Veletan*, assigned as flagship of Fourth Spinward Fleet. Also in service: *Enem*, *Marrus*.

PROPULSION AND POWER CHARACTERISTICS

Warp System: 6.0/9.0/9.6 (6 hours) [2/warp factor]
Impulse System: .7c/.9c [7/9 pwr/round]
Power: 220

SENSOR SYSTEMS

Long-range Sensors: +2/18 light years [6 pwr/round]
Lateral Sensors: +2/2 light years [4 pwr/round]
Navigational Sensors: +2 [5 pwr/round]
Cloak: 10 [40 pwr/round]
Sensors Skill: 5

WEAPONS SYSTEMS

Type I Disruptor

Range: 10/30,000/100,000/300,000
Arc: All (720 degrees)
Accuracy: 4/5/7/10
Damage: 24
Power: [24]

Class XIV Plasma Torpedoes

Number: 330
Launchers: 1 ad, 1 av, 1 fv,
Spread: 10
Arc: Forward or aft, but are self-guided
Range: 15/300,000/1,000,000/3,500,000
Accuracy: 4/5/7/10
Damage: 20
Power: [5]

Type G-II Singularity Torpedoes

Number: 60
Launchers: 1 ad, 1 av, 1 fv
Spread: 10
Arc: Forward or aft, but are self-guided
Range: 15/300,000/1,000,000/3,500,000
Accuracy: 4/5/7/10
Damage: 24
Power: [6]
Weapons Skill: 5

DEFENSIVE SYSTEMS

Type R-IV Phased Deflector Shields

Protection: 70/90
Power: [70]

D'VIRIN-CLASS INCURSION FRIGATE

Class and Type: *D'virin*-class Incursion Frigate
Commissioning Date: 2343

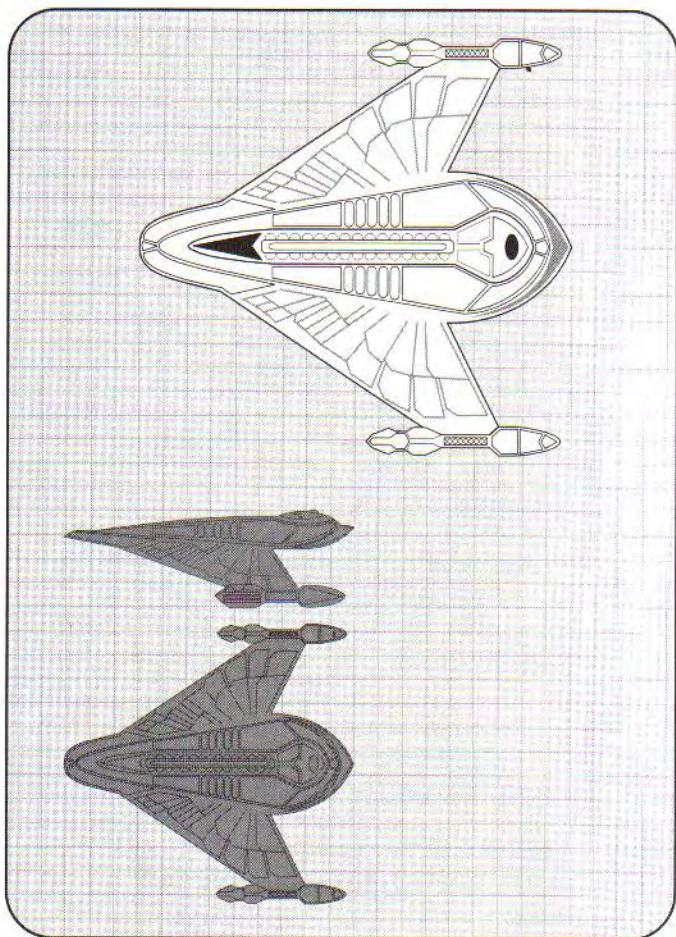

HULL CHARACTERISTICS

Size: 6 (389 meters long, 12 decks)
Resistance: 4
Structural Points: 120

DESCRIPTION AND NOTES

Fleet Data: First commissioned in the mid-24th century, the *D'virin* class of incursion frigates was designed as a direct homage to the venerable *Tellus* class of early 23rd-century warbirds. Designed as forward observation and long-range reconnaissance vessels, these small ships still manage to pack quite an offensive punch. Their quickness—combined with their deep-space capabilities—has made them fixtures at most Romulan frontier outposts.

Like their slightly larger counterparts—the *D'tavan* class of strike frigates—*D'virin*-class vessels are capable of a diverse range of mission profiles. Historically, these ships have been stationed in newly occupied client systems within the Empire, or along hostile borders with neighboring stellar powers. Their high sustainable velocities, coupled with their ability to remain cloaked for long periods of time, make them ideal covert penetration vessels.

Unfortunately, these capabilities also require large portions of the vessel to be dedicated to the enhanced systems, making the *D'virin* class perhaps the least comfortable of all Romulan ship types. Of course, in true Romulan fashion, the crews of these vessels take a perverse pride in their hardship; members of this extended "*D'virin* fraternity" often greet each other like long-lost brothers, allowing their common experiences to create an unspoken bond among them.

Noteworthy vessels/service records/encounters: *D'virin*, prototype; *Marilon*, participated in attempted invasion of Vulcan in 2368; *S'tar*, destroyed by Borg while on patrol in Diodor Sector; *S'var*, destroyed during blockade of Serus III in 2361; *V'nitor*, lost in the Tullan Reach in 2355; *Xi*, engaged a Klingon expeditionary force along border in 2367. Also in service: *D'relix*, *V'mendin*, *Vathos*.

OPERATIONS CHARACTERISTICS

Crew/Passengers/Evac: 200/300/600 [5 pwr/round]
Computers: 4 [4 pwr/round]
Transporters: 4 personnel, 3 cargo, 3 emergency [5 pwr/round]
Tractor Beams: 1 ad, 1 fd, 1 fv [2/rating used]

PROPULSION AND POWER CHARACTERISTICS

Warp System: 5.6/9.0/9.2 (12 hours) [2/warp factor]
Impulse System: .7c/.9c [7/9 pwr/round]
Power: 175

SENSOR SYSTEMS

Long-range Sensors: +2/14 light years [6 pwr/round]
Lateral Sensors: +2/1 light year [4 pwr/round]
Navigational Sensors: +1 [5 pwr/round]
Cloak: 8 [32 pwr/round]
Sensors Skill: 4

WEAPONS SYSTEMS

Type J Disruptor

Range: 10/30,000/100,000/300,000
Arc: All (720 degrees)
Accuracy: 4/5/7/10
Damage: 18
Power: [18]

Class XIV Plasma Torpedoes

Number: 160
Launchers: 1 ad, 1 fv
Spread: 10
Arc: Forward or aft, but are self-guided
Range: 15/300,000/1,000,000/3,500,000
Accuracy: 4/5/7/10
Damage: 20
Power: [5]
Weapons Skill: 4

DEFENSIVE SYSTEMS

Type R-II Phased Deflector Shields

Protection: 55/75
Power: [55]

DERESUS-CLASS HEAVY SCOUT

Class and Type: *Deresus*-class Heavy Scout
Commissioning Date: 2321

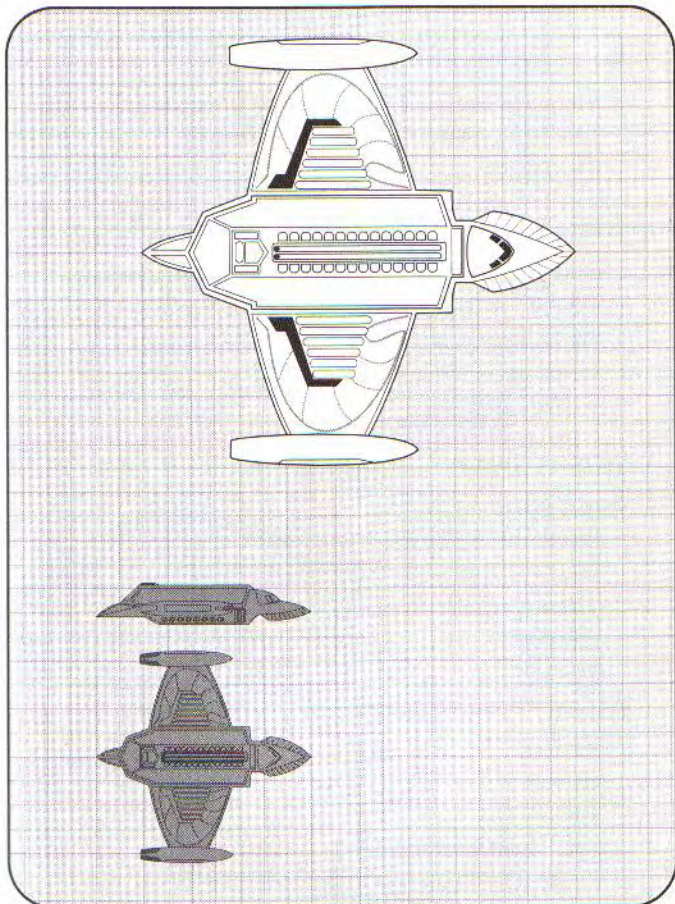

HULL CHARACTERISTICS

Size: 4 (217 meters long, 5 decks)
Resistance: 3
Structural Points: 80

DESCRIPTION AND NOTES

Fleet Data: Utilizing a spaceframe descended in part from older 23rd-century cruiser designs, *Deresus*-class scouts have served as fleet workhorses for years. Their compact profiles remain familiar sights along every Imperial frontier, and fifty years of active service has solidified the class' reputation as one of the foremost exploratory vessels in the Star Navy.

First launched in 2321, *Deresus*-class ships were originally intended to replace the venerable *T'varak* class of near-space scouts. While the new *Deresus* class accomplished this goal, its long-range capabilities surprised even its designers. Small, versatile, and capable of extended mission profiles, many *Deresus*-class vessels were subsequently outfitted for long-range survey and observation duties.

As a result of the infamous Praetorian Edict of 2348 (known outside the Empire as the Expansion Directive), the Exploration Command initiated an extensive quantum drive upgrade program, with the *Deresus* class always at the vanguard of the new developments and refits. Coreward and spinward expansion reached a fevered level in the wake of these experiments, and hundreds of the upgraded *Deresus*- and *Nir'at*-class (a slightly larger version of the *Deresus* class) vessels were commissioned during the early 2350's. This expansionist period saw the establishment of numerous outposts along the Empire's coreward borders, as well as colonization and occupation efforts throughout vast reaches of the Empty Frontier.

Noteworthy vessels/service records/encounters: *Deresus*, prototype; *Averek*, disappeared exploring the Empty Frontier in 2359; *D'jarek*, used as test vessel for quantum singularity drive upgrade experiments in 2350; *Suretak*, lost at the vanguard of the Third Taurhai Offensive in 2365; *T'varian*, participated in attempted invasion of Vulcan in 2368; *Torelan*, assigned to Rimward Exploratory Wing in late 2360's. Also in service: *V'tirex*, *Vurin*.

OPERATIONS CHARACTERISTICS

Crew/Passengers/Evac: 45/150/350 [5 pwr/round]
Computers: 3 [3 pwr/round]
Transporters: 2 personnel, 2 cargo, 2 emergency [3 pwr/round]
Tractor Beams: 1 ad, 1 fv [2/rating used]

PROPULSION AND POWER CHARACTERISTICS

Warp System: 5.0/8.5/9.1 (8 hours) [2/warp factor]
Impulse System: .7c/.9c [7/9 pwr/round]
Power: 125

SENSOR SYSTEMS

Long-range Sensors: +2/17 light years [6 pwr/round]
Lateral Sensors: +2/1 light year [4 pwr/round]
Navigational Sensors: +2 [5 pwr/round]
Cloak: 8 [32 pwr/round]
Sensors Skill: 4

WEAPONS SYSTEMS

Type I Disruptor

Range: 10/30,000/100,000/300,000
Arc: All (720 degrees)
Accuracy: 5/6/8/11
Damage: 15
Power: [15]

Class XI Plasma Torpedoes

Number: 75
Launchers: 1 ad, 1 fv
Spread: 4
Arc: Forward or aft, but are self-guided
Range: 15/300,000/1,000,000/3,500,000
Accuracy: 4/5/7/10
Damage: 20
Power: [5]
Weapons Skill: 4

DEFENSIVE SYSTEMS

Type R-IC Phased Deflector Shields

Protection: 45/70
Power: [45]



T'RASUS-CLASS LIGHT STARBIRD

Class and Type: *T'rasus*-class Starbird (Exploratory Cruiser)

Commissioning Date: 2357

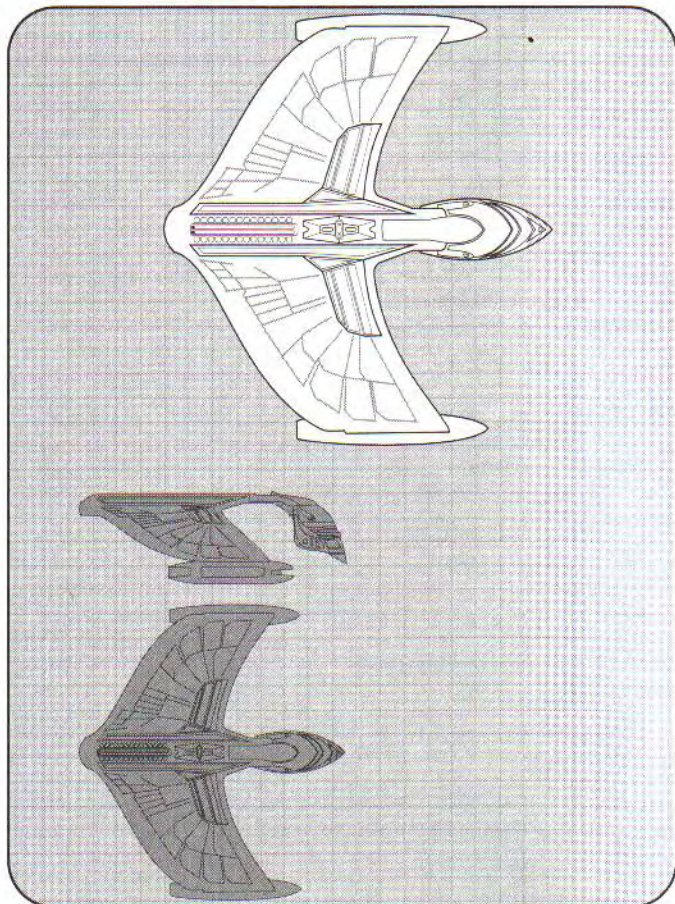

HULL CHARACTERISTICS

Size: 6 (407 meters long, 19 decks)

Resistance: 4

Structural Points: 120

DESCRIPTION AND NOTES

Fleet Data: First commissioned in the wake of the Praetorian Edict of 2348, these ships were the first of the new "Starbird" classes of exploration vessels. Utilizing specifications created for the quantum upgrade projects of the mid-2350's, the *T'rasus* class of exploratory cruiser was designed for extended deep-space exploration, survey, and contact missions. Its success as a class was largely responsible for the increasing respect accorded the Exploration Command in the late 24th century.

Prior to the development of the *T'rasus* class and its sister classes, most Romulan vessel designs were predicated on military needs and specifications. The advent of the Starbird classes marked a new wave of specialized planning and design for the Star Navy, a movement that has continued to gather speed and support into the present day. The success of the expansionist edicts of the 2350's would pave the way for the Exploration Edicts of the 2360's and '70's, and the newer exploratory classes would continue to be at the forefront of such programs.

Although the *T'rasus* class was designed as an exploratory vessel, its versatility has lent itself to several variant designs during the tense threat climate of the 2370's. These military variants were capable of making the long journey into the Alpha Quadrant during the conflict with the Dominion, and most served with distinction alongside many of the larger warbird and warship classes.

Noteworthy vessels/service records/encounters: *T'rasus*, prototype; *D'kalam*, disappeared exploring the Starry Road Nebula in 2360; *D'tharan*, lost during rimward expansion sorties in late 2360's; *Durelan*, lost while engaging in reconnaissance during Fifth Taurhai Offensive; *T'Laratex*, currently engaged in deep space exploration beyond the Empty Frontier; *T'xeren*, believed destroyed by Borg in Tullan Reach. Also in service: *D'stelen*, *Visen*.

OPERATIONS CHARACTERISTICS

Crew/Passengers/Evac: 300/400/800 [7 pwr/round]

Computers: 4 [4 pwr/round]

Transporters: 4 personnel, 4 cargo, 4 emergency [12 pwr/round]

Tractor Beams: 1 ad, 1 fd, 1 fv [2/rating used]

PROPULSION AND POWER CHARACTERISTICS

Warp System: 5.6/8.4/9.2 (8 hours) [2/warp factor]

Impulse System: .65c/.85c [6/8 pwr/round]

Power: 180

SENSOR SYSTEMS

Long-range Sensors: +2/14 light years [6 pwr/round]

Lateral Sensors: +2/1 light year [4 pwr/round]

Navigational Sensors: +2 [5 pwr/round]

Cloak: 10 [40 pwr/round]

Sensors Skill: 4

WEAPONS SYSTEMS

Type K Disruptor

Range: 10/30,000/100,000/300,000

Arc: All (720 degrees)

Accuracy: 4/5/7/10

Damage: 21

Power: [21]

Class XIV Plasma Torpedoes

Number: 200

Launchers: 1 ad, 1 fv,

Spread: 10

Arc: Forward or aft, but are self-guided

Range: 15/300,000/1,000,000/3,500,000

Accuracy: 4/5/7/10

Damage: 20

Power: [5]

Weapons Skill: 4

DEFENSIVE SYSTEMS

Type R-III Phased Deflector Shields

Protection: 60/80

Power: [60]

D'DERIDEX-CLASS HEAVY WARBIRO

Class and Type: *D'deridex*-class Heavy Warbird
Commissioning Date: 2349

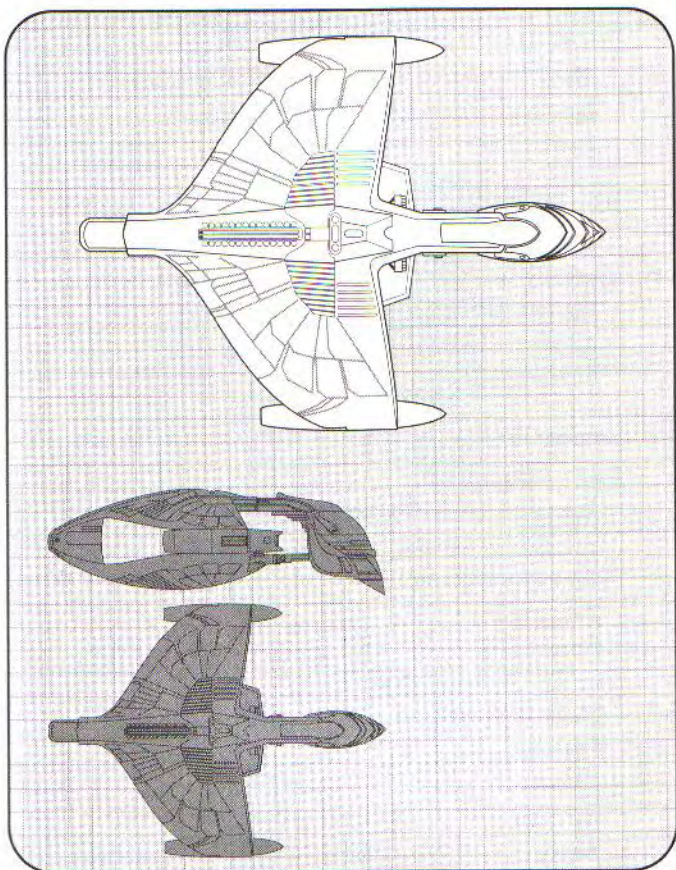

HULL CHARACTERISTICS

Size: 10 (1,260 meters long, 83 decks)
Resistance: 4
Structural Points: 200

DESCRIPTION AND NOTES

Fleet Data: Forming the core of the 24th-century Star Navy's fleets, *D'deridex*-class warbirds have become common sights throughout the Empire, from the frontier to the Imperial core. Descended from the legendary *Argus*-class warships of the late 23rd century, the *D'deridex* class refined and improved on almost all of its predecessor's most critical design elements. It was these refinements, and their proven utility during threat situations, that made these warbirds the pinnacle of mid-24th-century Romulan vessel design.

Many of the class' systems are designed for optimum efficiency, allowing these vessels to divert additional power to their improved cloaking systems, which require immense allocations. Utilizing bilateral navigation and deep-space sensor configurations, as well as an overall bilateral hull design, the *D'deridex* class represents the most efficient and effective cloaking profile ever developed. Although many of its original duties have been transferred to a number of the more specialized warbird designs in recent years, the *D'deridex* class remains the bulwark of the Romulan fleet.

As the keystone of the Romulan fleet, *D'deridex*-class vessels are constructed in large numbers at every major Naval shipyard and spacedock. *D'deridex*-class ships continue to serve with distinction in every command and senatorial fleet, and in fact the Praetor's own flagship has traditionally been a member of this class since its inception. With a fleetwide class refit scheduled for 2378, *D'deridex*-class vessels should remain a familiar presence throughout the Star Empire well into the next century.

Noteworthy vessels/service records/encounters: *D'deridex*, prototype; *D'dereq*, lost during routine patrol along Federation border; *D'seret*, participated in the Duras Treason in early 2368; *D'vairin*, assigned to Federation Neutral Zone patrol; *T'deret*, legendary wingship in the third Tullan Fleet; *T'dir*, destroyed by the Borg while defending Outpost 47; *T'salvan*, lost in the Dominion War; *Tarlon*, wingship of the Imperial Response Fleet, Diodor Sector. Also in service: *D'dara*, *D'taret*, *Dividices*.

OPERATIONS CHARACTERISTICS

Crew/Passengers/Evac: 1,700/6,200/10,500 [7 pwr/round]
Computers: 4 [4 pwr/round]
Transporters: 8 personnel, 8 cargo, 8 emergency [12 pwr/round]
Tractor Beams: 1 ad, 1 fd, 1 fv [2/rating used]

PROPULSION AND POWER CHARACTERISTICS

Warp System: 5.0/8.2/9.2 (6 hours) [2/warp factor]
Impulse System: .6c/.85c [6/8 pwr/round]
Power: 210

SENSOR SYSTEMS

Long-range Sensors: +2/14 light years [6 pwr/round]
Lateral Sensors: +2/1 light year [4 pwr/round]
Navigational Sensors: +2 [5 pwr/round]
Cloak: 10 [40 pwr/round]
Sensors Skill: 5

WEAPONS SYSTEMS

Type L Disruptor

Range: 10/30,000/100,000/300,000
Arc: All (720 degrees)
Accuracy: 4/5/7/10
Damage: 24
Power: [24]

Class XIV Plasma Torpedoes

Number: 300
Launchers: 1 ad, 1 fv
Spread: 10
Arc: Forward or aft, but are self-guided
Range: 15/300,000/1,000,000/3,500,000
Accuracy: 4/5/7/10
Damage: 20
Power: [5]
Weapons Skill: 5

DEFENSIVE SYSTEMS

Type R-IV Phased Deflector Shields

Protection: 70/90
Power: [70]



D'VALEK-CLASS SWIFT WARBIIRD

Class and Type: *D'valek*-class Swift Warbird
Commissioning Date: 2368

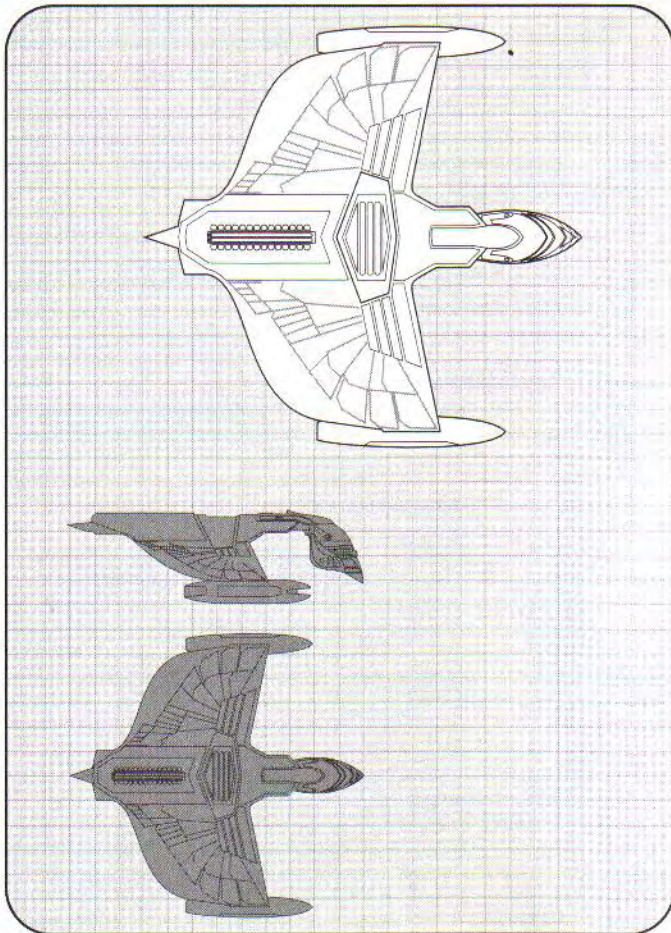

HULL CHARACTERISTICS

Size: 9 (822 meters long, 67 decks)
Resistance: 4
Structural Points: 180

DESCRIPTION AND NOTES

Fleet Data: Designed in response to the introduction of the various "fast" vessel classes recently incorporated into the Federation Starfleet, the *D'valek* class of swift warbirds represents a departure from conventional Romulan design thinking. While most warbird configurations sacrifice some degree of speed and maneuverability for greater offensive and defensive capability, the *D'valek* class does the opposite. For their considerable size, this class remains one of the fastest in the fleet.

Originally intended to serve as heavily armed, long-range support vessels for the aborted *S'varen*-class strike carriers, their role has gradually evolved to focus on rapid response and perimeter defense missions. *D'valek*-class vessels—along with their smaller cousins, the *T'varo* class of swift warbirds—form the nucleus of most of the Core Defense fleets, rapid-response units assigned to systems and outposts throughout the Imperial core worlds. These standing defense units must be ready for dispatch at a moment's notice to regions of heightened threat activity within the Empire's borders.

Much like similar Starfleet designs, *D'valek*-class vessels represent prime examples of specialized and mission-specific vessel design, a trend that shows no signs of abating. While *D'deridex*-class warbirds remain formidable jacks-of-all-trades, their warbird descendants—including both the *D'valek* and *T'varo* classes—have largely been designed according to much narrower specifications.

Noteworthy vessels/service records/encounters: *D'valek*, prototype; *Cestron*, served as wingship in Fifth Taurhai Offensive; *D'daen*, destroyed by Dominion forces in 2375; *Imparatex*, lost during routine patrol along Klingon border in 2370; *Kormorex*, led reserve forces in Battle of Delta Corescus; *S'varan*, assigned to patrol duty along Federation Neutral Zone. Also in service: *D'ressa*, *S'tel*.

OPERATIONS CHARACTERISTICS

Crew/Passengers/Evac: 1,450/5,500/10,000 [7 pwr/round]
Computers: 5 [5 pwr/round]
Transporters: 8 personnel, 7 cargo, 7 emergency [11 pwr/round]
Tractor Beams: 1 ad, 1 fd, 1 fv [2/rating used]

PROPULSION AND POWER CHARACTERISTICS

Warp System: 6.0/9.2/9.6 (6 hours) [2/warp factor]
Impulse System: .7c/.9c [7/9 pwr/round]
Power: 200

SENSOR SYSTEMS

Long-range Sensors: +2/14 light years [6 pwr/round]
Lateral Sensors: +2/1 light year [4 pwr/round]
Navigational Sensors: +2 [5 pwr/round]
Cloak: 9 [36 pwr/round]
Sensors Skill: 5

WEAPONS SYSTEMS

Type I Disruptor

Range: 10/30,000/100,000/300,000
Arc: All (720 degrees)
Accuracy: 4/5/7/10
Damage: 24
Power: [24]

Class XIV Plasma Torpedoes

Number: 250
Launchers: 1 ad, 1 fv
Spread: 10
Arc: Forward or aft, but are self-guided
Range: 15/300,000/1,000,000/3,500,000
Accuracy: 4/5/7/10
Damage: 20
Power: [5]
Weapons Skill: 5

DEFENSIVE SYSTEMS

Type R-IV Phased Deflector Shields

Protection: 70/90
Power: [70]

THE ROMULAN DOMAIN

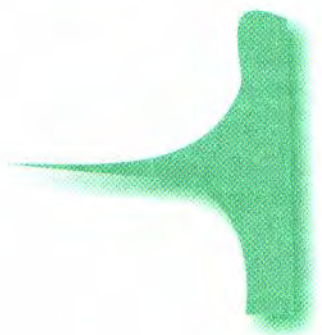

The Romulan Empire covers a vast area of space. It would take volumes to describe every sector and province of Romulan territory. This section provides a sampling of various sectors of Romulan space where the Narrator can set different adventures and stories.

Diodor Sector

Diodor Sector is located in the Beta Quadrant, on the distant fringes of the Romulan Empire, toward the Delta Quadrant. It is a coreward sector with a high concentration of stars and planets.

IMPERIAL POLITICAL ROLE

Currently, Diodor Sector has no involvement in Romulan politics. Discoveries made within the sector may affect Romulan politics, however, and the Senate will certainly take interest in some of them (see "Unusual Phenomena" below).

DOMINANT RACES/CULTURES

No one race dominates the sector, although some planets are inhabited. Most of the worlds in the sector are fairly primitive, lacking warp-drive capabilities and other advanced technology, although at least one civilization has some very powerful allies. There are signs of Borg incursion on some worlds in the sector, something of considerable interest to the Romulans.

STAR SYSTEMS

Fourteen systems lie within the bounds of Diodor Sector. Three of these systems have inhabited planets, while a fourth contains the ruins of a planetary civilization assimilated by the Borg. Three other systems supported Romulan colonies until the arrival of the Borg. The remaining systems have no intelligent life, although several contain considerable mineral resources and interesting geoplanetary phenomena worthy of study. Several contain jovian worlds suitable for refueling operations.

UNUSUAL PHENOMENA

The Diodor Sector is bordered on the side closest to the Delta Quadrant by an expansive nebula, the remains of a star that went supernova millions of years ago. The inhabitants of Alba and Langus call the nebula the Starry Road, and associate it with their myths and legends. In fact, the Starry Road was once the home star of the system inhabited by beings the Langians call the Azar, before they evolved to exist outside of normal space-time. The Azar imply that their home sun going supernova was part of what drove their ancestors to seek an escape into subspace.

The presence of the Azar in the Diodor Sector causes many subspace anomalies, which in turn cause severe communications problems throughout the region. Currently the Romulans attribute these anomalies to intermittent radio emissions from the nebula, but investigating them is part of the mission of Romulan ships assigned to explore the sector. The anomalies can cause random systems failures and communication and sensor black-outs, in addition to interfering with a vessel's singularity or warp drive and cloaking systems.

HISTORY

Millions of years ago, the Diodor system was home to a lifeform known as the Azar. They developed a highly advanced technological civilization capable of tremendous feats of solar engineering, terraforming, and genetic manipulation. The Azar advanced themselves quickly along the evolutionary ladder, and engineered parts of Diodor Sector to suit their needs. They seeded several worlds within the sector with protogenetic material as part of their terraforming efforts.

Unfortunately, some of the Azar's early solar engineering experiments on their home star caused it to destabilize and go supernova. Despite all their efforts, the Azar were unable to prevent the destruction of their home star system. With their terraforming efforts incomplete and destruction rapidly approaching, the Azar discovered a means of displacing a portion of their population into subspace as a means of survival. They did so as the supernova destroyed the remainder of Azar civilization.

The Azar who survived in subspace were radically altered by their new existence. They became multidimensional beings with considerable control over subspace phenomena, essentially subspace beings, like living warp fields. They could travel at warp speeds through space and create spatial distortion fields to suit their needs. With their own civilization destroyed, they took it upon themselves to watch over and care for the worlds they had begun to terraform. The Azar are known in the myths and legends of the species on those worlds as gods or spirits with magical powers.

In 2349, the Romulan Empire began exploring Diodor Sector. The Romulans planted several colonies on Class M worlds within the sector and Romulan ships continued to chart and study the region. A Romulan vessel made contact with Langus ten years ago, but the ship and its crew were destroyed by a subspace anomaly created by the Azar. The Romulan Star Command originally assumed navigation hazards near the nebula caused the loss of the ship, and later placed the blame for its destruction on the Borg.

In 2367, a Borg cube entered Diodor Sector. The Borg attacked and assimilated the Romulan colony worlds. It then moved on to Prosenna, a world seeded by the Azar, and assimilated it. When the Azar discovered the Borg incursion, they created a powerful spatial distortion that completely destroyed the Borg ship. The Borg Collective assumed Diodor Sector was too dangerous for assimilation and shifted its attention elsewhere. Since that time, the Azar have been especially alert for intruders in their space and react with hostility toward anyone who attempts to interfere with their "children." The Romulan Senate has ordered a thorough exploration of the Diodor Sector for additional information about the Borg and their incursions into Romulan space.

IMPORTANT WORLDS

Three systems in Diodor Sector have inhabited worlds, two of which are home to humanoid lifeforms seeded there by the Azar. Genetic and biological analysis of the inhabitants will reveal genetic similarities too great to have occurred naturally, indicating some sort of ancient genetic manipulation. The third system contains lifeforms which evolved there naturally, and which are not under the protection of the Azar.

The Langus system contains two inhabited worlds, Langus and Alba. The Langians are humanoids with primitive interplanetary travel, which they used to colonize Alba. They are tall and have vaguely feline features, including eyes with slitted pupils, tawny skin, and long, manelike hair. They are fierce and warlike, often fighting small planetary wars with each other. Currently, the Alba colony agitates for independence from Langus, which the homeworld refuses to give. Langian legends are full of stories about the Azar, who they believe are "sky spirits."

The Ennar system is home to the Ennarians, a species almost genetically identical to the Langians and at the same level of technological development. Unlike their cousins, the Ennarians are quite peaceful and have a society based on the cultivation of the intellect. Ennarian civilization has been shaken recently by direct contact with the Azar, in which certain Ennarians were taken from their homeworld and transported to Langus or Alba. Once there, they were allowed to explore for a time, then returned home.

These "exploration missions" take place at regular intervals, several times each year. The Ennarians remain uncertain why the Azar convey Ennarian explorers. They believe the Azar intend them eventually to bring a message of peace to the Langians. (The Azar indeed hope the more "successful" Ennarians can assist the Langians and strengthen both civilizations.)

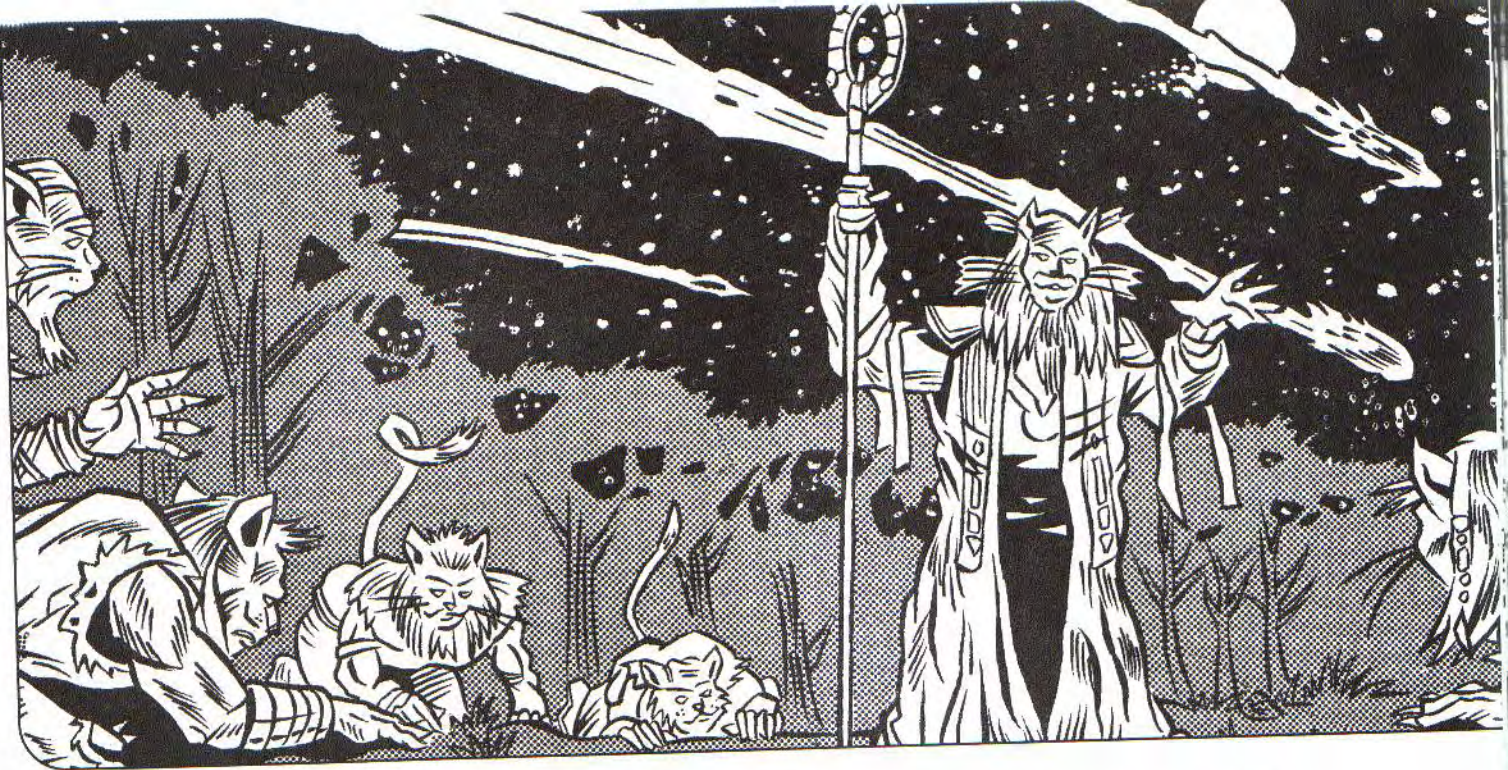

While the Azar themselves intervene in affairs in Diodor Sector, they prefer to keep other species from interfering with Langus or Ennar. Ships attempting such interference suffer from system failures and may find themselves displaced dozens or even hundreds of light years away by a sudden, inexplicable, spatial anomaly.

The Krotar System is home to the Krotarians, reptilian humanoids similar in many respects to the Gorn (although Diodor Sector is quite far from Gorn space). The Krotarians are a peaceful species on the verge of developing warp travel. They have small colonies within their own star system, but Krotar is their only Class M world. The Krotarian warp-drive program has been plagued with difficulties related to the subspace anomalies in the sector. Their research has brought the Krotarians close to discovering the existence of the Azar.

Another planet in the sector, called Prosenna, was once home to a race very similar to the Langians and the Ennarians. The Borg assimilated this civilization. Only great gouges and rents in the planet's surface remain as evidence of a thriving civilization on Prosenna. When the Azar destroyed the Borg Cube, some of its remains crashed on this planet. The recovery of the wreckage could yield valuable information about the Borg. It could also reactivate some components and transmit a message to the Borg Collective, however, bringing more Borg to investigate.

Three Romulan colony worlds—Gotanna III, Felussus, and Sandal IV—lie within Diodor Sector. All of these worlds were attacked and assimilated by the Borg. All the machine elements from the planet were removed, along with the inhabitants. The Romulan Senate will consider proposals to resettle these worlds, once it has been determined the sector is once again safe for colonization.

Jubel Sector

Jubel Sector is located toward the antispinward side of the central Romulan Empire. It is one of the older sectors of the Empire, first colonized centuries ago, and home to many prosperous and successful colonies. The sector has gained a considerable reputation as a hotbed of Imperial intrigue.

IMPERIAL POLITICAL ROLE

Jubel Sector is currently caught in a conflict between its two most powerful senators, representatives in an old family feud that stretches back to the founding of Romulus. Crassian D'mora is a member of the Nej'ahar Coalition of the Senate. His rival, Ferran Solos, is a member of the Jol Tan Coalition and a strong supporter of the *Tal Shiar*. The allies and forces of the two senators play out this conflict on the floor of the Senate as well as among the systems of Jubel Sector.

DOMINANT RACES/CULTURES

The Jubel System is strongly dominated by the Romulans. It has been a part of the Romulan Empire since the earliest days of Romulan interstellar exploration and colonization. Although some Romulan client species live on colonies and worlds within the sector, its culture and heritage is distinctly Romulan.

STAR SYSTEMS

Jubel Sector contains nine systems, four of them inhabited by a total of more than four billion Romulans.

HISTORY

Jubel sector was settled in the 590's, in the first wave of Romulan expansion out from their home system. The Romulan pioneers discovered several habitable worlds within the system, along with others capable of being terraformed to suit the Romulans' needs. The colonists who claimed worlds in Jubel Sector can trace their ancestry back to some of the prominent families of Romulus, those who chose to leave the homeworld and follow the path of *D'era* with all their hearts. Many of them did not come to prominence until the colonies became more successful, their goods in demand within the Empire and their senators gaining greater influence within the Romulan Senate.

Recently, an old feud gained new life when the ambitious Solos, Senator of Quatel, decided to consolidate his power and that of his coalition in Jubel Sector by

QUATELLIANS

Attributes

Fitness 2 [5]

Vitality +1

Coordination 2 [4]

Intellect 2 [5]

Presence 2 [5]

Willpower -1

Psi 0 [5]

Skills

Craft (choose Specialization) 2 (3)

Culture (Quatellian and Romulan) 2 (3) and (3)

History (Quatellian) 1 (2)

Language

Quatel 2

Romulan 1

Repair (choose Specialization) 1 (2)

World Knowledge (Quatel) 1 (2)

Typical Traits

Engineering Aptitude +3

weakening the position of his closest rival, Senator D'mora of Justarus. D'mora is a staunch conservative and supports initiatives which strengthen the Empire, but he opposes rampant outward expansion, preferring to see the Empire carefully manage its conquered territories to ensure a smooth and steady progression along the path of *D'era*. Solos is more aggressive, favoring both military conquest and an iron hand in keeping planetary populations under control. He believes firmly that loyalty to the Empire is paramount and that all those who question the Empire or its destiny are suspect. This has led Solos into the camp of the Jol Tan Coalition and the *Tal Shiar*, who consider him a useful ally.

D'mora is opposed to the *Tal Shiar*. He believes the loyalty of a true Romulan cannot be questioned, and the *Tal Shiar* spend far too much of their time causing trouble for honest citizens of the Empire, when they should be turning their attention more to outside threats like the Borg, the Taurhai, the Klingons, and the Federation. D'mora wants to see the Senate allocate resources to the needs of the Romulan people and to the needs of the military, rather than "squandering" them on additional programs and operatives for the already too-powerful *Tal Shiar*.

The *Tal Shiar* covertly supports Solos' desire to displace D'mora, and a localized war has broken out between the two senators. Calling upon their military contacts, both men hatch plots and counterplots against each other. Solos' agents and *Tal Shiar* allies try to frame D'mora and make him look like a traitor. Ships loyal to D'mora destroy shipping convoys leaving Quatel, laying the blame on "pirates" or "terrorists." Romulan soldiers loyal to Solos attempted to assassinate D'mora using a stolen Federation runabout equipped with a cloaking device, hoping the blame would fall on the Federation. Agents of D'mora have tried to stir up rebellion among the native inhabitants of Quatel.

The *Tal Shiar* keeps the Romulan Senate largely ignorant of the scope of the conflict, although the feud is well known. Solos presently plots to supply a faction of the Romulan underground with intelligence and supplies to get them to assassinate D'mora. For his part, D'mora wants to expose the *Tal Shiar's* involvement in the affair so they will be forced to withdraw their support from Solos in order to avoid censure by the Senate.

IMPORTANT WORLDS

The four Romulan colony worlds are Justarus, Quatel, Hybera, and Ustullan. Justarus is represented by Senator D'mora, while Senator Solos represents Quatel. The senator from Hybera has allied himself with D'mora, while the newly appointed senator from Ustullan is allied with Solos. D'mora believes Solos and the *Tal Shiar* have something to do with the unfortunate death of Ustullan's previous senator in a shuttle accident while returning from Romulus, but he has no proof.

Justarus is a temperate Class M world with a Romulan population of about 1.5 billion. It is an ocean-covered world, home to bustling cities built in the classic Romulan style. The planet has a strong aquaculture industry and a very active intellectual life, which Senator D'mora strongly supports, attending performances at major theaters, going to art unveilings, and speaking at the dedication of the new university on the planet. Life on Justarus is cosmopolitan and largely driven by trends from Romulus and Remus.

Quatel is a world the Romulans conquered centuries ago. The native inhabitants, the Quatellians, are a humanoid species thoroughly integrated into the Empire. When the Romulans first arrived, the Quatellians were a primitive species, barely out of their own Bronze Age. The Romulans took control of the planet and established a colony there, while putting the Quatellians to work in Romulan homes and factories. The Quatellian population still outnumbers the Romulans, but there are no concerns about security.

The Quatellians are a peaceful people who seem content with their lot as clients of the Romulan Star Empire. They work as domestic help in the homes of prominent Romulans and in factories producing various goods shipped across the Empire. Quatellian gemstones and jewelry are considered some of the finest in the Empire and are currently much in demand, particularly on the homeworlds.

Othan Sector

The Othan Sector is located near the Romulan/Klingon border in the Beta Quadrant. It is a "buffer sector" between the two interstellar powers, serving much the same function as the Federation Neutral Zone does along the empire's frontier further to coreward.

IMPERIAL POLITICAL ROLE

The Romulan Empire is in the process of "pacifying" (read: conquering) the Othan Sector as part of an ongoing policy of creating a strong defense along the Klingon border and trying to provoke the Klingon Empire into outright confrontation in order to test its strength. The Othan Campaign has strong support in the Romulan Senate, and many in the military see it as another opportunity to win greater glory in the name of the Empire.

DOMINANT RACES/CULTURES

The Othan Empire, a small interstellar power that has colonized most of the sector, dominates the Othan Sector. The Othans are a humanoid proto-Klingon race, with similar physiology and warlike attitudes. Othans have pale skin and light brown, blond, or white hair, which is usually worn long. Male Othans have full beards. Othans tend to be shorter than Klingons, with a heavier build and more fatty tissue due to the cold environment of their home world.

Romulan scientists speculate that the Othans might be an offshoot of an ancient Klingon colony or from Klingon stock transplanted to Othan by the Hur'q or another alien race in the distant past. Although formidable hand-to-hand combatants, Othan technology is generally inferior to that of the Romulans, so they are outclassed in space battles with the Romulan fleet.

STAR SYSTEMS

The Othan Sector contains eight star systems, five of which are inhabited by Othans and their colonies. The other three contain only lifeless Class D and F worlds, which host small mining colonies but little else.

HISTORY

The Othans achieved interplanetary space flight approximately one hundred fifty years ago and began exploring their own solar system. They traded with early Klingon explorers for warp-drive technology and were briefly conquered by the Klingon Empire. The Klingons withdrew from Otha in the 2290's when their alliance with the Romulans collapsed, forming a buffer zone of systems between the two empires. Since that time, the Othans have colonized several nearby systems, building a small interstellar empire similar in some ways to the Klingon Empire. They refuse to join the Klingon Empire, and the Klingons haven't considered it worth the effort to conquer the Othans.

Recently, the Romulans have taken an increased interest in activity along the Klingon border and turned their attention toward the budding Othan Empire. The Romulan Star Navy was assigned to bring the Othans under the protection of the Romulan Empire, to eliminate the possibility of a renewed relationship between the Othans and the Klingons, which would place Klingon forces uncomfortably close to Romulan space. The Othans refused to join the Romulan Empire, so the Senate immediately declared the sector under Romulan control and branded the Othans as outlaws. The Navy has orders to suppress any insurrection in the sector and to bring it under the control of the Empire.

Although they are outmatched in terms of technology, the Othans continue to fight fiercely against Romulan incursion. The Senate has limited the amount of military resources that can be devoted to the taking of

OTHANS

Attributes

Fitness 3 [6]
Strength +1
Vitality +1
Coordination 3 [5]
Intellect 2 [6]
Logic -2
Presence 2 [6]
Empathy -2
Psi 0 [6]

Skills

Culture (Othan) 2 (3)
History (Othan) 1 (2)
Language
Othan 2
Primitive Weaponry (choose Specialization) 2 (3)
Unarmed Combat (choose Specialization) 2 (3)
World Knowledge (Otha) 1 (2)

Typical Traits

Bloodlust -2
High Pain Threshold +2
Toughness +2

a single sector, so Romulan field commanders must deal with logistical problems and occasional shortages of supplies and personnel, giving the Othans time to regroup and reinforce their position.

The battle between the Romulans and the Othans has not gone unnoticed by the Klingon High Council. Although the Council has decided it is wiser to avoid becoming entangled in another war with the Romulans at this time, it prefers to see an independent Othan Empire as a buffer state between them and the Romulans. Klingon agents have been dispatched to the Othan Sector, often surgically disguised as Othans, to provide covert assistance against the Romulan fleet. For their part, Romulan commanders are aware the Klingons smuggle advanced weapons and supplies to the Othans and that Klingon agents may provide them with tactical information. The *Tal Shiar* has recently begun a counterespionage campaign to root out these Klingon agents and, they hope, trigger an incident that could embarrass the Klingons and reflect poorly on the Federation/Klingon Alliance.

IMPORTANT WORLDS

Otha-Prime is the homeworld of the Othans, located near the center of the sector and protected by the outer systems. The Otha system is heavily guarded by ships and planetary orbital defense systems.

Otha-Prime is a cold, rocky planet, regularly whipped by winter storms and constantly covered in a layer of snow in all but its most tropical regions. Its native lifeforms tend to be large, lumbering herbivores and the swift, powerful carnivores that hunt them. The white pelt of the Othan snow-cat is a regular decoration



TARQUIN

Attributes

Fitness 2

Coordination 2

Dexterity +1

Intellect 3 [6]

Presence 2

Psi 2

Range +1

Skills

Artistic Expression

(choose two

Specializations) 2 (3) and
(3)

Culture (Tarquin) 2 (3)

History (Tarquin) 1 (2)

Language

Tarquin 2

Receptive Empathy 2

World Knowledge

(Tegedaar) 1 (2)

Typical Traits

Pacifism -5*

*Violent members of the Tarquin underground must "buy off" this Trait, either during character creation or during play (using Experience Points).

for Othan warriors, who hunt the beasts in the mountains. The Othan diet depends heavily on meat, supplemented by grains and some vegetables.

The New Otha colony is similar to the homeworld in many ways: bleak, cold, and harsh. The planet has extremely rocky terrain, filled with mountain ranges, broken plains, glaciers, and numerous small lakes and seas, many of which are frozen over year-round. The colony has a population of approximately ten million Othans.

The Sankrax colony is considerably warmer than Otha-Prime, temperate by human standards. The planet raises considerable amounts of agricultural products, which are shipped to other worlds. The colonies are concentrated near the subtemperate bands nearer to the poles, where the Othans are more comfortable.

The Romulan fleet seized the D'Korin colony after a fierce battle with the Othans. The colony is under martial law until the entire Othan Sector can be pacified and placed under the rule of a regional governor. Romulan personnel consider duty on the cold, bleak planet onerous at best, particularly since the local Othans conduct terrorist activities to drive the Romulans off their world. For her part, the Romulan military governor, Commander N'vera, handles any disobedience swiftly and brutally. Round-ups and executions of suspected Othan terrorists are common occurrences.

Derex colony is nearest to the Klingon border, so it sees the most interstellar traffic in the Othan Empire. Traders passing through Klingon space sometimes stop at the colony, along with the occasional Klingon ship, but Romulan patrols have virtually halted the passage of any unloaked Klingon vessel through the area. Merchant ships still manage to pass through from time to time, usually after being stopped and searched by Romulan patrol ships. Many Klingon agents enter Othan space through Derex colony, and the Romulans work on closing off the Klingon supply pipeline to the Othans.

Tarquin Sector

Tarquin sector is located in the Beta Quadrant, coreward along the Romulan Neutral Zone. The Romulans occupied the sector a little over a century ago.

IMPERIAL POLITICAL ROLE

For the most part, Tarquin Sector is a peaceful and productive part of the Empire. The recent activities of the Tarquin separatists, however, have become reason for concern in the Romulan Senate and the military. All efforts are being made to deal with the problem quickly and quietly.

DOMINANT RACES/CULTURES

The Romulans have dominated Tarquin Sector for many years. Several other species live in the sector, notably the Tarquin, whose homeworld, Tegedaar, lies in the sector. A few other Romulan client races have colonies in the sector.

The Tarquin are a humanoid, intelligent lifeform, noted for their peaceful civilization and their love of fine art, particularly delicate pottery made from clays native to Tegedaar. The Tarquin possess gray skin, enlarged foreheads, and golden eyes. They wear full, hooded robes that shade their faces and cover their entire bodies, except for their hands, which are long-fingered and delicate. Their robes are richly patterned and colored in deep jewel tones.

The Tarquin are naturally empathic, an ability which has preserved peace and order in their society throughout their recorded history. They offered no resistance when the Romulans first came to Tegedaar and conquered it, since violence was a foreign concept to them. Since that time, many Tarquin have learned to understand the nature, and even the need, for violence.

STAR SYSTEMS

Seven systems lie within the bounds of Tarquin Sector. The Tarquin system itself and two others are inhabited. The remaining systems are home only to mining and scientific facilities (at least officially; see below).

UNUSUAL PHENOMENA

Romulan scientists believe a component of the Tegedaar ecosystem provided the Tarquin with their empathic abilities. Many Tarquin lifeforms appear to have



some sort of rudimentary psionic ability, and those who study them believe the ability may trace back to something in the food chain or other environmental conditions. Theories on the matter remain inconclusive, but a rumor among Romulan military personnel in the Tarquin Sector warns that consuming native food and drink on Tegedaar leads to an increased sympathy for the Tarquin and a general "pacifying" effect, causing people to become soft and nonviolent.

HISTORY

For millennia, the Tarquin lived as the sole inhabitants of the sector. Their civilization rested on principles of peaceful coexistence and the creation of art. The Tarquin created fantastic cities of stone, but their technology never developed much past the Renaissance level.

When Romulan explorers arrived on Tegedaar in 2264, the Tarquin greeted them with open arms. When the Romulans seized control of the planet and annexed it, the Tarquin offered only passive resistance, since violence was not part of their way of life. For the most part, it did not matter to the Tarquin who claimed control of their world, as long as they were allowed to live in peace. Tarquin artwork and *satul* pottery quickly became popular throughout the Romulan Empire, promoting a brisk trade environment.

Still, some Tarquin were unhappy under Romulan rule. Using their empathic abilities, they copied Romulan violent tendencies and passionate emotions, and took it upon themselves to drive the Romulans off their homeworld. At first, the resistance movement organized itself around such methods as passive resistance, hunger strikes, peaceful protests, and the like. The Romulans ruthlessly crushed these uprisings, rounding up Tarquin ringleaders and publicly executing them. Many other Tarquin were arrested and never heard from again, having simply "disappeared."

Although the majority of the Tarquin resistance remains peaceful, it has spawned splinter groups who no longer hold to their people's philosophy of peace. These Tarquin use their empathy to mimic Romulan aggression to commit violence, and they have aimed

several recent attacks against Romulan personnel on Tarquin III. In fact, there are disturbing implications that the more a Tarquin commits acts of violence, the more violent emotional impulses he absorbs. Violent emotions become almost like a drug to the affected Tarquin, provoking further violent behavior and a continuation of the cycle. Some Tarquin have begun to fear that the price of driving the Romulans away may be to become just like them.

IMPORTANT WORLDS

Tegedaar is the central planet of the sector. It is a lush, temperate world, filled with natural beauty and the majestic cities of the Tarquin. Some of the cities are marred by damage from terrorist attacks or graffiti proclaiming underground slogans. Romulan military personnel patrol the streets and all Romulans are asked to travel armed at all times, in case of terrorist activity.

Several small colony worlds exist within the sector. They are largely peaceful, although there is a growing concern that Tarquin terrorist cells hide out on some of them. Events on Tegedaar have increased the level of tension and security on the nearby colonies slightly.

In the lifeless Gotara System, a secret *Tal Shiar* psionics research laboratory exists on the largest moon of the Class J planet Gotara V. The laboratory studies the empathic abilities of the Tarquin for possible applications for the Mind War Division of the *Tal Shiar*.

In particular, agents dissect (and vivisect) Tarquin brains in order to study their anatomy and neurochemistry, and subject living Tarquin to a wide battery of tests to study the limits of their abilities. The *Tal Shiar* transports many Tarquin political prisoners here to take part in these experiments. The laboratory also studies samples of Tarquin flora and fauna for a possible environmental cause of Tarquin psionic ability.

Lab director Dr. Vol Janara believes he is quite close to isolating information that may allow the replication of Tarquin abilities in Romulan subjects. Dr. Janara is intensely focused on his research, and he believes the development and control of psionic abilities is the key to Romulan expansion and the future security of the Empire.

Tiber Sector

Tiber Sector is located in the Beta Quadrant, well within the boundaries of the Romulan Star Empire. It is among the sectors colonized some 100 to 150 years ago.

IMPERIAL POLITICAL ROLE

Tiber Sector has a history of strong loyalty to the Empire and a fairly conservative population. Of late, the sector has become an issue in Romulan politics because of the extensive outbreak of Phyxox Plague there. The senators of the sector have urged stronger and swifter measures from the Senate to end the plague, including the radical possibility of acquiring aid from the Federation.

DOMINANT RACES/CULTURES

Tiber Sector is dominated by several large Romulan colonies. Some members of other Romulan client races live in the sector, but the majority of the population is Romulan.



STAR SYSTEMS

Tiber Sector holds eleven star systems, five of them settled by Romulans. The remaining systems contain only lifeless worlds or have no planets at all. A few of these lifeless systems are home to renegades and criminals, who use them as safe havens from Romulan authorities.

UNUSUAL PHENOMENA

Tiber Sector currently suffers from a virulent outbreak of Phyxox Plague affecting all five inhabited systems within the sector. The Romulan Star Navy quarantines the entire sector. Travel to and from Tiber Sector is strictly prohibited except under direct order from the Romulan Senate or the Praetor. The *Tal Shiar* carefully screens and monitors all incoming and outgoing transmissions to maintain control over the situation in the sector and to prevent disturbing news from reaching other citizens of the Empire until the situation can be dealt with.

HISTORY

Romulans first explored and settled Tiber Sector around 2220. The sector contains several Class M worlds, and the early Romulan settlers found ample opportunities on the new frontier. In a fairly short time, the colonies in Tiber Sector flourished and sported magnificent cities, nearly rivaling some of the architectural wonders of Romulus itself. The planets of the sector trade heavily with each other and with the rest of the Empire. Tiber Sector is seen by many of the inhabitants as a living example of the virtues of *D'era* and what the Romulan people are capable of achieving.

Recently, Tiber Sector was struck with disaster when a strain of Phyxox Plague erupted on Tigelis VII, one of the oldest colony worlds. Carried to the other colonies by traders and tourists, the plague spread like wildfire throughout the sector. The Senate ordered the Romulan Star Navy to quarantine Tiber Sector immediately, and to avoid all contact with infected individuals to protect military personnel assigned to the blockade. Emergency medical supplies and personnel flood into the sector, but only barely maintain their ground against the progress of the plague. It continues to spread and appears to be mutating in response to Romulan medical treatments, creating new strains resistant to conventional treatments.

Romulan military personnel and agents of the *Tal Shiar* assigned to maintain order in the sector have a difficult job. The plague has made otherwise loyal citizens of the Empire paranoid and violent. Communities on various colony worlds isolated themselves in hopes of avoiding infection, and desire for additional medical treatment and assistance from the Empire has led to protests and even riots in some of the larger cities, which have been the worst hit by the plague. Although the Tiber Sector senators have pleaded for additional aid from the Senate, they have been able to assign only so many resources to the relief efforts. There is a growing concern in the rest of the Empire over the status of Tiber Sector. The *Tal Shiar* heavily edit news reports and other transmissions from the sector to prevent a panic or public outcry over the handling of the plague disaster.

Senator Jollen Merek of Tigelis VII has offered the Senate a radical solution to the Phyxox Plague crisis. Senator Merek proposed submitting a request for humanitarian aid to the United Federation of Planets, which, according to the *Tal Shiar*, successfully handled a similar, smaller outbreak of Phyxox Plague on Cor Coroli V in 2366. Unfortunately, the Cor Coroli incident was classified by Starfleet Command, so little or no information is available about how Starfleet handled the disaster. The Senate rejected Merek's proposal, preferring to avoid any appearance of weakness or incompetence before their counterparts in the Federation; if the Federation could handle the Phyxox Plague, then surely the Romulan Empire can do so as well. Meanwhile, the *Tal Shiar* has dispatched agents to retrieve Starfleet's classified files on Cor Coroli; so far, their efforts have been unsuccessful. Senator Merek, whose family lives on Tigelis VII, is skeptical that the Empire can find a solution on its own. He considers secretly contacting the Federation personally, although he knows that the *Tal Shiar* placed him under constant surveillance after he made his radical proposal.

An additional problem for Romulan ships overseeing relief efforts is the increase in piracy since the outbreak of the plague. Rogue criminal bands, operating from one of the uninhabited systems within the sector, strike at ships carrying supplies to the Tiber colonies, hijacking their cargoes and killing the crews. They then sell the supplies on the black market to those able to meet the hijackers' prices. The attacks have resulted in stronger protests by the Tiberian colonists and increased military patrols and escorts of cargo vessels through the sector.

IMPORTANT WORLDS

Tigelis VII is the oldest and largest colony world in Tiber Sector. It is a lush, temperate planet covered with old-growth forests and high, snow-capped mountains. Several Romulan cities and settlements dot the planet, including the capital city of Ronikar, with its tall, silvery spires reaching up into the pale blue sky by the shores of the shining sea. The population of Tigelis has been in chaos since the start of the Phyrox outbreak. Medical facilities overflow with plague victims, well beyond their ability to treat or even house them all. Smaller, more isolated communities have cut themselves off from the outside world completely, and forbidden all travel in order to try to prevent infection. One or two other smaller communities lie practically depopulated by the plague, leaving them virtual ghost towns.

Romulan military personnel in biological protection gear patrol city streets and strictly enforce curfews and travel restrictions. The Romulan authorities are doing as much as possible to alleviate the needs of the population, but relief efforts are only barely adequate. Civil unrest has become more and more common, with protests and the occasional riot as the citizens of Tigelis call for more help from their government.

The other inhabited worlds of Tiber Sector face similar dire straits. Shortages of all kinds have forced many to turn to a thriving black market, where pirates and rogue traders sell needed supplies to the highest bidder. Many of these supplies are stolen from legitimate Romulan relief shipments, while the rest are smuggled secretly into the sector. The Romulan authorities (particularly the *Tal Shiar*) work to close down the black market and arrest any smugglers, but they have their hands full keeping the civilian population under control and simply don't possess the personnel or resources to track down the black marketeers.

The strongest pirate haven in the sector is hidden in the Roulean System, based in a cluster of large asteroids in the Roulean Belt. The pirates are a motley collection of Romulans, Ferengi, and Romulan client races led by a "rogue" Ferengi DaiMon named Grax, clustered around various stolen and patched-together vessels, mostly Romulan and Klingon. The pirate ships use cloaking devices, making them difficult to detect, although their cloaking technology is antiquated and often in poor repair, allowing a skilled sensor operator to pick up the ships with a Difficult Shipboard Systems (Sensors) test.

The pirates have contacts throughout the Tiber Sector and plot their attacks on Romulan shipments through the region using the information they gather. They also operate a lucrative smuggling operation in the sector, using various hidden bases as "drop points." The pirates have struck at several Ferengi trading ships as part of a secret agreement with certain Ferengi. They sell the "stolen" cargo for a substantial profit (well above market value), and the Ferengi Alliance is able to protest to the Romulan government and gain an advantage in negotiations. The Ferengi naturally will deny any knowledge of this arrangement, if it is uncovered.

Tullus Sector

Tullus Sector is located in the far reaches of the Beta Quadrant, on the frontier of the Romulan Empire, leading into unexplored space. It attracts Romulan explorers and adventure-seekers from all corners of the Empire.



IMPERIAL POLITICAL ROLE

Tullus Sector has no Romulan settlements or colonies and little or no interaction with Romulan politics.

DOMINANT RACES/CULTURES

Tullus Sector contains two intelligent species, neither of which possess sophisticated interstellar travel.

The N'virii are a hive-mind insect species from the second planet of the unexplored Farlorn System. They are vaguely humanoid, standing upright on their rear legs and possessing two pairs of upper limbs along their thorax/torso. They are covered in hard, chitinous shells and possess limited (Level Two) technology. N'virii colonies are ruled by a Queen Mother, a bloated, immobile female of their species with powerful telepathic abilities, allowing her to remain in contact with all her N'virii "children" and direct them, providing the central intelligence for the colony. Queens cannot exist in close proximity to each other; their instincts drive them to try to destroy their "rival," leading to wars between colonies. Farlorn II contains considerable mineral resources, and the fantastic hive-like cities of the N'virii hold a wealth of biotechnological information and resources, including *pless*, the honeylike food produced by N'virii worker drones.

The other species native to the Tullus Sector are the Pollarians, the inhabitants of a large Class M moon in orbit around the superjovian Class J planet Pollus VIII. The Pollarians are humanoid, with large, dark eyes and wide ears. They are quite pale, since the light on their homeworld is dim, and they have very sensitive hearing. Pollus VIII radiates considerable amounts of heat, keeping the moon's surface climate tropical. The Pollarians have an early industrial civilization (Level Four) based around the exploitation of their world's mineral resources. Divided into separate nations, they occasionally war over control of resources.

The Breen have explored parts of the Tullus Sector, and made contact with the Pollarians almost five years ago. In exchange for technology, the Pollarians trade the



N'VIRII (SOLDIER)

Attributes

Fitness 3 [6]

Coordination 2 [6]

Intellect 2 [3]

Logic -1

Presence 3 [4]

Empathy -2

Psi 0 [0]

Skills

Culture (N'virii) 2 (3)

History (N'virii) 1 (2)

Language

N'virii 2

Primitive Weaponry (choose
Specialization) 2 (3)

Unarmed Combat
(Wrestling) 1 (2)

World Knowledge
(Farlorn II) 1 (2)

Typical Traits

Ambidexterity +2,

Armor (2 pts) +4

POLLARIANS

Attributes

Fitness 2 [4]

Strength -1

Coordination 2 [5]

Dexterity +1

Intellect 2 [5]

Presence 1 [4]

Psi 0 [5]

Skills

Culture (Pollarian) 2 (3)

History (Pollarian) 1 (2)

Language

Pollarian 2

Merchant (Any) 2 (3)

Science (any) (choose
Specialization) 1 (2)

Stealth (Hide) 1 (2)

World Knowledge (Pollus VIIIa) 1 (2)

Typical Traits

Alertness +2

Enhanced Vision +2

Excellent Hearing +2

Breen some of Pollus' dilithium deposits. Because of Pollus' tropical climate, the Breen wear sealed life-support suits there. Cloaked Breen ships regularly pass through the Pollus system, and they have a strong interest in protecting their exclusive trade agreement with the Pollarians.

The Taurhai have also explored several of the systems in this sector, although currently Taurhai vessels are rarely spotted in the region. The status of Tullus Sector may become disputed between the Taurhai Unity and the Romulan Empire unless the Romulans quickly establish a claim on it.

STAR SYSTEMS

Tullus Sector contains a globular cluster of eighteen densely grouped star systems. The Romulans have charted, but not explored, the three systems closest to the Romulan border. The only information they have on the remaining systems comes from long-range scanners and probes. Information on those systems remains sketchy.

HISTORY

Tullus Sector is on the frontier of the Romulan Empire, a new region open for exploration by the ships of the Romulan Star Navy. The Senate has allocated resources for an exploration of Tullus Sector with an eye toward establishing some new colonies in the area, as well as conquering any indigenous species that might live there. The sector lies fairly close to the space claimed by the Taurhai Unity, so all Romulan vessels in the sector are advised to use caution in dealing with alien vessels and to avoid conflict with the Taurhai if at all possible.

IMPORTANT WORLDS

Farlorn II is the homeworld of the N'virii. It is a small, temperate world dotted with numerous lakes, rivers and swamps. Along the planet's flood plains and other open areas rise the hive-cities of the N'virii, constructed from a native building material similar in appearance and composition to concrete. The cities are tall and crowded, buzzing with millions of N'virii drones and soldiers going about their business. The planet has a tremendous variety of insect species, along with some reptiles and fish, but no mammals. The environment is also home to many exotic bacteria and vires, some of which may have unexpected effects on mammalian biology.

Pollus is the home system of the Pollarians, who live on Pollar, the largest moon in orbit around the super gas giant Pollus VIII. The moon has rough, mountainous terrain and a dim, tropical environment filled with a broad variety of plant and fungal life that thrives in the heat and dim light. Pollarian cities tend to be built similar to the cliff dwellings of many species, clinging to the sides of mountain valleys. The mountains are rich in many minerals, including dilithium, which the Pollarians mine in order to trade with the Breen.

Drovna III is an M-class planet ripe for colonization. It contains only primitive native life forms (primarily plant life). It also holds ancient ruins of an extinct civilization that died out hundreds of thousands of years ago. The ruins hold no indications of advanced technology, only stone buildings, statues, and carvings. Some of the crystals found within the ruins, however, contain information encoded on the molecular level, similar to isolar computer chips. The information reveals that Drovna III was terraformed by an unknown race more than 500,000 years ago, but does not reveal the name of that species or why they later abandoned the planet.

Venturius Sector

Venturius Sector is located in the Beta Quadrant, close to the Romulan Neutral Zone.

IMPERIAL POLITICAL ROLE

In addition to its strategic importance along the Neutral Zone, the sector is home to several Romulan colonies, as well as a secret Romulan Astrophysical Academy research center. The senators from the colonies in the area are aware of the research project but do not know its full extent, which the *Tal Shiar* has classified for security reasons. Each senator hopes to learn more information about the project, both to gain a valuable resource and secure more power within the Senate.



DOMINANT RACES/CULTURES

Venturius Sector is controlled entirely by Romulans. Any native cultures in the sector died out millennia ago, although evidence of their presence still remains in some cases.

STAR SYSTEMS

There are five systems in Venturius Sector, three inhabited by Romulans. The colonies in the sector are fairly new, less than a century old.

UNUSUAL PHENOMENA

The Hellaro Corva system is home to an unusual black hole being studied by the Romulan Astrophysical Academy. The black hole—known locally as “the Eye of Corva”—was once the companion star of a close binary system, and orbits Hellaro Corva at a distance of .74 AU. The formation of the Eye of Corva destroyed the system’s inner planets. Stellar gases are drawn off the surface of the star by the intense gravitational pull of the black hole, creating an incandescent streamer of hot gases spiraling out into space. The interaction of the stellar gases with the black hole’s event horizon makes the outer edges of the Eye of Corva visible at the heart of the black hole. A space station in orbit of Hellaro Corva II (formally Hellaro Corva VII) takes regular astrometric readings of the black hole and studies it for greater understanding of quantum singularity phenomena, which may be used to improve Romulan engine and warp-drive technology.

HISTORY

Venturius Sector is on the Federation frontier of Romulan space. It was first charted around the time of the Earth/Romulan War 200 years ago, but not explored until much later. The establishment of new Neutral Zone boundaries by the Treaty of Algeron allowed for colonization in the sector, and three Romulan colonies have been established in the past fifty years. The discovery of a stable black hole in orbit of Hellaro Corva resulted in

the establishment of a Romulan research station there a few years ago, drawing additional attention to the sector.

The senators from the colony worlds hope to use this new attraction to gain additional resources from the Senate for their worlds. Thus far, the Romulan Senate has been unusually cooperative in granting the senators’ requests, leading them to wonder about the nature of the research project in the Hellaro Corva System. The senior of the three senators, Vargo Dorek, has made discreet inquiries about the research, only to discover that the *Tal Shiar* has classified parts of it. Rather than dissuading him, this has only piqued the senator’s curiosity. He hopes to use some of his contacts in the Romulan Star Navy to find out more. He anticipates being able to parlay the information into greater influence within the Senate and more resources assigned to the colonies in Venturius Sector.

IMPORTANT WORLDS

While the Eye of Corva is a spectacular and scientifically fascinating phenomenon, it is not the true reason for the presence of Romulan scientists in the system. The second planet of the system, Hellaro Corva II, holds ancient ruins that the Romulans believe are from the Iconian civilization that vanished some 200,000 years ago. The planet is completely airless and lacking in any surface water. The scientists believe it may have had an atmosphere at one time, but that it was destroyed in some cataclysm, possibly triggered by the Iconians. The gravitational forces of the Eye of Corva as it orbits the star create tremendous tidal stresses on the planet, making quakes a common occurrence.

The quakes hinder the work of archaeologists on the surface and slow the progress of examining the ruins. Thus far, they have uncovered only primitive artifacts, but the glyphs and symbols on them appear Iconian. Scientists hope to discover some remnants of Iconian technology in the ruins. Dr. Fel Honora, the head of the research project, has some radical theories concerning the Iconian presence in the system. She believes the Iconians were responsible for the formation of the Eye of Corva, either as an intentional project in stellar-quantum engineering, or as an accidental outcome of some experiment or mistake, perhaps the same one which resulted

THE TAURHAI

Suggested Attribute and Edge Ranges

Fitness 2 [5]

Vitality +1

Coordination 2 [5]

Dexterity +1

Intellect 2 [6]

Presence 2 [6]

Empathy +1

Psi 0 [6]

Special or Unique Abilities

The Taurhai have technology in advance of that possessed by the Romulans, the Federation, and most other interstellar civilizations in the Alpha and Beta Quadrants.

Special or Unique Skills

Higher-ranking Taurhai nearly always excel in a broad range of skills from many different fields.

Size

Taurhai are slightly taller than humans on average, standing around two meters tall. Their thin build emphasizes their height.

in the loss of Hellaro Corva II's atmosphere. Either way, she is certain that the black hole is not a naturally occurring one, but engineered. She hopes to find the key to unlocking the mystery within the Iconian ruins.

Dr. Honora's assistant, Ulan Braka, is an undercover agent with the *Tal Shiar* sent to spy on the research project and monitor its progress. Braka has orders to report at once if the researchers uncover any Iconian technology, and to ensure that their finds are turned over to the *Tal Shiar* as soon as possible. He also watches the science staff for any signs of disloyalty and monitors all communications and passing ships to ensure no security leaks, particularly this close to the Neutral Zone. Braka is quite taken with Dr. Honora's brilliant mind and attractive features, but the doctor has eyes only for her work and has ignored Braka's occasional signs of interest in her. The *Tal Shiar* spy has not allowed his infatuation to interfere with his work, but he might find himself torn if it comes down to betraying Dr. Honora or fulfilling his oath as a member of the *Tal Shiar*.

Venturius Sector is also home to the Agurthan Outpost, a Romulan colony world and military base along the border of the Neutral Zone. The outpost keeps careful watch over the Neutral Zone for any signs of Federation intrusion and maintains readiness to repel any such incursions. With the relative closeness of the Hellaro Corva system, the outpost also has a number of *Tal Shiar* agents assigned to watch for signs of Federation espionage.

Y'varian Sector

Y'varian Sector is on the frontiers of Romulan space in the Beta Quadrant, near the border of the Romulan Empire and the Taurhai Unity.

IMPERIAL POLITICAL ROLE

Until recently, Y'varian Sector was one of many embroiled in a war between the Romulans and the Taurhai Unity, a neighboring interstellar empire. With the cessation of hostilities between the Romulans and the Taurhai, this sector has become the center for a new peace initiative, where Romulan and Taurhai representatives work to negotiate a treaty between their two civilizations. The sector has attracted the attention of the Romulan underground, since the Taurhai agree with many of their ideals. Several Romulan colonies seized by the Taurhai remain under Unity control, creating some political tension and instability in the region.

DOMINANT RACES/CULTURES

The possession of Y'varian Sector is currently disputed between the Romulans and the Taurhai. The Romulans have several new colonies in the sector, while the Taurhai seized control of a Romulan colony and established one of their own. Romulan culture predominates in the sector, but the Taurhai are becoming more influential, and there is some Romulan concern over the long-range impact of the Taurhai presence (especially in light of the Taurhai's superior technology). The treaty negotiations will determine which civilization will have ownership of the sector, and the fate of the colonies in it.

STAR SYSTEMS

There are eight systems in Y'varian Sector, five of which are inhabited. The Romulans maintain two colonies nearest the Romulan side of the sector, well protected by Romulan ships and a network of early-warning satellites (which are of only limited use against Taurhai ships). Near the Taurhai side of the sector are two other colonies, one a Romulan colony seized by the Taurhai and the other a Taurhai colony on the outskirts of the sector. The central system, the Paxar system, is the location of the Romulan/Taurhai peace talks.

HISTORY

Y'varian Sector is a frontier region for both the Romulans and the Taurhai. The Romulans began exploring and establishing colonies in the sector first. When the Taurhai attacked the Romulan Empire (see page 21), several of the colonies in the Y'varian Sector were the first to fall to the Taurhai onslaught. The Taurhai placed the planets under their control and began the process of "helping" their Romulan populations realize the errors in their culture and traditions, educating them to the civilized ways of the Taurhai Unity.

Following the Romulan counteroffensive against the Taurhai homeworld, the Taurhai withdrew from all but one of the sector's Romulan settlements, and the Romulans have begun the process of rebuilding their colonies. Both sides agreed to a series of meetings conducted on Paxar IV to negotiate a peace treaty between the Empire and the Unity. The Romulans host the negotiations, but the process has been extremely slow, given the differences between the two societies.

Both sides have proposed, and alternately rejected, various proposals, including the creation of a neutral zone between the Empire and the Unity, the formation of independent "buffer states," and even an eventual unification between the two sides (proposed by the Taurhai). The creation of some type of neutral zone seems the most likely prospect at this time, but both sides cannot agree on the boundaries of such a zone, as well as the fate of the systems and worlds falling within this new zone. The two sides also disagree about the continued use of Taurhai subspace ships, which are capable of bypassing Romulan defensive systems, and of Romulan cloaking systems, which are capable of defeating Taurhai sensors.

IMPORTANT WORLDS

Paxar IV, an uninhabited Class K planet, is the location of the Romulan/Taurhai peace talks. The conference talks take place on board Paxar Station, in orbit above the planet. The Romulans constructed the station specifically for the peace negotiations, providing facilities for all the delegates, their staffs, and the Romulan and Taurhai military personnel stationed there.

Both Romulan and Taurhai ships are allowed free passage through the system, but security on the station remains tight, to avoid the possibility of treachery or terrorist activities. The Romulans prefer to keep their contact with the Taurhai secret from other interstellar powers, like the Federation and the Klingon Empire, so *Tal Shiar* agents strive to prevent any security leaks and to keep the Taurhai delegates isolated from any "dangerous" information. For their part, the Taurhai respect the peace of the station and do not cause trouble. They spend their time observing the Romulans, learning all they can about Romulan civilization, while doing their best to demonstrate their superior culture by example.

A prime point of contention in the peace negotiations is Gaius, a Romulan colony world on the Taurhai side of the Y'varian Sector. The Taurhai seized control of Gaius early in their conflict with the Romulans and have retained control of it ever since. The Taurhai attempt to convince the several thousand Romulan colonists on Gaius of the correctness of Taurhai culture, demonstrating how Romulan culture has gone wrong. Although many Romulans cling to their cultural beliefs, many others have been swayed by the Taurhai, leading to a rift in the population between those who oppose Taurhai occupation and those who welcome the Taurhai and their ways. The Taurhai claim the Gaian colonists wish to join the Taurhai Unity, while the Romulans maintain that Gaius is their world and deny any claim on the part of the Unity.

Several Taurhai aides on Paxar Station are Romulan Taurhai sympathizers from Gaius. The *Tal Shiar* has these individuals under close surveillance to determine if they have been in some way brainwashed or otherwise influenced by the Taurhai, and to learn more about the current situation on Gaius. The Romulan military secretly smuggles weapons and supplies to loyalist Romulans

on Gaius to help them overthrow the Taurhai, but the Romulan Senate does not wish to antagonize the powerful Taurhai and risk a renewed conflict, so the shipments are conducted with the utmost secrecy.

The Taurhai

HOMEWORLD

Chi'tan, the central world of the Taurhai Unity, is a highly advanced world where a sophisticated technological culture coexists peacefully with the natural environment. Chi'tan suffered considerable damage during the recent conflict between the Taurhai and the Romulans, and is in the process of being restored to its former glory.

HOME REGION OR SOVEREIGN TERRITORY

The Taurhai Unity is an interstellar civilization located in the Beta Quadrant, bordering on the Romulan Empire's antispinward flank.

TRAITS COMMON TO THE SPECIES

The Taurhai have an enlarged cranium and beveled brows, coupled with a fairly narrow, pointed chin and a small mouth. They have dark hair, typically worn long, but the top of the head is bald. They have no eyebrows and their eyes are completely black, containing no iris or pupil. Taurhai body and limbs are long, slender, and graceful, and they have long, dexterous fingers. Taurhai skin color ranges from pale tan to dark brown. They typically wear long robes with wide sleeves, decorated with glyphs and symbols representing the individual's various achievements.

STORY NOTES

The Taurhai provide a formidable adversary for the Romulan Empire, having technology superior to the Romulans and a cultural imperative that forces them into conflict. They can also provide an unusual dilemma for Federation characters. Taurhai culture and ideals are similar in many ways to those of the Federation and Starfleet: equality, personal excellence, and the quest for knowledge and understanding. Were they to encounter the Federation, the Taurhai would likely seek an alliance.

Unfortunately, the Taurhai do not believe in the Federation's policy of nonintervention, placing their own culture above those of other species; the Taurhai believe their superior ideology must be vigorously exported, by force if necessary. Although Taurhai culture has much in common with the Federation, their superior attitude and interference in the development of other civilizations makes them suspect.

DESCRIPTION

The Taurhai are a humanoid race that first developed civilization on their homeworld of Chi'tan tens of thousands of years ago. Since that time, they have followed a steady path of progress up the evolutionary and technological ladder, and are now intent on helping to bring other species along with them.



TAURHAI STARSHIP PROPULSION

Sublight propulsion is provided by gravity induction, allowing the Taurhai ship to "fall" in any direction and at speeds approaching the fastest impulse drive. This generates a graviton wavefront around the Taurhai ship detectable by gravimetric sensors.

Taurhai ships have no warp-drive capabilities. Instead, they utilize their graviton projectors to open "funnels" through subspace, much like small temporary microwormholes. The Taurhai ship "falls" or "slides" through the funnel and exits immediately on the other side vast distances away. This method allows Taurhai ships to cross light years instantly, although very long distances often require several "jumps" to cross.

Since a Taurhai ship is undetectable until it exits subspace, the Taurhai are able simply to appear in areas of space without warning. During their conflict with the Romulans, the Taurhai used this ability to good advantage for staging surprise attacks.

Taurhai society is based around individual achievement and excellence, a quality they refer to as *taurite* (tor-ree-TAY). Each Taurhai works to become the most developed, skilled, and capable person he can be. Taurhai are encouraged to seek excellence in whatever fields they are most suited for, and to broaden their skills and knowledge continually into new fields of endeavor.

Their society produces fantastic amounts of art, architecture, culture, and science, and such achievements are valued and recognized by other Taurhai. By following the precepts of *taurite* and seeking perfection, the Taurhai believe they add to the substance of the universe, and contribute to the continued development of their species as a whole.

The Taurhai philosophy includes a strong sense of duty and responsibility. Taurhai do not seek *taurite* merely for self-aggrandizement, but to take what they have learned or created and use it to benefit others less fortunate than they. This philosophy allowed the Taurhai to create a peaceful culture devoted to progress and the improvement of quality of life for all members of the society, rather than simply a privileged elite based on things like wealth or heredity. To the Taurhai, all achievements come full circle, serving the public good in myriad ways.

As might be expected, the Taurhai have a love of activities which allow them to excel, like organized competitions, sports, puzzles and tests of mental and intellectual prowess, and so forth. Their competitions are rarely adversarial. Each Taurhai strives to achieve more than he has before, and individual achievement is recognized more than winning competitions. The Taurhai claim their species is insatiably curious and cannot resist a challenge. The Taurhai always want to know what is on the other side of a mountain, or what lies in the uncharted regions of space. Their curiosity and thirst for knowledge make the Taurhai capable scholars, scientists, and explorers.

Modern Taurhai culture is a meritocracy, a government by those who have achieved the most in society. The Taurhai Unity is ruled by a Council of Worthies, recognized as the most accomplished members of society, the wisest and most capable of the Taurhai themselves. They are chosen as part of a lengthy competition among the various contenders, and they are expected to maintain the highest standards of excellence for themselves and their subordinates. They provide an example to the rest of their people of the heights that they can achieve.

Taurhai society is stratified based on individual achievement. The Taurhai recognize that all lifetimes are entitled to certain rights of dignity, fair treatment, and freedom from war, hunger, and other basic concerns. By the same token, the Taurhai know that all beings are not "equal." Individuals must be judged on their actions and achievements, rather than any preconceived notions. Work is performed by those best suited to do it. A Taurhai laborer highly skilled at his job receives nearly as much recognition as a great statesman, scientist, or athlete. Those Taurhai who achieve more receive great responsibilities and opportunities, while underachievers are entrusted with fewer important tasks (but retain the opportunity to redeem themselves). Taurhai who achieve the most have a responsibility to help guide those who have achieved less, for the good of all.

When they ventured out into space, the Taurhai applied their philosophy of *taurite* to other species they encountered. The first race the Taurhai met were the Biloreans, a humanoid species that had reached early Level Five technological development. Bilor II, their homeworld, was torn by wars over the division of land and differences in philosophy. Using their superior technology, the Taurhai put an end to these wars and forced the Biloreans to deal with each other without violence. They taught them the ideals of *taurite* and how to live together in peace. The Biloreans abandoned their primitive ways and were soon assimilated into the Taurhai Unity.

Over the centuries, the Taurhai have encountered many other species on hundreds of different worlds. Each time, the Taurhai encountered a less-developed species in the throes of development and, each time, the Taurhai offered their assistance, their wisdom, and their experience to help elevate the species above its humble beginnings to become a productive member of the Unity. In this way, the Unity grew and the influence of the Taurhai spread. Assisting each new species often took considerable time, but the Taurhai considered it their duty, as the most developed species, to assist the less-developed.

CONFLICT WITH THE ROMULAN EMPIRE

The Taurhai first encountered the Romulans in 2309 when a Taurhai exploratory vessel made contact with a Romulan patrol ship on the edge of Romulan space. The Taurhai greeted the Romulans peacefully, but were met with distrust and caution. The Romulans allowed the Taurhai to make the first move, in order to gauge their intent and capabilities. The alien vessel simply requested

an exchange of knowledge and diplomatic greetings, and offered information about the Unity, the Taurhai, and their culture. In return, the Romulans ordered the Taurhai to respect Romulan borders and withdraw from Romulan space, which they did.

Upon studying the information about the Romulans, the Taurhai were disappointed. Although they possessed some technological sophistication and controlled a large interstellar Empire, the Romulans were not as developed as the Taurhai first had hoped. They were paranoid, isolationist, and warlike. They took what was given to them without offering anything in return. Clearly, the Romulans were a species in need of what the Taurhai had to offer, whether they wanted it or not.

Having reached this conclusion, the Taurhai Unity sent a second vessel into Romulan space in 2313. The ship made contact with a Romulan outpost and offered to share the Unity's advanced technology as well as the "cultural education" the Romulans required to become a "civilized" species. The Romulans correctly interpreted this message as a prelude to war and opened fire on the Taurhai ship. The retaliation crippled the outpost's defensive systems, and the Taurhai destroyed the Romulan warbird sent to intercept their ship. The Taurhai vessel then vanished from normal space, down some type of "subspace funnel," using technology previously unseen by the Romulans. From that moment, the Romulan Empire and the Taurhai Unity were at war.

From the very beginning the Unity's goals were clear: They wished to put an end to Romulan aggression and to "correct" their militaristic and racist culture—by force, if necessary. The Taurhai had no wish to harm the Romulans, but would not be swayed from their obligations to them and to the rest of the galaxy. They would save the Romulans from their barbaric culture, even if they had to destroy it and force it to begin again.

For their part, the Romulans found the Taurhai a far greater threat than any enemy they had ever faced. Not only were the Taurhai technologically superior to the Romulans, but they challenged everything the Romulans held dear. They dared to consider the Romulan Star Empire, the greatest civilization in the galaxy, to be nothing more than a group of savages. They denied the truth of *D'era* and wished to impose a weak philosophy, like that of the Federation, upon the Romulans. Although the Romulans found themselves greatly outmatched against the Taurhai, not a single vote in the Senate went against the declaration of war. Any true Romulan preferred death to the destruction of the values upon which the Empire was built.

To deal with the Taurhai threat, the Romulans severed contact with other civilizations, particularly the Federation, whom they feared the Taurhai might see as potential allies. The Empire devoted all its resources to war preparations, and began developing more advanced ships and weapons to fight the Unity.

The initial stages of the war went quite badly for the Romulans. Taurhai ships and technology outmatched the Empire at every turn. The Romulans quickly discovered that their cloaking technology was all but useless against Taurhai sensors, and that their disruptors and torpedos were inferior to Taurhai shields. Using their subspace funnel technology, Taurhai ships could appear virtually anywhere, strike, and withdraw before the Romulans could respond. The Taurhai always carefully restricted themselves to military targets, avoiding damage to civilian populations and sites, and the Romulan military struggled to replace their losses and build newer and more powerful ships.



Finally, the Empire's finest military and strategic minds estimated it was only a matter of time before the Taurhai broke down Romulan defenses and overran the Empire. The Romulans found themselves fighting a war of attrition, and the Taurhai could afford to take as much time as was needed to wear down the Empire's forces. If the Romulans had any hope of winning the war, they needed to go on the offensive, to take the fight to the Taurhai themselves. If they could strike a critical blow against the Taurhai, the Romulans might be able to force them back.

This daring plan called for a fleet of Romulan warbirds using improved cloaking technology to invade Taurhai space. The Romulan leaders hoped the new cloaking system might conceal the warbirds from Taurhai long-range sensors, long enough for the fleet to reach Chi'tan, the Taurhai homeworld. There the Romulans would carry out a savage bombardment of the planet's surface, an attack intended to demoralize and dishearten the Taurhai. The Romulans suspected that, like the Federation, the Taurhai lacked the stomach for a real war.

The gambit paid off, and the Battle of Chi'tan in 2343 spelled victory for the Empire. Although Taurhai defense forces destroyed many of the attacking Romulan ships, the bombardment of their homeworld forced the Taurhai to retreat back into their own space, and ended their attacks on Romulan worlds. In the peace negotiations that followed, the Taurhai agreed to respect the Empire's borders and the Romulans agreed to avoid Taurhai space.

Although the savagery and cleverness of the Romulan attack surprised them, the Taurhai have not given up on their plans. More than ever, they believe the Romulan Empire poses a threat to more civilized species and must be dealt with. The Romulans proved to the Taurhai that they still have new things to achieve, and the Taurhai enjoy nothing more than a good challenge.

TAURHAI TECHNOLOGY

The Taurhai Unity rests on the cusp of Level Seven technological development. Their technology includes sophisticated gravity control, the creation of temporary

TAURHAI STAR DRAGON-CLASS STARSHIP

Class and Type: Taurhai Star Dragon class

Hull Characteristics

Size: 10 (1,500 meters long, 55 decks)

Resistance: 5

Structural Points: 200

Operations Characteristics

Crew/Passengers: 1,500/6,000 [7 pwr/round]

Computers: 4 [4 pwr/round]

Transporters: 8 of each type [12 pwr/round]

Tractor Beams: 1 av, 1 fv, 1 fd [2/rating used]

Propulsion and Power Characteristics

Subspace Funnel System: [1 pwr/parsec]

Impulse System: .75c/.9c [7/9 pwr/round]

Power: 250

Sensor Systems

Long-range Sensors: +2/14 light years [6 pwr/round]

Lateral Sensors: +2/1 light year [4 pwr/round]

Navigational Sensors: +1 [5 pwr/round]

Sensors Skill: 5

Weapons Systems

Heavy Graviton Beams

Range: 10/30,000/100,000/300,000

Arc: All

Accuracy: 4/5/7/10

Damage: 28

Power: [28]

Weapons Skill: 5

Defensive Systems

Taurhai Absorption Field

Protection: 80/100

Power: [80]

Description/Notes: Taurhai starships, nicknamed "star dragons" by the Romulans, are long and sinuous. Their design uses modular segments connected in a series behind a main engineering and command section. Structural force fields and gravity induction units are used to control the shape and position of the individual segments, allowing the ship to make some very novel maneuvers by "coiling" and "bending" as needed.

The heart of the ship is the wedge-shaped command and engineering section. The bottom of this section is flat, with concave gravimetric deflectors to port and aft. The dorsal surface curves down from the aft portion of the wedge, thinning out toward the edges, similar to the saucer section of many Federation starships.

This section of the ship contains the command center and engineering systems, including the sophisticated graviton control systems which provide propulsion and power the subspace drive system. Taurhai ships are powered by total matter/energy conversion, transforming any type of matter (usually stored stellar gases like hydrogen) into pure energy. This allows for ships to function for unlimited periods of time without need for refueling.

Sublight propulsion is provided by gravity induction, allowing the Taurhai ship to "fall" in any direction and at speeds approaching the fastest impulse drive. This generates a graviton wavefront around the Taurhai ship detectable by gravimetric sensors.

subspace "funnels" that connect distant points in normal space, and advanced manipulation of matter and energy. Their knowledge of subspace is particularly developed, and forms the basis for much of their technology.

A standard piece of technology used by all Taurhai is the *shen*, a combination tool, weapon, and social symbol. A *shen* is an ornate metallic rod, approximately half a meter in length, decorated with engravings, precious metals, and gemstones. The decorations on the *shen* signify its owner's achievements and rank in Taurhai society.

The rod is packed with complex nanocircuitry and a compact power source, allowing it to function as a computer and communications device. It routes transmissions through subspace, giving the *shen* virtually unlimited transmission range (although extreme long-range transmissions still require some time to reach their destination). A *shen* displays information through holographic projection and contains sensor devices more sophisticated than a standard Starfleet tricorder.

The tip of the *shen* contains an advanced microtransporter device that can instantly replicate various tools and attachments at the end of the rod. If a Taurhai engineer requires a particular tool, he simply reconfigures his *shen* to provide it. Thus, a *shen* functions as a universal toolkit. The microtransporter can only affect relatively small amounts of mass, up to approximately 10 kilograms, allowing a *shen* to transport small objects anywhere within its owner's line of sight.

The microtransporter beam can also become a deadly disruptor beam on command. The pale violet beam of energy from the end of the *shen* can completely vaporize almost any substance, doing damage similar to that of a Federation phaser rifle.

The surface of the *shen* is equipped with a neural induction interface. The device interfaces with its owner's brainwaves through touch, with no external controls needed. This interface serves as an effective security measure; if the *shen* detects a different neural pattern, it locks out all functions. If it detects a non-Taurhai brainwave pattern, the *shen* uses its own transporter field to disintegrate itself. This prevents *shen* from being captured and falling into alien hands.

Taurhai transporter and replicator technology is capable of producing exact copies of objects down to the quantum level. The Taurhai do not duplicate living beings, because they consider it a violation of the individual's unique achievements. They can, however, reproduce all the other necessities of life at will. Taurhai artists still create original works by hand, but common items are all replicated. These devices have eliminated the need for manual labor among the Taurhai as anything other than a hobby or an art form.

WORLDS OF THE EMPIRE



The Romulan Star Empire encompasses hundreds of star systems and many hundreds of planets, far more than could be described in a book several times this size. This section provides profiles of a number of different Romulan worlds to offer the Narrator a sample of the variety found within the Empire, and to provide examples for the creation of new Romulan worlds. These planets are given in the standard format described on pages 256-260 of the *Star Trek: The Next Generation RPG*.

Agurthan Outpost

Planet Name: Agurtha

Class: M

System Data: One moon, with a Romulan monitoring base equipped with subspace telescopes and other equipment to keep a watchful eye on the Neutral Zone.

Gravity: 1.06 G

Year and Day: 412/26

Atmosphere: Oxygen-nitrogen at slightly lower than Earth-normal pressure.

Hydrosphere: 60% contained in four large oceans; numerous small lakes and seas.

Climate: Warm and damp at the equator, temperate toward the poles. Wide seasonal variations in weather. Powerful storms are common near the equator in spring and summer, becoming less frequent toward the polar regions.

Sapient Species: Romulans. No native sentient species, although many forms of plant and animal life (both native and imported) are abundant.

Tech Level: Level Six (Romulan)

Government: Military oligarchy

Culture: Romulan culture, with a strong paramilitary bent. The vast majority of people on Agurtha serve or are related in some way to the Romulan military presence in the area. There is strong support for the ideals of *D'era* and the Romulan Star Navy, and strong distrust of the Federation and its citizens. Outsiders are viewed with suspicion and are always reported to the authorities.

Affiliation: Romulan Star Empire

Resources: Agurtha has sufficient resources to make the outpost self-sufficient for all of its regular needs. Specialized military equipment and technology are supplied by the Romulan government.

Places of Note: Agurthan Outpost is the largest settlement on the planet, a small city of just over a quarter million Romulan citizens. The outpost has

a large military base for the Romulan troops on the planet, along with civilian support facilities and quarters for family members and other personnel. The primary duty of monitoring the Neutral Zone lies with the lunar base (which does not have to contend with atmospheric distortions or other such problems), but the majority of Romulan personnel live on the planet.

Ship Facilities: The Agurthan Outpost has facilities for the repair and maintenance of Romulan ships and other vessels friendly to the Empire. Romulan patrol vessels regularly pass through the area on routine patrols of the Neutral Zone border, and can be refueled and resupplied at the outpost. Shore leaves for Romulan crews are also common on Agurtha, which offers vast areas of unspoiled territory suitable for camping and hunting, along with the recreational facilities of the outpost itself. The outpost maintains a number of small interceptor craft for the defense of the outpost and the Neutral Zone border against any attack.

Other Details: The Agurthan Outpost is one of the more popular along the border of the Neutral Zone between the Romulan Empire and the United Federation of Planets. Many of the border outposts along the Neutral Zone are located on desolate F and K Class worlds, either on the surface in pressure domes or based on orbital facilities. In addition to being an outpost, Agurtha is also a thriving Romulan colony world, a monument to the ideals of *D'era* and a symbol to all those who would challenge the destiny of the Romulan people to conquer the stars. Agurtha is located on the far side of the Neutral Zone from the Delta Quadrant, so it did not suffer the fate of several other Romulan border colonies which were attacked and assimilated by the Borg.

Since the outpost is located in the same sector as the Hellaro Corva research station, the *Tal Shiar* pay particular attention to the goings-on at Agurthan Outpost and

carefully monitor all traffic through the sector. Many *Tal Shiar* agents have been placed on the planet, and a *Tal Shiar* liaison is assigned to work with the commander of the outpost. According to the *Tal Shiar*, these measures are merely "routine," but the commander and his senior officers know there is something going on, although they do not know what. The true purpose of the Hellaro Corva research center is not commonly known, although several people suspect that is what the *Tal Shiar* are concerned about protecting. Any suspicious individuals (especially non-Romulans) on Agurtha are likely to be taken in and questioned by the *Tal Shiar* to ensure that they are not Federation spies.

Gaius

Class: M

System Data: One moon, currently occupied by a Taurhai monitoring station.

Gravity: 1.05 G

Year and Day: 322/26

Atmosphere: Oxygen-nitrogen at approximately Earth-normal pressure.

Hydrosphere: 55%

Climate: Seasons ranging from warm-temperate to cold and damp. Rainstorms common in the winter seasons, but snowfall is a rarity except in the polar regions.

Sapient Species: Romulans and Taurhai. No native sentient species. Native lifeforms limited to plants and lower animal life (insects and marine life).

Tech Level: Level Six, with some higher-level Taurhai technology.

Government: Dictatorship (Most Worthy Administrator and Guide of the Taurhai Unity)

Culture: Originally, Gaiusian culture was entirely Romulan, with a strong pioneering attitude: resolute, with a strong believe in *D'era* and the destiny of the Romulan people. The recent conquest of the planet by the Taurhai has led to an enforcement of Taurhai culture and beliefs on the population, many of whom have been influenced by the Taurhai philosophies. Presently there is a war for control of the planet's culture between the Romulan colonists and their Taurhai "guides," who seek to teach the Romulans proper, civilized ways so that Gaius can be shown to the rest of the Romulan Empire as an example of the benefits that the Unity has to offer its people.

Affiliation: In dispute. The Romulan Star Empire claims Gaius as a colony world. The Taurhai Unity claims it as a protectorate, pending full membership in the Unity. The matter of Gaius' affiliation is under discussion at the Paxar IV peace talks between the Taurhai and the Romulans.

Resources: Gaius has considerable untapped resources. The colony is fairly new, only a few years old, and has just begun to survey and assess the planet's resource potential. The Taurhai have encouraged the Romulans to



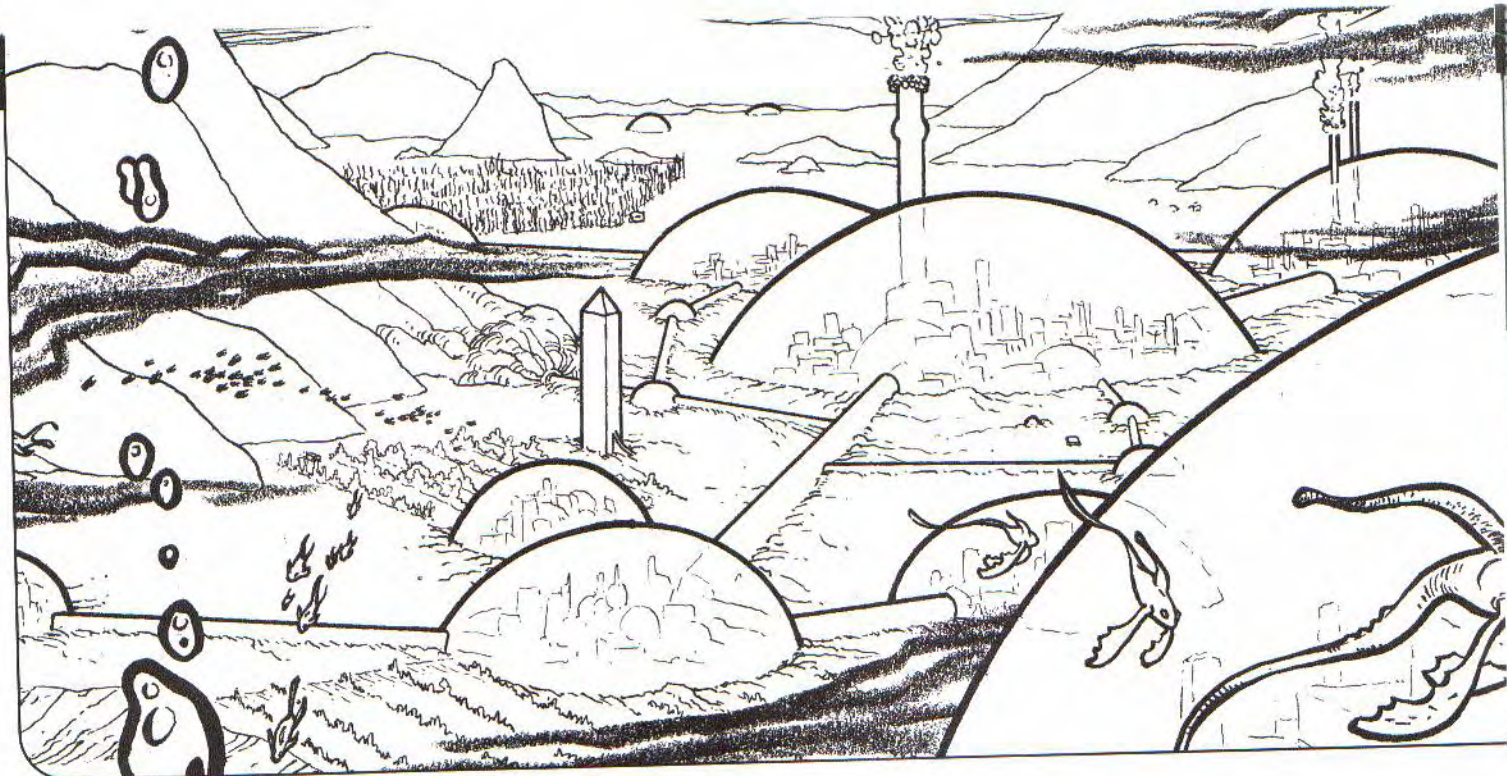

continue their work, with an eye toward more advanced means of gathering information and more proper ways of utilizing planetary resources for the benefit of all.

Places of Note: The Gaius Colony is the sole settlement on the planet's surface. It is under the administration of Romulans, who are overseen by the Taurhai. Those who show an acceptance of Taurhai ways and customs are given greater positions of authority in the colony and permitted to serve the Taurhai Unity by further educating their peers.

Ship Facilities: Gaius has limited ship facilities, for small shuttlecraft and similar vessels only. Traffic on and off the planet is carefully monitored by the Taurhai for the protection of the population from terrorists and to catch smugglers attempting to bring weapons and similar contraband to Gaius. The lunar station also scans for subspace signals indicative of transporters, tracing any unauthorized transporter activity to its source.

The Taurhai maintain a military presence near Gaius at all times, to protect the planet from Romulan attack. At least one star dragon remains in orbit or patrolling nearby space, and the Taurhai have established a monitoring station on the planet's sole moon that observes the whole Gaius system, particularly scanning for any indications of cloaked Romulan ships in the area.

Other Details: On the surface, life in Gaius Colony continues normally, but terrorist attacks against the Taurhai are becoming more and more commonplace. Taurhai authorities have responded with considerable patience and restraint. They wish to demonstrate to the citizens of Gaius that they are not barbarians who must meet force with force. Instead, Romulans loyal to the Taurhai are sent to infiltrate terrorist groups and expose them so they can be arrested and tried by the authorities.

The Romulan military and the *Tal Shiar* work to smuggle weapons and supplies to the terrorist groups fighting against the Taurhai. Many in the Romulan Senate feel this policy may backfire disastrously one day if the Taurhai discover it, leading to renewed hostilities between the Empire and the Unity, a battle the Empire is not assured of winning.

Hasdrubal

Class: M

System Data: No moons. Romulan ore-processing station located in high equatorial orbit.

Gravity: 1.2 G. Hasdrubal's high concentrations of metallic ores and heavy metallic core contribute to its high gravity.

Year and Day: 422/18

Atmosphere: Thin nitrogen-oxygen-carbon dioxide atmosphere; requires breathing equipment for long period of exposure (longer than about an hour), otherwise carbon-dioxide poisoning sets in.

Hydrosphere: 30% surface water, mostly found in small lakes. Highly active hydrosphere, with powerful planetary storms and regular rainfall.

Climate: Hot and damp, with rapid and frequent changes in climatic conditions. Violent storms and strong winds are common.

Sapient Species: None. Only Romulans and members of client species engaged in mining operations inhabit the planet.

Tech Level: Level Six (Romulan)

Government: Dictatorship (Romulan military governor)

Culture: Rough, frontier environment, populated by mining personnel. Much of the colony's population is made up of outcasts and malcontents from Romulan society, who chose Hasdrubal rather than face difficulties or criminal charges back home. The colony is relatively peaceful, though more violent than Romulan society. Romulan military personnel enforce order and a military governor oversees the colony, ensuring that it remains productive and law-abiding. The rest is not a concern and the colonists are allowed to handle their own internal affairs.



Affiliation: Romulan Empire

Resources: Hasdrubal holds rich deposits of talantium, a metal used in the construction of warbird hulls and other military construction projects. There are also rich deposits of aluminum, titanium, and various other metals and ores. The Romulans use advanced strip-mining techniques, literally tearing away and pulverizing the planet's crust to extract the needed materials. The ores are shot into orbit using mass-driver systems located near the planet's equator, aided by Hasdrubal's own rapid spin. An orbital mining station processes the ore and ships the refined metals out of the system.

Apart from its mineral resources, Hasdrubal contains little of value. Once the planet's resources are exhausted, it will be abandoned, leaving only a planetary slag heap behind.

Places of Note: Hasdrubal features some high mountains and deep valleys created by ancient seismic activity (the planet is seismically stable currently). These features are often the sites of mining operations, since they expose the largest veins of usable minerals nearest to the surface.

The planet is ruled from Hasdrubal City, a mid-sized settlement near the equator, which oversees the operation of the mass-driver facilities and the planet's sole spaceport.

Ship Facilities: Hasdrubal has only a single spaceport, near Hasdrubal City. The spaceport has facilities only for shuttles and cargo-loaders, not for larger ships. All interstellar ships dock at the mining station in orbit above the planet, never landing on the surface. Mass-driver systems are used to ship materials into orbit, where they are retrieved by the orbital facility for processing. The orbital station has facilities for the maintenance and refueling of starships, but very limited repair and construction resources.

Other Details: During the excavation of a new mine in the northern hemisphere, an unusual artifact was uncovered by Romulan miners. It is a metallic obelisk, some three meters high, covered in alien writing that does not match anything on record with the Romulan military. The obelisk appears to be made of refined talantium, using technology of at least Level Five or Six development. Its composition is resistant to sensor scans, possibly indicating a core or inner layer of a denser material. Its origin is a complete mystery. There are no other signs that Hasdrubal ever supported any kind of sentient life, and the miners estimate that the obelisk was buried by a volcanic eruption more than 250,000 years ago.

The governor has ordered the obelisk shipped to the mining station for evaluation, and has alerted the Romulan Star Navy of the discovery. The next cargo ship to dock at the station will take the obelisk and transport it to a Romulan scientific facility where it can be studied. Rumors already circulate among the miners of the colony that the obelisk is some kind of remnant of advanced alien technology, or that it indicates some kind of ill omen for the colony.

Hellaro Corva II

Class: F

System Data: No moons; one permanent space station in orbit.

Gravity: 0.8 G

Year and Day: 261/28

Atmosphere: None

Hydrosphere: None

Climate: None

Sapient Species: None

Tech Level: Level Six (Romulan)

Government: None

Culture: None

Affiliation: Romulan Star Empire

Resources: Hellaro Corva II has some mineral resources locked in the planet's crust, but its primary interest to the Romulans is scientific.

Places of Note: The southern equatorial plains of the planet hold ancient ruins that Romulan archaeologists believe belonged to the Iconian civilization. The ruins are buried beneath the remains of an ancient volcanic eruption, from the time when Hellaro Corva II was volcanically active. There is some speculation that the eruption was due to the gravitational stresses on the planet, or because of some Iconian technology (intentional or otherwise). The ruins appear to be those of a small city, colony, or settlement. The Romulans have only begun uncovering them.

Ship Facilities: The space station in orbit over Hellaro Corva II has facilities for starships to dock and offload supplies and personnel, but very limited repair and maintenance facilities.

Other Details: The Romulan Astrophysical Academy has a permanent space station located in orbit over Hellaro Corva II in order to study and measure the Eye of Corva, a black hole orbiting the main star of the system. The research involves a study of singularity phenomena, with an eye toward enhancing the performance of Romulan quantum singularity drives. The researchers on the station are also secretly studying the Iconian ruins on the planet below, and reporting their findings directly to the *Tal Shiar* and the Romulan military. The project is top secret and not even members of the Senate are aware of it as yet, although some are becoming suspicious. For more information on the Venturius Sector, see page 92 of "The Romulan Domain."

Justarus

Class: M

System Data: Three moons: one Class F, the other two Class D planetoids. The Class F moon, named Terek, is home to a small lunar mining colony that provides materials for Justarus and other nearby worlds.

Gravity: 1.08 G

Year and Day: 393/26

Atmosphere: Oxygen-nitrogen at slightly higher than Earth-normal pressure.

Hydrosphere: 85%; the water on Justarus has a greenish color due to the abundance of sea plants and traces of copper.

Climate: Temperate, but given to strong winds and powerful storms. A weather modification grid controls most of the excesses of Justaran weather, channeling them out to open water where they have little effect on settled areas.

Sapient Species: Romulans. No native sentient species, but many native forms of plant and animal life.

Tech Level: Level Six (Romulan)

Government: Oligarchy (Romulan planetary governor)

Culture: Romulan. Justarus is an old Romulan colony world with a long history, settled in the early days of the Empire. It has strong cultural ties with the Romulan homeworlds, and tends to follow the lead of Romulus when it comes to cultural mores and trends.

Affiliation: Romulan Star Empire

Resources: Justarus has only limited mineral resources, most of them hidden deep beneath its oceans, where they are harder to access. Most minerals are mined from its moon Terek instead. The planet's oceans contain rich biological material, however, and form the basis for an extensive aquaculture industry, which grows a wide variety of sea proteins and plants that are processed to make different types of foods. Many of the sea creatures of Justarus are considered delicacies in the Romulan Empire, such as fressenor caviar and Justaran shellfish. Justarus also has a healthy tourist industry among Romulan citizens who visit the planet for its thousands of kilometers of white beaches and many different aquatic activities.

Places of Note: Bratokka, the capital city, is located on the largest landmass, in the northern hemisphere. Justarus' landmasses are all islands, scattered across the surface of the planet. Bratokka is an old-style Romulan city, with graceful column and broad plazas cut from the native Justaran coral in beautiful shades of white, cream, pink, and gold. The city contains the University of Justarus, renowned for its many scientific programs, particularly in the life sciences.

The Korrin Archipelago is an equatorial collection of tiny islands and ancient coral reefs teeming with exotic marine life. It is a favorite place for tourists to visit and relax. Many hospitality centers dot the various islands, and small boats and pleasure craft carry people from one island to another, often no further than crossing the street.

The largest of Justarus' underwater cities is Vola T'nor, a sprawling metropolis of undersea pressure domes on the floor of the southern ocean reaches. The city has vast aquaculture farms, and also serves as a research center for exploration of the Justaran oceans and sea life.

Ship Facilities: Stations in orbit over Justarus provide docking and maintenance facilities for arriving ships. Repair facilities are limited, but capable of handling

most types of routine repair work, at least sufficiently to get a ship on its way to a better equipped facility.

Other Details: Justarus is the homeworld of Senator D'mora, rival of Senator Solos from Quatel (see page 105 for more information).

Paxar IV

Class: K

System Data: No moons; one large orbital facility (Paxar Station).

Gravity: 0.75 G

Year and Day: 287/18

Atmosphere: Carbon dioxide-nitrogen

Hydrosphere: 10%, locked into ice and atmospheric water vapor.

Climate: Frigid cold, with moderate winds, but very little atmospheric activity otherwise.

Sapient Species: None

Tech Level: Level Six (imported technology)

Government: None

Culture: None

Affiliation: None. Paxar IV is considered neutral territory between the Romulans and the Taurhai. Travel through the system is restricted; unauthorized ships are turned back by patrol vessels.

Resources: Paxar IV has some limited mineral resources, but little else of material value.

Places of Note: Paxar IV was once volcanically active. Although long since cooled and stabilized, the planet is still riddled with ancient lava vents and tunnels among its rock formations. These tunnels and caves are occasionally used for clandestine meetings by Romulans and Taurhai using life-support equipment.

Ship Facilities: None. Paxar Station has docking facilities for up to half a dozen ships at once, along with the necessary maintenance and repair facilities. The facilities are Romulan in design, and are best suited for handling Romulan vessels. Although Taurhai ships dock at the station, they are serviced only by Taurhai crews using what limited facilities are available for the Romulan ships.

Other Details: Following the Battle of Chi'tan and the cease-fire in the Romulan/Taurhai War, both sides chose a neutral world between their areas of space to conduct a peace conference. Paxar IV was suitable because of its location and because it was not claimed by either side of the conflict, having little to offer by way of colonization or resource potential.

The Romulans constructed a space station in orbit over the planet with limited Taurhai assistance. The station houses the peace negotiations and the various



delegates, ambassadors, and their aides, support staff, and security personnel. The station is off-limits to civilian traffic, and located so out of the way that few, if any, vessels pass through the system by chance. Both Romulan and Taurhai ships and personnel provide security for the station, and the Paxar system is considered neutral space for both parties.

Treaty negotiations between the two interstellar powers are slow and painstaking. Although both sides are currently not prepared for a new conflict, they both know that the negotiations are mainly to buy them time to rebuild their forces and come up with new ways to circumvent their opponent's advantages. This creates an atmosphere of paranoia and cynicism on board the station and in the peace talks. Although some of the delegates truly desire peace, most know that the Romulan and Taurhai philosophies cannot coexist peacefully. Sooner or later, there will be another war, and the Romulans, at least, want to be sure they can win.

In order to do so, they are working to learn everything they can about the Taurhai: their biology, their culture, their laws, and, most particularly, their technology. The station is filled with *Tal Shiar* spies and agents trying to gather information on the Taurhai. So far, most of their efforts have been frustrated by superior Taurhai technology. They haven't given up, however, and they're currently working on the possibility of inserting spies into the Taurhai delegation through connections on Gaius (see page 100).

For their part, the Taurhai truly want to show the Romulans the error of their ways. While the Romulans hurt the Taurhai with their attack on their homeworld, they have not stopped them nor weakened their faith in their way of life. The Taurhai are certain the Romulans will come around to their way of seeing things, sooner or later, willingly or not.

Pollar

Class: M

System Data: Pollar is the largest moon of the Class J Pollus VIII, a superjovian planet in orbit around Pollus, a G-type star.

Gravity: 0.8 G

Year and Day: Pollar orbits the superjovian in 94 days and rotates on its axis every 28 hours. Pollus VIII orbits its sun every 4,322 days (approximately 12 Earth years). This produces complex cycles of day and night on the moon, particularly during periods when it is eclipsed by the gas giant.

Atmosphere: Oxygen-nitrogen at approximately 1.2 times Earth normal pressure.

Hydrosphere: 50%; scattered among numerous lakes and rivers.

Climate: Dim, hot, and damp. Heat radiated from Pollus VIII makes the entire moon a tropical environment, even though light levels are less than half of Earth-normal daylight. Lifeforms are adapted to the low-light environment. Most plants have broad, dark foliage, and various forms of fungi are common.

Sapient Species: Pollarians. Small humanoids with large black eyes and overdeveloped ears, Pollarians have pale skin and no body hair from their warm, dim environment. Their eyesight is extremely sensitive, extending partially into the infrared portion of the spectrum. Bright visible light is extremely painful to them. Their hearing is likewise quite sensitive, leading the Pollarians to speak quietly by most humanoid standards.

Tech Level: Level Four, with some examples of higher-level technology acquired from interstellar trade (below).

Government: Largely feudal, with several large nation-states and many smaller ones. Wars and trading alliances are common.

Culture: Highly curious and mercantile. Strong, growing middle class and early industrial developments leading to the rise of capitalism and the rapid exploitation of resources. Trade and wealth are strong motivating factors; Pollarians measure success and happiness by an individual's wealth and material possessions. Feudal families are often owners of great wealth, but mercantilism is beginning to redistribute some wealth to the middle class.

Affiliation: Independent trading partners of the Breen

Resources: Pollar has large deposits of valuable minerals, including dilithium. The Pollarians have been unable to make full use of many of these resources, so they trade them to the Breen in exchange for more advanced technology and other useful items. Competition is fierce among the noble families and trading houses for the Breen's business but, thus far, the Breen prefer to favor the Langell Commonwealth, the largest and most prosperous Pollarian nation. With Breen assistance, the Commonwealth is rapidly expanding and exerting power over its neighbors.

Places of Note: Ovus-Fal, the capitol of the Langell Commonwealth, is the largest city on the moon. It is also the contact point between Pollarian and Breen traders. It is a sprawling cliff city, built along the walls of a vast, deep valley with many different levels and layers. Narrow bridges span the valley at various heights, allowing for movement from one side of the city to the other. The valley floor is largely given over to parkland and recreation, with a river and several small lakes.

Ship Facilities: Very limited. The Breen have established a landing field at the north end of the Ovus-Fal valley for cargo shuttles and similar craft. Most shipments and personnel are beamed to and from the surface. Pollarian technology is insufficient for anything but the most primitive repairs to Level Five or greater technology without extensive amounts of work.

Other Details: The Pollus system lies within the largely unexplored Tullus Sector of the Romulan Empire. Although it has not yet been discovered by the Romulans, the moon has been discovered by Breen traders, who have a strong interest in maintaining their monopoly on Pollarian dilithium and other mineral resources. To protect their interests, the Breen may attack Romulan ships coming into the area and would certainly arm or supply the Pollarians to fight off a Romulan invasion, if necessary (provided there was minimal risk to the Breen themselves).



Quatel

Class: M

System Data: Quatel has one moon, home to a Romulan mining and shipping facility.

Gravity: 1.2 G. Quatel has strong gravity due to the high concentrations of metals in its core.

Year and Day: 468/32

Atmosphere: Oxygen-nitrogen; slightly lower than Earth-normal pressure.

Hydrosphere: 60% surface water, mostly locked into massive glaciers and polar ice-caps.

Climate: Frigid and clear, with occasional fierce snow and ice storms.

Sapient Species: Quatellians (humanoid, with fatty subdermal tissue deposits providing protection from extreme cold), approximately 3 billion; Romulan, approximately 35 million.

Tech Level: Originally Level Two, currently Level Five-Level Six due to importation of Romulan technology and education.

Government: Oligarchy (Romulan planetary governor)

Culture: Highly industrious and eager to please, focused on work and the support of family.

Affiliation: Protectorate of the Romulan Star Empire

Resources: Extensive mineral, metal, and crystal resources. The planet is covered with mines and factories producing refined metal ores and metal goods, including titanium composites. There is also a thriving industry in cut and refined gemstones and locally crafted jewelry.

Places of Note: Qua'no'los ("the Stone Heart") is the planet's largest and most spectacular mountain range, featuring glacially sculpted terrain, high cliffs, and deep canyons. The region is filled with mines and factories, along with domed living facilities protected from the frozen climate. Nearly all travel is handled by shuttles and other aircraft, since the terrain is too rocky and treacherous for ground vehicles.

Ship Facilities: There are landing facilities for shuttles and small craft near all major population centers. Mass-driver systems are used to launch payloads of materials into low planetary orbit for recovery by transport ships. Orbital stations handle ship transfers and resupplying, coordinated from lunar command facilities. Limited ship repair and spacedock facilities in orbit.

Other Details: The Quatellians are a peaceful race and loyal clients of the Romulan Empire. They are heavy, broad humanoids with somewhat masklike features due to the fatty deposits under their skin, which allow them to handle exposure to the cold climate of their homeworld. Quatellians are hard workers with a strong desire to please. Their native dress is made up of animal fur parkas, pants, and mittens, but most Quatellians have adopted quasi-Romulan style clothing since their induction into the Empire.

They have completely abandoned their earlier, primitive culture in favor of Romulan values and ideas, save for a few minor cultural elements, such as the use of face-painting for decoration (originally part of a Quatellian spiritual and religious rite). The Quatellians credit the Romulans for raising their culture out of barbarism and giving them the opportunity to be productive members of a great empire.

Subera Penal Colony

Class: H

System Data: Three small moons. One holds an orbital security and monitoring station for the planet, which has three small interceptor craft for planetary defense.

Gravity: 1.08 G

Year and Day: 345/27

Atmosphere: Nitrogen-carbon dioxide at 0.8 Earth-normal pressure.

Hydrosphere: 10%, all locked into polar ice and water vapor.

Climate: Hot and dry, with strong winds and regular sandstorms that sweep across the surface. High levels of ionic radiation in the upper atmosphere prevent the use of transporters to and from the planet's surface. Powerful electrical discharges in the upper atmosphere are common.

Sapient Species: None

Tech Level: Level Six (Romulan)

Government: Military dictatorship (Romulan planetary governor)



Culture: Extremely limited. Prisoners are expected to obey all orders from the military governor and any Romulan personnel. Otherwise the planet is given over to anarchy.

Affiliation: Romulan Star Empire

Resources: None

Places of Note: The Subera facility is a large collection of pressure domes and structures on one of Subera's flat desert plains. It is a Romulan prison facility for the holding of criminals and political dissidents. The facility currently holds around 100,000 prisoners of various species and it is reputed to be escape-proof. The outside environment is unlivable without the use of a breathing apparatus, and the only way off the planet is by Romulan shuttle to the lunar monitoring base. Anyone attempting to leave the surface without authorization is shot down by Romulan interceptor ships.

Ship Facilities: The planet itself has facilities only for personnel shuttles, which ferry prisoners and personnel in from the lunar command facility. The command facility has administrative quarters and offices and more extensive docking facilities for larger ships, although transfers of personnel and equipment are still via shuttles or transporters (which function normally outside the planet's atmosphere).

Other Details: Subera is fairly typical of a successful Romulan penal colony. The prisoners are allowed considerable freedom within the limits of the pressure domes. Apart from obeying the guards (who are rarely seen), prisoners are largely left to fend for themselves. Packs of gangs are common, organized around strong leaders. The gangs enforce their own rules on the other prisoners and often extort food (the only valuable resource) from their fellows, as well. Occasionally, the Romulans select prisoners for use in medical or scientific experiments, as well as conduct behavioral studies of prison society.

Sentences to Subera are nearly always for life, and prisoners sent to the planet are generally never heard from again. The facility is often used by the *Tal Shiar* to make someone "disappear." It keeps a prisoner in the Subera facility for as long as he is useful, conducting lengthy interrogations to gather information. Prisoners who "belong" to the *Tal Shiar* are often given preferential treatment (for as long as it serves the *Tal Shiar's* interests to do so). When the *Tal Shiar* is finished, the prisoner is left to rot in the prison. Such former "favorites" rarely last long in the prison environment.

Sudeka III

Class: M

System Data: Two moons, both uninhabited.

Gravity: 1.1 G

Year and Day: 382/27.5

Atmosphere: Oxygen-nitrogen at slightly lower than Earth-normal pressure.

Hydrosphere: 70%, contained in three large oceans and several smaller seas and lakes.

Climate: Temperate, with moderate rainfall and mild climatic changes.

Sapient Species: None. Lower forms of animal and plant life are abundant, including high-order mammals, reptiles, and insects. Large forests cover the major landmasses.

Tech Level: Level Five-Six

Government: Romulan colonial governor

Culture: Pioneering and occasionally harsh. Although the Romulan colonists subscribe to most of the same cultural ideals as other Romulans, the needs and requirements of life on a new planet lead them to be stricter and more reserved than other Romulans. Laws are firmly enforced, since unlawful acts can endanger the survival of the colony as a whole. The success and survival of the colony is considered paramount, and the governor has broad powers in enforcing the law. Cultural pursuits are limited, while construction, exploration, and development activities are emphasized.

Affiliation: Romulan colony world. Currently not represented in the Romulan Senate until it achieves self-sufficiency and independent status.

Resources: Extensive plant and animal resources, along with various mineral resources. Resources currently devoted solely to the construction and maintenance of the colony.

Places of Note: The Valley of Jandara is a deep, wide canyon cut across the northern continent of Sudeka, most likely by some kind of erosion pattern over the course of millions of years. The valley is lush with various kinds of plant life, and layered with different ecosystems that stretch from the valley floor, two kilometers deep in some places, up along the sloping sides to the top. The wide Jandara River flows along the bottom of the valley, while *j'akta*, flying reptiles similar to smaller versions of Earth pterosaurs, nest in the higher elevations.

Ship Facilities: Limited. A bare-bones landing facility exists near the colony, suitable for shuttles and small cargo vessels. Most equipment and supplies are beamed down to the colony from orbiting vessels. The heavy foliage over the rest of the undeveloped land makes ship landings difficult.

Other Details: Sudeka is a new Romulan colony world, established a few years ago. The planet is ideal for colonization: temperate climate, no sentient life, but abundant plant and animal life. The only potential problem is the fact that it lies close to Breen space, and there have been reports of Breen pirates raiding ships in the area. No Romulan ships have been attacked yet, but one Ferengi merchant ship contracted to deliver supplies to the colony was attacked and looted, making other merchants reluctant to travel to the new colony. The Romulan Star Navy has plans to dispatch a ship into the area to search for the pirates and put a stop to the raiding. Until that happens, the colony itself may have to do without some various supplies, like replication equipment and medical supplies. The colonists are doing their best to get food and medicines from native materials in the meanwhile.

Tareus Shipyards

Class: J

System Data: Twelve moons, all F, G, or K Class. Six of the moons hold Romulan facilities for ship construction and repair, along with mining facilities. Several orbital stations are placed at points around Tareus to handle repairs, construction, materials transfer, and other tasks.

Gravity: 3.2 G. Most of the system's moons have gravities ranging from 0.4 G to 0.8 G. Artificial gravity is utilized within ground stations and on board ships. Microgravity is common within orbital factories, to allow for the manufacture of certain alloys and parts.

Year and Day: 4,161/18

Atmosphere: High concentrations of hydrogen, methane, chlorine, and other gases at five times Earth-normal pressure. Moons have limited or trace atmospheres for the most part.

Hydrosphere: None

Climate: Cyclonic storms and high winds are common.

Sapient Species: None

Tech Level: Level Six (Romulan)

Government: Military oligarchy (Romulan Star Navy)

Culture: Romulan military

Affiliation: Romulan Star Empire

Resources: The moons of Tareus contain substantial amounts of metals and mineral resources (including *talantium* deposits, which are nearly exhausted), along with hydrogen gas. Mining operations strip usable materials from the moons and send them to the shipyards for use in construction and maintenance. Regular shipments of outside materials are ferried in to the system using cloaked cargo ships, to keep the location of the shipyards secret.

Places of Note: Tareus IV, the largest moon, holds the central shipbuilding and administrative facility for the system. The moon has a trace nitrogen-carbon dioxide atmosphere.

Ship Facilities: Extensive. The Tareus system holds the prime shipyards for the Romulan Star Navy, constructing all classes of ships used by the Navy and in charge of the development and testing of new prototypes. The shipyards have repair facilities for up to twenty starships at once, and they are generally in the process of building at least four new ships at any given time. Most of the repair facilities are located in orbit around the gas giant, in stationary orbits that make them accessible to the lunar facilities, which handle administration, resources, and most of the design and development work.

Other Details: The location of the Tareus Shipyards is considered a state secret by the Romulan Empire. The *Tal Shiar* works hard to keep the location of the shipyards from falling into enemy hands. The Federation, the

Klingon Empire, and several other stellar powers would very much like to know the location of Tareus.

Thus far, the vigilance of the *Tal Shiar* has kept that information secret, but only because the tightest and strictest security measures are observed at the site. All ships traveling to Tareus must do so under cloak, even though they are in Romulan space. Ships cleared to travel to and from the system are thoroughly checked and cleared by the *Tal Shiar*, and regular random searches are required as part of the security protocol. Unidentified ships entering the system are destroyed without warning.

The Tareus Shipyards are currently working on new ship designs to incorporate improvements developed during the war with the Taurhai, particularly new sensor and cloaking technologies. One of the lunar facilities is devoted entirely to the development of new quantum singularity propulsion and power technologies, isolated from the rest of the facility in case of accidents. The facility is currently attempting to unravel the secrets of the Taurhai subspace funnel technology, but with very little success, since no working examples of the technology are available.

Tegedaar

Class: M

System Data: Tegedaar has two moons, one medium-sized and the other a small, rocky planetoid. There is a Romulan spacedock facility located on the larger moon.

Gravity: .93 G

Year and Day: 380/23

Atmosphere: Oxygen-nitrogen, with Earth-normal pressure.

Hydrosphere: 65% surface water in several large oceans; many seas and lakes.

Climate: Temperate, with frequent rainfall and mild seasonal variations.

Sapient Species: Tarquin (humanoid, gray skin, enlarged foreheads, golden eyes, native empathic ability), approximately 2 billion; Romulan, approximately 5 million.

Tech Level: Native technology originally Level Three. Currently in possession of some Level Six Romulan technology.

Government: Originally democratic. Currently military oligarchy under the Romulan Empire.

Culture: Peaceful philosophical culture focused on art and development of the spirit. Highly empathic and accepting of outsiders.

Affiliation: Protectorate of the Romulan Star Empire.

Resources: Plant and mineral resources, artworks (particularly fine pottery and ceramics).

Places of Note: Ges-Tennara, the capital city, is famed for its architecture and artwork. It is home to more than



a million Tarquin and is also the seat of the Romulan military government on Tegedaar.

The Tarquin Temple of Contemplation, in the nearby Voltin Mountains, is a famed site for Tarquin spiritual seekers, where they develop their empathic abilities. It is said that the great spiritual masters of the past achieved complete empathy with all living things, a kind of oneness with the universe. Romulan authorities believe the temple may be a haven for members of the Tarquin Underground.

Ship Facilities: Landing areas near major cities for Romulan ships. Orbital spacedock facility for repair and maintenance of Romulan military vessels only.

Other Details: The native population, the Tarquin, are under the rule of the Romulan Empire, which conquered their world several decades ago. Some Tarquin are given to passive resistance of the Romulan occupation, and a small underground has formed, made up of Tarquin who are willing to put aside their race's traditional abhorrence of violence in order to drive the Romulans off Tegedaar.

Tigelis VII

Class: M

System Data: Two small moons and a faint ring, visible from the planet's surface at night as a shimmering silvery path across the sky. The Ring of Tigelis is considered one of the great natural wonders of the Romulan Empire.

Gravity: 1.1 G

Year and Day: 386/28

Atmosphere: Oxygen-nitrogen at slightly higher than Earth-normal pressure.

Hydrosphere: 65%, found mainly in three major oceans.

Climate: Temperate, with mild weather patterns and regular rainfall. A slight ionic charge in the atmosphere gives most of Tigelis a feel similar to that of Earth following a thunderstorm. Many Romulans consider the planet's atmosphere and climate rejuvenating.

Sapient Species: Romulans. No native sentient species, but many native forms of plant and animal life.

Tech Level: Level Six (Romulan)

Government: Oligarchy (Romulan planetary governor)

Culture: Romulan. Tigelis is an old Romulan colony world, so the inhabitants are strongly influenced by the cultural mores and trends of the Romulans core worlds. Tigelis itself often helps to set trends in fashion, cuisine, and the arts. Most of the inhabitants are staunch supporters of the ideals of *D'era* and Romulan life. There is still a pioneer spirit among the people of Tigelis VII, a can-do attitude that gives them a reputation as innovative and hard working.

Affiliation: Romulan Star Empire

Resources: Tigelis has many different mineral and biological resources, particularly the rich ecosystem of its arboreal forests, which yield volumes of new biological research each year. The planet has a large artistic community, known for the cleverness of its crafts, poetry, and performance art (especially plays based on some of the classical Romulan epics, like *The Trials of Tellus*). Tigelis also hosts a thriving tourist industry. Hundreds of thousands of Romulans travel to the planet to take advantage of its spectacular natural beauty and the outdoor activities and to enjoy its culture and atmosphere.

Places of Note: Ronikar, the capital city, is a shining example of Romulan architecture, with buildings and plazas to rival those on Romulus itself. Statues and sculptures are quite common, and the tree-lined streets are wide and filled with pedestrian traffic. The city is located on the shore of the Arex Sea, kept cool by constant sea breezes and offering spectacular sunrises and various forms of aquatic recreation.

The nearby Jolannian Mountains provide a scenic backdrop, as well as providing opportunities to ride *garthan*, native mounts which look like large mountain lions with mottled gray fur, quite sure-footed in the rocky mountain terrain.

Ship Facilities: Ronikar has a spaceport for planetary vessels, and orbital facilities exist for the docking and maintenance of starships. Repair facilities are limited, but more than capable of handling minor repairs and system upgrades.

Other Details: The scenic and peaceful world of Tigelis, along with the whole of the Tiber Sector, has recently suffered a disastrous outbreak of Phyrox Plague. The shining streets of Ronikar are cleared of all but essential military personnel. Citizens cower in their homes hoping to protect themselves, or else take to the streets in riots to protest and demand action from the government. All travel to and from Tigelis VII is forbidden, crippling the planet's once prosperous tourist industry and trapping many tourists on the planet, unable to return home. The pressure on Tigelis builds to a fever pitch, and more violence will likely erupt unless something is done soon. Present Romulan medical efforts are simply not sufficient.

Senator Jollen Merek of Tigelis VII has proposed the radical idea of seeking Federation aid to end the plague on his homeworld, but the Romulan Senate rejected his plan. Senator Merek may take it into his own hands to end the plague (see page 42 of *Romulan Characters* for more information).

ROMULUS



A verdant world of majestic vistas, sweeping plains, towering mountains, and seas of blue and purple, Romulus is the heart and soul of the Romulan Star Empire. Known to citizens of the Federation simply as the capital of the Empire, to the Romulans Romulus holds a much greater importance: It is their native land, the world they invariably think of when thoughts turn to home, family, and peace. Even the most battle-hardened Romulan warriors get a nostalgic look in their eyes when they think of Romulus, the homeland they fight to protect and whose glory they ever strive to enhance.

The rich and detailed tapestry of life on Romulus cannot be described in thorough detail, of course; the Romulans themselves have written thousands of books on the subject, and more always remains to be discovered about their world. This chapter instead concentrates on the broad perspective, the high points, the references that will intrigue and inspire. The precise details needed for an in-depth character background or a scenario are left to the fertile imaginations of players and Narrators.

The Planet

Romulus is a Class M world approximately 14,000 kilometers in diameter at its equator, making it slightly larger than most Class M worlds (such as Earth). Its atmosphere contains the oxygen-nitrogen mix typical of such worlds, without major concentrations of other gases or even, at this stage in its history, much in the way of greenhouse gases or other pollutants. The inhabitants of other worlds in the Empire, particularly Remus, envy Romulus' fresh, clear air.

In fact, Romulus could be considered a model Class M world. Unlike worlds on the fringes of the Class M category, it has a wide variety of ecologies and environments. As a traveler moves from the ice-covered polar regions toward the equator, he passes through northern temperate, temperate, subtropical, and finally tropical regions, each containing its own distinctive flora and fauna. In some regions geographic and atmospheric conditions have conspired delightfully to create pockets of unusual climate or wildlife, further enhancing Romulus' biodiversity.

The planet's climate mirrors this environmental variation. Although it has an average temperature of approximately 21° Celsius, the actual temperature differs wildly based upon the location and the season; Romulus has its beautiful, sunny days, swelteringly hot days, and bitter, gray winter days. It also has generous rainfall—an average of over 120 centimeters, with some tropical regions getting much more. Thunderstorms occur frequently during the summer months, and in the flatter regions of the temperate zone, tornadoes can also develop during that time. Due to the fact that it has only one large ocean, Romulus experiences few hurricanes or typhoons (*kel'thrar*, in the Romulan tongue); only the eastern coast of Brel'kar and western coasts of Umrika and Valcaria suffer from them. Sometimes one of these fierce storms squeezes through the Terelix Strait to devastate the islands of the Apnex Sea before it plays itself out.

CONTINENTS AND ISLANDS

Five continents—Brel'kar, Folloss, Novok, Valcaria, and Umrika—cover the face of Romulus. They range from Brel'kar, the largest, most ecologically diverse continent, and the home of the majority of the Romulans on the planet, to Folloss, a small continent rising out of the sea between Novok, Umrika, and Valcaria with a mostly temperate climate. Brel'kar includes the



KAUR'EL TENNAHREX

Type: Strategic (Romulus' defense platform)

Location: In orbit around the planet Romulus

Commissioning Date: Original construction in late 22nd century; expanded and upgraded in 23rd century and again in mid-24th century.

HULL CHARACTERISTICS

Size/Structure: 8/4 kilometers-long defense platform built along a latitudinal axis, with various weapons pods, control centers, and other structures scattered along its length.

Resistance: 10

Structural Points: 600

Docking: 50 docking ports capable of holding ships of *D'deridex*-class size or smaller; 200 docking ports for smaller ships.

PERSONNEL CHARACTERISTICS

Crew/Inhabitants/Capacity: 4,325/2,770/27,500
[9 Pwr/rnd]

Entertainment: 6 [18 Pwr/rnd]

SYSTEMS CHARACTERISTICS

Computers: 10 [10 Pwr/rnd]

Transporters: 40 personnel, 80 cargo [60 Pwr/rnd]

Tractor Beams: 35 tractor beam arrays are staggered along the ventral and dorsal surfaces of the station
[2 Pwr/rating/rnd]

Power: 800

SENSOR SYSTEMS

Long-range Sensors: +2/17 light years [6 Pwr/rnd]

Lateral Sensors: +2/1 light year [4 Pwr/rnd]

Sensors Skill: 5

Internal Security: 5

WEAPONS SYSTEMS

Type S Disruptor Cannons

Range: 10/30,000/100,000/300,000

Arc: All (720°)

Accuracy: 4/5/7/10

Damage: 30

Power: [30]

Plasma Torpedoes

Number: 20,000

Launchers: 50

Arc: All (720°)

Range: 15/300,000/1,000,000/3,000,000

Accuracy: 4/5/7/10

Damage: 20

Power: [15]

Weapons Skill: 5

DEFENSIVE SYSTEMS

Romulan Deflector Shield

Protection: 120/120/120/120

Power: [120]

Ships: 6 *D'deridex*-class warbirds, 24 smaller military vessels (complement varies from year to year, based on perceived need), 12 Romulan warp shuttles, 12 Romulan scout ships, 100 Work Bee-type craft

planet's highest point, Mount Al'kathel, in the Kae'raktar Mountain chain; the lowest point is the Valley of Fire in the Ar'hael Desert of southern Novok.

In addition to continents, islands have been generously sprinkled across Romulus' seas. According to the Grand Survey of the ancient Romulan explorer Lerodan, there are over 400 islands at least one kilometer square on Romulus, as well as hundreds of smaller islands. The largest concentrations of islands are the D'vrex Archipelago between southern Brel'kar and southern Novok, the Sath'har Archipelago in the eastern Apex Sea, and the wintry Uulmar Islands near the planet's arctic region.

SEAS

Romulus is a world of seas, rather than oceans. Only one body of water, located between the continents of Brel'kar, Umrika, and Valcaria, holds enough water to qualify as an ocean; the Romulans call it the Nelrek Ocean. The planet's largest animal, the Romulan green whale, lives in the Nelrek. Romulus' other major bodies of water are all seas. The most beloved of these, the Apex, separates Follross, Umrika, and Valcaria; Romulan poets have rhapsodized about its purplish waves and gentle breezes for centuries. Other seas include the Garenak Sea (between Novok and Umrika), the North Mendlanar Sea and South Mendlanar Sea (which girdle the planet's arctic and antarctic ice caps, respectively), the White Sea (between Follross and Novok; so called because of its often choppy waves), and the Havrelar Sea and Sea of Lerodan (both between Brel'kar and Novok).

In addition to its seas, Romulus also features two large bodies of fresh water, both located in Brel'kar: the Sea of Vrekess and the Sherelak Sea. Together these two gigantic lakes pour themselves out into the kilometers-wide Thal'Tharin River, which cuts through the northern half of Brel'kar. Many other lakes and rivers cover the landscape of the five continents, but none is as large as these.

MOONS AND SATELLITES

Two moons orbit Romulus. The Romulans named the nearest of them Pirek, meaning "the Leaper," since the geography of Pirek appears to the Romulan eye to display a leaping animal of some kind (most Romulans think of it as a predatory cat). Pirek often dominates the night sky over Romulus, obscuring the view of the stars. Superstitious Romulans regard the second moon, Elvring, as ominous; according to old tales, the position and shape of Elvring in the sky on the night of a Romulan's birth determines whether he will be lucky or unlucky in life (nights when Pirek eclipses Elvring are the luckiest of all, but an eclipse of Pirek by Elvring is the worst possible omen). Sharp-eyed Romulans can often see the dim shadow of their world's sister planet, Remus, in the sky as well.

Several artificial objects also orbit the Romulan homeworld—enormous communications satellites, orbital manufacturing facilities, and the like. The largest of these is *Kaur'el Tennahrex* ("the High Fortress"), the massive orbital defense platform which stands as Romulus' final line of defense against invaders. It controls a vast network of smaller defense satellites scattered around the planet and the space near Romulus. (This network resembles the Mars Defense Perimeter near Earth, but is located closer to the planet it defends.) Non-Romulans are never allowed on *Kaur'el Tennahrex*.

Smaller than High Fortress, but no less important, is the Veldras Orbital Power Facility, a massive power station which produces energy that it beams down to Romulus to power the planet's cities and homes. It contains a network of several linked quantum singularities which it taps for power in much the same way as a Romulan starship uses a quantum singularity drive to fuel itself.

THE FIRST ARRIVALS

When the earliest Romulans reached Romulus, and were told their diaspora was over at long last, they were astonished. Many had expected a world similar to their former homeland of Vulcan: hot, dry, dusty, and with thin air. Their new home was a far cry from Vulcan. It was lush, verdant, and networked by rivers, lakes, and seas. It had very cold areas and

very humid areas, neither of which the proto-Romulans were accustomed to. The immigrants christened their world Rom'laas, after the home of *Ket-cheleb*, the Vulcan god of war.

In short, while the new "Rom'laans" recognized Romulus as their new home, and as a paradise, it took some getting used to. Their people had to adapt to the new climate and learn how to practice agriculture in it. Sailing, fishing, and other waterborne activities became a much greater aspect of their lives and their economy than had ever been the case on Vulcan. Fortunately, their experiences during the diaspora had prepared them for such difficulties, and they rose to the challenge of exploring and taming their new world. Thousands of years later, Romulus, now more of a paradise than ever for the Romulans, is a silent witness to their dedication and skill.

Brel'kar

Of Romulus' five continents, Brel'kar is the largest. It occupies more than half of the planet's eastern hemisphere. It looms even larger in Romulan social and political life, because the capitol, Val'danadex Trel, is located here, where the earliest Romulans first landed on their new homeworld; furthermore, more Romulans live on Brel'kar than on any other continent. Despite the relatively high population and presence of many cities, much of the continent remains pleasantly wild, offering the Romulans many opportunities for recreation.

Geographically, Brel'kar can be broken down into six distinct regions: the northern tundra and mountains; the Tallesreld, the region around the two vast inland seas; the western coastal plains, where Val'danadex Trel and many other cities are located; the central plains; the east-central mountain/hill region; and the southern woodlands.

THE NORTHERN REGION

The northernmost parts of Brel'kar reach nearly to Romulus' arctic circle, making this region frigid and inhospitable—especially in the winter, when the nights last for many days (though several weeks of constant daylight in the summer provide a balance). Even in the summertime, the winds coming down off the polar ice cap carry a bitter chill; the Romulans call them *ath'rel'ithar*, the "winds of frozen tears." As they race across the often treeless tundras, the winds finally collide with the southernmost boundary of this region, the majestic T'aresh Mountains, which stretch more than halfway across the continent.

The mountains funnel the winds upward, where they meet masses of warmer air crossing the mountains from the south. The result: frequent thunderstorms in the summer and heavy snows in the winter. It often seems to the Romulans who live in this region—who are known as the *T'areshi*—that the land is a frozen glacier half the year, and cold swamp the other half! They build houses with an unusual architectural style which combines curved roofs (to resist heavy snow and ice accumulation) with construction on pilings raised about half a meter off the ground (to prevent flooding damage in the summertime).

The *T'areshi* are a hardy group of Romulans who enjoy pitting themselves against the elements. While most Romulans prefer to avoid extremely cold weather, the *T'areshi* almost seem to embrace it. An energetic

ROMULUS

Planet Name: Romulus (Ket-cheleb III)

Class: M

System Data: Romulus has two moons, Pirek and Elvring. Romulus is the third of ten planets orbiting the Romulan sun, Ket-cheleb. Remus (Ket-cheleb IV) is also Class M; the inner two planets are Class D and F, respectively; the outer six planets consist of Class G and J worlds. An asteroid belt which the Romulans mine exists between Ket-cheleb VI and VII.

Gravity: 1.0 G

Year and Day: 370.125/25

Atmosphere: Oxygen-nitrogen, with Earth-normal pressure

Hydrosphere: Approximately 69% of Romulus' surface is covered with water.

Climate: Standard Class M climate, ranging from arctic to tropical with normal seasonal variations

Sapient Species: Romulans (3.5 billion)

Tech Level: Six

Government: Republic

Culture: Often perceived as a militaristic, honor-bound culture, Romulan civilization actually exhibits a wide range of cultures, behaviors, and customs.

Affiliation: Romulan Star Empire (ruler)

Resources: Romulus once possessed extensive natural resources. Many of those have been exploited in the past two millennia, and the remaining resources are either protected or carefully managed.

Places of Note: Val'danadex Trel (capital city), Valley of Chula, Firefalls of Gal'Gathong, Apnex Sea, Jeweled Forest of Ath'reshaar

Ship Facilities: Kaur'el Tennahrex (orbital military defense platform), Mirek Shipyards and spaceport, three lesser facilities scattered throughout the system

Other Details: See text.

people, full of life and eager for challenges, they participate in sports and other outdoor activities regardless of the fact that the thermometer shows that it's twenty degrees below zero outside (wind-burn gives many of them a characteristic "green-cheeked" look). They laugh at outsiders who are unwilling to brave the elements with them, but greet anyone who can keep up with them with an open-hearted honesty and friendliness which would shock Starfleet officers who think of all Romulans as soulless *Tal Shiar* operatives in training.

Although geographically and culturally one united region, the northern plains are divided into five provinces for political purposes: Allorak, Chetris, Daal'Gareth, Mendrik, and Rel'enak. The senators from these provinces usually present a united front on questions of imperial or planetary import, but on a more local level the provinces like to squabble among themselves. Few real disagreements or disputes arise; the political quarreling amounts to nothing more than a form of good-natured intraregional rivalry. Similarly, the provinces like to pit themselves against each other in



RA'TAR

Type: Chasing hunter (bird of prey)

Size: An average *ra'tar* is about .65 meters long from beak to tail, and has a wingspan of 2 meters or more.

Form: Eaglelike body with a hooked bluish-colored beak and sharp yellow talons. The plumage is black on top, shading to orange or yellow-orange on the underside and around the head. The eyes are yellow.

Attributes: Fitness 3 (Strength -4), Coordination 4, Instinct 3, Presence 3

Base Movement: Walk 1, Fly 30

Resistance: 1

Special Abilities/Unusual Skills: Dive (*ra'tar* must make a Coordination Test against Difficulty 6 to hit target with talons while diving past it; if successful, talons do 4 points of damage instead of their usual 2)

Weapons: Talons (Difficulty 6, do 2 points of damage); Beak (Difficulty 8; does 1 point of damage)

Description/Notes: The *ra'tar* is a majestic bird of prey which inhabits the Kae'raktar and T'aresh Mountains. In its flight across the cloudy skies of Romulus, poets have seen in it a symbol for the Romulan Star Empire itself, and it has come to embody the Endless Sky in countless poems, songs, and paintings. This is the bird stylized on Romulan vessels and emulated in starship designs, and the symbol of the Romulan Empire. Even today, Romulans refer to their main war vessels as "birds of prey" or "warbirds." In centuries past, Romulans of high social station kept *ra'tar* for falconry; a few still do so today.

sporting matches, game tournaments, and other forms of competition. If nothing else, a good game of *yelbrek* (the so-called "Romulan chess") helps to pass the long and windy winter nights.

DAAL'GARETH AND VENDRAS

Daal'Gareth tends to be the most influential province in this region, for it contains the largest city, Vendras, and thus the greatest number of people. Located in the southern part of the region and bordering the Nelrek Ocean, Daal'Gareth is the only province in the region which has a long enough growing season to produce any of its own food. The other regions must rely wholly on replicated food or food brought in from other parts of the world. Daal'Gareth also has a large fishing and whaling industry; many of its towns and villages were founded hundreds of years ago by the crews of whaling vessels. Relics from that time of adventure on the seas, many of them quite valuable, may be viewed at the Maritime Museum in the town of Nareq'mor.

Vendras itself is but the largest of these former whaling towns, with a modern-day population in excess of one million. While parts of it have been preserved as historical landmarks, and even today exude a quaint sort of "old world" charm which attracts visitors, most of the city is highly modernized. With whaling and fishing no longer a dominant part of the economy, Vendras turned to other industries to sustain its growth. Foremost among these is finance; Vendras has become one of the centers of the Romulan Star Empire's monetary system. Many financial firms own buildings in the downtown region whose plastiglass towers mirror the iciness of the T'aresh Mountains to the west. Other mainstays of the local economy are several manufacturing facilities owned by the Romulan military (and closely watched by the *Tal Shiar*) and the remaining whaling industry.

THE TALLECRELD

Tallesreld is the Romulan name for the region surrounding the two inland seas, Vrekess and Sherelak, and the Thal'Tharin River. The climate here ranges from northern temperate to temperate. The areas near the southern edge of the T'aresh Mountains can become quite cold indeed, but most of the rest of the region remains warmer because of the large bodies of water. That much water also means significant amounts of rain, making the Tallesreld well suited to agriculture. Many fields covered with golden *vareet*, the wheatlike grain with which the Romulans brew their famous ale, can be found in the region, though not as many as can be found in regions to the south.

Tremendous swaths of forest cover most of the land not devoted to farming or urban areas. Some of the largest trees in the world fill these forests, especially the parts near the T'aresh Mountains which receive more rain. In fact, in places the trees grow so huge that they block out the sunlight, killing smaller plants and making the forests the perfect place for a hike. Only the occasional shaft of sunlight breaks the constant twilight of the forest floor to guide the hiker on his way. Here and there streams and rivers come crashing down out of the mountains to cut broad-stepped walled valleys through the forest, presenting fabulous vistas to those who reach the right vantage points.

The lakes and the river, not *vareet* fields or forests, form the true lifeblood of the Tallesreld, however. The lake tides dictate the pace of life in much of the region, and those who live on the rushing, thundering waters of the Thal'Tharin cannot help but craft their lifestyles around it. Fully two thirds of the people in this region live within a half-day's journey by ground vehicle from either the lakes or the river. The people earn a living fishing and trawling the lakes for shellfish, providing food for those without a replicator.

THE WESTERN COASTAL PLAINS

South of the Thal'Tharin River and Sherelak Sea the landscape quickly turns to rolling plains covered with farmland or light woods, broken here and there by ranges of hills. This region, along with the central plains, forms the "breadbasket of Romulus"—the region which produces over a third of the planet's naturally grown food. One can fly over the plains for hours and see little more than rolling golden fields of *vareet* swaying gently in the breeze.

The wooded hill areas, not suited for agriculture, house the breweries of many of Romulus' famed ale-brewers. Drawing water from local springs, and the essence of the local *vareet* and several other plants (each brewery's recipe, of course, remains a secret), they brew potent Romulan ale which they trade all over the galaxy (even in the black markets of the Federation, where it has been

outlawed). Romulan connoisseurs debate long and loud about which brew tastes the best. Occasionally, in place of a brewery, one finds a bakery instead; in some circles Romulan breads and pastries are as well regarded as Romulan ale.

VAL'DANADEX TREL

The western plains are the most heavily settled region of Brel'kar, largely because the world's capital, Val'danadex Trel, is located here. Built on a plain abutting the coast and bordered by hills on the east, Val'danadex Trel attracts everyone from government employees to military officials, from *Tal Shiar* agents to the dilettantes of the Romulan noble families, to ordinary folk who want to experience the thrills of the grandest city in the Romulan Star Empire. Over twenty million Romulans call the city and its satellite communities home.

Originally just a village springing up where the first Romulan settlers landed, Val'danadex Trel was rebuilt as a more planned and structured community over a thousand years ago, that it might better suit the Romulan sense of organization, efficiency, and Imperial grandeur. Many of the city's most magnificent buildings date from that time.

To walk the streets of Val'danadex Trel is to experience a sense of wonder and magnificence. Large buildings, constructed in an ornate Imperial style and often topped by majestic towers, dominate the main thoroughfares. On the less traveled roads, the buildings become smaller, with a more personal and comfortable feel, but nevertheless they retain a certain ornate quality which tells all citizens they are in a city of power and wealth.

The Boulevard of Heroes, so large it can be seen from space, runs from the shores of the Havrelar Sea to the city's center. Monuments and statues honoring the greatest Romulans of history line its grassy median. The enormous statue of Emperor Salangen at Setalep IV, the Laneshra Monument, and the Mausoleum of Reldek the Great, among others, can all be found here. Shops both elegant and quaint fill both sides of the street, and the broad sidewalks always bustle with people.

The Boulevard terminates near the middle of the city at the Plaza of the Endless Sky, an open area more than two square kilometers wide and broad. The center of Romulan political life, and of much of the city's social life as well, the Plaza hosts many events and festivals. On most days thousands of Romulans come here simply to enjoy the sunshine and fresh air. Other days they might attend a military parade, a speech by the Praetor, or some other major civic event.

The Romulan Senate, an enormous circular building whose shape every Romulan recognizes, occupies one side of the Plaza. The front steps leading into the building rise over a hundred feet; in the middle of the staircase stands a colossal statue of the first Romulan emperor, Valkis, his left hand stretched out benevolently to shelter his people from all threats. As the senators pass into the building each day to conduct the business of the Empire, they must pass beneath the statue and be reminded of the honor and ideals which it represents.

The Praetor's Palace, formerly the Emperor's Palace, fills the other side of the Plaza. The Praetor resides here, and performs most of his governmental functions here as well. The Praetorian Guard, a group of elite troops culled from the Romulan military, stand vigilantly at every entrance and chokepoint to protect the ruler of the

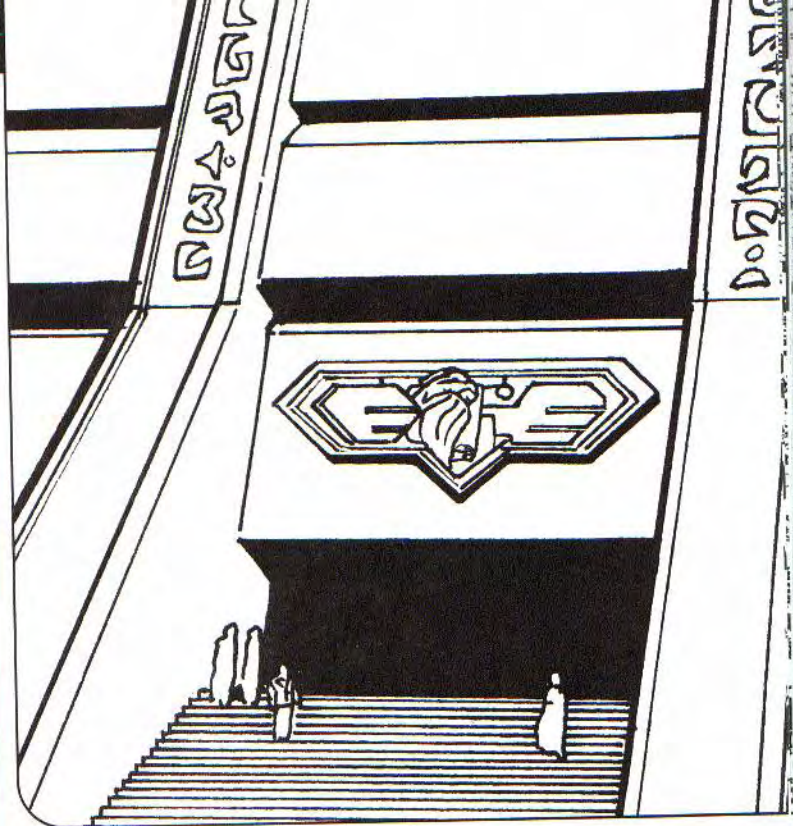

Empire. The palace, a compound rather than a single building, is a small city unto itself. It contains not only offices and apartments but gardens, recreation facilities, and many other accommodations fit for the glorious Praetor.

Other than these two, the most important building in the city undoubtedly is the Citadel Var'Theldun, headquarters of the dreaded *Tal Shiar*. So fearful of this building are most Romulans that many of them will not even let its shadow touch them, believing that even so ephemeral a contact means they will end up there for good. Traitors to the Empire who pass through Var'Theldun's doors for interrogation are never seen on the streets of Val'danadex Trel again; at best, they can hope to live out the remainder of their pitiable lives in some far-flung Romulan penal colony.

Not all parts of the capital are as awe-inspiring as these buildings, however. The so-called Old City houses the poorest and most wretched of the city's citizens. Here the buildings are smaller, lacking the grandeur of the finer quarters of the city, and the streets seem narrow and cramped. Sometimes, the crush of people becomes almost oppressive. Yet even here, the streets are clean and the inhabitants appear relaxed and mildly friendly. The Old City has some attractions, among them the largest open-air market in the city; citizens often come to shop for fresh, nonreplicated foods and other items. The *Tal Shiar* keep the streets of the Old City safe, and crime is unknown.

THE EASTERN HILLS AND KAE'RAKTAR MOUNTAINS

The Kae'raktar Mountains and the foothills surrounding them fill the eastern central part of Brel'kar; only a small strip of flat land exists between the hills and the ocean. Although the planet's equator runs through this region, the higher elevations created by the mountains cool the climate, making the area a very pleasant one in which to live. Many small forests are found here—coniferous forests higher up in the mountains, more jungle-like growths at lower elevations.

THE VALLEY OF CHULA

One of the most beloved areas on Romulus—the Valley of Chula—cuts right through the heart of the Kae'raktar Mountains. This vast, kilometers-long valley contains some of the most beautiful vistas and most exquisite climate on the entire planet. At the western pass into Chula, the Praetor's Summer Palace perches on a high hill overlooking the valley like a gold-winged eagle searching for prey. Similar to the palace in the city, the Summer Palace consists of many buildings grouped together to form a small administrative city. The Praetor resides here through the hot summer months, cooled by the Valley's breezes.

The Tor'ren River, whose boiling rapids have defied many a boater, bisects the valley; the nearby Fareldi Brewery, perhaps the greatest of the Romulan breweries, uses Tor'ren water to create its fabulous ales. A distinctive label shaped like a broad "Y" identifies Fareldi ale. Many resorts catering to the wealthy scions of Romulan society, including the renowned Chula House, can be found throughout the Valley.

THE CENTRAL PLAINS AND SOUTHERN WOODLANDS

Compared to the western coastal plains, the central plains and southern woodlands of Brel'kar seem bucolic, even desolate in places. Settlements here are relatively sparse, and few of them would qualify as cities. Instead, much of the land has been converted to large robotic farms which grow several staples of the Romulan diet (including *gresh*, a ricelike vegetable), or has been left wild. The southernmost part of the continent contains several swampy jungle areas which remain largely unexplored—though rumor has it that the *Tal Shiar* maintains a few facilities there.

Folloss

Sometimes known as "the Island Continent," Folloss, the smallest landmass on Romulus, has a reputation for being a cold, inhospitable place. While this perception

holds true for the northern portions of the continent, which approach the world's arctic circle, its southern subcontinent actually brushes the equator, making it a very hospitable place to live, the favorite of many Romulans.

Folloss rests between the North Mendlanar, White, and Apnex Seas. Poets have often written of its "windswept shores," and the "wave-tossed souls" of its people, but this continent holds much of interest which has nothing to do with the sea.

FAL'SERAS: THE NORTHERN REACHES

The part of Folloss which holds the strongest grasp on the Romulan mind is the Fal'seras—the far northern third of the continent (generally defined as all parts of Folloss north of the soaring Anverok Mountains). The first Romulans to reach Folloss landed here and created settlements centered around large community meeting halls, where folk would gather in winter to pass the long nights. Although not nearly as cold as the lands of the *T'areshi* in the far north of Brel'kar, the Fal'seras can become quite frigid when the arctic winds blow down from the bitter North Mendlanar Sea.

Situated inland, on the northern bank of the mighty Gend'eroth River, whose bitterly cold waters flow westward from springs high in the Anveroks, is the largest city of the Fal'seras, Namreshand. Home to over a million Romulans, Namreshand was founded over 1,500 years ago to serve as a trading post for the various small communities and families scattered across the face of the Fal'seras.

When the mineral *kavlarium* was discovered in the Anverok Mountains about a thousand years ago, Namreshand became more than just a commercial center. As the nearest major city to the mines, it developed into the natural focal point both for the *kavlarium* trade and for those whose manufacturing concerns relied on the mineral. Many major organizations established a business presence here to oversee their *kavlarium* mine holdings. Since *kavlarium* is an important element for the construction of parts for disruptors and related forms of military technology, Namreshand quickly developed

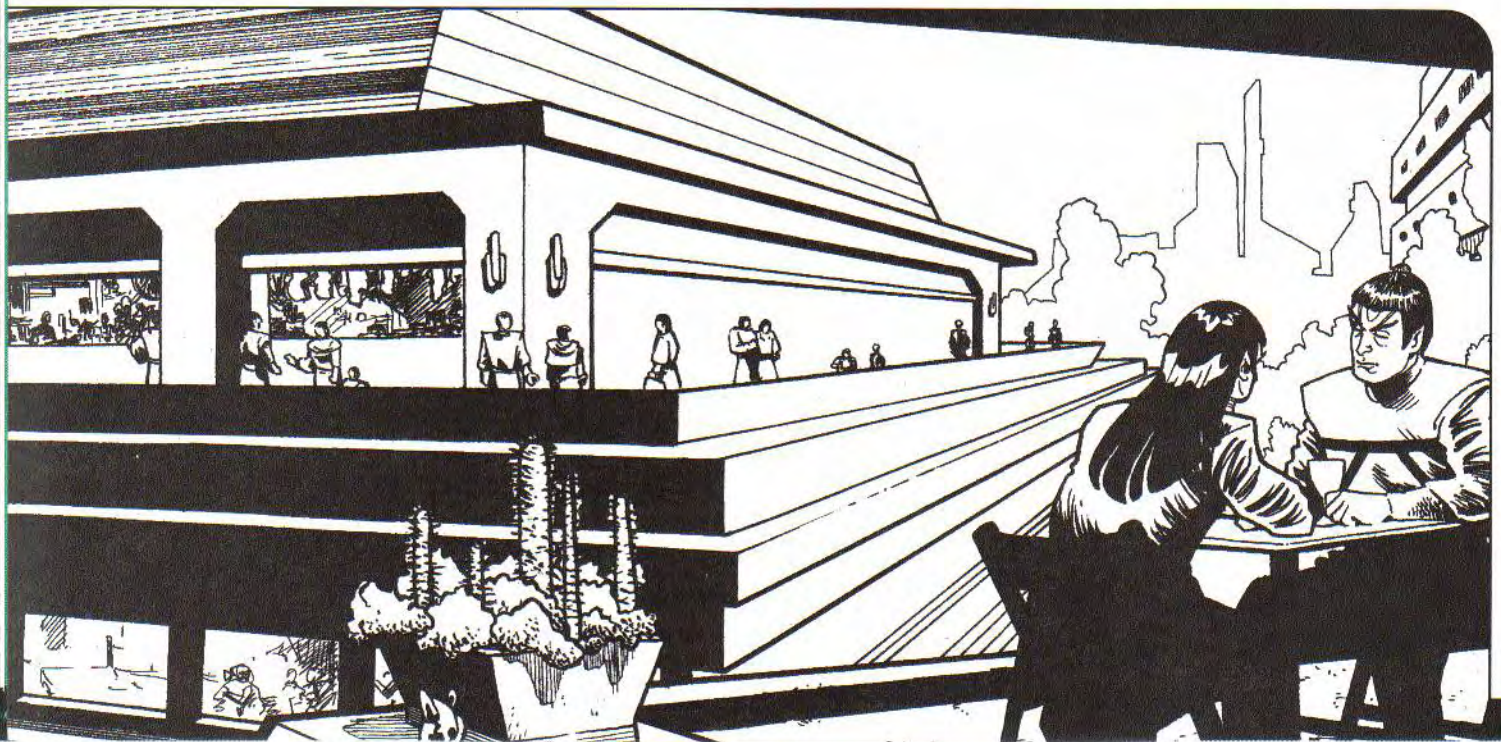

military manufacturing facilities, as well. Today, even after the *kavlarium* veins are mostly exhausted, it remains an important manufacturing and financial center.

THE MIDCONTINENT AND THE KELDRAK PENINSULA

Two mountain chains—the Anverok, which borders the region on the north, and the Des'Reval, which borders it on the south—dominate the central regions of Folloss. Due to its latitude and relatively high elevation, the region possesses a northern temperate climate which, while appealing to some, limits the growing season and thus, until the invention of replication technology, the number of people willing and able to live there comfortably. The only exception to this is the lower-lying Keldrak Peninsula on the western coast.

The Keldrak Peninsula thrusts out westward from the Folloss mainland, as if to point an accusing finger at the continent of Valcaria, which it almost touches. The narrow strip of water between them, the Jendranax Strait, has been an important Romulan commercial route for over a thousand years. The Jendranax Current which flows through it from northeast to southwest helps to warm the peninsula.

Located at the very tip of the peninsula is the sprawling city of Peldrad, which more than six million Romulans call home. The Romulans say that whatever one seeks—finances, fortune, fame, or philosophy—one can find in Peldrad. Much of Romulus' large entertainment industry bases itself here, and performers and poets can be found on the street corners and in the cafes. But the city is not just a mecca for entertainers and artists; it also has a thriving business and manufacturing community.

THE TEL'GARCH SUBCONTINENT

Romulans call the southern part of Folloss the Tel'Garch Subcontinent. In geographic terms, they define it as the watershed of the vast D'Gansar River, which flows almost straight south from the Des'Reval Mountains to empty itself into the Apnex Sea. Although not as fast or fierce as many rivers, the D'Gansar is the broadest river on the planet. At the river's delta lies the city of Atremon Trel, a busy port and commercial zone.

Atremon Trel is not the most interesting city on the D'Gansar, however. That distinction falls to Tephren, one of the holiest places on Romulus. Founded by several priestly orders a few centuries after the earliest Romulans landed on the planet, Tephren contains the largest, most ornate temples on Romulus. Even those who do not believe in the Romulan gods cannot fail to experience awe when they see the vast temple complexes.

Novok

Running parallel to Brel'kar, this narrow, mountainous continent was once part of a much larger landmass. It, along with the continents of Folloss and Umrika, formed a single continent that would dwarf any of the present-day continents. Millions of years ago, however, geological forces ripped this megacontinent apart, forming it into the progenitors of the three continents known today. Still other tectonic activity wore away at Novok, tearing islands away from it here and there, eventually forming several archipelagoes, including the D'vrex.



What remains today is a continent resembling a thin strip of land supported by a large chain of mountains, the Sen'lanarc. Where the continent "bends" slightly in the middle, a desert, the Ar'hael, has formed. Besides the desert and the high mountains, Novok has two major geographical regions: the northern equatorial zone and the southern temperate zone.

THE AR'HAEL

The largest remaining desert on Romulus, the Ar'hael fills the "bend" in Novok on the southern and western side of the Sen'lanarc Mountains. The mountains prevent the rain clouds which come south from Brel'kar from reaching that side of Novok, while winds sweeping down from the White Sea across western Novok drive away what rain might come east from the Garenak Sea, causing a desert to form. The result: a desiccated wasteland several million square kilometers in size.

The northern and southern edges of the desert contain some life—scraggly scrub bushes; small, twisted trees; birds and animals adapted to the dry conditions. Further in, however, the Ar'hael becomes more of a classic desert, displaying kilometer after kilometer of lifeless, undulating sand dunes. The sere majesty of the place strikes the souls of some visitors; somehow, even at its most lifeless, Romulus manages to impress. But even the most impressed visitors do not linger for long.

Only a few oases break the endless monotony of sand in the deep Ar'hael. Around these oases, some of which are quite large, cluster villages and small towns of hardy Romulans. Many of these inhabitants are scientists who study the geological forces at work in the desert, or the lifeforms which manage to eke out a hard-scrabble existence around the oases, but some are permanent residents whose families have lived in the desert for generations. These *unsa'avit*, as the Romulans call them, seem to value the isolation and privacy which a desert lifestyle affords them. According to popular thought, many of the *unsa'avit* harbor sympathy toward the aims of the dissident movement reluctantly led by Ambassador Spock.



KEROSH

Type: Grazing herd animal

Size: An average *kerosh* stands 1.5-2 meters tall at the shoulder and weighs 150-275 kg.

Form: Four long legs; broad back; elongated head and snout; broad, almost hairless tail; short fur typically colored gold-white, bluish-gold, or bluish-green

Attributes: Fitness 3 (Strength +1), Coordination 2, Instinct 3, Presence 2

Base Movement: 25

Resistance: 1

Special Abilities/Unusual

Skills: None

Weapons: Bite (Difficulty 6; does 1 point of damage)

Description/Notes: *Kerosh* are herbivores who live on the tough *tikrik* grass of central Umrika. As herd animals, they follow the strongest male in any given herd. Males often fight each other for dominance of a herd, especially during the springtime mating season.

NORTHERN EQUATORIAL ZONE

The equator splits the northern half of Novok, rendering much of it a tropical or subtropical environment. Only the northern third of it qualifies as temperate, but many of the people who inhabit this area believe it the nicest place on Romulus to live.

Three major rivers, each pouring down from the heights of the Sen'lanarc, flow through this part of Novok. The largest, the Balsanra River, is one of the few northward-flowing rivers on the planet. It is broad, deep, and slow; old folk tell many fanciful legends of the water spirits which inhabit it. In contrast, the other two, the H'relgath and the Tai'eld, are fast, noisy, and shallow. All three support many towns and small cities, which use them for water, commerce, and fishing.

The largest city in this part of the continent is Omrashar, located on the coast of the White Sea at the delta of the Tai'eld River. One of the earliest cities founded by the Romulans, Omrashar retains much of its sleepy, backwater feel. Tall buildings built mainly of distinctive ivory-colored and rust-red-colored stone line the narrow streets, blocking out the sweltering sun at all but high noon. Many Romulans vacation here to take advantage of the tranquil lifestyle.

SOUTHERN TEMPERATE ZONE

The southern third of Novok stretches south and east away from the equator until it just barely brushes up against the South Mendlanar Sea. One would normally expect parts of it to be much colder, but the currents in the Sea of Lerodan and warm weather patterns pushing down from Brel'kar keep the temperature raised to temperate levels.

The portions of the Sen'lanarc Mountains in this part of the continent were once extensively mined for minerals—everything from gold and silver, to rubies and emeralds, and even mundane (but still valuable) ores such as *veraktite* and *traxanite*. The former mining towns and cities—Kor'Marel, Vandrok, and Gav'ros Trel, to name the three most prominent—have all found other ways to support themselves. Fortunately, Romulan technology now allows their citizens to work less and enjoy life more. Coastal cities, such as Ch'eren and Varald, still fulfill their ancient roles as ports and shipyards, but today the ships they help to build are mainly spacecraft, not sailboats.

Umrika

Some Romulans call Umrika the "Southern Continent," because it is the only continent on the planet which exists almost entirely in the southern hemisphere. It ranges from the hot, humid, swampy, and jungle-covered Beld'Rath Peninsula to the spacious grasslands of the interior where the *kerosh* run, to the stark and chilly southern coastal plain. Romulus' most famous natural wonders, such as the Firefalls of Gal'Gathong and the Jeweled Forest of Ath'reshaar, attract thousand of visitors to Umrika every year.

THE BELD'RATH PENINSULA

The westernmost part of Umrika, above the western arms of the Wall of Fire Mountains, is known as the Beld'Rath Peninsula. It juts northward over the equator, approaching the continent of Valcaria but not quite touching it. The Terelix Strait, the Nelrek Ocean's only gateway into the Apnex Sea, runs between them.

Due to its position straddling Romulus' equator, Beld'Rath has an equatorial climate (except in its southern and eastern borders, where the rising elevation as one approaches the Wall of Fire cools the temperature somewhat). It rains frequently—in some places, on an almost daily basis—and the humidity can be intense and uncomfortable to those unused to it. Because of these weather patterns, houses and buildings here tend to be large and tall, with broad windows to catch the breezes and airy rooms to prevent stuffiness and mildew.

Similarly, the Romulans who live here have adapted their lifestyles to the peninsula's climate. Slower and more easy-going than most Romulans, they often have a much more relaxed attitude about many subjects. The Romulans say "a Beld'Rathian in the *Tal Shiar*" the same way that humans would say "a fish out of water," to indicate an unlikely or unfavorable combination of things, since few Beld'Rathians join the feared intelligence service. Beld'Rathians are also known for their often scanty garments, which scandalize "proper" Romulans from latitudes where thicker, more elaborate dress remains the only appropriate fashion.

The Beld'Rath contains few large cities; the soil and weather discourage such settlements. The only one of note is Fel'voth, on the western coast, which trades extensively with the Valcarian city of Mirek.

THE NORTHERN COAST

Umrika's northern coast, the strip of land above the Wall of Fire which the Apnex Sea gently washes with its purple waves, is one of the most temperate and delightful regions on Romulus (despite the occasional minor earthquake). Small cities and towns dot the coastal region; only Bareldak Trel, standing tall and proud at the southern end of the enormous Bay of Bareldak, could truly be considered a major city. By order of the Praetor, no other urban area in the region can grow big enough to become a metropolis; the Romulans want to preserve the area's countrified charm.

In the eastern half of the Wall of Fire which forms this region's southern border, in a beautiful, broad valley known by the undeservedly ominous name of H'aareld va Groth'Chok ("the Mouth of Perdition"), rests one of the galaxy's most amazing sights—the Firefalls of Gal'Gathong. The only remaining active volcano, *Karethvek*, generates the Firefalls. An enormous flow of lava cascades over the mountain's northern cliff side in a constant stream of magma. Some of the magma spreads out and cools at the base of the cliff, but most of it oozes back through cracks in the ground to sink into the depths of the planet. Romulans come from all over the quadrant to see the Firefalls and bathe in the valley's delightful hot springs.

THE CENTRAL PLAINS

Broad, windswept grasslands fill the central part of Umrika. An occasional small forest breaks the monotony of the *tikrik* grass. Most of this area remains wild; Romulan hands have disturbed nature but little here, as the Romulans prefer to maintain the region as a sanctuary for bird and beast. The most famous denizen of this region is the *kerosh*, a horselike quadruped. Many Romulans ride tame *kerosh* as a hobby. Romulans often travel to central Umrika on "nature safaris" to view thundering herds of wild *kerosh* running across the grasslands, seeing in their mastery of the plains an analogy to the eventual Romulan mastery of the Endless Sky.

EAST UMRIKA

Romulans refer to the temperate region between the Garenak Sea and Allerash Mountains as East Umrika. While many Romulans live here, typically in cities such as the megalopolis of Torven at the tip of the Vondrok Peninsula, the region is best known for another of Romulus' spectacular natural wonders: the Jeweled Forest of Ath'reshaar. Like the Wall of Fire, the Allerash Mountains contain many long-dead volcanoes (and a few which are but dormant). Millions of years ago, one of these volcanoes erupted, completely covering a nearby small forest with magma and ash. The trees died, of course, but as time passed the minerals in the lava and ash filtered into the wood, petrifying and preserving it. Eventually the soft stone around the petrified trees eroded away, leaving the trees to stand as stony monuments to their former verdancy. Thanks to tiny flakes of mica and similar minerals in their "bark," the trees glitter and sparkle in the light of sun and moons. The result:

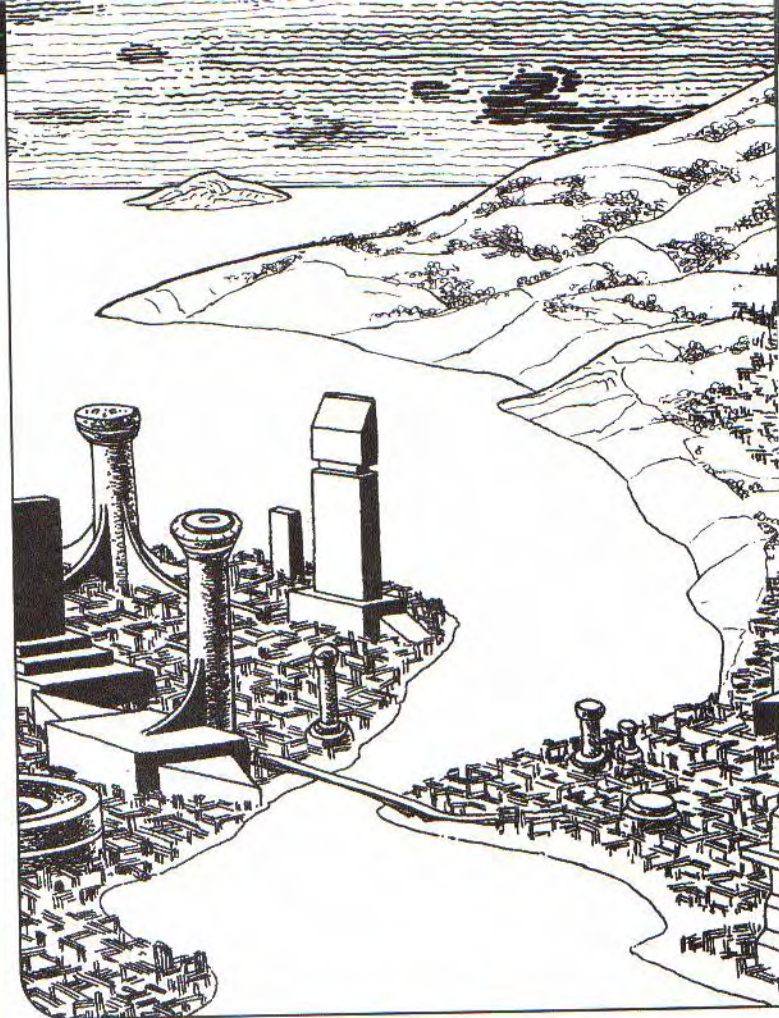

a forest of "jeweled" trees, unlike anything else in the galaxy, which draws thousands of Romulan sightseers every year.

Valcaria

Surrounded by the cold, choppy waters of the North Mendlanar Sea, the crashing surf of the Nelrek Ocean, and the gentle purplish waves of the Apnex Sea, Valcaria is a heavily inhabited continent with many cities and a lively economy. Mountainous in many places, and covered by several large forests, it manages to retain a certain wild and unsettled quality.

In shape, Valcaria vaguely resembles an enormous "L" tipped on its side. The lower bar—Southern Valcaria—points southward toward Umrika; the larger bar runs roughly parallel to the equator. About half of the continent's population lives in Southern Valcaria; the remainder is scattered across the wilder northlands. Very few people live on the northernmost coast, above the Ladrosh Mountains, for winters there are long, and even the summers are unpleasantly chilly.

SOUTHERN VALCARIA

South of the twisting, dagger-sharp peaks of the Raas'trek Mountain chain, Valcaria is temperate, with a fine climate marked by frequent rainstorms and several snowfalls each winter. One of the most heavily urbanized regions on the planet, Southern Valcaria contains three major cities—Mirek, Dorvek, and Kromtar Trel—and dozens of smaller cities.

Mirek, on the southern tip of the continent, was settled about one thousand years ago on bluffs overlook-



ing the Terelix Strait. Due to this advantageous location, Mirek quickly became a center of trade for ships and passengers traveling through the Strait. Controlled growth has allowed the city to retain some of its old-world features—narrow streets which encourage foot traffic rather than vehicles, streetlamps in the early Romulan style, and spacious villas and residential compounds hidden behind high walls.

Today, Mirek is a center for a different kind of travel—space travel. Orbiting high above are the Mirek Shipyards, one of the planet's most productive starship construction facilities, and a state-of-the-art spaceport at Mirek's edge provides the local factories with a conduit to send parts and supplies up to the Shipyards.

Dorvek, situated at the mouth of the river of the same name, serves primarily as a commercial port. People living in the interior ship large barges filled with goods to the city down the Dorvek River, which remains navigable for most of its length. Workers unload the barges at the city and transfer the goods to ships (whether water- or air-based) for journeys to every place on Romulus. Thanks to such extensive trade, Dorvek is a cosmopolitan city where Romulans from all over the planet, and indeed the Empire, mingle. Ever-changing fashions and styles constantly preoccupy many of the citizens.

Kromtar Trel is one of the interior cities which supplies goods to Dorvek. As modern and diverse as any Romulan city, Kromtar Trel nevertheless remains best known for its artistic heritage. Craftworks and art are two of the city's economic mainstays, and the famed Imperial Academy of the Arts calls Kromtar Trel home. Those wishing to experience the cultural life of the Romulans without the frenetic energy and pace of Peldrad come here to walk the shop-lined streets and sip fine local ales in small, family-run cafes.



TER'AK

Type: Pouncing hunter

Size: About 1 meter long (not including tail); weight about 50 kg

Form: Four-legged predatory cat relative, with large ears and eyes; fur color ranges from chocolate brown to tawny.

Attributes: Fitness 3 (Vitality +1), Coordination 4 (Dexterity +1, Reaction +1), Instinct 4, Presence 3

Base Movement: 15

Resistance: 2

Special Abilities/Unusual Skills: None

Weapons: Claws/Bite (Difficulty 5, 2+1d6 damage)

Description/Notes: A medium-sized predatory cat relative, the *ter'ak* is known for its fearless, and sometimes vicious, nature. There are many recorded instances of unprovoked attacks on adult Romulans.

NORTH-CENTRAL VALCARIA

In primeval times, several enormous forests covered the north-central region of Valcaria. Today cities and towns break up the forests, but large portions of them have been preserved almost untouched. To the Romulan mind, this region will always remain a dark and foreboding place where one can easily get lost amid the trees and fall prey to a vicious *ter'ak* (a small, agile, cat-like pouncing hunter) or take a tumble into one of the small, rushing rivers and drown.

The stereotypical north-central Valcarian is a quiet, serious, driven individual who seems to keep wildness and chaos at bay almost by sheer force of will. Romulans who live here tend to support the Praetor with extreme loyalty and long service; the *Tal Shiar* obtains many recruits here.

EASTERN VALCARIA

Eastern Valcaria slopes away from the Ladrosh Mountains and the forested north-central region to form a flat, rocky plain which runs down to the North Mendlanar Sea. Historically it was always the least inhabited region of Valcaria, and that remains true today. Most of the people cluster into two large cities, Hlarek and Avretrel, both located on the eastern coast. Romulans who live inland have the reputation of being intensely private loners who don't care to have their privacy invaded.

REMUS



Romulus' sister in the *Ket-cheleb* system, Remus has never had the pleasant climates and striking vistas which makes Romulus a paradise to her people. Although possessed of a stark beauty and a wealth of natural resources, Remus has never captured the Romulan heart the way Romulus does, despite the fact that it was the scene of the Romulan Star Empire's first great military victory. The always practical Romulans have found many ways to make Remus an important part of their Empire, however. Indeed, after Romulus itself, it is perhaps the key world in the Empire, for it houses the Romulan military-industrial complex and provides many raw materials to Romulus.

This chapter looks at Romulus' counterpart—Remus, the arsenal of the Romulan Star Empire. Most minor details, such as the names of specific provinces, leaders, and the like, are typically left for the Narrator to create for her own campaign, so that they will better fit into the Narrator's ongoing series or storyline.

The Planet

Like its sister Romulus, Remus is a class M world, but the two provide an excellent example of the wide variation which can exist between two class M planets. Somewhat smaller than Romulus, with a diameter of 11,450 kilometers at its equator, Remus is also cooler, with an average temperature of 16.5° Celsius. The atmosphere contains the usual Class M mixture of oxygen and nitrogen; relatively heavy concentrations of greenhouse gases (such as carbon dioxide) remain as a reminder of the days before industrial replicators and the lack of pollution controls. Remus has an atmospheric pressure somewhat heavier than that of Romulus; many Romulans find it mildly uncomfortable until they acclimate to it. Cloud cover can often be heavy, contributing to the planet's sometimes oppressive feel.

Remus possesses only a small tropical belt, within about eight degrees of latitude on either side of the equator. Its subtropical regions are similarly small; the bulk of the planet's landmasses fall into the temperate and northern temperate zones. The tropical and subtropical regions often experience violent storms, up to and including hurricanes, during the late summer and autumn; tornadoes may strike in some southern temperate areas during the spring and summer.

CONTINENTS

Remus has four continents—Astrakoth, Goreb, Kel'var, and Valis'Shar—spread over three landmasses. Valis'Shar and Astrakoth are connected, much like Europe and Asia on Earth. The dividing line between them is the Korex River, the longest river on the world. Only the Astrakoth-Valis'Shar landmass crosses the world's equator; Goreb lies entirely south of the equator, and almost all of Kel'var is north of it. A large group of islands, the Zandranek Archipelago, shows where Goreb and Kel'var were once connected by an isthmus.

Remus suffers from much greater tectonic instability than Romulus. Three major faults traverse the world, each of them cutting through one or two continents. The Western Fault runs through western Goreb and Kel'var and slowly splits each of them down the middle. The Central Fault runs at a slight diagonal through western Goreb and central Valis'Shar; the Matarek Peninsula of Goreb and the subcontinent of Tansarr in northwestern Valis'Shar are both the result of its handiwork. The Eastern Fault neatly



REMUS HIGH PORT

Type: Service (trade base)

Location: Orbiting Remus (*Ket-cheleb IV*)

Commissioning Date: 2268

HULL CHARACTERISTICS

Size/Structure: 6/Central cube approximately 1 kilometer on each side, with other modules projecting from all six sides.

Resistance: 5

Structural Points: 450

Docking: Up to four dozen trade ships with docking connections 180 meters broad or smaller can dock at the High Port at one time.

PERSONNEL CHARACTERISTICS

Crew/Inhabitants/Capacity: 1,512/1,800/28,000 [8 Pwr/rnd]

Entertainment: 8 [24 Pwr/rnd]

SYSTEMS CHARACTERISTICS

Computers: 6 [6 Pwr/rnd]

Transporters: 24 personnel, 48 cargo [36 Pwr/rnd]

Tractor Beams: Six major tractor arrays arranged to cover a 720° arc around the station; hundreds of smaller arrays designed to assist ships with docking and unloading cargo [2 Pwr/rating/rnd]

Power: 425

SENSOR SYSTEMS

Long-range Sensors: +0/12 light years [6 Pwr/rnd]

Lateral Sensors: +0/1 light year [4 Pwr/rnd]

Sensors Skill: 3

Internal Security: 4

WEAPONS SYSTEMS

Type I Disruptors

Range: 10/30,000/100,000/300,000

Arc: All (720°)

Accuracy: 4/5/7/10

Damage: 24

Power: [24]

Plasma Torpedoes

Number: 500

Launchers: 12

Arc: All (720°)

Range: 15/300,000/1,000,000/3,000,000

Accuracy: 4/5/7/10

Damage: 20

Power: [5]

Weapons Skill: 3

DEFENSIVE SYSTEMS

Romulan Deflector Shield

Protection: 60/60/60/60

Power: [60]

Ships: 6 Romulan warp shuttles, 24 Romulan shuttles, 50 Work Bee-type craft

Notes/Description: The Remus High Port serves as a trading point for all non-Romulans, who are not allowed onto the surface of Remus. Tight security prevents unauthorized visits to the surface of the planet; looser measures apply to trading itself, provided merchants pay all applicable taxes and no one attempts to smuggle dangerous contraband items.

bisects Astrakoth; the enormous peaks of the Thalek'Kar Mountains rise up where its two plates have crashed together over countless millennia. Earthquakes (and, to a lesser extent, volcanic eruptions) occur often on Remus; the Romulans learned early to build their homes and factories as sturdily as possible.

OCEANS

Remus has two large oceans and two major seas, in addition to the waters surrounding the polar ice caps (which lack names of their own; maps simply designate them both as "Polar Sea"). The Kor'Ren Ocean divides the Astrakoth-Valis'Shar landmass from the other two continents. The Baltaric Islands, a small archipelago along the equator right in the middle of the Kor'Ren, are considered one of the most beautiful places on the planet; Romulan factory managers often award loyal, hardworking employees with a weekend's vacation at one of the resorts there. Several other small groups of islands are scattered throughout this ocean.

On the other hand, the Andrack Ocean, larger than the Kor'Ren by about thirty percent, contains few islands. Deep, turbulent, and often wracked by storms, the Andrack destroys ships and batters coastlines with seeming glee. Since its waters teem with fish and other sea life, and abound with dissolved minerals which enormous mining ships can suck up and process into usable materials, the Romulans have learned to live with the Andrack's caprices.

The Sentravean Sea, which holds Goreb apart from Kel'var, is much the opposite from the Andrack Ocean, despite being fed by it. Its calm waters serve as a perfect conduit for trade between the two continents and the ZandraneK island chain between them. When a major storm gets started in the Sentravean Sea, however, the two continents and the islands bottle it up so that it builds in strength until it moves inland and unleashes its fury on some hapless city or province.

Remus' other major body of water, the South Goreb Sea, fills the enormous basin between Goreb proper and the Matarek Peninsula which descends from its northeast corner. Its waters are deep and cold, and near the coastlines are sometimes fouled with left over pollutants as well. Fishermen who ply the South Goreb sail far out into it before casting their nets.

MOONS AND SATELLITES

No moons orbit Remus. Its nighttime sky still holds an interesting sight or two, however. One of them is the planet Romulus, which hangs in the vault of night like a tiny *d'eret*-fruit waiting to be plucked by anyone with a long enough arm.

Closer to Remus itself are several orbital manufacturing facilities and bases. The most important of these to the average citizen of Remus is the Remus High Port, a vast mercantile and trading base. Since Romulan law prevents non-Romulans from visiting Remus (see below), Remus' merchants and businessmen meet outworlders here.

The other structures orbiting Remus contain ship construction and maintenance facilities (such as *Jaralek'Vanar*, a massive spacedock capable of building as many as twenty *D'deridex*-class warbirds at once), military research and development bases, and miscellaneous other orbital factories (ore processing centers, pharmaceutical laboratories, and the like). A popular rumor on Remus maintains that the *Tal Shiar* has a cloaked orbital base somewhere above Remus, but every version of the story describes the base differently.

THE QUARANTINED WORLD

As mentioned above, Remus cannot be visited by non-Romulans, an inviolate law which has been in place since the

REMUS

Planet Name: Remus (Ket-cheleb IV)

Class: M

System Data: Remus has no moons. It is the fourth of ten planets orbiting the Romulan sun, *Ket-cheleb*. Romulus (*Ket-cheleb* III) is also Class M; the inner two planets are Class D and F, respectively; the outer six planets consist of Class G and J worlds. An asteroid belt which the Romulans mine exists between *Ket-cheleb* VI and VII.

Gravity: 1.1 G

Year and Day: 410/23.25

Atmosphere: Oxygen-nitrogen, with slightly greater than Earth-normal pressure

Hydrosphere: Water covers approximately 71% of Remus' surface.

Climate: Standard Class M climate, but slightly cooler than normal; temperate and northern temperate zones predominate.

Sapient Species: Romulans (2.4 billion); Zelvorians (5.8 million)

Tech Level: Six

Government: Republic

Culture: Often perceived as a militaristic, honor-bound culture, Romulan civilization actually exhibits a wide range of cultures, behaviors, and customs. Reman culture is much poorer than that of its sister Romulus; Remus has been given over almost entirely to production and manufacturing, with little attention paid to cultural matters.

Affiliation: Romulan Star Empire

Resources: Remus possesses extensive natural resources. Although not well suited for agriculture, its resources make it ideal for mining, manufacturing, and similar economic development.

Places of Note: Kathlar Trel (capital city), Strellad Gorge, ruins of Salaya, Dalerok Battlefield, Zelva'tresht

Ship Facilities: Jaralek'Vanar (orbital ship construction and repair base), ship facilities orbiting Romulus; three lesser facilities scattered throughout the system

Other Details: See text.

Romulans began to develop Remus as their manufacturing center. The Praetor and Senate fear that if outworlders were allowed to go down to Remus, they would be able to spy on the Empire's military technology development centers and other manufacturing facilities. This would, of course, pose a severe danger to the safety of the Empire. Non-Romulan visitors found on Remus are arrested, then summarily tried and executed; no exception to this practice has ever been granted.

The only exception to this ban on aliens concerns the local Zelvorians. After the Romulans conquered Remus, the decision was made to enslave the Zelvorians, turning them into an indentured workforce. They would provide the labor considered too menial, or too dangerous, for Romulans. The remaining Zelvorians were herded into

reservations, which eventually grew into small Zelvorian villages. The Romulans imposed a "one child" program on Remus's natives, to keep the population small, and thus not a threat. Zelvorians are prohibited from traveling off-world. Since this time, the few remaining Zelvorians work in the Empire's factories, assembling components for everything from warbirds to PADD's.

Astrakoth

The continent of Astrakoth, the southern part of the landmass shared with Valis'Shar, is generally considered the best real estate on Remus. It suffers from few of the extremes of climate that bedevil many other parts of the world. Most of it is temperate, and, where it crosses the equator, the immense Thalek'Kar Mountains raise the elevation and cool the temperature to reasonable levels. Because so many Romulans want to live in this part of Remus, there are only a few tiny Zelvorian villages here.

BETWEEN THE RIVER AND THE MOUNTAINS

The northernmost part of Astrakoth borders the Korex River. The most important geographic feature is not the river, however, but the Thalek'Kar Mountains. Beginning not far south of the headwaters of the Qallasa River, the Thalek'Kar Mountains thrust their snow-capped peaks at the cloudy sky above them for well over two thousand kilometers. Although parts of them remain virtually unspoiled, every few kilometers along another mining operation or mountain factory can be found.

A little over a third of the way south down the Thalek'Kar, the Tiama Valley cuts through the great mountain chain as the Tiama River flows westward toward the Korex. Located just north of the equator, the Tiama Valley is covered with verdant subtropical forests and jungles where several native Reman monkey species and many other animals live. So, too, do many Romulans, in the city of Balstara. Built in a quasi-Zelvorian style—mostly single-story buildings with low, rounded roofs and large basements—Balstara boasts a thriving pharmaceutical industry. The forests, jungles, and wildlife of Astrakoth have yielded many new and important compounds, thanks to the efforts of the many Romulan scientists who work in the Balstaran laboratories. Rumors of an extensive *Tal Shiar* presence among the researchers remain unproven.

THE ZELVORIAN PLAINS

Traveling further down the Thalek'Kar, one finds the mountains dividing a vast region of plains and woodlands in half. The eastern half, between the mountains and Astrakoth's Andrack coast, forms a hot, dusty savanna, once home to gargantuan herds of antelope-like *hresta* and the predatory cats and dogs which hunted them. Since this area holds little of interest to the Romulans, they forced several of the larger Astrakothan communities of Zelvorians to migrate here centuries ago. Today, the predatory animals are extinct, and the *hresta* nearly so, due to Zelvorian hunting.

MERAKA TREL AND LERAS'NEV

The plains on the western side of the Thalek'Kar, on the other hand, are temperate, with plenty of rain to irrigate them. As the plains roll further to the west, they

RESISTANCE ON REMUS

If the Crew are members of the Romulan resistance, or sympathetic to it, they may find the eastern Zelvorian Plains a good place to hide. Since the Romulans have little presence here, and one can find many sympathetic Zelvorians (who would be happy to obtain a better place to live and more power in society), the savannas may make ideal "bolt-holes" when things get too hot in the more civilized parts of Remus. There are few places to buy supplies, however, so characters who go there should come equipped with plenty of food and other essentials.

give way to woodlands and hills which eventually slope down to the Kor'Ren Ocean. Two Romulan cities control this fertile and well settled region: Meraka Trel and Leras'nev.

Meraka Trel, also known as the "City in the Clouds" because of its high elevation, occupies the heart of the Thalek'Kar. It started as a mining town, and many mines can still be seen nearby. Today it takes the raw materials pulled out of the mines and makes things with them: armor plating for starship hulls, focusing crystals for military and scientific applications, even toys and housewares for Romulan citizens. Every Romulan knows that the cloud-shaped seal of the Merakan Commerce Board indicates a quality product.

The raw materials which Meraka Trel does not use are shipped to Leras'nev for that city's own factories. Leras'nev's economy depends on a tripod of manufacturing, agriculture, and mariculture. Huge ships pull up to its immense spider web of docks and wharves every day to unload fish and goods, take on loads of goods and agricultural products, and so on in a never-ending cycle which does as much to define the Leras'nevan day as does the rising and setting of the sun.

DALEROK BATTLEFIELD MEMORIAL

Far to the north of these two cities, almost at the equator, is the Dalerok Battlefield Memorial, which commemorates the Romulans' victory over the Zelvorians nearly two thousand years ago. On this site the Romulans' military forces trapped the Zelvorian army in a shallow valley and annihilated it, sealing the Romulan conquest of Remus. The memorial, made of *gadanite* transported to Remus from Romulus, consists of a pavilion with a statue of the great General Keltras, who won the battle that day with his clever tactics; an enormous museum detailing every event in the battle; and tours of the battlefield. Restored antique weapons have been arranged on the battlefield to show visitors how the opposing forces were arranged.

By law it is a capital crime for any Zelvorian to approach within five kilometers of the Dalerok Battlefield Memorial.

ZELVA'TRESHT

In the far southern part of the plains stands the only remaining major Zelvorian religious site on Remus—an enormous ring of sculpted stones and obelisks which the Romulans call Zelva'tresht (the "Zelvorian Stones"). Most of the enormous stones weigh over a dozen metric tons. Their arrangement corresponds, in part, to the rising of the sun on certain days of the Reman year. The meaning of the placement and positioning of other stones remains an enigma which the Zelvorians refuse to explain. Earning the right to make a pilgrimage to the Zelva'tresht is a goal of almost every Zelvorian worker, and more than one anti-Romulan riot has flared here over the centuries. The Romulans use the threat of demolishing the shrine to keep the Zelvorians in line most of the time; they seem to believe that some great catastrophe will occur if anyone moves or damages the stones.

Goreb

West of Astrakoth and south of Kel'var lies Goreb, a continent where harsh steppes and barren plains have been ravaged for resources and raw materials. Some Romulans call it the "Brown Continent" because it seems so colorless and grim to them (particularly to those who have spent time on Romulus).

THE EASTERN STEPPES

A large mountain range, the Ghestara Mountains, divides Goreb into an elevated eastern steppeland and lower western plains. The Ghestaras are small and worn down, like the teeth of an old *seldrak* dog, and were mined out long ago.

Several Romulan cities—sprawling, cheerless places full of buildings made of gray-brown bricks—are located in the steppes. The largest and most important of them, Penvar, sits at the delta of the only significant river running through the region, the Vedrel. Penvar manufactures heavy machinery, everything from farming equipment to construction vehicles to mining drills. Its squat factories once belched smoke and chemical byproducts into the air and other pollutants into the South Goreb Sea, before the advent of industrial replicators; the sea still shows signs of pollution.

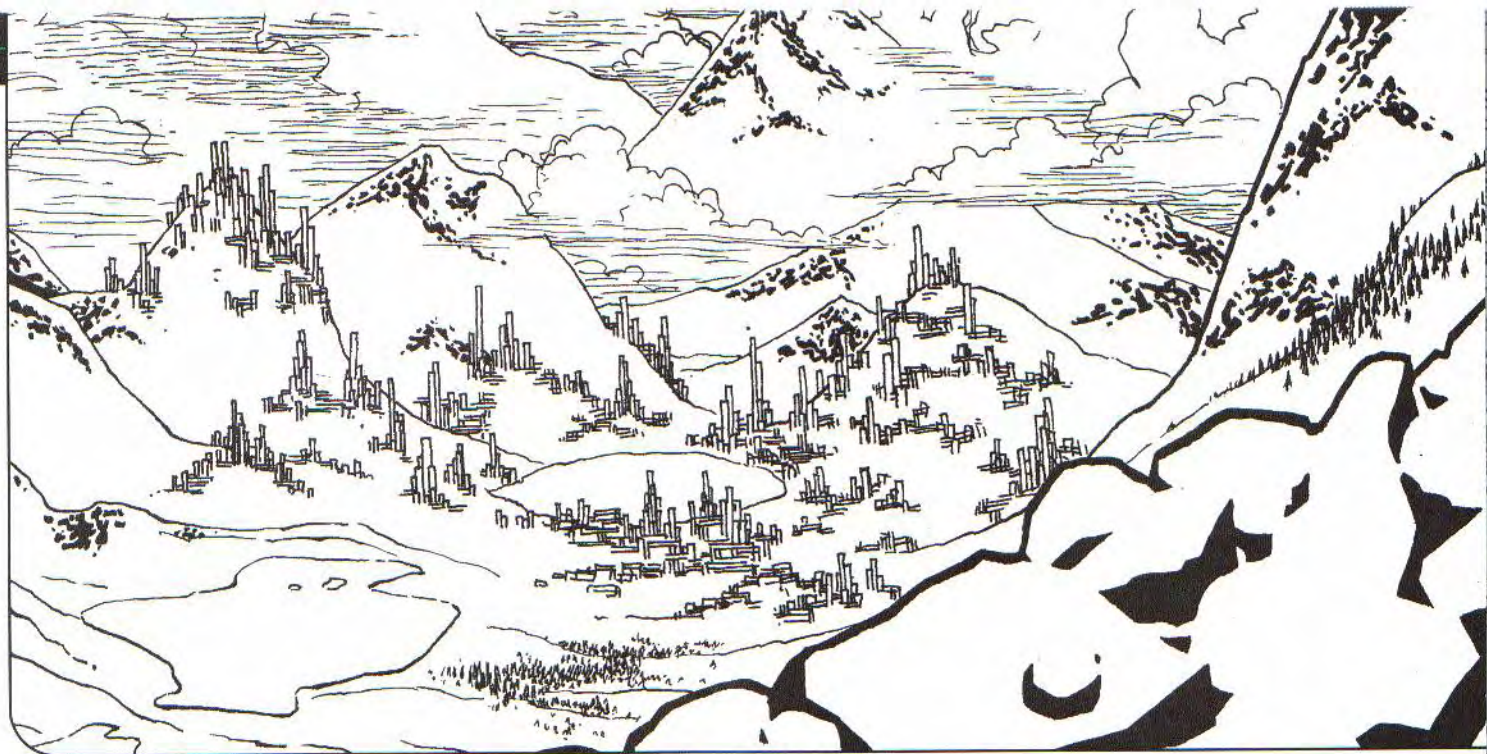

Being sent to one of the steppe cities is usually regarded as a punishment. Romulans who have failed at other jobs, who are disciplinary problems, or who have difficulty adapting elsewhere may soon find themselves toiling away in a drab job in a factory or office here. Still, a few Romulans like it here; the isolation, the rough beauty of the steppes in springtime, and the dry climate appeal to some.

MATAREK PENINSULA

Hanging from northeastern Goreb like an enormous drop of blood is Matarek Peninsula. This entire body of land, millions of square kilometers of it, falls under the control of the Romulan military. Contingents of heavy infantry guard all checkpoints, and ships and aircraft constantly patrol the coast.

The Romulans conduct some of their most top-secret military research on Matarek. Here one finds the development labs, testing ranges, proving grounds, and training facilities where loyal Romulan soldiers learn how to use all types of materiel and military technology. Unauthorized presence on the Matarek Peninsula constitutes a capital offense.

THE NORTHERN WOODLANDS

North of the Ghestara Mountains, which bend slightly to the east below the headwaters of the Vedrel River, Goreb turns temperate and wooded. Once exploited heavily by the Zelvorians, these forests now protect small communities of Romulans from the harsh winds blowing down from the Ghestaras.

SALAYA

Almost in the middle of this region exists the largest Zelvorian ruin on Remus, the former city of Salaya. Destroyed by Romulan foot soldiers nearly two thousand years ago, Salaya was left to rot for over a millennium. Then Romulan scholars began excavations here, uncovering and restoring what were once large and majestic Zelvorian buildings, giving some Romulans a new appreciation for the once-proud culture of their Reman subjects.

The excavations at Salaya continue today, for it will take centuries to excavate such a large ruin completely. Some Romulans say that small groups of Zelvorians sneak into the ruins at night to worship at their crumbled temples and peer at the worn carvings on their ancestors' lintels—and perhaps, say some rumors, for more sinister purposes. A few people believe the Zelvorians seek something, some object or datum, though what that might be remains uncertain.

WESTERN GOREB

The two thirds of Goreb which lies west of the Ghestaras features dry plains covered with short grasses, scattered woodland areas, and a large number of lakes fed by underground streams and springs. The underlying land is composed mainly of limestone and similar minerals, and sinkholes and low, swampy areas occur with some frequency, especially near coasts, rivers, and the line of the Western Fault. Many businesses strip-mine the limestone and minerals for use in construction and similar industries.

Beyond the fault line, the western subcontinent contains a region where extensive oil deposits were discovered over a century ago. Thanks to careful management of this asset, the Romulans are still able to pump oil there today; estimates say that the remaining reserves here, and in untapped fields beneath the waters of the eastern Andrack, amount to several billion barrels.

Several cities, including Torm'reth and Belshar, have grown up around the oil wells and the industries which support them. These cities use a large spaceport, *Travenkha*, to ferry the oil into space to the Remus High Port for shipment to planets which still use oil-based technology.

Kel'var

Kel'var, the northern partner of Goreb, combines a dash of the tropics with a large temperate region, a vast central expanse of mountains known as the Torek'Tan, and a northern zone which just barely crosses into the arctic to create what would normally be a very pleasant place to live. The Romulans have overpopulated much

The Romulans

of Kel'var, covering it with cities, homes, and many factories. Unfortunately, such heavy occupation has spoiled the one area on Remus which once approached the scenic beauty of Romulus.

KATHLAR TREL

Although not as large as Valis'Shar or Astrakoth, Kel'var holds the seat of the Reman planetary government. The world's capital, Kathlar Trel, covers hundreds of square kilometers along the shoreline of a wide, shallow bay on the southeastern corner of the continent. A planned community, Kathlar Trel was built in a series of "blocks," each about a half a kilometer on a side. The blocks were further broken down into sub-blocks and neighborhoods, each with its own school, park, and other amenities. As more and more Romulans came to Kathlar Trel, though, the careful planning which characterized the city's early growth gave way to a more disorganized and eclectic style of city management.

Today, a visitor to Kathlar Trel can easily tell when different parts of the city were built based on their appearances. The orderly, neat, thoroughly Romulan city center is the oldest part of the city. Beyond that lie belts and developments where a more "Reman" aesthetic, influenced partly by Zelvorian forms, holds sway—the buildings are much less uniform, the streets not always straight. The "suburban" areas and satellite communities beyond that take many different forms.

The center of the city's civic life is, as with Val'danadex Trel, a wide plaza. Kathlar Trel's plaza is known as Dalerok Forum. About one square kilometer in size, the Dalerok Forum is lined with a series of fountains with statues, each of which commemorates one of the Romulans' victories over the Zelvorians. The largest fountain, in the very center of the plaza, honors the soldiers who died at Dalerok. The entire forum is paved in Kedossian marble from Romulus; no vehicles may drive on it.

The Reman Senate Building, also made of Kedossian marble, towers over the western side of the forum. The Romulan representatives of Remus meet here to conduct local planetary government when they are not meeting on Romulus with the other senators of the Empire. Matching it on the eastern side of the forum is the Tellurad, the spiritual heart of Remus. Built over a thousand years ago by the famed architect Kunderak, it stands as a monument to *D'era*. Inside, it houses reminders of Romulan greatness, and displays extolling Romulan achievements. Many Romulans on Remus choose to take their *Serona* oath here, before one of the Tellurad's pontices (and a recruiting officer).

STRELLAD GORGE

An unusual geological formation exists in western Kel'var, just south of the Torek'Tan Mountains, at the northern terminus of the Western Fault. It is a vast gorge, or valley, many kilometers long and wide, where the very land seems to have fallen away to reveal the base bedrock beneath it. In several locations throughout this place, named Strellad Gorge after its discoverer, hot springs and geysers bubble up out of the ground. Some resorts have grown up here to offer "soothing baths" to wealthy Romulans.

Strellad Gorge contains more than hot springs, though. According to some Romulan paleoanthropologists, it may hold clues to the origin of the Zelvorians. The wild and uninhabited northern end of the gorge apparently contains fossils or artifacts of the earliest proto-Zelvorians. Scientists have explored it for years, finding only a few objects offering tantalizing glimpses into Zelvorian history. Two years ago a group of scientists announced they had made a major find. Before they could release details, the Romulan government clamped down on them and their research camp. Since then Romulan soldiers have occupied the northern part of the gorge, preventing any unauthorized visitors from entering it. What was found, and what it means, remains a mystery.

Valis'Shar

Valis'Shar, the largest continent on Remus, also contains its greatest diversity of climates and ecological zones. The far northern part of the continent extends well into the planet's arctic region, making life there difficult at best. Many of the facilities in that part of the world are sheltered beneath huge, heated domes, or are simply so large that they function as towns, with residences, commercial districts, and manufacturing areas on different levels or in different parts of the overall structure. As one travels further to the south, beyond the mountainous Tansar

subcontinent, however, the land's elevation drops considerably and the climate quickly becomes temperate. The slope of the land continues for hundreds of kilometers down to the continent-spanning Korex River, which marks Valis'Shar's boundary with Astrakoth. The closer one gets to the river, the warmer the weather becomes; the Korex delta region is tropical and swampy.

THE TANSARR SUBCONTINENT

The northernmost section of Valis'Shar, which the Central Fault is slowly but surely splitting off from the main section, is called the Tansarr subcontinent. The name derives from an old Zelvorian word meaning "land of mountains." No more accurate words were ever spoken on Remus, for three great mountain ranges traverse the land: the Jhal'Kerak Mountains, which form a southwest-northeast bulwark which cuts the northwestern peninsulas off from the rest of the subcontinent; the Dannerif Range, which occupies the southernmost part of the Tansarr; and the towering Valstorean Mountains, which cut a neat northwest-southeast line through the very heart of the subcontinent.

Remus' tallest mountain, Mount Alashk'Tar, is part of the Valstorean range. One of the last and greatest battles between the Zelvorians and the early Romulans was fought in the valleys which cluster all around Alashk'Tar's feet; one who looks carefully may still find a few rusty Zelvorian buckles and broken weapons, or perhaps, if one's luck runs true, a long-forgotten Zelvorian body preserved by the mountains' cold weather.

EBROST MINING COMPLEX

Needless to say, mining and related industries dominate the Tansarr economy. The largest of the many mines and mining towns is the Ebrost Mining Complex, owned by the Romulan company of the same name. Nestled within a broad valley in the western half of the Valstorean Mountains, Ebrost controls over two dozen major mines.

Uridium, *gentadium*, and many other valuable minerals and metals pour out of the Ebrost mines every day. Because many of these minerals have military uses, the Ebrost mines constitute a strategic resource; a substantial garrison of Romulan soldiers has been posted here to guard them and maintain order. Drills and other mining machines perform most of the heavy labor, including virtually all of the dangerous work, but a nearby town of over seven thousand Zelvorians supplies the laborers needed to do the countless menial tasks which must be performed in and around the mines.

ZELTROSE SHAR'N TRAINING

Romulan characters who spend most or all of their *Serona* at Zeltrose Shar'n should take the Physical Fitness package option under the *Serona* Life History section of their Background History. This reflects the physical development which comes from living in such a demanding environment. The scruffs while away the long winter nights by playing games and getting into fights, so, based on their experiences at the camp, characters could justify buying such skills as Planetside Survival (Northern Temperate), Unarmed Combat (Brawling), or Gaming (choose character's favorite game as a Specialization) at some point during character creation.

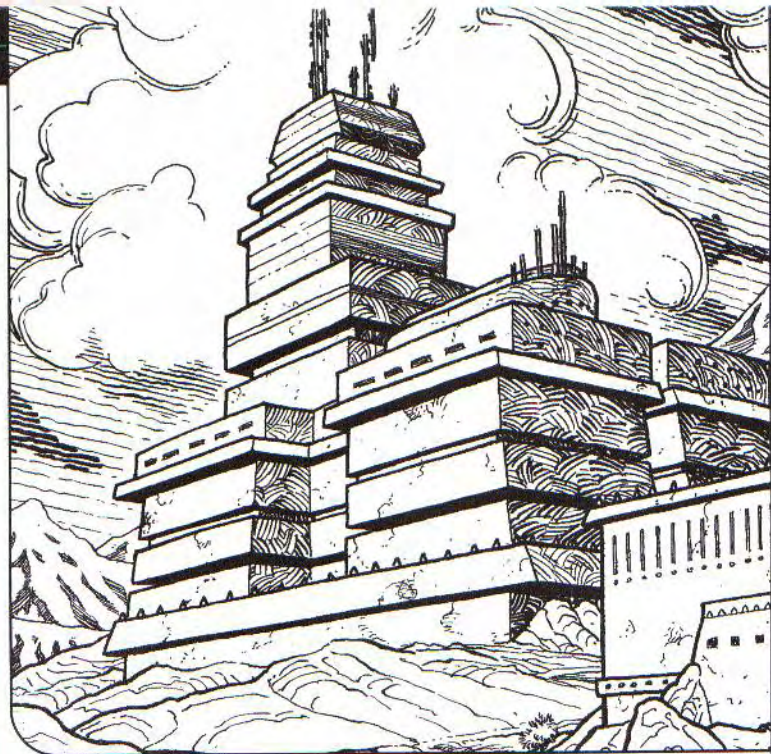

THE VULTRIC PENINSULA

Much wilder and less developed than the Tansarr, the Vultric Peninsula juts out of the northeast part of Valis'Shar like a wing from the back of some great beast. Centuries ago, when the Romulans conquered Remus, this area was earmarked for "future development," but with so much other mineral wealth to exploit in more hospitable climes, the Vultric Peninsula ended up being left wild. Now that some of the older, more established mines begin to play out, however, some Romulans cast eager eyes toward the potential wealth locked within the peninsula's hard, rocky soil and thick coniferous forests. A few Romulan engineers have already proposed establishing testing stations with the latest mineralogical equipment to evaluate the possibilities.

For the present, though, there remains only one major Romulan settlement on the Vultric Peninsula: Zeltrose Shar'n, a training camp for young Romulans serving their *Serona* duty. *Serona* recruits are sent to Zeltrose Shar'n (or any of several similar camps located elsewhere on Remus) to prepare them to work with the Romulan military for the rest of their service period. Those who show little promise may never get beyond Zeltrose Shar'n; these unlucky "scruffs" must spend their entire tour of duty in Zeltrose Shar'n's frigid barracks, going on endless hikes through the Vultric woods.

CHAM'REA

The central temperate region—for which the Romulans use the Zelvorian name, Cham'rea—encompasses most of the land drained by the great Korex River and two of its three major tributaries (the Nech'a and the Qallasà). The Korex actually begins in the southern part of the Vultric Peninsula—its headwaters rise in a range of high hills there, the F'esu—but all except a few kilometers of its length lie in the Cham'rea.

Before the arrival of the Romulans, the Cham'rea was heavily populated by the Zelvorians. Today, hidden under two centuries of decay and plant growth, the ruins of many a Zelvorian building or travel marker still exist, waiting to be found (Romulans who live in the Cham'rea sometimes make a hobby out of such minor archaeolo-

TRELKA

Type: Pouncing hunter

Size: *Trelka* can grow to be up to 2 meters long. Many tales are told of much larger ones, but no such specimens have ever been captured or reliably seen.

Form: Snake

Attributes: Fitness 2, Coordination 3 (Dexterity +1, Reaction +1), Intellect 2, Presence 2

Base Movement: 8

Resistance: 2

Special Abilities/Unusual Skills: Spring-leap (see below)

Weapons: Bite (Difficulty 7). The *trelka's* bite does 1 point of damage; if the victim takes damage, the *trelka's* fangs will poison him. The poison causes 3 points of damage per round (Resistance does not apply), beginning three rounds after the victim was bitten, until the victim is dead or an antivenin is administered.

Description/Notes: The *trelka* is a large green, black, and red snake. It usually can be found in the trees searching for birds (its normal prey), but will also take small ground-based mammals or even fish and other reptiles. It is able to coil itself up into a "spring" and lunge out in a lightning-fast leap of up to 10 meters to catch its prey; it also tends to launch itself this way at anything which surprises or corners it.

gy). Near the Tas'Taree Mountains in the west, and the junction of the Tiama and Korex rivers, Zelvorian communities can be found next to Romulan military outposts and factories. These communities remain small, thanks to harsh Romulan enforcement of their "one child" policy for the Zelvorians.

The temperate climate and copious supply of water make the Cham'rea ideal for manufacturing facilities. Unfortunately, many of the industries here have yet to modernize, and still operate under a pre-replicator paradigm. The plumes of smoke, ash, or steam from these factories never stop rising to the heavens to make the seemingly omnipresent cloud cover worse.

Some Romulans argue to relocate Zelvorians from more desirable areas and resettle them here, and forgo the modernization of Cham'rea's industrial complex. Since the Korex supplies drinking water as well, care is taken not to pollute it too badly, but the many lakes which can be found in the region make fine dumping grounds for all sorts of waste. Many Zelvorians suffer from diseases caused by exposure to the pollutants.

THE KOREX DELTA

The southernmost part of Valis'Shar is the region around the Korex River's terminus in the Kor'Ren Ocean. As it reaches the coast, the river fans out to form a delta, which in turn broadens into a vast morass called, with precise accuracy, the Great Dismal Swamp. Due to the difficulties involved with constructing buildings or running factories inside the swamp, not to mention the presence of dangerous animals such as the *trelka* snake, the Romulans have mostly left the swamp alone.

Just above where the delta begins to form lies the enormous city of Guthara, built over the razed Zelvorian city of the same name. Home to over four million Romulans, Guthara is a major center of military industry. Factories in the industrial belt surrounding the city proper make, among other things, parts of starship hulls, military body armor, disruptor parts, and some of the delicately machined pieces needed to construct quantum singularity power-generating systems.

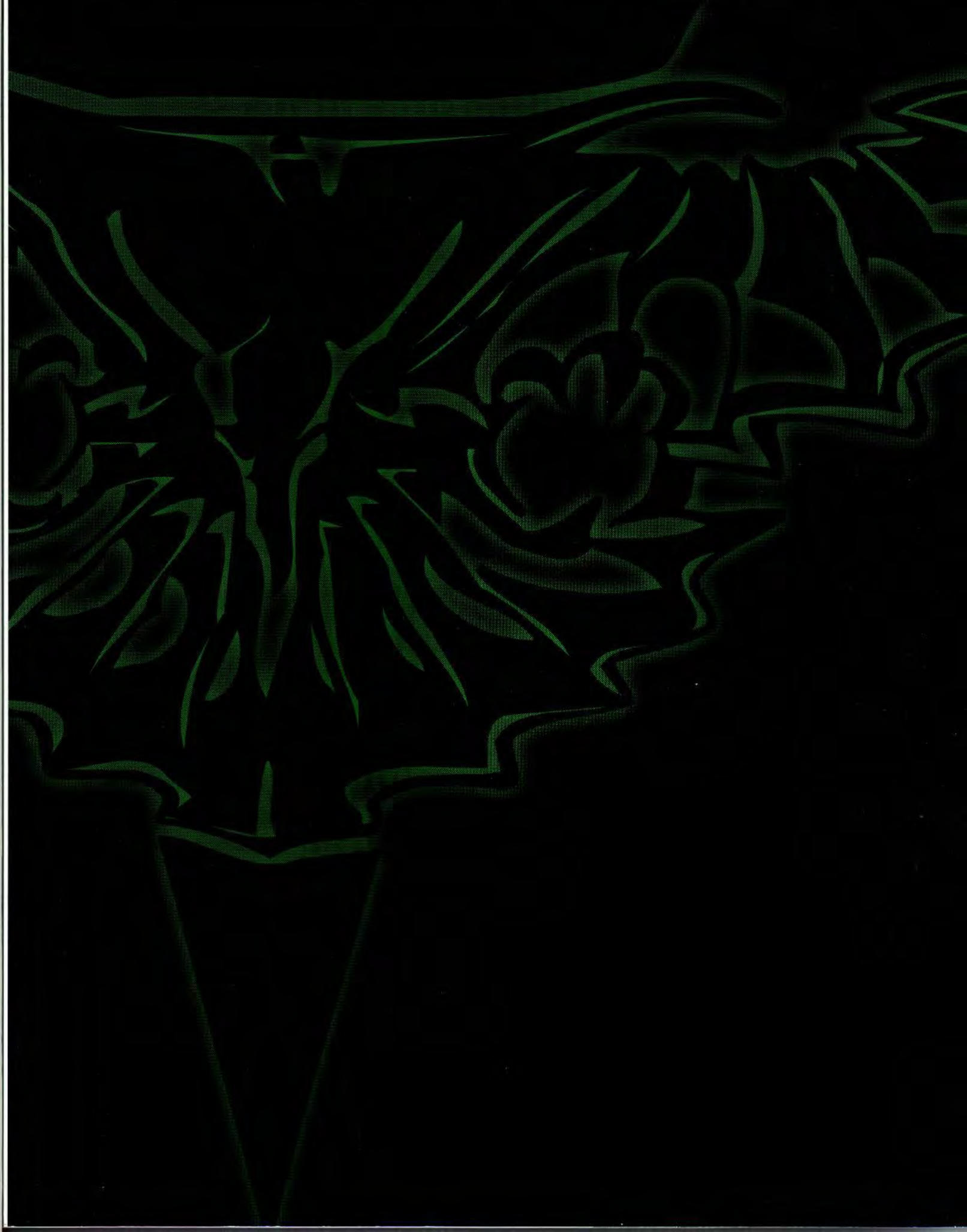

STAR TREK
THE NEXT GENERATION®

*Romulan
Characters*



BOOK 2

T H E W A Y O F D ' E R A

Romulan Characters

T H E R O M U L A N S T A R E M P I R E



B O O K 2

AUTHORS: JAMES ESTES, ROSS A. ISAACS, EVAN JAMISON, STEVE KENSON, STEVE LONG, RICHARD MEYER, CHRISTIAN MOORE, PETER SCHWEIGHOFER

DEVELOPMENT: KENNETH HITE, ROSS ISAACS, CHRISTIAN MOORE

EDITING: JANICE SELLERS

STAR TREK: THE NEXT GENERATION® LINE DEVELOPER: ROSS A. ISAACS

GRAPHIC DESIGN: ANTHONY VAYOS

ART DIRECTION: RYAN MOORE, ANTHONY VAYOS

ORIGINAL ART: JOE CORRONEY, BARRY DOYLE, MARK FORRER, JOHN GRIGNI, PIA GUERRA, TERRY PALLOT, CRAIG SKAGGS

MAPS & CARTOGRAPHY: CHARLES RYAN, BARRY DOYLE

LAYOUT: ALVARO RIET

PRODUCT DEVELOPMENT, PARAMOUNT: PAUL RUDITIS

PROOFREADING AND FACT CHECKING: BILL MAXWELL

SPECIAL THANKS: TO MARK LENARD, FOR BEING THE FIRST. TO JOANNE LINVILLE, FOR EASILY BEING THE MOST MEMORABLE. TO ANDREAS KATSULAS, FOR REDEFINING THE ROLE. AND TO KENNETH HITE, FOR DESTROYING HIS SHIP RATHER THAN SURRENDERING.

DEDICATION: WE, THE PROUD HEIRS OF THE EMPIRE, DEDICATE THIS PRODUCT TO D.C. FONTANA AND PAUL SCHNEIDER. IN THE PRAETOR'S NAME.

DISCLAIMER: WHILE LAST UNICORN GAMES HAS RESEARCHED EXTENSIVELY TO MAKE THIS THE MOST AUTHENTIC *STAR TREK: THE NEXT GENERATION* ROLEPLAYING GAME POSSIBLE, THE DEPTH OF INFORMATION NECESSARY FOR A FULLY-REALIZED ROLEPLAYING GAME IS NOT ALWAYS REVEALED DURING A WEEKLY TELEVISION SHOW. WHILE WE HAVE TRIED TO EXTRAPOLATE LOGICALLY WITHIN THE FLAVOR OF *ST: TNG*, SOME LIBERTIES HAVE BEEN TAKEN AND PLAYERS SHOULD REMEMBER THAT ONLY THE EVENTS, CHARACTERS AND PLACES THAT APPEAR ON THE SHOW OR IN FILMS ARE CANON.

LAST UNICORN GAMES
9520 JEFFERSON BLVD., SUITE C
CULVER CITY, CA 90232
WWW.LASTUNICORNGAMES.COM

FIRST PRINTING — APRIL 1999
PRINTED IN CANADA



STAR TREK
THE NEXT GENERATION®
ROLEPLAYING GAME



Distributed to the book trade by Simon & Schuster, 1230 Avenue of the Americas, New York, NY 10020
STAR TREK™, ® & ©1999 Paramount Pictures. All Rights Reserved. STAR TREK and Related Marks are Trademarks of Paramount Pictures. Last Unicorn Games, Inc. Authorized User.
©1999 Last Unicorn Games

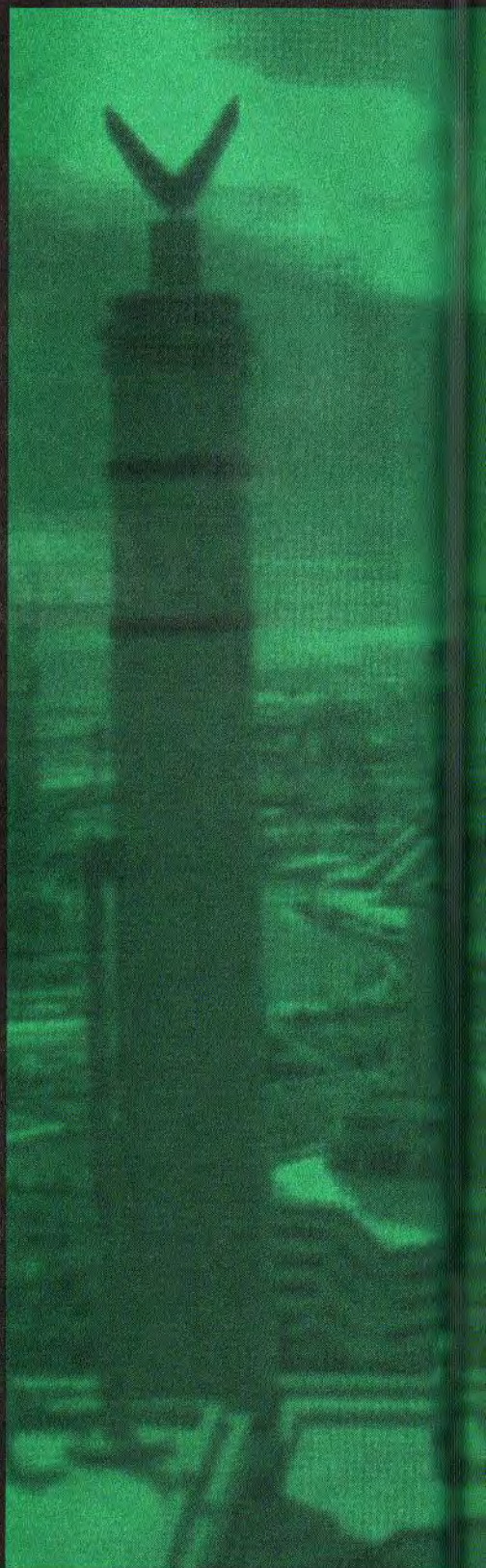

TABLE OF CONTENTS

| | |
|----------------------|----|
| CHARACTER CREATION | 5 |
| ROMULAN TRAITS | 9 |
| SCIONS OF THE EMPIRE | 23 |
| ROMULAN SERIES | 37 |



WE ARE

ROMULAN.

THAT IS THE

ONLY TRUTH.

CHARACTER CREATION



Romulan characters are created using pretty much the same process as the basic character creation rules for the *Star Trek: The Next Generation Roleplaying Game*—those found on pages 55–111 of the core rulebook. The player chooses a Template, adds an Overlay, and then choose options based on the character's Background History. Of course, Romulans have their own Overlays and Background steps. A number of unique Romulan Overlays and Background History options are described in this chapter.

When creating a Romulan character, you're going to have to think a bit differently. In *Star Trek*, the Romulans are typically portrayed as the "bad guys." Think of Commander Sela, supporting the Duras family during the Klingon Civil War in the hopes of destabilizing their neighbors. Or Commander Tomalak's attempt to capture the *Enterprise-D*. Even when Romulans are characterized as honorable—like Mark Lenard's Romulan commander in "Balance of Terror"—their methods are portrayed as aggressive, duplicitous, and cruel. Who would want to play such a character?

Romulan characters are a lot of fun to play, but they are considerably different from Starfleet characters in several substantial ways. Although similarly bold and inquisitive, they sometimes lack the compassion and "heroic" virtues displayed by Starfleet personnel. After all, Romulans come from a society based on, in large part, aggression, violence, and conquest, a civilization where intense political infighting (and everything which it entails) is frequently the norm, and spies and informers are a fact of everyday life. Although they are far from savages, compared to Starfleet characters they sometimes seem cold and brutal.

While you and your fellow players may want to create cold and brutal characters, this doesn't begin to explore the Romulans from the Romulan perspective. The Romulan people possess many admirable qualities. For example, many of them are honorable citizens who try to do the "right thing", at least as they and the Empire see it. The Romulans don't see themselves as warlike, aggressive, or cruel, and if you're going to play a Romulan then you have to disregard the stereotypical Romulan. Put yourself in a Romulan's shoes for a while, to understand why they do what they do. They possess a fundamentally different point of view from Federation citizens.

Star Trek: The Next Generation has certainly shown us plenty of ruthless, scheming, and vicious Romulans, but it's also shown us Romulans who care deeply about their crews, who are devoted to what they consider noble and worthwhile tasks, and who deal with their enemies in an honorable, even trustworthy, fashion. Follow their example on your path into the Endless Sky.

The Measure of a Romulan

Every character is, of course, an individual, and individuals are often different—sometimes very different—from the stereotypical members of their society. It's quite possible to imagine "oddball" characters such as an aggressive Ferengi, a calm and contemplative Klingon, and so forth. This applies to Romulans, too. Not every Romulan must support the Empire, believe in *D'era*, or get involved in politics. Not every Romulan needs to be cunning, vicious, and cold. Indeed, player character Romulans will often be the iconoclastic



members of society; heroes frequently "stand out" from the crowd, moving through life by testing cultural limits, going against the prevailing moral and social grain.

It's important to remember that Romulans grow up in Romulan society, and that's likely to color their attitudes, habits, and preconceptions, much in the same way that growing up Vulcan or human shapes Vulcan and human characters. Therefore it's a good idea to keep some of the better-known or more common Romulan traits in mind when designing a Romulan character.

Remember that every individual will have different ways of interpreting or manifesting these traits; just because a Romulan is aggressive doesn't mean that he initiates a fight whenever the opportunity presents itself. What about an aggressive diplomat? Or a scientist who is aggressive about pursuing his research? Use these traits as a jumping off point, as a foundation from which to explore your character's Romulan psyche.

AGGRESSION

Self-confidence combined with passion often leads Romulans to charge headlong after whatever it is they want, be it a planet, a position in the Imperial Senate, or a spouse. Once a Romulan commits to a particular course of action, he usually puts everything he's got into achieving that goal. Romulan commanders often use similarly bold, decisive tactics once a battle has been joined. *D'era* justifies Romulan aggression: If a species is unwilling to accept Romulan rule and Romulan ways, it must be made to see the errors of its ways. A Romulan who has a healthy dose of this trait might be Bold or Innovative; on the other hand, he may also become Vengeful, develop a Rival or a Sworn Enemy, or cause other problems for himself.

Romulan aggression does not always lead Romulan characters to act recklessly, however. In fact, Romulans are renowned for their cautious and often reactive natures. The Romulans didn't develop

cloaking technology by mistake; they deliberately sought that technological achievement as a method of keeping their ships concealed until they were ready to strike.

Romulans prefer to observe and tempt an enemy into action; they then react and counter the enemy's move decisively by means of their often elaborate contingency plans. However, as discussed above, when they do hit back, they often hit back hard and aggressively.

CURIOSITY

Perhaps a holdover from their ancient Vulcan roots, perhaps related to their passionate, aggressive natures, the Romulans aggressively pursue knowledge in all of its forms. One interpretation of *D'era* suggests that in order for the Romulans to assume their destiny as masters of the universe, they must understand its secrets.

Romulan curiosity may also be one of the motivations behind the intricate plans and actions of the *Tal Shiar*, which likes to stick its nose wherever it pleases. The Curious, Innovative, and Eidetic Memory Advantages can be used to represent this aspect of the Romulan personality.

HONOR

Romulan honor is a curious concept. Romulan soldiers will ruthlessly attack defenseless colonists on the one hand, but on the other exhibit the tempered qualities of nobility, fairness, and integrity. Romulans seem to respect those they think deserving of their esteem, but have little regard for those they consider weak or inferior. Individual Romulans treat each other with honor, because they are Romulan.

While it does not necessarily make a given Romulan honest or trustworthy, it usually means he can be counted on to keep his word once it is given. Terrorism and espionage are thus acceptable instruments to achieve goals, and do not make Romulans any less honorable in their own eyes.



PASSION

The second most important Romulan quality, one perhaps closely related to self-confidence, is that of passion. Like their Vulcan forebears, and unlike their current Vulcan "cousins," Romulans do not suppress their emotions. In fact, they all too often give in to them, acting rashly or passionately when they would do better to be a bit more rational.

Thus, Romulans are often described as temperamental, moody, vengeful, or cunning. A Romulan's passionate nature, roleplayed properly, can add a lot of depth both to his character and to the series; its negative aspects, such as temper, also make good tragic flaws. Disadvantages such as Impulsive, Rival, and Vengeful may be used to simulate the fiery emotions of the Romulan personality.

SELF-CONFIDENCE

Perhaps the most characteristic Romulan trait, Romulans, particularly those in important positions, tend to be self-assured and confident of success. To other species they encounter, this attitude sometimes seems to border on, or even cross over into, sheer arrogance. Romulans often have no doubt of their success in any given venture, whether that success comes now or later.

The overarching philosophy of *D'era* remains one of the primary motivating factors behind the legendary Romulan self-possession. They believe they are the worthy descendants of the Vhorani, who created the Romulan species at *Vorta Vor* (the Romulan Eden), and are thus destined to shepherd the galaxy into a glorious new age. Most Romulan characters will be strong individuals, and should possess some form of self-confidence. It might even be reflected in the character's Advantages (Resolute and Strong Will are two possibilities).

The Romulan Template

To play a Romulan character, players should choose the Romulan Template (see the accompanying box). As in the *Star Trek: The Next Generation RPG* core rulebook, the number in brackets indicates the usual maximum level which a Romulan can achieve in a particular Attribute. Exceeding the indicated level would require the Narrator's permission and a very good reason.

TYPICAL ROMULAN FEATURES

The typical Romulan stands between 1.6 and 1.9 meters tall, though some individuals are significantly taller or shorter. Their weight and build approximate those of humans. Their ears are pointed, though the points are usually not as pronounced as those of Vulcan ears.

Romulans have a bony ridge over each of their eyes which slants upward from inside to outside. To some humans this makes them look perpetually angry or annoyed, a psychological factor which likely affects their reactions to Romulans (conversely, human faces often appear to display surprise, mildness, or lack of aggression to Romulans, which may make some Romulans think of humans as weak).

ROMULAN

Attributes

Coordination 2 [5]

Fitness 2 [6]

Strength +1

Intellect 2 [5]

Perception +1

Presence 2 [5]

Empathy -1

Psi 0 [6]

Skills

Culture (Romulan) 2 (3)

History (Romulan) 1 (2)

Language

Romulan 2

Law (Romulan) 1 (2)

Science, Any (choose type and Specialization) 1 (2)

World Knowledge (Romulus) 1 (2)

Romulan hair and eyes are almost always dark; blonde Romulans are extraordinarily rare, and red or auburn hair is almost unheard of. The hair is usually cut in a severe style which leaves it plastered close to the head. This traditional style creates the distinctive sharp angles along the hairline near the ears and at the center of the forehead (where it typically comes to a kind of point or peak). Some humans have speculated that this hairstyle is reminiscent of old Romulan military helmets.

Romulan Overlays

The next step in the character generation process is to choose an Overlay that represents the character's profession, occupation, and/or general direction in life. Of course, society in the Star Empire is vast and multifaceted, and there are many more possible occupations than those listed in this chapter. The Overlays provided represent the types of professions players are most likely to want to play as characters, or whom Crew members who work for Starfleet are most likely to encounter. If you feel something is missing, feel free to create your own Overlay; use one of the existing Overlays as a foundation.

Romulan society is rigidly organized and stratified. A person who chooses a profession or career usually has to stick with that choice; most Romulans see this as their duty to the Empire. In many cases it also allows them to develop a high level of expertise in their chosen profession. Some Romulans—those in the military or with powerful benefactors, for example—have many more opportunities to learn and try new things, however. A Romulan military officer is as learned and well rounded as his Starfleet counterpart, and is often more devious to boot.



ROMULAN DIPLOMAT

Administration (Romulan Government) 2 (3)
 Computer (Research) 1 (2)
 Culture (choose Specialization) 2 (3)
 Diplomacy (choose two Specializations) 2 (3) and (3)
 Espionage (Observation) 1 (2)
 History (choose Specialization) 1 (2)
 Languages
 Romulan 1
 Player's Choice 2
 Law (Romulan) and (choose Specialization) 1 (2) and (2)
 Persuasion (Debate or Negotiation) 2 (3)
 Social Sciences (Political Science, Economics, or Sociology) 1 (2)
 World Knowledge (choose two Specializations) 1 (2) and (2)

DIPLOMAT

While much of the political power in the Empire resides with the Senate, it takes a vast bureaucracy to operate a government the size of the Romulan Empire. Among this bureaucracy is the Foreign Service, the department charged with maintaining the Empire's external relations. Diplomats form one of the government's most influential political classes.

The Romulan Empire does not depend solely on military conquest as a tool of statecraft. If negotiation can achieve the Empire's aims, the Romulans do not hesitate to employ it. Romulan diplomats receive extensive training in negotiation at the Imperial Academy.

The velvet glove concealing the Empire's iron hand, diplomats serve as the Empire's public face. They comprise the delegations who attend trade conferences, appear before government bodies (like the Federation Council), and negotiate on the Romulans' behalf. Yet they also serve as a reliable source of information for the military. More than one Romulan diplomat has provided insightful intelligence on a planet's military capability, or a leader's willingness to go to war. Many believe, especially those outside the Romulan government, that Romulan diplomats are actually *Tal Shiar* spies. Diplomats also serve as liaisons with the Empire's client worlds, intermediating between a Romulan governor and the local populace.

Diplomats attend one of many popular Romulan universities, alongside future intercessors, politicians, and bureaucrats. There they study the history and culture of various civilizations (Taurhai, Federation, or Klingon, for example), making them more versed in alien cultures than the average citizen. Romulan universities admit applicants based on academic achievement, though more than one prominent family has pulled strings to get a relative admitted.

Oftentimes, a diplomatic career serves as a springboard to higher office, including a possible

Senatorial seat. Because diplomats possess first-hand knowledge of intergalactic affairs, both within and outside Romulan space, and frequently travel to other worlds, many senators maintain close contact with at least one diplomat.

Players involved in a political campaign might portray a diplomat, or a Romulan diplomat might be assigned to extended duty on a warbird—perhaps to advise a commander during the quelling of an uprising or to negotiate a treaty with a new alien species. Finally, a diplomat might become disillusioned with the Empire's direction, and join the resistance movement.

ROMULAN INTERCESSOR

Administration (Romulan Government) 2 (3)
 (Romulan Courts) (3)
 Charm (Influence) 1 (2)
 Computer (Research) 2 (3)
 Fast Talk 1
 Intimidation (Cross Examination) 2 (3)
 Language
 Romulan 1
 Law (choose two Specializations: Contract, Corporate, Intergalactic Law, Military Regulations, Specific Planetary/Government, Taxation) 2 (3) and (3)
 Mediation (choose Specialization) 2 (3)
 Personal Equipment (choose Specialization) 1 (2)
 Persuasion (Negotiation) 1 (2)
 (Oratory) (2)
 Social Sciences (Political Science) 1 (2)
 Streetwise (Locate Information) 1 (2)

INTERCESSOR

In Romulan society, intercessors serve much the same function as lawyers did on ancient Earth. They draw up contracts between individuals, mediate disputes, and represent their clients before the Romulan courts.

The Romulan system of justice resembles that of the Cardassian Union or the Napoleonic Code on ancient Earth: The accused is considered guilty until proven innocent. Unlike the Cardassian system of justice, however, the state's finding is not presumed automatically to be correct. The accused can still prove his innocence. Intercessors are not state employees, and they have powerful tools to protect their clients, such as the Romulan Right of Statement.

In civil disputes, most Romulans prefer to engage the services of an intercessor. In an effort to avoid embarrassment, they avoid taking their disputes to court, where airing "dirty" laundry could have dire consequences. Romulan judges have wide latitude in settling cases—everything from finding summarily in favor of one side or the other, to determining penalties from imprisonment to confiscation of property.

Similarly, the *Tal Shiar* monitors court activity, in an effort to root out disloyal activities. A citizen willing to violate a contract, or who cannot get along with his neighbors, is more likely to commit other crimes as well. Should an intercessor, during the course of his duties, learn of any disloyal activity on his client's behalf, the *Tal Shiar* expects to be informed.

Intercessors attend one of the Romulan Empire's prestigious universities, alongside future diplomats, bureaucrats, and politicians. Entrance is based solely on academic qualifications, though some prominent families use their influence to enroll a younger son or daughter. People who become intercessors range from those who want to help others to those hoping to use the position to propel them into the Senate. Many end up working for the government, either as prosecutors or as legislative assistants.

A Romulan intercessor is most likely to be a player character in a dissident or political campaign. The intercessor might work for the justice system, prosecuting traitors to the Empire, or work in the Senate as an advisor to an influential (or not so influential) senator.

ROMULAN MERCHANT

Bargain (choose Specialization) 2 (3)
 Charm (Influence) 2 (3)
 Computer (choose Specialization) 1 (2)
 Dodge 1
 Fast Talk 1
 Language
 Romulan 1
 One Other 1
 Law (Mercantile Regulations) 1 (2)
 Merchant (choose two Specializations) 2 (3) and (3)
 Personal Equipment (choose Specialization) 1 (2)
 Planetside Survival (choose Specialization; usually Urban) 1 (2)
 Shipboard Systems (choose two Specializations) 1 (2) and (2)
 Vehicle Operations (choose Specialization) 1 (2)
 World Knowledge (choose two Specializations) 1 (2) and (2)

MERCHANT

Although the Romulan Star Empire has replicators just as the Federation does, not everyone has access to them—only the military, the government, and certain other elites are allowed to use them in many instances. Therefore, the Romulan Empire maintains a more or less traditional economy. This, in turn, has given rise to a thriving merchant class.

The sort of Romulan merchant who is likely to be a player character is one of the traveling merchants/cargo carriers who are found throughout the galaxy. They travel from planet to planet and city to city, bringing desired goods and exchanging them for

money or other goods. Some work a predetermined route and sell the same products most of their lives; others are more adventurous, going wherever the available cargo or almighty *sestar* takes them. Merchants must receive a license from the government to conduct business; the license must be renewed every few years—a way for the government (and the *Tal Shiar*) to retain oversight over itinerant merchants.

Merchants in Romulan space often have to take extra care not to attract suspicion. Romulan society, being rather rigidly organized and devoted to military goals, does not always look kindly on people who travel frequently. The *Tal Shiar* frequently keeps a close watch on Romulan merchants, since it tends to suspect them of engaging in smuggling, dissident activities, or worse conduct.

The truth is, the *Tal Shiar* isn't always wrong. More than one merchant makes a lot of his money by smuggling illegal or quasi-legal goods, carrying messages for spies, and the like. Some of the most daring (or profit-hungry) merchants actually smuggle goods back and forth across the Neutral Zone into Federation space!

There are a few Romulan goods (Romulan ale, for example) which are in high demand in certain parts of the Federation, and many Federation goods can be sold for a pretty *riyal* back on Romulus. A person with a bit of dash and daring can do well for himself—if he manages not to get caught, all the while avoiding the Imperial authorities.

ROMULAN SCIENTIST

Skills

Computer (Simulation/Modeling) 2 (3)
 (choose Specialization) (3)
 Dodge 1
 Engineering, Any (choose Specialization) 2 (3)
 History (Romulan Science & Technology) 1 (2)
 Language
 Choose one 1
 Personal Equipment (choose Specialization) 2 (3)
 Planetside Survival (choose Specialization) 1 (2)
 Science, Any (choose three Specializations) 2 (4), (4), and (3)
 Science, Any other (choose Specialization) 1 (2)
 Shipboard Systems (Sensors) 1 (2)
 Vehicle Operations (choose Specialization) 1 (2)

Advantage

Security Clearance +3

SCIENTIST

The Romulan scientist is, typically, a graduate of the Romulan Astrophysical Academy. Like his Federation counterpart, he is usually intelligent, insightful, and resourceful—though of course the Romulan world of science has known plenty of intellectual plodders and “absent-minded professors,” too.



In the manner of scientists all over the galaxy, the Romulan scientist normally chooses one or more "specialties," a subject or subjects that he studies more than others. These are usually indicated by his Specializations in the first Science Skill listed on the Overlay. The remaining Science Skills describe other areas of interest or related subjects with which he is familiar through his researches or the study of his specialties. For better or worse, in the modern era science is such a vast field that it's no longer possible for most scientists to be "generalists" who know something (or even just about everything) about most fields of study.

In Romulan society, scientists are often employed by the military, whether as part of a starship's crew or as the professional staff of some state-owned defense industry. While most are content with, or even proud of, this role, a rare few object to being "tools of war-mongers." These scientists often aid, or are directly a part of, the dissident movement.

ROMULAN SENATORIAL AIDE

Skills

Administration (Romulan Government) 2 (3)
 Charm (Influence) 1 (2)
 Computer (Hacking) 1 (2)
 Espionage (choose Specialization) 1 (2)
 Fast Talk 2
 History (Romulan) 1 (2)
 Intimidation (Bluster) 1 (2)
 Language
 Romulan 1
 Law (Romulan) 2 (3)
 Persuasion (Oratory) 1 (2)
 Politics (choose Specialization) 2 (3)
 Stealth (choose Specialization) 1 (2)
 Vehicle Operations (choose Specialization) 1 (2)

Advantage

3 points worth of Contacts (either three +1 contacts or one +3 contact)

SENATORIAL AIDE

The business of the Empire is both complex and time-consuming. All members of the Romulan Senate require a staff to help keep them apprised of situations, prepare reports and briefs, see to daily affairs, schedule meetings, advise them on important matters, and even keep them abreast of political machinations. Typical positions include legislative affairs assistant, chief of staff, and military advisor.

The covert aspect of the job is perhaps the most interesting, and little seen, function of being a senatorial aide. The Romulan Senate is rife with plots and counterplots. Coalitions shift, fortunes rise and fall,

plots are hatched. An important function of any senatorial staff is keeping abreast of these shifts. Simply put, aides are little more than political bodyguards and spies, watching for plots and enacting their own. When Senator Mavet proposed an increase in the relief allocation to farms flooded in the Chula Valley, it was his senatorial aides who detected Senator Retam's plot to divert this to the military.

Ironically, these individuals end up wielding a great deal of power in Romulan politics. Senators cannot possibly keep current with all the matters before the Senate, and they depend on loyal assistants to keep them informed. It is a senatorial aide who determines who shall see the senator, advises him on important matters, and influences the way he will vote. Some have even gone on to their own seats in the Senate. Wise individuals with business before the Senate ensure that the senator's aides are on his side.

TAL SHIAR AGENT

Skills

Athletics (choose Specialization) 1 (2)
 Behavior Modification (choose Specialization) 1 (2)
 Computer (choose Specialization) 1 (2)
 Dodge 1
 Energy Weapon (Disruptor) 2 (3)
 Espionage (choose Specialization) 2 (3)
 Intimidation (choose Specialization) 2 (3)
 Personal Equipment (choose Specialization) 1 (2)
 Security (choose Specialization) 2 (3)
 Shipboard Systems (Tactical) 1 (2)
 Surveillance (choose Specialization) 1 (2)
 Unarmed Combat (Romulan Navy Martial Arts) 1 (2)
 Vehicle Operations (choose Specialization) 1 (2)

Advantage

Security Clearance +3

TAL SHIAR AGENT

Use this Overlay for a character who is a member of the dreaded *Tal Shiar*, the Empire's secret police and intelligence agency. Full details about the *Tal Shiar* can be found in the chapter entitled "The Defenders of *D'era*" in the first book of this set.

SOLDIER

Every Romulan serves in the military for a five-year period of time, called the *Serona*. After their requirement to the Empire is complete, many Romulans return to civilian life and take up civilian careers. Those who prefer the martial life remain in the military and become professional soldiers.

The life of a soldier is an exciting one. Romulan soldiers might see action along the Taurhai border, play cat and mouse with Federation starships along

the Neutral Zone, or bring glory and honor to the Empire by subjugating a new planet. Those who show promise reach the highest echelons, or receive transfers to one of the Empire's elite units.

ROMULAN SOLDIER

Athletics (choose Specialization) 1 (2)

Computer (Research) 1 (2)

Dodge 2

Energy Weapon (Disruptor) 2 (3)

Law (Romulan Military Regulations) 1 (2)

Personal Equipment (choose Specialization) 1 (2)

Planetside Survival (choose Specialization) 1 (2)

Shipboard Systems (choose Specialization) 2 (3)

Systems Engineering (choose Specialization) 1 (2)

Unarmed Combat (choose Specialization) 2 (3)

Vehicle Operations (Shuttle) 1 (2)

Command

Administration (Starship Administration) 1 (2)

Command (Starship Command) 1 (2)

Planetary Tactics (choose Specialization) 1 (2) OR Starship Tactics (choose Specialization) 1 (2)

Engineering

Engineering, Any (choose Specialization) 2 (3)

Physical Science, Any (choose Specialization) 1 (2)

Medical

First Aid (Combat Trauma) 1 (2)

Medical Science (choose Specialization) 2 (3)

Operations

Administration (choose Specialization) 1 (2)

Shipboard Systems (choose Specialization) 1 (2)

Systems Engineering (choose Specialization) 1 (2)

Science

Science, Any (choose Specialization) 2 (3)

Science, Any other (choose Specialization) 1 (2)

Security

Security (Security Systems) 2 (3)

Planetary Tactics (Small Unit) 1 (2)

Tactical

Starship Tactics (choose Specialization) 2 (3)

Systems Engineering (choose Tactical Station, Disruptors, Cloaking Device, or Deflector Shields) 1 (2)

Tal Diann

Administration (Romulan Military) 1 (2)

Security Clearance +3

Surveillance (choose Specialization) 1 (2)



COMMAND

The character showed a flair for command during his *Serona*, or someone with influence pulled some strings to get him a commission. At the Romulan War College, the character learned the basics of leading men and women into battle and conducting space warfare. He also gained a bit of first-hand knowledge about military politics.

ENGINEERING

During the character's *Serona*, she demonstrated some Engineering talent and picked up enough skills to pursue the engineering sciences as her chosen career. Or she simply desired a career in the military and wanted to put her engineering talents to work in service to the Praetor.

MEDICAL

The character showed a talent for medicine, and studied to become a doctor while attending the Romulan War College. He currently serves the Empire as a doctor in the Romulan military.

OPERATIONS

This is a catch-all for a variety of positions in the Romulan military, from operations management to flight control, from environmental systems to logistics planning. The character learned not only how things worked, but why.

SCIENCE

The Romulan fleet does not solely patrol space and conquer alien worlds; Romulans are as interested in stellar phenomena and learning about the



PROFESSION STAGES

Romulan Soldier: Universal Background, Early Life, *Serona*, Romulan War College, Tours of Duty.

Romulan Civilian: Universal Background, Early Life, *Serona*, Previous Experience

In addition to the standard stages of the Romulan Background History, there is a special stage just for *Tal Shiar* agents. It takes the place of the Romulan War College and Tours of Duty stages.

ROMULAN CIVILIANS

The Romulan Empire, unlike the Federation, demands service to the state from every citizen. A citizen of the Empire serves *D'era* by not only his willingness to do anything the Empire demands, but by his ability to do so. Romulus must count on each of its sons and daughters to give their utmost; to do less is to cheat the Empire and devalue *D'era*. The average Romulan citizen rigorously maintains the skills and talents that the Empire may one day call upon—some Federation economists believe that this diversion of resources to individual training and readiness is part of the reason that the Romulan economy produces less surplus wealth than its theoretical capacity.

Romulan civilian overlays such as the Intercessor, Scientist, and others are built to reflect this ethic of intense dedication and tireless maintenance of skills. In a sense, there are no Romulan civilians; every citizen is the equivalent of a Starfleet officer in his or her chosen field. Narrators may wish their series to reflect a less rigid social structure or, contrastingly, to emphasize the superiority of the Star Navy and other Romulan military personnel over their civilian counterparts. In such series, build civilian Romulans on 18 fewer Development Points (taken from the Overlays or Background History packages).

galaxy as the Federation. The character joined the military for the opportunity to explore space and study its mysteries.

SECURITY

While soldiers trained in intelligence safeguard against spies, security personnel serve as ground troops, military police, and security guards. At the War College, the character learned even more about weapons, ground warfare, and security precautions.

TACTICAL

Romulans who receive tactical training are experts in the art of interstellar warfare. Cadets learn, among other things, how to operate a cloaking device in conjunction with deflector shields to provide maximum protection, how to target sensitive areas of a starship, and planetary support tactics.

TAL DIANN

The character works for the *Tal Diann*, the military intelligence division. The *Tal Diann* tracks down dissidents and traitors within the ranks, along with keeping an eye out for Klingon or Federation spies. Members commonly serve as legates (a form of political officer) throughout the Romulan fleet.

Background History

A character is more than his heredity and profession. Every character is a collection of experiences, character traits, events, and calamities that shape his life and personality. To flesh out your character, to add these traits, the player makes a series of decisions that shape the character. Did she decide on a career in the military after her *Serona*? Did she serve a tour of duty on a backwater colony, or was she promoted to the elite Praetorian Guard? Each of these decisions affects the character's development.

The final stage of Romulan character creation is to take the character through the various stages of the Background History process. The steps involved depend on the type of character being created. Please consult the "Profession Stages" sidebar.

As with traditional Starfleet characters, the purpose of the Background History is to make the player think about the character's past during his life prior to the start of the series, and to obtain the skills and traits which reflect those activities and events. While Romulan society is fairly rigid and organized, there's still plenty of room for individual initiative and interests—and of course where and how a character was raised can differ greatly. A character who grew up in a scientific outpost on the edge of Romulan space will know different things than one who grew up on Romulus itself; a child who had a senator for a parent will look at things differently than one raised by reclusive scholars.

As in the core rulebook, each stage of the Romulan Background History includes a list of prebuilt "packages" representing specific types of backgrounds which a character might have experienced during that time of his life. Characters are not required to take these packages—they can simply spend the raw Development Points on any appropriate skill or advantage—but they provide a quick "shorthand" way of simulating many common backgrounds.

Unlike Federation characters, Romulans can learn any skills they want—all are useful in the service of the Empire. Ignore the icons indicating "inappropriate" skills in the core rulebook when creating Romulan characters.

Costs for all skills, edges, advantages, and the like are as listed in the *Star Trek: The Next Generation RPG* core rulebook on page 68.

UNIVERSAL BACKGROUND LIST

The lists on page 16 represent those advantages, disadvantages, and skills which a character may choose at any time during his Background History. This is not a separate stage along the Background, however; characters get no Development Points to spend.

RENOWN

All Romulans are expected to live up to an ideal—*D'era*, service to the Empire, expanding the boundaries of Romulan space. The more a Romulan emulates this ideal through his actions, the more likely someone will take notice. To reflect this reliance on deeds and reputation, Romulan characters depend on Renown.

In the *Star Trek: The Next Generation RPG* core rulebook, Renown is used to measure a character's fame and reputation. The higher a character's Renown, the more people have heard of his exploits. An officer with a high Renown has served the Empire well and exemplifies the Romulan ideal, while an officer with low Renown may find himself going nowhere, fast. Renown is divided into five aspects—Aggression, Discipline, Initiative, Openness, and Skill. Romulans place high value on Aggression, Discipline, and Skill—these qualities are recognized as the hallmarks of a “good” Romulan.

Throughout the Background History stage of character creation some options provide points of Renown, representing a number of factors, from opportunities offered because of heroic actions to strings pulled on your character's behalf. While creating a history for your character, you should have a clear picture of the type of character you want. Did your soldier rise quickly through the ranks thanks to favors provided by influential friends? Did your character come from a well known family, but choose to accept less-prestigious assignments? Did he come from common birth, only to rise to prominence because of his actions?

Certain packages at each stage of the Background History provide a number of Renown points. Similarly, certain traits provide additional Renown, such as Benefactor, Political Affiliation, and Commendation. These amounts should also be added to the character's Renown aspects. Keep track of any Renown awards; you'll need them later on under Finishing Touches (page 19), to determine how well known your character is by virtue of his past achievements. This will determine, among other things, the character's starting rank in the Romulan Military or *Tal Shiar*, and how many favors the character can call in.

EARLY LIFE

This stage represents the character's life from birth until he embarks on his *Serona* service. The skills, advantages, and disadvantages acquired at this stage are those learned as a child or young adult. They could simulate the character's lessons in school (particularly in subjects he liked), hobbies, things he was forced to learn by domineering parents, and so forth.

One of the most important indicators of success in Romulan society stems from the family. Members of a family with a strong history of meritorious service in the name of the Praetor are assumed to be somehow better. They have been inculcated in traditions of duty to Empire, nourished on stories of glorious forebears. They have extensive political and military connections, often relatives.

Yet common Romulans have less to fear from political vendettas and onerous obligations. Less is expected of these commoners, and they need not live up to the expectations of duty and honor. For them,

D'era is less an imperative. Through *D'era*, however, other, newer families can rise to greatness and fame.

One of the first questions you must ask yourself is, “From what part of society does my character originate?” Did you come from a privileged family, the scions of Romulan society, or did you have more humble origins?

If you choose to come from a prominent Romulan family, choose the family to which your character belongs. Each family package provides those skills, traits, and Renown representing the advantages of a privileged birth. Although it might be fun to play a rich, powerful Romulan, this might not fit the player's conception for his character. Similarly, the Narrator might want to limit his players to somewhat more mundane origins.

EXPLANATIONS OF EARLY LIFE PACKAGES

ACADEMIC UPBRINGING

The character was raised by parents who were scholars. They might have been university or Romulan Astrophysical Academy professors, consultants working for the Empire or for a vital industry, or something similar. Being around them gave the character exposure to a lot of interesting information and sparked his interest in a particular academic subject. However, it also made him arrogant about his intelligence.

COLONY UPBRINGING

The character was raised on a Romulan colony world. It was a tough life, but he survived and became stronger and tougher because of it. Now that he's older, he's planning to put his abilities to use on behalf of the Empire.

DISSIDENT UPBRINGING

The character's parents were dissidents, and he, like them, was constantly hiding certain activities from the authorities. He learned a lot about the seamier side of life, but now has a secret he must hide if he wishes to advance in normal Romulan society. (If the character is still a dissident as an adult, find some other disadvantage to take the place of Dark Secret if it is not appropriate.)

FAMOUS PARENTS

The character's parents were renowned scholars, politicians, or soldiers. That was a lot for the character to live up to, but thanks to some of the things he learned from being around his parents, it looks like he's got a chance to succeed.

MILITARY UPBRINGING

Although more prominent families have a long history of glorious service to the Romulan Empire, your character's family has a less prestigious history. Your parents were military officers, and you learned a thing or two from them. Unlike Starfleet, which has a policy of keeping families together, you remained on Romulus, eagerly awaiting news of your parents' exploits. They continue to look out for your career, and provide a bit of Renown.



WHAT IS D'ERA?

The Way of D'era frequently refers to *D'era*, the philosophy that forms the foundation of Romulan society. Believing themselves to be the children of the Vhorani, ancient beings who created the Romulan species at *Vorta Vor*, the Wellspring of Creation, the Romulans work to achieve their manifest destiny: to one day rule the Endless Sky, and take the place of their lost creators. While *D'era* explains Romulan arrogance and aggression, how does it apply to individuals?

Romulan society rewards those who embody the Romulan ideal, who follow the Path of *D'era*. By actively advancing the Romulan cause, a Romulan gains recognition, advancing in society (be it politically or militarily) and attracting influential friends. Romulan characters measure their conformity to *D'era* through the three Renown aspects viewed highly by Romulan society. Romulans who possess these qualities are considered paragons of Romulan virtue, to be respected and emulated.

Aggression: While the Aggression aspect typically reflects a willingness to use violence, or the threat of violence, to achieve an objective, the Romulans instead characterize this aspect as assertiveness. Romulans believe it is their destiny eventually to rule the other (obviously inferior) species, and to spread Romulan culture throughout the universe. Those who do not accept Romulan rule must be made to see the errors of their ways. A true Romulan does not give up in the face of resistance, but redoubles his efforts. Romulans regularly prod and test, searching for signs of weakness or indecision, whether negotiating with an alien leader or patrolling the Neutral Zone. Romulans with high Aggression Renown are seen as persistent and tenacious, though the violent connotations remain. Low Aggression conveys a sense of pacifism and a lack of resolve.

Discipline: Discipline reflects conformity to and consideration for the larger group. Romulans are expected to subsume their personal wants and desires to the needs of the Empire and the Romulan people. Without discipline, the Romulan Empire could not pursue its objective of bringing the teachings of the Vhorani to the less enlightened. Everyone must work together to follow the path of *D'era*. Loyalty is another facet of Discipline Renown, for without one you cannot have the other. Romulans with a high Discipline are viewed as loyal to the Empire, and willing to place the demands of *D'era* over their personal needs. Low Discipline connotes selfishness, self-aggrandizement, and disloyalty.

Skill: Skill covers personal skill, ability, competence, and resourcefulness. One cannot conquer the stars through tenacity and discipline alone. It takes skilled individuals to advance continually the Romulan cause, whether by developing a new technology or by commanding a warbird. The Vhorani made the Romulans strong and capable, and challenged them with a mighty task. Thus all Romulans must live up to their full potential. Romulan culture values accomplishment, rewarding those who excel while denouncing those who fail.

Throughout Background History development, certain options provide characters with Renown Points. Renown assigned during Early Life represents the affect of a character's heritage on his reputation; your character may be well known because of his parents, or his family's reputation (and may have to live up to the expectations of others). Renown given at other stages represents events that shaped your character. Perhaps you uncovered a dissident cell during your first Tour of Duty, and gained a reputation as a skilled investigator. Or you may have performed bravely during a raid on a Klingon outpost, impressing your superiors. Finally, certain advantages provide Renown. Having a prominent senator or admiral as an ally increases your character's reputation. The Narrator has more information on Renown and its affects in a Romulan series (see page 57).

NORMAL UPBRINGING

The safe, ordinary, traditional Romulan family. No major problems, but not much excitement, either. Romulan children on Romulus and Remus are encouraged to practice traditional martial arts in primary school; other planets vary this somewhat.

POLITICAL UPBRINGING

Someone in the character's family was a politician or diplomat—probably an important one. The character got to meet important people and witness important events. He also inherited his family's enemies. To counteract possible attempts on his life, he underwent a program designed to make him immune to the poison those enemies most often use.

UNDERWORLD BRAT

The character's parents were criminals, which is almost as bad as having dissidents for parents. But it taught the character a thing or two about the street. As an adult he has to hide his shady past (unless, of course, he's still a criminal, in which case another disadvantage may be substituted for Dark Secret, if appropriate).

THE SERONA

Upon reaching young adulthood, all Romulans are required to undergo a period of mandatory military service known as the *Serona*. During this time they receive a modest amount of basic military training and are then assigned to duties based on the Empire's needs, their skills, and their inclinations (in that order).

Unlike most Background History stages, this one is mostly pre-defined. The character automatically learns certain Skills (he has no choice; these skills are those the Romulan High Command dictates that all Romulans must learn during their *Serona*); only the "special training and missions" package can be chosen. For the most part, the *Serona* missions fulfill support roles; career military men usually don't think much of *Serona* "scruffs," as they're called, and use them to free "real soldiers" up for more important tasks. This is why, although a *Serona* enlistment lasts five years, a "scruff" learns very little in the way of useful skills.

Narrator's Note: Feel free to create additional packages to help steer characters toward the type of series you have in mind, or which better suit the characters which players have already created or proposed to you. The missions provided represent only six of a myriad of possible assignments.

EXPLANATION OF SERONA MISSION PACKAGES

DISSIDENT

After learning the basics of life in the Romulan military, the character became disaffected with the Romulan way of life and joined the dissident movement. He was fed a steady diet of revolutionary thought, and learned the techniques to avoid capture by the *Tal Shiar*.

ENGINEERING SUPPORT

Due to the character's talent with mechanical devices, he was assigned to a starship or starbase to assist the engineering staff. As a result he learned a thing or two about actual engineering.

MEDICAL SUPPORT

The character displayed a knack for the medical sciences, so he was assigned to a starship, starbase, or military hospital to assist the doctors. During his time there, he learned how to perform basic medical procedures.

PHYSICAL FITNESS

The character didn't display any particular talent or area of expertise, so he was shuffled from one job to another and given a lot of menial tasks. It didn't teach him much, but it got him into shape.

SECURITY

Although the Romulan military prides itself on the superior ability of its soldiers, it frequently sends young men and women to the front lines to serve as little more than cannon fodder. Your character managed to survive several years maintaining a garrison on a colony world, policing an unruly protectorate, or guarding a military installation.

STELLAR CARTOGRAPHY

The character was assigned to a stellar cartography mission to help map the Endless Sky.

ROMULAN WAR COLLEGE

What Starfleet Academy is to the citizens of the Federation, the Romulan War College (or, to give its proper name, the Military Rhetor of the Romulan Star Empire) is to Imperial citizens. All good Romulans want their children to grow up and attend the War College, since only the best of the best can gain admission. Graduating from the War College is a sure ticket not only to a career in the Romulan military, but to social prestige and, often, a life in the political arena after the graduate's military career has been completed.

The War College itself is located on the world of Devorren, which was occupied by the Romulans centuries ago and has remained in their hands ever since. In contrast to the lovely, temperate climate of Romulus, Devorren is a cold, harsh world with little vegetation. Its surface is frequently swept by strong winds and storms. Since their environment offers no real distractions, the War College students are able to devote themselves entirely to their studies.

The War College's course of study lasts for four grueling years. Actually, students only spend three years at the War College itself; the fourth year is a year of "on-the-job training" served aboard an actual starship. The first year is devoted mainly to getting the students into fighting shape and teaching them basic military doctrine. This is done primarily by putting the students through an intense physical fitness regimen.

This training includes long runs in the frigid Devorren weather, unarmed combat training (including "full contact" competitions which have killed or maimed more than one student), and feeding the students about two thirds of the calories they really need so as to make them lean and mean. Classes in military procedures, regulations, and standards give the students an occasional break.

The second year is when the students really begin to learn how to be true Romulan military personnel. They are introduced to the basics of the Romulan military, including its equipment, standard strategic and tactical doctrines, ships, and so forth. They also do a "rotation" among classes devoted to each of the major areas of operation aboard a starship, so as to expose them to a broad-based, if shallow, knowl-

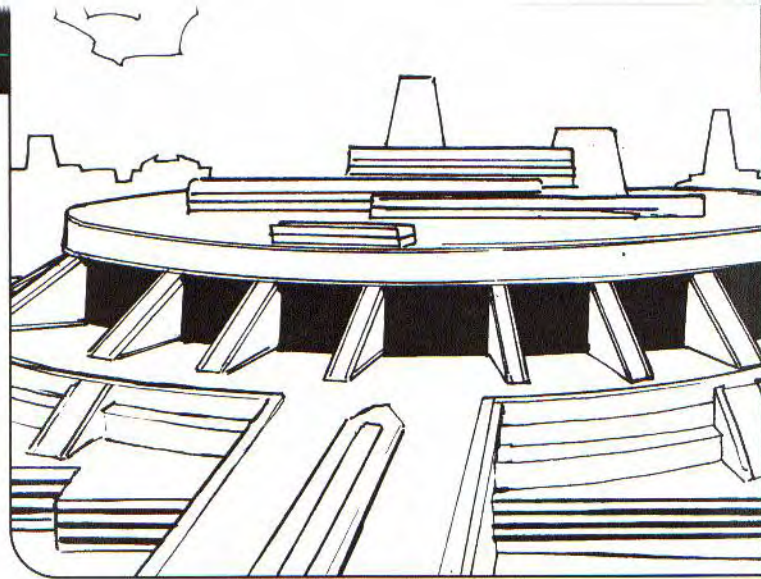

edge of what goes on aboard such a ship and how the ship itself operates.

The third year is where the real learning takes place. At this time students finally begin to specialize in whatever subject interests them—or, in some cases, which the Empire thinks they should study. They learn this subject inside and out, sitting through hours-long courses for up to half a day at a time, with only short breaks for meals. Students are expected to learn their lessons well; anyone who doesn't maintain an acceptable record is summarily ejected from the school—usually after undergoing mind alteration so that he cannot remember anything he saw or learned at the War College.

The fourth year, as mentioned above, is served aboard a Romulan starship. The student receives the rank of "Junior *Uhlan*" and is pretty much at the mercy of all of the actual military personnel—he can be ordered to do just about anything by any crewman.

The Empire has no intention of wasting well made tools, however, so overt abuse is not permitted and the student generally learns a great deal during this year. Assuming all goes well, he will usually be posted to that same ship after graduating. If all does not go well, or his performance is in any way unsatisfactory, ejection and mindwiping are the standard procedures (assuming he survives the year).

EXPLANATIONS OF ROMULAN WAR COLLEGE TRAINING PACKAGES

ADVANCED ENGINEERING RESEARCH

The character learns advanced applications of the engineering sciences, in the process helping to push forward the boundaries of Romulan technological achievement.

ADVANCED STRATEGIC COMMAND SCHOOL

The character learns in detail how the Romulan fleets are supplied, organized, and used in pursuit of military objectives. Many ASCS "graduates" go on to become wargames experts and military planners.

ADVANCED WARBIRD TACTICAL COMBAT TRAINING

A favorite of students who hope one day to command a starship, advanced tactical training teaches all the tips and tricks about starship combat which

MAN

CHARACTER CREATION

decades of Romulan starship commanders have learned through cold, hard experience.

ELITE UNIT TRAINING

The character receives special training in forms of armed and unarmed combat, taught by elite soldiers such as Praetorian Guardsmen, the Zirphañ Legion, or the Star Navy's *D'asa* Group. (If the character does not have a Primitive Weapon Skill, he may, at the Narrator's option, choose some other appropriate advantage in place of Weapon Master.)

EXPLORATION TRAINING

Although it does not consider exploration its primary mission, the Romulan Star Navy does play a significant role in exploring Romulan space. Some of its ships and members are specifically designed and trained for such missions.

INTELLIGENCE TRAINING

The character served an "internship" with the *Tal Shiar*. Most such characters go on to counterintelligence tours of duty.

PREVIOUS EXPERIENCE

Nonmilitary characters, such as intercessors, senatorial aides, and merchants, do not attend the Romulan War College. After the *Serona*, your charac-

PREVIOUS EXPERIENCE

For every year the character lived after his *Serona* and prior to the start of the series, spend 2 points on the skills and traits listed on the Universal Background table.

ter musters out of the military and is free to pursue whatever career interests him. He may take his meager savings and open a small stall in Val'danadex Trel, travel the Empire as a merchant trader, or attend a university and find a job in the government.

For every year of the character's life from *Serona* to the beginning of play, the player receives 2 Development Points to spend on the Universal Background list (page 18).

Narrators should limit civilian characters to an equivalent number of points, to maintain the balance among characters. This includes points spent by military characters on the Romulan War College and Tours of Duty.

Example: A group of players wants to play a dissident campaign, working to reunify the Romulan people with their Vulcan cousins. The Narrator decides to limit each player to 10 points, representing five years' time.

Example: A group of players wants to portray the crew of a warbird. Each attends the Romulan War College and undergoes one Tour of Duty, for a total of nine years (four at the War College, five on Tour of Duty). One player wants to play a civilian joining the crew, a senatorial aide. This player should spend 18 points under Previous Experience.

TOUR OF DUTY

This stage of the Background History represents the character's first tour of duty aboard a Romulan ship (or in some other post) as a full-fledged member of the Romulan Star Navy. He may, if the player wishes and the Narrator permits, have served additional tours of duty prior to the beginning of the game. Unlike Starfleet, which assigns its officers to a particular posting for a varying amount of time, a tour of duty in the Romulan military lasts five years, after which the character can reenlist.

TAL SHIAR BACKGROUND

Those who are recruited by the *Tal Shiar* follow a somewhat different path. They do not attend the Romulan War College or go on Tours of Duty. Instead, they are sent to special *Tal Shiar* training schools where they receive in-depth instruction (and indoctrination) in the methods of Romulan espionage. Then they are sent on various missions on behalf of the *Tal Shiar*—anything ranging from teaching new recruits (or providing basic instruction to Romulan Navy enlistees), to intelligence analysis, to undercover operations.

Players playing *Tal Shiar* agents should choose one package from those available for their course of study at *Tal Shiar* headquarters. Afterward, choose another package for the character's first Tour of Duty.

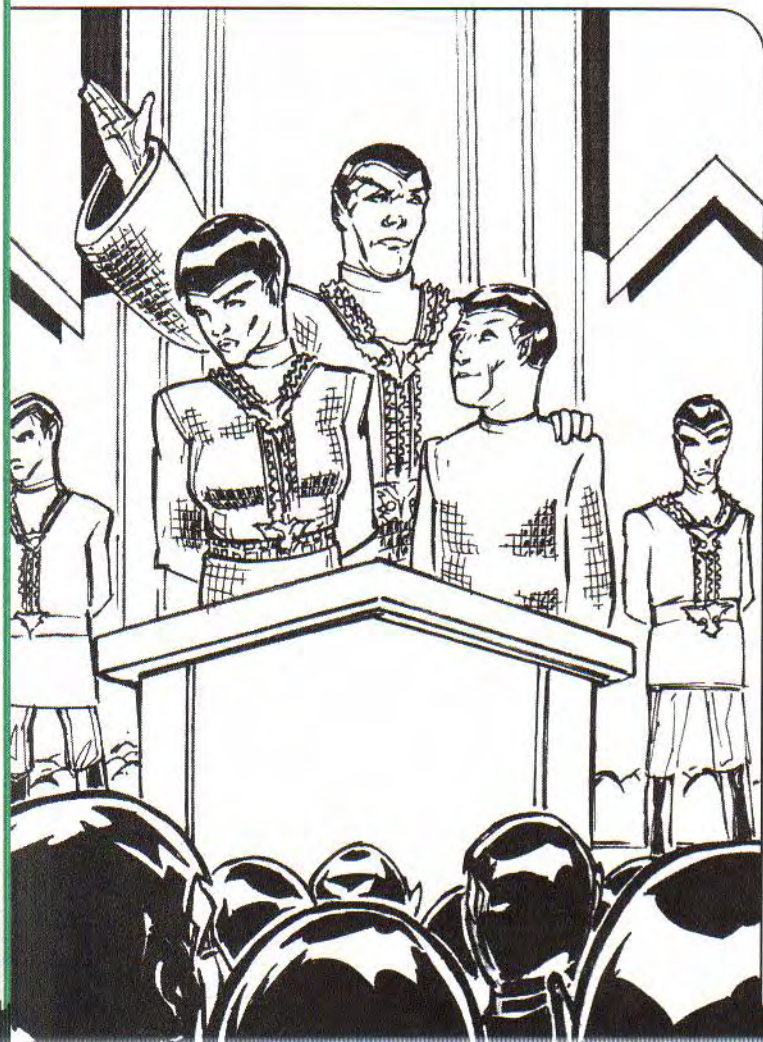

The character may, if the player wishes and the Narrator permits, have served additional tours of duty prior to the beginning of the game.

FINISHING TOUCHES

RENOWN

Total the Renown awards from the various packages selected during Background History. This is your character's starting Renown.

Example: *At the end of character creation, Subcommander T'ret's player calculates his Renown. He has Aggression 10, Discipline 10, and Skill 5, for a total Renown of 25.*

GLORY

Glory measures a character's ability to trade on his reputation, to make things happen, both in the Romulan Empire and in the game. Spending Glory points, a player character can call in a favor from a cohort in the Romulan High Command, request the support of a powerful benefactor, or perhaps even solicit the aid of the Praetor or *Tal Shiar*.

When a character wishes to call upon external forces to affect game play, the player must spend points of Glory. When used in this way, any number of Glory points may be spent at a given time. (The Narrator has more information on this in the chapter entitled "Romulan Series," page 51).

Like Courage, Glory can also be used to affect Test Results. Used in this way, once per round a player can spend up to 4 Glory points to improve a single Skill Test. Each Glory Point spent increases the Test Result by one.

To find your starting Glory, calculate your Renown in Aggression, Discipline, and Skill. Thus, Glory depends on your character's reputation as a paragon of *D'era*. Those with little reputation have little Glory to trade on. Those with high Renown can call in favors from across Romulan society.

RANK

To find your character's starting rank, compare the character's total number of points under Aggression, Discipline, and Skill on the Renown and Rank Table; be sure to include Renown from any advantages the character possesses. This is especially important to characters in the military, politics, or *Tal Shiar*; those outside these fields do not gain any tangible benefits from high Renown.

Reputation can never take the place of deeds. A Romulan soldier may receive his position because his uncle is a decorated admiral, but if he is unable to perform his duties he'll soon lose that position. At best, a good reputation gives you the opportunity to prove yourself. Those unqualified to hold their position eventually begin accumulating negative Renown and lose their standing. Deeds provide the surest route to success and glory.

During the course of play, a character's Renown will go up and down based on his actions. More so than skill levels, a Romulan's Renown determines his standing in Romulan society. Although a character can earn Renown without making a Skill Test, this shouldn't happen often. Most actions warranting a

RENOWN AND RANK

| Renown | Military | Politics* | Tal Shiar |
|--------|---------------|------------|---------------|
| 0 | Uhlan | File Clerk | Uhlan |
| 10 | Sublieutenant | Assistant | Sublieutenant |
| 15 | Lieutenant | Aide | Lieutenant |
| 25 | Subcommander | Deputy | Captain |
| 50 | Commander | Secretary | Major |
| 75 | Centurion | Chief | Colonel |
| 105 | Admiral | Senator | General |

*Ranks for politicians indicate their position within the government. They are usually attached to some function, such as Secretary for Colonial Affairs or Chief of Staff.

Renown award will require some sort of Skill Test. (See the Renown rules on page 57).

Example: *T'ret's Renown in Aggression, Discipline, and Skill totals 25 points. Consulting the rank table, his player discovers T'ret is a Subcommander in the Romulan Star Navy.*

COURAGE POINTS

Unlike Starfleet characters, Romulan characters do not receive the benefit of Courage Points. They may use Glory Points to affect the outcome of tests and die rolls.

WOUND LEVELS

See the *Star Trek: The Next Generation RPG* core rulebook, page 77, for the rules on calculating Wound Levels.



UNIVERSAL BACKGROUND LIST

ADVANTAGES

- | | | |
|-----------------------|-----------------------------|----------------------|
| Athletic Ability (+2) | Famous Incident (varies) | Sexy (+2) |
| Benefactor (+2 to +4) | Favor Owed (+1) | Shrewd (+1) |
| Bold (+1) | Hereditary Benefit (varies) | Strong Will (+2) |
| Cohorts (+2 to +5) | Medical Remedy (varies) | Tolerance (+2 to +4) |
| Contact (+1 to +3) | Quick-draw (+2) | |
| Curious (+1) | Resolute (+3) | |

DISADVANTAGES

- | | | |
|---------------------------------|--|---|
| Argumentative (-1) | Intolerant (-1 to -3) | deafness (-1) |
| Chronic Pain (-2) | Medical Problem (-1 to -3) | Poor Sight (if later in life, due to injury, radiation, or increasing blindness) (-2) |
| Code of Honor (-2 to -5) | Obligation (-1 to -3) | Power-hungry (-1 to -2) |
| Dark Secret (-1 to -3) | Obsessive Tendencies (-3) | Rival (-1 to -3) |
| Dark Secret Revealed (-2 to -4) | Pacifism (-1 to -5) | Shamed (varies) |
| Dependent (-2) | Phobia (-2 to -5) | Sworn Enemy (-1 to -3) |
| Fanatic (-2 to -3) | Physically Impaired (-1 to -3) | Vengeful (-1 to -2) |
| Greedy (-1) | Poor Chemoreception (if later in life, due to disease or chemical exposure) (-1) | Watched (-2)Skills |
| Hides Emotions (-2) | Poor Hearing (if later in life, due to trauma or increasing | |
| Hypochondria (-1) | | |
| Imprudent (-1) | | |

SKILLS

- | | | |
|---------------------|--------------------|---------------------|
| Acrobatics | Engineering, Any | Planetside Survival |
| Administration | Fast Talk | Politics |
| Artistic Expression | First Aid | Primitive Weaponry |
| Athletics | Gaming | Science, Any |
| Bargain | History | Search |
| Charm | Intimidation | Sleight of Hand |
| Computer | Language | Stealth |
| Culture | Law | Surveillance |
| Demolitions | Mediation | Unarmed Combat |
| Diplomacy | Merchant | Vehicle Operation |
| Disguise | Personal Equipment | World Knowledge |
| Dodge | Persuasion | |
| Energy Weapon | Planetary Tactics | |

EARLY LIFE HISTORY



ATTRIBUTES

Any

ADVANTAGES

Alertness (+2)
Alien Upbringing (+1)
Ambidexterity (+2)
Double-jointed (+2)
Eidetic Memory (+3)
Engineering Aptitude (+3)
Excellent Balance (+1)
Excellent Chemoreception (+2)

Excellent Hearing (+2)
Excellent Metabolism (+1)
Excellent Sight (+2)
High Pain Threshold (+2)
Innovative (+1)
Language Ability (+2)
Mathematical Ability (+3)
Mixed Species Heritage (+6)

Night Vision (+2)
Peripheral Vision (+1)
Rapid Healing (+1)
Sense of Direction (+1)
Sense of Time (+2)
Tactical Genius (+3)
Telepathic Resistance (+4)
Toughness (+2)

DISADVANTAGES

Bloodlust (-2)
Low Pain Threshold (-2)
Shamed (varies)

Slow Healing (-2)
Weak Will (-2)
Weakness (-2)

Zero-G Intolerance (-2)

SKILLS

Academic Skills

Culture
History
Language
Law
Sciences, All
World Knowledge

Survival Skills

Dodge
Energy Weapon
First Aid
Primitive Weaponry
Stealth
Unarmed Combat

Other Skills

Animal Handling
Psionic Skill (if applicable)
Streetwise

EARLY LIFE HISTORY

 The character receives 6 Development Points to spend during Early Life.

EARLY LIFE PACKAGES

Common Early Life Packages (each costs 6 Development Points)

Academic Upbringing: +1 to Logic Edge, one Academic Skill (see box) (choose Specialization) 1 (2), Computer (Research) 1 (2), Arrogant -1

Colony Upbringing: One additional Survival Skill (see box) 1 (2), Planetside Survival (choose Specialization) 1 (2)

Dissident Upbringing: Stealth (choose Specialization) 1 (2), Streetwise (Locate Information OR Locate Contraband) 1 (2), Alertness +2, Dark Secret -2

Famous Parents: 2 Skill Renown, one additional Intellect Skill at 1 (2), Benefactor (your parents) +2

Military Brat: Administration (Romulan Military Bureaucracy) 1 (2), World Knowledge (choose Specialization) 1 (2), Contact (Romulan military) +1, Strength +1 OR Dexterity +1, Rival (in the military) -2

Normal Upbringing: Dexterity +1 OR Reaction +1, Unarmed Combat (must be a Romulan style) 1 (2), choose 2 points worth of Advantages

Political Upbringing: Diplomacy (with Specialization reflecting your parents' career) at 1 (2), Favor Owed +1, Tolerance +2 (poison or substance of character's choice)

Underworld Brat: +1 Perception OR Willpower Edge, Energy Weapon (Disruptor) 1 (2) OR Primitive Weaponry (choose specialization) 1 (2), Streetwise (choose Specialization) 1 (2), Dark Secret -1

NOBLE FAMILY PACKAGES

Noble Family Early Life Packages (each costs 6 Development Points)

Barel: 10 Skill Renown, Politics (Maneuver) 1 (2), -2 points Family Disadvantage (see box below)

Gaius: 8 Skill Renown, Contact +1, Politics (Intelligence) 1 (2), Rival -2

Kassus: 6 Discipline Renown, Command (Warbird) 1 (2)

Kayton: 10 Discipline Renown, Primitive Weaponry (Choose from Vrelnec, Lirash, or Kailune) 1 (2), Favor Owed +1, Code of Honor (Romulan) -3

Marrus: 6 Skill Renown, Merchant (choose Specialization) 1 (2) OR Science, Any (choose Specialization) 1 (2)

Qellar: 4 Discipline Renown, Espionage (choose Specialization) 1 (2), Intimidation (Cross Examination) 1 (2), -2 points Family Disadvantage (see box below)

Tela: 8 Skill Renown, Hereditary Benefit +3, -1 point Family Disadvantage (see box below)

Terik: 6 Aggression Renown, Energy Weapon (Disruptor) 1 (2), +1 Strength Edge OR +1 Vitality Edge, Impulsive -1

FAMILY DISADVANTAGE TABLE

| | | |
|---------------------------------|--------------------------|------------------------|
| Arrogant -1 | Fanatic (-2 to -3) | Sworn Enemy (-1 to -3) |
| Code of Honor (-2 to -5) | Obligation (-1 to -3) | Watched (-2) |
| Dark Secret (-1 to -3) | Rival (-1 to -3) | |
| Dark Secret Revealed (-2 to -4) | Species Enemy (-3 to -5) | |

 *The character gets 9 Development Points to spend during his Serona.*

BASIC TRAINING

All Romulan characters must buy these Skills during their Serona Background History stage:

Energy Weapon (Disruptor) 1 (2)

Law (Romulan Military Regulations) 1 (2)

Unarmed Combat (Romulan Navy Martial Arts, basic maneuvers) 1 (2)

All Romulan characters must buy this Disadvantage during their Serona Background History stage:

Obligation -3 (to Romulan military; character is subject to being called back to service at any time).

NARRATOR'S NOTE

If the character already has one of these Skills, at your option he may be sent for "alternate" training—in game terms, be allowed to buy some other Skill. However, the additional Skill should relate to his assigned mission.

SERONA MISSION PACKAGES

Serona Mission Packages (each costs 3 Development Points)

Dissident: Espionage (Counterintelligence) 1 (2)

Engineering Support: Engineering, Any 1 (2)

Medical Support: Medical Science 1 (2)

Physical Fitness: +1 to any physical Attribute, +1 to any physical Edge

Security: Energy Weapon (Disruptor) 1 (2) OR Dodge 1

Stellar Cartography: Space Science (Stellar Cartography) 1 (2)

ROMULAN WAR COLLEGE

 The character receives 8 Development Points to spend during Romulan War College Life.

ATTRIBUTES AND EDGES

Any

ADVANTAGES

Alertness (+2)

High Pain Threshold (+2)

Mathematical Ability (+3)

Commendation (+1 to +3)

Innovative (+1)

Tactical Genius (+3)

Engineering Aptitude (+3)

Language Ability (+2)

DISADVANTAGES

Dark Secret Revealed (-2 to -4)

Watched (-2)

Zero-G Intolerance (-2)

SKILLS

Behavior Modification

Psionic Skills (if applicable)

Starship Tactics

Command

Security

Strategic Operations

Heavy Weapons

Shipboard Systems

WAR COLLEGE PACKAGES

Romulan War College Specialized Training Packages (each costs 8 Development Points)

Advanced Engineering Research: Engineering, Any (choose Specialization) 1 (2), Science, Any (choose Specialization) 1 (2), +1 to Intellect

Advanced Strategic Command School: 4 Discipline Renown, Administration (Logistics) 1 (2), Strategic Operations (choose Specialization) 1 (2)

Advanced Warbird Tactical Combat Training: 6 Discipline Renown, Starship Tactics (choose two Specializations) 1 (2) and (2), Bold +1

Elite Unit Training: Planetary Tactics (Small Unit) 1 (2), Unarmed Combat 1 (2) OR Primitive Weaponry 1 (2), Weapon Master +2 OR 4 Aggression Renown

Exploration Training: Planetary Science (choose Specialization) 1 (2), Space Science (choose Specialization) 1 (2), Zero-G Training +2 OR 4 Skill Renown

Intelligence Training: Behavior Modification (choose Specialization) 1 (2), Espionage (choose Specialization) 1 (2), Security (choose Specialization) 1 (2) Obligation -1 (to *Tal Shiar*)

ATTRIBUTES AND EDGES

Perception

Willpower

ADVANTAGES

Alertness (+2)

Commendation (+1 to +3)

Innovative (+1)

DISADVANTAGES

Bloodlust (-2) (almost always tied to Vengeful)

Chronic Pain (-2)

Low Pain Threshold (-2)

Medical Problem (-1 to -3)

Physically Impaired (-1 to -2)

Poor Chemoreception (-1)

Poor Hearing (-1)

Poor Sight (-2)

Slow Healing (-2)

Vengeful (-1 to -2)

Weakness (-2)

SKILLS

Administration

Command

Espionage

Heavy Weapons

Planetary Tactics

Psionic Skills (if applicable)

Security

Shipboard Systems

Starship Tactics

Strategic Operations

TOUR PACKAGES

The character receives 10 Development Points to spend during Romulan Tour of Duty.

Tours of Duty Packages (cost 10 Development Points each)

Counterintelligence: 2 Renown (Discipline OR Skill), Espionage (Counterintelligence and one additional Specialization) 1 (2) and (2), Intimidation (choose Specialization) 1 (2), Commendation +1, Contact (an informer) +1

Deep Space Exploration Mission: Planetary Sciences (choose Specialization) 1 (2), Space Sciences (Stellar Cartography and one additional Specialization) 1 (2) and (2), Bold +1, Species Friend +2

Diplomatic Mission: 6 Skill Renown, Diplomacy (choose Specialization) 1 (2), one Language at 1, Contact +1

Dissident*: Espionage (choose Specialization) 1 (2), Security (Dissident Operations) 2 (3), Stealth (Hide) 1 (2), Streetwise (Locate Contraband OR Locate Information) 1 (2), Contact (military OR dissident) +1, Dark Secret -3 and Fanatic -3 OR Watched -2 and Dark Secret Revealed -4

Garrison: Gaming (choose Specialization) 1 (2), Security (Law Enforcement) 1 (2), Dodge 1, +1 Edge (Strength, Vitality, Dexterity, Reaction, Logic, Perception)

Neutral Zone Patrol/Hostile Frontier Defense Mission: 6 Renown (Aggression, Discipline, OR Skill), Starship Tactics (choose two Specializations) 1 (2) and (2), Strategic Operations (Neutral Zone Strategies or other Specialization) 1 (2)

Praetorian Guard: 10 Skill Renown, Planetary Tactics (Small Unit) 1 (2), Primitive Weaponry (*Lirash*) 1 (2), Contact +1, Code of Honor: Personal Code -2

Romulan High Command: 4 Discipline Renown, Administration (Romulan Navy) 1 (2), Law (Romulan Military Regulations) 1 (2) OR Strategic Operations (Fleet Operations) 1 (2), Contact +2

Skirmish: 6 Renown (Aggression, Discipline, OR Skill), Energy Weapon (Disruptor) 1 (2), Planetary Tactics (Guerilla Warfare) 1 (2) OR Starship Tactics (Planetary Support) 1 (2), Famous Incident +1

Starbase Mission: Administration (Logistics) 1 (2), Engineering (Environmental Systems) 1 (2), Vehicle Operation (Shuttlecraft) 1 (2), Contact +1

War College Instruction: Any Academic Skill (with two Specializations) 1 (2) and (2) (see box under Early Life History), Intimidation (Bluster) 1 (2), Law (Romulan Military Regulations) 1 (2)

***Dissident:** While serving in the Romulan guard, the character became disillusioned with the Romulan way of life. He found others who shared his feelings, and he joined the dissident movement.

TAL SHIAR

TAL SHIAR PACKAGES

The character receives 9 Development Points to spend during Tal Shiar Life.

Counterintelligence: 4 Renown (Skill), Espionage (Counterintelligence) 1 (2), Intimidation (choose Specialization) 1 (2)
OR Surveillance (choose Specialization) 1 (2), Stealth (choose Specialization) 1 (2), Fanatic (devotion to protecting Empire from spies) -2

Cryptoanalysis: Espionage (Cryptography) 1 (2), Physical Sciences (Mathematics) 1 (2), one Language of player's choice at 1

Intelligence/Traffic Analysis: Espionage (Intelligence Analysis OR Traffic Analysis) 2 (3), Starship Tactics (choose Specialization) 1 (2)

Interrogation: 2 Renown (Skill), Behavior Modification (choose Specialization) 1 (2), Intimidation (choose Specialization) 1 (2), High Pain Threshold +2

Shipboard Intelligence Officer: Security (Security Systems and one additional Specialization) 1 (2) and (2), Shipboard Systems (Tactical and one additional Specialization) 1 (2) and (2), Favor Owed +1

Strategic Analysis: Computer (Simulation/Modeling) 1 (2), Starship Tactics (Starfleet, Taurhai, or other) 1 (2), Strategic Operations (choose Specialization) 1 (2)

Undercover Operations: 4 Skill Renown (secret, of course), Artistic Expression (Acting) 1 (2), Culture (Vulcan or other Specialization) 1 (2), Disguise (Human or other Specialization) 1 (2), Espionage (Covert Communications) 1 (2), Fanatic -3, Sworn Enemy -2 (enemy counterintelligence agents)

War College Instructor: Any Academic Skill (with two Specializations) 1 (2) and (2) (see box under Early Life History), Administration (choose appropriate Specialization) 1 (2), 2 Contacts +1

ATTRIBUTES AND EDGES

Any

ADVANTAGES

| | | |
|--------------------------|---------------------------|----------------------|
| Alertness (+2) | Innovative (+1) | Tactical Genius (+3) |
| Commendation (+1 to +3) | Language Ability (+2) | |
| High Pain Threshold (+2) | Mathematical Ability (+3) | |

DISADVANTAGES

| | | |
|---|--------------------------------|------------------------|
| Bloodlust (-2) (almost always tied to Vengeful) | Low Pain Threshold (-2) | Poor Sight (-2) |
| Chronic Pain (-2) | Medical Problem (-1 to -3) | Rival (-1 to -3) |
| Dark Secret (-1 to -3) | Physically Impaired (-1 to -2) | Slow Healing (-2) |
| Fanatic (-2 to -3) | Poor Chemoreception (-1) | Sworn Enemy (-1 to -3) |
| | Poor Hearing (-1) | Vengeful (-1 to -2) |

SKILLS

| | | |
|-----------------------|-------------------------------|----------------------|
| Administration | Planetary Tactics | Starship Tactics |
| Behavior Modification | Psonic Skills (if applicable) | Strategic Operations |
| Command | Security | |
| Heavy Weapons | Shipboard Systems | |

ROMULAN TRAITS



Romulans tend to be as skilled as their Federation counterparts—like Starfleet, Romulans place a high value on Skill Renown. A competent Romulan advances through the ranks and earns honor and glory for himself and for the Empire; an unskilled one is likely to get himself killed, or, at the very least, transferred off the ship so he can antagonize some other commander with his incompetence.

As you read this section, please keep in mind that most statements about how Romulans regard or use certain skills are generalizations. They don't have to apply to a particular character if you don't want them to; even in a relatively rigid society such as the Romulan Star Empire, there is room for many different viewpoints and practices regarding such matters.

Romulan Skills

Almost all Romulan characters should know the skills listed in the accompanying box, which are all a part of either the Romulan Template or each of the Romulan Overlays described in the previous chapter.

These skills and specializations represent the basic information and abilities which anyone growing up on Romulus, or as a Romulan, would probably learn. A Romulan character who for some reason was not exposed to Romulan culture as he grew up will not have these skills. Such a character probably should not use the Romulan Overlays; instead, he should pick up the basic skills common to the culture to which he was exposed while growing up (typically those provided in the basic Overlays described in the core rulebook).

If the character has made a special effort to train himself in Romulan culture, however, he may know both sets of skills. On the other hand, non-Romulans raised in Romulan society should have the skills listed here.

When choosing specializations for a Romulan character, keep in mind that creating a Romulan character requires a different perspective—the Romulan perspective. The character hasn't followed the typical Starfleet training program common to most characters in the *Star Trek: The Next Generation Roleplaying Game*. For example, the "default" (or standard) specialization for Starship Tactics among Romulan starship officers will be Starship Tactics (Romulan)—the basic tactics they learn at the Romulan War College. If they want to learn about, say, Starfleet tactics or Taurhai tactics, they can select another specialization.

In short, a character trained on Romulus is going to have a significantly different set of skill specializations than the "standard Starfleet character." Some of the skills which are likely to be affected by this include Administration, Culture, History, Law, Planetary Sciences, Planetary Tactics, Starship Tactics, Strategic Operations, and World Knowledge.

ROMULAN DEFAULT SKILLS

Culture (Romulan) 2 (3)

History (Romulan) 1 (2)

Language

Romulan 2

Law (Romulan) 1 (2)

World Knowledge (Romulus) 1 (2)



COMMAND SKILLS

ADMINISTRATION

This skill is a common one among Romulan characters. Romulan society is rigid and stratified, and much of it is organized around the goal of supporting the military. Many Romulans make personal sacrifices so that public funds can be devoted to the Empire's defense and security. Therefore, it's important to make sure that all aspects of society function as efficiently as possible and that the military receives the maximum benefit from the extra funds.

After all, the Romulans would be far less sanguine about the sacrifices they are called on to make if the funds were spent frivolously. As a result, few Romulan politicians, bureaucrats, or leaders lack this skill.

BEHAVIOR MODIFICATION

Starfleet officers may be "above" such things, but Romulans lack the squeamishness of their Federation counterparts when it comes to conducting brutal interrogations or brainwashing captives. They won't usually go so far as to engage in outright torture, but they can make interrogations extremely unpleasant. Romulan psychologists have become masters at breaking prisoners and "rebuilding" their minds to make them servants of the Empire.

The efficacy of Romulan brainwashing techniques can be seen in an incident which took place in the year 2367. Romulan forces mentally reprogrammed Lt. Commander Geordi La Forge of the *Enterprise-D* to, among other things, attempt an assassination of a Klingon governor. The plot was subsequently uncovered and foiled, but the fact remains that Romulan mental reprogramming methods and psychological tactics are quite powerful.



COMMAND

Because Romulans are accustomed to a stratified society where the penalties for disobedience can be severe, they are usually quick to obey orders from anyone authorized to give them—or even someone who can make it seem that he has such authorization. At the Narrator's option, Command rolls made against Romulans may receive a +1 to the Test Result.

ESPIONAGE

Needless to say, this skill is paramount for members of the *Tal Shiar*, and most members know it at high levels of skill. Typically their primary specialization is Intelligence Techniques (*Tal Shiar*), but Covert Communications, Counterintelligence, and Intelligence Techniques (Federation or Taurhai) are also common.

Many Romulan dissidents also know some Espionage techniques, though they are rarely as skilled at them as *Tal Shiar* agents—their learning is more piecemeal, rather than the advanced, formal espionage education which *Tal Shiar* agents receive. This is usually bought as the specialization Intelligence Techniques (*Tal Shiar*) and used to foil attempts by the infamous Romulan security agency to uncover or thwart dissident activities.

OBSERVATION (NEW SPECIALIZATION)

This is the ability to observe your surroundings, such as noticing a combination as it's being entered, recognizing furtive gestures, or catching snippets of conversations.

OPERATIONS SKILLS

Operations skills usually depend heavily on consoles and similar input devices (though voice commands may also be available). Romulan interfaces are significantly different from those used by Starfleet; not only the language used, but the general arrangement and logic behind that arrangement, are far different. For this reason, when Romulans attempt to use unfamiliar equipment, such as Starfleet equipment, or vice-versa, they should suffer an increase of one step in the Difficulty for all Operations Skill Tests (for example, a Moderate task becomes Challenging); the exact target number for the Test should be the lowest one in the higher category (thus, Challenging (9), to use the above example). There may also be difficulties when attempting to read the "keys" or read-outs on other species' equipment, though modern translation technology usually prevents this from being too much of a problem ("Computer, please state the answer in Romulan").

A character who has an appropriate specialization (such as Shipboard Systems (Starfleet Systems)) does not suffer a Difficulty increase. Such a specialization also provides a character with the ability to read the alien language on an interface, but not to understand or read its output.

ENGINEERING, PROPULSION

As described in *The Romulans*, "Chapter Five: The Tools of Conquest," Romulan starships use an arti-

cial quantum singularity drive. As a result, virtually every engineer in the Romulan Star Navy knows a particular specialization for Propulsion Engineering, Artificial Quantum Singularity Drive.

QUANTUM SINGULARITY DRIVE (NEW SPECIALIZATION)

While Starfleet officers and Klingon warriors (among others) employ the warp drive to achieve faster-than-light travel, the Romulans use a quantum singularity drive. An artificial quantum singularity is a microscopic black hole. While this produces enormous amounts of energy, it can also be dangerous. Once activated, an artificial quantum singularity drive cannot be deactivated—that would create a full-fledged black hole.

A similar result occurs if the energy fields used to keep the artificial quantum singularity “safe” are damaged. Romulan engineers learn how to keep a quantum singularity drive functioning properly, as well as how to repair them.

ENGINEERING, SYSTEMS

CLOAKING DEVICE (NEW SPECIALIZATION)

This specialization is frequently found among Romulan engineers and tactical officers, since Romulan ships often rely heavily on their cloaking devices to prevent detection. This specialization covers maintenance and repair of cloaking device technology.

If it is necessary to work on a cloaking device while it is in operation, there is a chance that this will temporarily eliminate the effects of the cloak (as described on page 216 of the core rulebook), thus allowing a nearby ship to detect the fluctuations in the cloak and know the cloaked ship’s location. This requires a Challenging (11) Shipboard Systems (Sensors) Test.

If the character performing the work fails his Systems Engineering (Cloaking Device) Test, the possibility of sensing the cloaked ship is reduced to Challenging (9). If the engineer suffers a Dramatic Failure, the cloak immediately disengages. However, any such fluctuation or disengagement lasts only for one round, so the enemy ship has to act quickly to take advantage of it.

SECURITY

This skill is pretty much a requirement for all *Tal Shiar* officers, since they are responsible, in part, for Romulan internal security in addition to their standard intelligence gathering duties. Law Enforcement is their typical specialization.

DISSIDENT OPERATIONS (NEW SPECIALIZATION):

Many Romulan dissidents possess the Security skill, but use it to avoid or counteract security procedures used to spy on them or capture them. While dissident characters could take the Law Enforcement specialization (learning policing techniques in order to avoid them), they can also take their own specialization, Dissident Operations.

Dissident Operations can be thought of as “counter-Security”: while it doesn’t provide the ability to



disarm actual alarms and security devices (that requires the Security Systems specialization), it does teach the character how to avoid a tail, detect and disarm listening devices, hold a meeting with a fellow dissident without being seen or overheard, and similar tricks of the dissident’s trade.

SHIPBOARD SYSTEMS

Most shipboard systems aren’t all that different between Federation and Romulan technology; the equipment looks different but functions more or less the same. Romulans often learn an additional specialization, however, that their Starfleet counterparts do not.

CLOAKING DEVICE (NEW SPECIALIZATION)

This specialization covers the operation of the cloaking device. A skilled cloaking device operator can eliminate some of the risk inherent in decloaking and activating shields. Normally there’s a multisecond period between the instant a Romulan ship decloaks and when it turns on its shields. A deft hand at the cloaking device controls can reduce this time period, and thus the chance that an enemy can fire on the Romulan ship while it has no shields. Per the rules on page 144 of the *Star Trek: The Next Generation Role-playing Game* core rulebook, it requires a Challenging (11) Shipboard Systems (Sensors) Test for an enemy to detect the “window of vulnerability,” at which point it can attack the Romulan ship at +3 Difficulty—and, if it hits, do full damage, since the Romulan shields will not yet have been activated. If the cloaking device operator makes a Challenging (10) Shipboard Systems (Cloaking Device) Test as he decloaks his ship, the Shipboard Systems (Sensors) Test becomes Nearly Impossible (13), and if successful the enemy must target the Romulan ship at a +4 Difficulty.

UNARMED COMBAT

Given their long, proud military tradition, it’s not surprising that the Romulans have developed a wide variety of martial arts styles and techniques. The

seemingly constant political infighting, which occasionally flares into violent encounters in the shadows between "soldiers" hired by rival factions, has only created yet another forum in which Romulans can exercise their unarmed fighting skills. Some of the more important or interesting Romulan martial arts are detailed below.

Romulans tend to be very secretive about their fighting styles. Few, if any, non-Romulans have ever learned them. In fact, some of the styles and maneuvers described below aren't even known to exist by the Federation and other enemy races. Any time the Romulans have had to use them in combat, they make sure that all witnesses do not leave the battle alive.

ROMULAN NAVY MARTIAL ARTS (NEW SPECIALIZATION)

This style could be considered the equivalent of the Starfleet Martial Arts techniques taught at Starfleet Academy. Every Romulan who goes through the *Serona* learns a few basic maneuvers from this style; Romulans who attend the Romulan War College learn the entire package of maneuvers.

Naval Martial Arts represent a basic conglomeration of other styles. The result is a fairly simple and straightforward meta-style which avoids fancy or flowery maneuvers, and instead concentrates on direct attacks and defenses. The purpose of the style is to knock an opponent out or kill him as quickly as possible, not to defeat him using esoteric techniques.

Romulan Navy Martial Arts maneuvers are listed on the table on page 29. Those marked with an asterisk (*) represent those which cadets learn during *Serona* training.

TENALRI (NEW SPECIALIZATION)

If Humans knew about this martial art, they'd probably call it "Romulan kickboxing." *Tenalri* was developed several hundred years ago by street

toughs who haunted the alleys of some of the larger Romulan cities, fighting with each other and committing petty crimes. Eventually they concentrated solely on fighting among themselves; skill in combat was seen as a sign of superiority and power, and brought profit and prestige.

Eventually the art became legitimate and gradually moved from the streets and into the mainstream. Today, it is best known to most Romulan citizens as a sport on which they bet. Broadcast *Tenalri* matches are one of the most popular forms of entertainment on modern Romulus, and rivalries among fans of the most popular fighters can become intense. In addition to the style's maneuvers, practitioners of *Tenalri* should also know the Dodge skill at level 2 or higher.

KORMEREK (NEW SPECIALIZATION)

The precise origins of this martial arts style are lost in the mists of time, but none can deny its roots are quite ancient. Some scholars believe it derives from fighting techniques learned by the proto-Romulans before they fled Vulcan, perhaps from one of the ancient religious orders. Others claim it was developed by Romulans to help them fight the Zelvorians. The truth will probably never be known.

Kormerek is a swift, brutal fighting style. It concentrates on nerve strikes, bone- and joint-breaking, and similar techniques. When two *Kormerek* practitioners meet on the field, one of them, at least, is going to leave it bloody (if he leaves at all)—and it's not uncommon for both fighters to be covered in their own blood by the end of a match. Although blocking attacks are allowed under the conventions governing the style, *Kormerek* practitioners consider dodging to be cowardly and do not engage in such practices.

Kormerek practitioners are sometimes looked at askance by "respectable" Romulans. The style is known for its viciousness, and many believe that anyone who practices it is a violent, ruthless thug and leg-breaker.



UNARMED COMBAT

NAVAL MARTIAL ARTS

| Action | Difficulty | Damage | Notes |
|--------|------------|--------|---|
| Block* | — | — | Parries unarmed hand-to-hand attack. The character rolls an Unarmed Combat Test to establish a Difficulty for hitting him with such attacks. |
| Disarm | 9 | — | Attacker and target make Opposed Fitness Tests (modified by Strength); the attacker receives a +2 bonus to his roll. If the attacker succeeds, the target drops his weapon or other item he is holding. |
| Grab | 8 | — | This maneuver is identical to the basic Grab maneuver described on page 126 of the core rulebook, but is slightly easier to execute. |
| Kick* | 84 | +1d6 | |
| Punch* | 73 | +1d6 | |
| Throw | 81 | +1d6 | Target is thrown to the ground and suffers penalties for being prone until he gets to his feet (which takes an action). |

TENALRI

| Action | Difficulty | Damage | Notes |
|-----------------|------------|--------|--|
| Block | — | — | Parries unarmed hand-to-hand attack. The character rolls an Unarmed Combat Test to establish a Difficulty for hitting him with such attacks. |
| Hand Strike | 7 | 3+1d6 | |
| Leg Sweep | 7 | 2+1d6 | In addition to taking damage, the victim is thrown to the ground and suffers penalties for being prone until he gets to his feet (which takes an action). |
| Pivoting Kick | 6 | 4+1d6 | A character who uses a Pivoting Kick suffers a -1 to the Difficulty to hit him with any hand-to-hand combat maneuver or weapon in the round in which he uses the kick. |
| Roundhouse Kick | 8 | 5+1d6 | |
| Snap Kick | 7 | 4+1d | |

KORMEREK

| Action | Difficulty | Damage | Notes |
|----------------|------------|---------|--|
| Block | — | — | Parries unarmed hand-to-hand attack. The character rolls an Unarmed Combat Test to establish a Difficulty for hitting him with such attacks. |
| <i>Durasha</i> | 7 | 4+1d6 | A fist-smash or punch. |
| <i>Kuluri</i> | 9 | 2+2d6 | This maneuver is a strike, usually using the hand or fist, against nerve clusters and other vulnerable points on the body. Stun Damage only; Strength does not add to the damage; see rules for Stun Damage on page 133 of the core rulebook. Increase the Difficulty of the Test by 1 if the target is a humanoid but a non-Romulan, and by 3 if the target is a non-humanoid. |
| <i>M'larek</i> | 11 | 5+2d6 | This is the infamous "bone-breaking strike" of the <i>Kormerek</i> masters. Usually performed with a fist or the edge of an open hand, it allows the practitioner to break bones and inflict grievous internal injuries. In many cases the only visible sign that an injury has been suffered (other than the look of agony on the victim's face) is a bruise or small cut. |
| <i>SidroK</i> | 9 | Special | This maneuver allows the attacker to grab one of the target's arms or other limbs and break it, typically at a joint such as the elbow or wrist. If the attack is successful, the attacker must make an Opposed Test against his target using Fitness (modified by Strength and the practitioner's significant advantage) to break the limb. This causes the target to become incapacitated and the limb to be useless until healed. |

UNARMED COMBAT

 **N'DELREK**

| Action | Difficulty | Damage | Notes |
|----------------|------------|--------|--|
| <i>Golradi</i> | 7 | — | This maneuver is a joint lock. If successful, the character has grabbed one of his opponent's limbs (usually an arm) and effectively immobilized it, preventing the attacker from using that limb until he frees it. The characters must make an Opposed Test using Fitness (modified by Strength) each round to determine whether the grabbed character can free his limb. This Opposed Test is an Immediate Action, but may only be attempted once per round. The attacker is free to use his other limbs to attack, but all such attacks are at -2 due to awkwardness. A Romulan may, if he wishes, use both of his arms to immobilize opponents, but this will of course restrict his own ability to make other attacks. |
| Grab | 7 | — | This maneuver is identical to the basic Grab maneuver described on page 126 of the core rulebook, but is easier to execute. |
| <i>Huunar</i> | 3 | 1+1d6 | This maneuver may only be used after the character has successfully used a Grab or <i>Golradi</i> on his target. It consists of throwing or slamming the target to the ground hard enough to hurt him. Typically the attacker goes to the ground as well (without suffering any damage), but if his Unarmed Combat Test Result is 5 or greater, he may remain standing if he so chooses. In either case the attacker maintains his hold on his target. |
| <i>Kellad</i> | 7 | 3+2d6 | This maneuver is a nerve strike; it may only be used on a target who has been grabbed or overborn. It causes Stun Damage only; Strength does not add to the damage; see rules for Stun Damage on page 133 of the core rulebook. Increase the Difficulty of the Test by 1 if the target is a humanoid but a non-Romulan, and by 3 if the target is a non-humanoid. |
| Strike | 9 | 1+2d6 | A basic punch, kick, or other strike. |

 **CH'VASHREK**

| Action | Difficulty | Damage | Notes |
|--------------|------------|---------|--|
| Blind | 11 | Special | The practitioner strikes the target in its eyes (or other sensory organs)—not hard enough to injure them, only hard enough to cause temporary blindness. The victim cannot see for 1d6 rounds; he is at -4 on all rolls to hit targets in melee combat and -8 for all rolls to hit targets in ranged combat unless he has some other means of sensing them accurately. |
| Block | — | — | Parries unarmed hand-to-hand attack. The character rolls an Unarmed Combat Test to establish a Difficulty for hitting him with such attacks. |
| Disarm | 9 | — | Attacker and target make Opposed Fitness Tests (modified by Strength); the attacker receives a +2 bonus to his roll. If the attacker succeeds, the target drops his weapon or other item he is holding. |
| Grab | 8 | — | This maneuver is identical to the basic Grab maneuver described on page 126 of the core rulebook, but is slightly easier to execute. |
| Kick | 8 | 4+1d6 | |
| Nerve Strike | 9 | 2+2d6 | This maneuver causes Stun Damage only; Strength does not add to the damage; see rules for Stun Damage on page 133 of the core rulebook. Increase the Difficulty of the Test by 2 if the target is a humanoid but a non-Romulan, and by 4 if the target is a nonhumanoid. |
| Power Kick | 9 | 5+1d6 | |
| Punch | 7 | 3+1d6 | |
| Rapid Punch | 6 | 2+1d6 | |
| Throw | 8 | 1+1d6 | Target is thrown to the ground and suffers penalties for being prone until he gets to his feet (which takes an action). |



N'DELREK (NEW SPECIALIZATION)

N'delrek, thought to be nearly as old as *Kormerek*, is also considered much more “respectable” than the bone-breaking art. Comparable in some ways to Earth styles such as jujitsu and wrestling, *N'delrek's* techniques concentrate on obtaining a hold on the target and then immobilizing him or forcing him to the ground. Once a target is vulnerable, he can be rendered unconscious—or even dead—with attacks and nerve strikes.

CH'VASHREK (NEW SPECIALIZATION)

Although not as old as *Kormerek* or *N'delrek*, *Ch'Vashrek* has still been around for a long time—well over a thousand years. Modern-day masters trace its origins to an ancient temple of warrior-priests, the *Ch'Vash*. The leaders of the temple developed a series of exercises to keep the monks in fighting trim. Gradually, over the course of a century or so, these exercises merged with certain weapon techniques to create an unarmed fighting style. The monks of *Ch'Vash* became feared throughout the land for their prowess, and kings and generals sought their service as mercenaries.

Over time, the monks taught outsiders their techniques, and the number of instructors claiming to teach “true” *Ch'Vashrek* proliferated. With this proliferation, the style began to diverge, as these outsiders developed their own techniques. Eventually there were many different fighting styles all lumped together under the name of *Ch'Vashrek*. Some were hard, fast, direct styles; others were sinuous and graceful and emphasized reacting to attack rather than initiating it. Many other variations developed. Today there are hundreds of different *Ch'Vashrek* “schools” on Romulus, each teaching its own blend of the various techniques.

Since it is rare (some would say impossible) for any one Romulan to learn every *Ch'Vashrek* maneuver, characters should choose up to five maneuvers from the list below to represent the ones known to them. They may learn an additional five maneuvers for an additional *Ch'Vashrek* specialization.

SCIENCE SKILLS

By and large, Romulan scientific skills and accomplishments are roughly the same as those of the Federation. While Romulan scientists are more frequently ordered to direct their research toward military ends—building bigger, faster, better-armed starships, for example—they go about their research in the same way Federation scientists do. They also have more or less the same specializations, though again often with an eye toward the military's needs.

SOCIAL SCIENCES

Of particular note here is the specialization Archaeology. Study of the ancient past and its relics has always been popular among Romulans, even those who merely have a “dilettante's interest.” Furthermore, archaeology is thought to serve the interests of the state as well. Romulan leaders are well aware that there are many long-dead galactic civilizations who have left behind technology of amazing power—power that the Romulans would like to harness.

Romulan archaeological teams can be found investigating sites such as the dwelling places of the proto-Romulans during their diaspora after leaving Vulcan, the ruins left behind by the Debrune, and possible Iconian sites (where the Romulan high commanders are particularly hopeful of finding an ancient superweapon they can use to further the cause of *D'era*).

OTHER SKILLS

ARTISTIC EXPRESSION

Despite their reputation as warlike drones, Romulans are in fact very interested in all forms of art and hold their artists in high regard. Both private patrons and (for the more traditional artists) government funds ensure that Romulan cities are always gloriously decorated. Some of the more popular art forms include cooking and brewing (especially of the potent Romulan ale), playing the *sirune* (a harplike instrument with twenty strings) or the *levroc* (a pianolike instrument with fourteen keys and six pedals), painting (especially of “firescapes”, portraits of the Firefalls of Gal'Gathong and similar natural features), and *tillion* (a type of sculpture governed by strict rules regarding the tools, materials, and methods which can be used).

INTIMIDATION

This skill is a specialty of the *Tal Shiar*; all Romulans, even those in positions of power, fear the possibility of falling into *Tal Shiar* hands for this very reason. Plenty of other Romulans, however, are good at Blustering, particularly military officers.

CROSS EXAMINATION (NEW SPECIALIZATION)

A more subtle, though by no means less effective, means of extracting information from an unwilling suspect. Cross Examination relies on the use of pointed questions to obtain answers, moving on to an unrelated subject, then surprising the suspect with the original subject in the hopes of tripping him up;

NEW SKILLS

Meditation
 Politics
 Surveillance

NEW ADVANTAGES

Benefactor
 Cohorts
 Hereditary Benefit
 Tolerance

NEW DISADVANTAGES

Dark Secret Revealed
 Imprudent
 Outcast
 Power Hungry
 Shamed
 Watched

knowing when to badger a suspect and when to lay off; and turning the suspect's own words against him. Those subjected to an expert cross examination comment that they feel as though they were tortured. It is commonly used by intercessors and *Tal Shiar* agents.

PRIMITIVE WEAPONRY

As with Unarmed Combat, the Romulans have a long history of creating and using melee weapons and other "primitive" weapons. Although they don't have as many, and don't use them as often, as the Klingons, their proud warrior tradition will not let them simply discard their primitive weapons as useless in the age of disruptors.

Most Romulans who learn to use these weapons do so either from private tutors or at the Romulan Collegium of Ancient Warfare. The latter institution is an adjunct to the Romulan War College; the government maintains it primarily out of a sense of martial pride. Anyone who has completed his *Serona* or is in the military is eligible to undertake a course of study there.

For a list of primitive Romulan weapons, and thus the specializations available, see "Chapter Five: The Tools of Conquest," in *The Romulans*.

PSIONIC SKILLS

Psionic skills are very, very rare among Romulans. Approximately .00001% of the population possess any sort of psychic ability, and usually the talents are so weak that they are effectively useless. Very few reach level 1 with any Psionic skill, much less level 2 or higher.

Of those Romulans who do possess useful Psionic skills, Mind Shield is by far the most common. Other than that, the Psionic skills are distributed roughly equally throughout the psionic population. Mind Control is generally regarded as the most desirable ability, but any of them are useful and worth having. The government and various government officials usually try to snap up young psychics and train them to be bodyguards, advisors, spies, and the like. There is no central training authority or academy for psychics, since anyone who has control of a young psychic prefers to keep that secret. Other psychics are brought in as tutors instead.

It is well known on Romulus that Romulans have great psychic potential. Like their Vulcan forebears, the possibility of great psionic powers is locked within their brains. Unlike the Vulcans, the Romulans have done little to develop that potential, and so remain without a large number of psionics. The government conducts extensive research into the problem, hoping to find a way to "jumpstart" psionic powers in Romulans and create a vast corps of "psychic warriors." Meanwhile, the *Tal Shiar* maintains a program for the few Romulan psychics they find.

New Skills**◀ MEDIATION (PRESENCE)**

Mediation measures a character's ability to assist disputants in resolving their differences. He can listen to each side's argument, analyze and objectively describe the weak points in each position, and in so doing help the quarreling parties reach a compromise. Judges, intercessors, negotiators, lawyers, and mothers with multiple children often possess this skill.

Mediation is related to skills such as Diplomacy, Persuasion, Charm, and Law, but is subtly different. It does not involve arguing or negotiating one's own position; rather, it allows the character to help two (or more) other people to analyze their own arguments so that disputes can be ended in a manner beneficial for everyone concerned. While a mediator, in a sense, persuades other people, he really just provides a neutral, third-party view of their arguments to help them see the weaknesses in them, so they can realistically and rationally evaluate how good their position really is.

Routine: Mediating a property division during a friendly divorce; helping two allied powers to divide a territory

Moderate: Mediating a property division during a contested divorce; helping two neutral powers to divide a territory

Challenging: Mediating child custody during a contested divorce; helping two antagonistic powers to divide a territory

Difficult: Mediating a property division or child custody during a bitter, spiteful divorce; helping two ancient enemies divide a territory

Nearly Impossible: Mediating a territory division between Bajorans and Cardassians

Specializations: Civil, Commercial, Political

▷ POLITICS (INTELLECT)

While the Political Science specialization of the Social Sciences skill covers the study of political systems and processes, the Politics skill represents the actual practice of politics. Politics combines elements of Charm and Social Sciences (Politics) with information-gathering techniques. A character would use this skill to manipulate the political system and navigate the political arena. Characters with this skill can use it to learn about a backroom deal, for political “horse-trading”, to plot political strategy or anticipate someone else’s political strategy, to influence senators, and to forecast the likely effects of a political decision. This skill also encompasses political psychology, the practice of manipulating large groups of people.

When used against another politician—to discover Senator Kassus’ next move, to plot to embarrass Senator Miret, to oppose Senator Pardek’s legislation—make an Opposed Test using his Politics skill. If the acting character’s maneuver was intended to be secret, then a failed Skill Test may indicate that it can be traced back to the source.

The Maneuver specialization determines how well the character can turn political events in his favor, such as using a vote to embarrass a political foe, smearing another’s reputation, or swaying large groups of people. The Intelligence specialization focuses on the character’s ability to gather information in the political arena, such as discovering the real sponsor of legislation or detecting a shift in coalitions in advance.

Routine: Influencing a sympathetic senator; swaying a receptive audience; gauging the political winds (e.g., who’s up and who’s down)

Moderate: Influencing an opposing senator; swaying an undecided audience; uncovering a senator’s agenda

Challenging: Recovering from a minor scandal (e.g., accused of using your office for personal gain); swaying a hostile audience; uncovering a “backroom” deal

Difficult: Recovering from a major scandal (e.g., accused of treason); uncovering a secret “backroom” deal

Nearly Impossible: There is no Nearly Impossible task in politics

Specializations: Intelligence, Maneuver, Propaganda



▷ SURVEILLANCE (INTELLECT)

This optional skill allows a character to observe a person, place, or object, either with his own senses or electronically, to gather intelligence about the subject or find out what he/it is doing. Depending upon the specialization chosen, the character may be skilled at planting electronic listening and recording devices (“bugs”), using special surveillance sensors and related equipment, or following a subject without being detected.

Routine: Planting a bug in a typical room; following someone in a crowd

Moderate: Using electronic surveillance equipment through low-level interference

Challenging: Planting a bug on a starship; following someone in a lightly occupied area

Difficult: Planting a bug in Starfleet Headquarters

Nearly Impossible: Following someone in a desert

Specializations: Bugging, Electronic Surveillance, Shadowing, Standard Surveillance

Advantages

EXISTING ADVANTAGES

The following advantages are good for representing various aspects of the Romulan personality or culture. Remember that Romulan characters may view or use advantages differently than their Starfleet counterparts.

ALIEN UPBRINGING (+1)

This advantage is fairly rare for Romulan characters because of the general insularity of Romulan society. On the other hand, a player could easily design a character who, for example, as a baby was the only survivor of the wreck of a Romulan starship. The planet's natives raised the child as one of their own. This might be one way to allow a player to have a Romulan character who is a member of Starfleet.

COMMENDATION (+1 TO +3)

The Romulan Empire hands out awards and honors to those who distinguish themselves in service to the Empire. This always involves an award of Renown points, included on the Commendation table. The player and Narrator should determine the reason for the commendation and assign the points to the appropriate aspect (Aggression for valor in battle, Discipline for loyalty to the Empire, etc.). Some of the most prominent awards and honors which the Romulan Star Empire can bestow include.

| COST | RENOWN | COMMENDATION |
|------|--------|---|
| 1 | 2 | Commendation (Imperial Falcon, Ribbon of Distinction) |
| 2 | 4 | Minor Award (service award, Imperial Star, Award of <i>Belek N'Rel</i>) |
| 3 | 6 | Major Award (Imperial Medal of Honor, Praetorian Ribbon, Senatorial Award of Merit) |
| 4 | 8 | The Order of the <i>Ra'tar</i> |

CONTACT (+1 TO +4)

The character knows someone somewhere who could come in handy some day. The contact will perform a small favor for the character, such as providing information, running an errand, or supplying material assistance. A contact in the Romulan military might know why warbirds have been dispatched to the Jubel Sector, while a contact in the *Tal Shiar* might alert you to an investigation into your past. The amount of points spent on this advantage determines the contact's position and usefulness. Unlike Cohort and Benefactor, this advantage does not provide Renown.

| COST | CONTACT |
|------|--|
| 1 | Low-level figure (e.g., sublieutenant or lieu tenant, clerk, street thug) |
| 2 | Mid-level figure (e.g., subcommander or commander, senatorial aide, street boss) |
| 3 | High-level figure (e.g., centurion, senator, ringleader) |
| +1 | For contact in the <i>Tal Shiar</i> |

DEPARTMENT HEAD (+1 TO +4)

The cost of this advantage depends on the class of ship on which the character serves. The Renown listed on the table refers to the total Renown in Aggression, Discipline, and Skill, and merely represents a suggestion for Narrators.

| COST | RENOWN | CLASS OF SHIP |
|------|--------|--|
| 1 | 10 | <i>T'rasus</i> -class ship |
| 2 | 15 | <i>Meret</i> -class ship |
| 3 | 20 | <i>D'valek</i> -class ship |
| 4 | 25 | <i>D'deridex</i> -class or <i>Vereleus</i> -class ship |
| +1 | +5 | First Officer |

These totals apply to the standard departments on a Romulan ship, such as Chief Medical Officer and Chief Engineer. To be the First Officer, add 5 to the Suggested Renown for the ship involved (e.g., 15 for a *T'rasus*-class ship).

FAMOUS INCIDENT (VARIES)

You participated in an event of far-reaching importance, bringing glory to the Praetor and the Empire. The player and Narrator should work together to determine the nature of the incident. The character receives 2 Renown Points for every Development Point spent on this advantage (either in Aggression [for battle], Discipline [for serving the Empire], or Skill).

The more Development Points spent on this advantage, the more famous the incident. Players should work to make such incidents both interesting and relevant to their character's background. This advantage may explain how a Romulan character joined Starfleet, if that's what a player wants. For example, perhaps the character is renowned as a defector from the Empire who saved thousands of Federation lives through a timely and noble sacrifice.

MIXED SPECIES HERITAGE (+6)

Romulans can cross-breed with humans, Klingons, and Vulcans (other crossbreeds may be possible, but they currently remain undocumented). Usually such "halfbreeds" are sterile, but in some cases, particularly in the case of Vulcan/Romulans, may be capable of breeding with either species. Players are free to construct their own Mixed Species Templates according to the rules in the core rulebook (page 103), but some suggested Templates are included in the box on the following page.

These Templates include only Attributes, and assume the Romulan side of a character's heritage remains dominant; the player chooses the skills from the Template which reflects the society he was raised in (normally this will be Romulan society—typically a character with Mixed Species Heritage is raised by his "dominant" species—but in some rare instances the situation might be otherwise).

HUMAN/ROMULAN TEMPLATE

Coordination 2 [5]
Fitness 2 [6]
Strength +1
Intellect 2 [5]
Perception +1
Presence 2 [5]
Willpower +1
Psi 0 [5]

KLINGON/ROMULAN TEMPLATE

Coordination 3 [5]
Fitness 3 [6]
Vitality +2
Intellect 2 [5]
Perception +1
Presence 2 [5]
Empathy -1
Psi 0 [6]

VULCAN/ROMULAN TEMPLATE

Coordination 2 [5]
Fitness 2 [6]
Strength +1
Intellect 2 [6]
Logic +1
Presence 2 [5]
Empathy -1
Psi 1 [6]
Range -1

NEW ADVANTAGES

The following section provides some new advantages that Romulan characters can purchase. Players should consult the Narrator before purchasing them.

BENEFACTOR (+2 TO +5)

Someone important or influential has taken an interest in your life and wants to see you succeed. From time to time, you may call on this person to provide advice, help you out of trouble, or manipulate events in your favor, but don't expect this for free—there may come a time when your benefactor needs something from you.

By virtue of your benefactor's position, you receive a Renown award for being known as his protégé. The cost of this advantage determines how influential the benefactor is, and how much Renown he provides. The player and Narrator should work together to create the Benefactor character.

| COST | RENOWN | BENEFACTOR |
|------|--------|--|
| 2 | 4 | Moderate figure (e.g., a commander, a <i>Tal Shiar</i> major) |
| 3 | 6 | Influential figure (e.g., a centurion, <i>Tal Shiar</i> colonel, or senatorial aide) |
| 4 | 8 | Important figure (e.g., a senator, an admiral) |

+1 for *Tal Shiar* Benefactor*
+1 per 2 additional points of Renown

Note

*Because of the far-ranging reach of the *Tal Shiar*, a benefactor in the Romulan secret police costs one additional point.

COHORT (+2 TO +6)

The character has a close relationship—either a friend or a relative—with someone in a position of power and influence. Your cohort will go out of his way for you, more so than a benefactor (who might throw you overboard for political reasons). You may call on this person to provide information, help you out of trouble, or manipulate events in your favor.

In return, your cohort might require your assistance from time to time; repeatedly turning down a cohort may lead to an end to the relationship. Consult the table below for the cost of this advantage, the cohort's position, and the amount of Renown awarded. (The player, with advice from the Narrator, should decide how this relationship affects his Renown, and apply the Renown listed on the table to the appropriate aspect).

| COST | RENOWN | COHORT* |
|------|--------|--|
| 2 | 4 | Moderate figure (e.g., a commander, a <i>Tal Shiar</i> major) |
| 3 | 6 | Influential figure (e.g., a centurion, <i>Tal Shiar</i> colonel, or senatorial aide) |
| 5 | 10 | Important figure (e.g., a senator, an admiral) |

+1 for *Tal Shiar* Cohort*
+1 per 2 additional points of Renown

Note

*Having a cohort within the *Tal Shiar* can be a powerful advantage, and thus costs one additional point.

HEREDITARY BENEFIT (VARIES)

Romulans with this advantage gain a tangible benefit as a result of their lineage, such as a parcel of land to call their own, a fabled family heirloom, or a

USING ALLIES AND BENEFACTORS

In the *Star Trek: The Next Generation RPG*, the frequency with which allies and patrons appear in a game, and their effect, is left largely to the Narrator's discretion (see page 104 of the *ST:TNG RPG* core rulebook).

In Romulan society, calling upon one's powerful friends has a cost. The more a character calls on outside help to solve his problems, the less effective he appears, and the less willing to answer his requests his connections become. Senator Pardek may be willing to help a friend, especially if that friend is well regarded, but can only do so many favors before he loses his patience, for example.

To bring one of these nonplayer characters into an episode requires the expenditure of Glory Points. As your Glory increases, so does your influence in the Empire; people tend to like a winner. Once you spend all your Glory, however, you've traded in all your favors and exhausted all your connections, and must wait until you earn more Glory.

small merchant freighter. Although you begin the game with this benefit, you can lose it through the course of game play (family lands confiscated by the *Tal Shiar*, for example). An antique *lirash*, annual profits from a small farm, or a personally owned Romulan shuttle are only some examples.

Because of the wide range of possibilities, there can be no set guidelines for the cost in Development Points. Generally, the more useful or powerful the Hereditary Benefit, the more points it should cost.

TOLERANCE (+2 TO +4)

The character has built up a tolerance to a particular substance. While this could be fairly innocuous (a Tolerance for Romulan ale, allowing the character to drink others under the table without any trouble), it is mainly purchased by characters who fear assassination by poison (an ancient, and still respected, art in the Romulan Star Empire). By taking small doses of a poison, a character can build up an immunity to its effects.

A character with Tolerance gets a base +2 on all Tests made to resist the effects of, or damage from, poisons and similar substances. For purposes of determining the character's Resistance to poisons, and his Wound Level from such attacks, his Fitness is considered doubled, and any Glory Points spent to resist the damage further have double effect (i.e., they add +2 Resistance per Glory Point spent).

TOLERANCE COST

| Cost | Substance |
|------|--|
| 2 | Uncommon and/or mildly dangerous substances (rare alcohols or poisons) |
| 3 | Common and/or dangerous substances (Romulan ale, most serpent venoms) |
| 4 | Very common and/or very dangerous substances (poisons such as curare) |

ESPIONAGE ADVANTAGES

The Starfleet Intelligence Handbook contains several new Advantages for spies, such as Deep Cover and Security Clearance. Both are reprinted here, though modified for Romulan characters. The *Tal Shiar* Overlay presented earlier in this chapter provides a 3-point Security Clearance; with the Narrator's permission, players may alter this as they see fit.

DEEP COVER (+2)

The character has an extremely well developed alternate identity. Great care has been taken to ensure the cover identity's records, permits, and background history are impeccable. If the character does anything to "blow" his cover—like exhibiting an emotional tirade as a Vulcan—the damage could be irreparable; the character loses his alternate identity (and the points spent on this Advantage). The player must define his character's Deep Cover at the time of character creation.

SECURITY CLEARANCE (+1, +3, +5)

The character possesses a security clearance and can access restricted information. Security clearance depends less on rank and more on the character's "need to know." Thus, Senator Pardek may have access to secret material, while Senator Kassus has access to ultrasecret data. A character may take this Advantage to represent a greater security clearance than his rank would typically warrant. The cost depends upon the level of clearance desired.

COST CLEARANCE LEVEL

| | |
|---|--|
| 1 | <i>Ruta</i> (secret) material |
| 3 | <i>Vay'Ruta</i> (top secret) material |
| 5 | <i>Gal'Ruta</i> (ultrasecret) material |

Disadvantages

EXISTING DISADVANTAGES

The following disadvantages are, generally, good for simulating some of the more common aspects of the Romulan personality or society: Argumentative, Arrogant, Code of Honor, Obligation, Rival, Sworn Enemy, Vengeful.

CODE OF HONOR (-2 TO -5)

The Romulans, as is well known, are an honorable people. While it's true some individual Romulans (including just about any *Tal Shiar* agent) aren't very honorable, the average Romulan places great importance on his honor. The following box lists some of the most common Romulan Codes of Honor.

A Romulan character may take two of these codes if the player so desires. In fact, a lot of interesting roleplaying can result from bringing the two codes

into conflict—for example, a situation in which the character must act ignobly or go back on his word in order to support the Empire.

VALUE DESCRIPTION

- 2 *Personal Honor:* Always act with honor and nobility; always keep your word (note that this does not prevent a Romulan from lying).
- 3 *Code of D'era:* Always support the Empire, the Praetor, and their goals, including D'era; always do your duty; weakness is intolerable.
- 3 *Code of Fidelity:* Do what is good for the Romulan people, as opposed to the Romulan Empire, regardless of the cost. Example: Going to war with the Federation may be good for the Empire, but will it benefit the Romulan people?
- 3 *Code of Ket-cheleb:* The strong survive and the weak perish; this is the way of the universe. Prove yourself worthy of life by continually testing yourself in conflict (verbally, strategically, or spiritually) against non-Romulans.
- 5 *The Centurion's Oath:* Respect and obey those above you, even if you disagree with their orders.

IMPULSIVE (-1)

Romulans rarely take this disadvantage. They are taught from an early age to wait, observe, and then act after their opponent has made the first move; patience is seen as an essential virtue. Thus, impulsiveness is frowned upon, and most Romulans learn not to act without thinking.

OBLIGATION (-1 TO -3)

This disadvantage is the flip side of advantages like Cohort or Benefactor. While many Romulans have a network of contacts and people who owe them favors, at the same time they themselves are part of other peoples' networks.

At the Narrator's option, the character may owe his Obligation not to a specific individual but to a discrete group—for example, the *Nej'ahar* Party. Since this may expand the scope of the disadvantage, the Narrator may wish to increase the value of the disadvantage by -1 or more.

VALUE OBLIGATION

- 1 Family or small circle of associates
- 2 A small community (e.g., home town, organization, political staff)
- 3 A large community (e.g., a country or province, a fleet, a governmental agency)
- 4 Widespread (e.g., all fellow citizens, all military superiors or personnel, all Imperial clients)



NEW DISADVANTAGES

Here are several new disadvantage for Romulan characters. At the Narrator's option, some other characters may be allowed to take these as well.

DARK SECRET REVEALED (-2 TO -4)

The character not only has a dark secret, but someone knows it and uses it against the character. This could range from a superior officer who knows you cheated at the War College and holds you back for promotion, to the *Tal Shiar* using your brother in the Romulan underground to coerce you. Typical examples of dark secrets include membership in the Romulan underground, your plot against a rival senator, or your sympathetic feelings for the Federation.

The player and Narrator should work out the nature of the secret; in general, only a small number of people should know your dark secret. If the character's dark secret becomes widely known, he may earn a large amount of negative Renown. Players are not required to purchase this disadvantage separately.

VALUE SECRET

- 2 Embarrassing ("You're only half-Romulan!")
- 3 Career-ruining ("Your brother belongs to the underground!")
- 4 Life-threatening ("You belong to the underground!")

IMPRUDENT (-1)

The darker side of Resolute, Imprudent differs from Impulsive. An Impulsive character takes rash action; an Imprudent character doesn't know when



to give up. You've never heard the saying "He who fights and runs away lives to fight another day." You stay at your post, firing the ship's disruptors, even though the ship is lost; continue to argue your point, even though the debate is settled; and persist in your attempts to travel to Iconia, even though the Federation stands in your way. If you spend 1 Glory (or Courage) Point, you abandon your reckless behavior. Attempts to dissuade an Imprudent character from foolishly pursuing his goal are made at a -1 die penalty.

OUTCAST (-1 TO -4)

This Disadvantage is appropriate solely for non-Romulans within the Empire, and is included here for Narrators who wish to include them as supporting cast characters. The alien has attained citizenship in the Romulan Empire, typically through *Serona* service, and has been ostracized by his people as a collaborator. In cases where the character must interact with members of his species, he rolls an additional die when making a Renown Test. Recognition is more likely to be negative, even if the character's aspects would normally indicate a positive response.

The value of this disadvantage depends upon the number of people who shun the character.

POWER-HUNGRY (-1 TO -2)

The character is obsessed with accumulating power, be it in the military, *Tal Shiar*, or political arena. This power need not be official, as a position of influence. It could be power from the shadows, power derived from being owed favors, or criminal power. Whenever the character has an opportunity to enhance his own personal power, he must spend 1 Glory Point to resist pursuing his own political agenda. Examples include making a side deal with someone, perhaps counter to the mission objectives; blackmailing a dissident, trading freedom for a favor; and double-crossing your friends for political gain.

For an additional 1 Development Point, the character loses one die when attempting any Command, Diplomacy, Persuasion, or Charm Skill Tests, unless he spends 1 Glory Point. The character cannot resist lording his clout over others, ranging from name-dropping to outright insolence.

SHAMED (VARIES)

The character has committed some act that caused him to lose prestige—surrendered to a Starfleet captain, abandoned his post, or failed spectacularly in front of a large group. This stigma continues to haunt the character, no matter what he does to regain his honor. For every 2 negative Renown Points, the character receives 1 Development Point. The bigger the disgrace, the more Renown lost; the character can earn a "negative" total Renown in this fashion (e.g., going from Aggression 0 to Aggression -2).

The player should determine the nature of his character's shame, and reduce the appropriate Renown aspect. If a supporting cast character succeeds in a Renown Test against the character, he invariably recognizes the character for his shameful behavior.

WATCHED (-2)

The character is being watched or is under surveillance by someone who is suspicious of, or hostile toward, him. In Romulan society this usually means either the *Tal Shiar* or *Tal Diann*, but it could also be a rival, an enemy political faction, or someone similar. The watcher will use any means at his disposal, from physical surveillance to electronic "bugging" to tracking the character's use of computer systems, to watch the character.

A watcher's purpose is mainly to keep tabs on the character and compile a dossier of information on him. There may be a sinister purpose behind this activity—collecting blackmail information about the character, for example—or it may be that the watcher wants to maintain a complete file on the character "just in case." In any case, it's bad news for the character, who will have difficulty conducting private meetings and keeping things to himself.

SCIONS OF THE EMPIRE

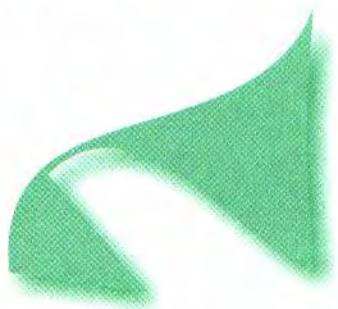

Praetor Neral

ATTRIBUTES

Fitness 2
Strength +1
Coordination 3
Intellect 3
Perception +1
Presence 4
Empathy -1
Psi 0

SKILLS

Administration (Romulan Government) 4 (5)
Charm (Influence) 3 (5)
Computer (Hacking) 3 (4)
Culture (Romulan) 2 (4)
Diplomacy (Interstellar Law) 3 (4)
Dodge 2
Energy Weapon (Disruptor) 1 (3)



Espionage (Observation) 2 (4)
 History (Romulan) 1 (3)
 Intimidation (Influence) 4 (5)
 Language
 Romulan 3
 Law (Romulan) 2 (4)
 (Romulan Military Regulations) (3)
 Persuasion (Oratory) 4 (5)
 Politics (Intelligence) 4 (5)
 (Manipulation) (6)
 Primitive Weaponry (*Lirash*) 1 (2)
 Social Science (Political Science) 1 (3)
 Stealth (Stealthy Movement) 1 (2)
 Strategic Operations (Romulan Strategies) 2 (4)
 Unarmed Combat (Romulan Navy Martial Arts) 1 (2)
 Vehicle Operations (Romulan Shuttle) 1 (2)
 World Knowledge (Romulus) 1 (2)

ADVANTAGES/DISADVANTAGES

Cohort (Proconsul Kota) +5
 Contacts (Romulan Military) +3
 Favor Owed +5
 Resolute +3
 Security Clearance +5
 Arrogant -1
 Code of Honor (*D'era*) -3
 Obligation (Romulan Military) -3
 Vengeful (Klingons) -2

GLORY: 180

REOWN: 206

Aggression: 49 Discipline: 70 Initiative: -16

Openness: -10 Skill: 61

WOUND LEVELS: 2/2/2/2/2/0

The Praetor of the Romulan Star Empire, Champion of the Romulan People, Guiding Star of *D'era*, and Supreme Commander of the Romulan Star Navy is Neral, a formidable politician who has held his position for little more than a year.

Neral started out as the son of a Romulan senator and the representative of an influential family on Romulus. His father taught Neral from a young age the intricacies of Romulan politics and encouraged him to excel both physically and mentally. After his *Serona*, Neral chose a career in politics, serving on his father's staff. His career was an illustrious one, as he gained a reputation not only for mastering a wealth of details but also for his skill at political intrigue.

He quickly assembled a network of contacts and informants, which kept him apprised of current Imperial policy and the shifting political fortunes among the numerous senatorial colations. His political connections served him well with the passing of his father; the Jaridan Coalition sponsored Neral to

take his father's place in the Senate. At the time, critics whispered that the Jaridan had no choice—Neral knew where all their skeletons were buried. It was said that even the *Tal Shiar* feared Neral's influence and power, although that is probably a bit of an exaggeration.

Yet Neral's life has not been a perfect story of only triumphs and success. In 2349, Neral's wife and two children were killed in a Klingon raid on a Romulan colony. The three had been on the planet for a vacation, visiting her relatives. The loss changed Neral. While always ambitious, Neral threw himself into his work in an attempt to hide his pain.

He also became perhaps the most outspoken proponent for the military in the Jaridan Coalition (a group famous for its support of the military). He voted numerous times to allocate more resources to the Romulan Star Navy, and sided doggedly against resolutions calling for a scaling back of Romulan expansion. Each Klingon attack on Romulan citizens inwardly hardened his resolve against the Klingon Empire; he supported *Tal Shiar* efforts to destabilize the Klingon Empire through the actions of agent Sela.

Neral served for a number of years as the Proconsul of the Romulan Senate. During his tenure, he managed to hold on to the position through a combination of effective management and guile. Neral astutely guided the Senate's agenda, ensuring that the military and *Tal Shiar* received adequate funding and coopting his rivals' initiatives. He continued to use his network of operatives (now expanded) to keep tabs on potential plots to unseat him. Senator Trebiak's arrest for disloyalty to the Romulan Empire is seen by many as the result of one such plot. As a result, Neral served the longest term as Proconsul in the Senate's history.

With the death of the previous praetor, Neral seized yet another opportunity for political advancement. He had demonstrated his loyalty to the Empire through his many legislative initiatives, as well as his well known hatred for the Klingon Empire. He had the support of both the military and the *Tal Shiar*, as well as numerous senators spanning the political spectrum (after calling in a few favors and, some say privately, making a few well backed threats).

Thus, it came as no surprise when voices from the Senate floor nominated him to be the new praetor; after only minimal debate, the Continuing Committee swiftly confirmed the new choice. Neral even refused the office the first time, leading to a great public outcry and a concerted effort among the populace encouraging him to take up the role. Finally, with considerable humility, in front of both the Senate and the Romulan people, Neral accepted the great honor and was confirmed as the Empire's new Praetor, given the responsibility of guiding the Roman people.

Thus far, Praetor Neral has remained popular in the eyes of the Romulan people, although it remains to be seen if he will continue to such widespread support in the future. Although he supports the recent alliance with the Federation in response to Dominion attacks, he does not approve of it. Instead, ever the politician, he's adopted a "wait-and-see" attitude, counting on the Federation's best nature.



Senator Kassus

ATTRIBUTES

Fitness 2
 Strength +1
 Vitality +1
 Coordination 3
 Intellect 3
 Perception +1
 Presence 3
 Empathy -1
 Psi 0

SKILLS

Administration (Romulan Star Command) 3 (5)
 (Romulan Government) (4)
 (Starship Administration) (5)
 Athletics (Running) 1 (3)
 Command (Warbird) 3 (5)
 Computer (Research) 1 (3)
 Culture (Romulan) 2 (3)
 Dodge 2
 Energy Weapon (Disruptor) 2 (4)
 History (Romulan) 1 (2)
 Intimidation (Bluster) 3 (4)
 Language
 Romulan 3
 Law (Romulan) 1 (4)
 (Romulan Military Regulations) (2)
 Personal Equipment (Tricorder) 2 (3)

Planetside Survival (Forest) 1 (2)
 Politics (Manipulation) 4 (5)
 Shipboard Systems (Command) 2 (4)
 Social Science (Political Science) 1 (3)
 Starship Tactics (Federation) 1 (2)
 (Planetary Support) (2)
 (Romulan Tactics) (3)
 Strategic Operations (Invasion Strategies) 2 (3)
 Systems Engineering (Computer) 1 (2)
 Unarmed Combat (Romulan Navy Martial Arts) 2 (3)
 (Tenalri) (3)
 Vehicle Operations (Shuttle) 1 (2)
 World Knowledge (Romulus) 1 (2)

ADVANTAGES/DISADVANTAGES

Bold +1
 Cohort (Admiral Sojah)
 Contacts (Kassus' fleet) +3
 Famous Incident (Suppression of Breen Pirates) +1
 Security Clearance +3
 Arrogant -1
 Code of Honor (Code of *Ket-cheleb*) -3
 Obligation -3 (Romulan Military)
 Power-Hungry -1

GLORY: 126

RENOWN: 152

Aggression: 42 **Discipline:** 48 **Initiative:** -10
Openness: -16 **Skill:** 36

WOUND LEVELS: 3/3/3/3/3/0

Senator Morror Kassus is an ambitious man, yet most of his peers have no idea just how ambitious. A powerful figure in the Romulan Senate, Kassus wants to be nothing less than the Praetor of the Romulan Star Empire.

Kassus is the current head of the Kassus family, a family with a long history of service to the Empire. As a child, he learned the basic skills necessary to every warbird commander at his uncle's side. His father was a famed warbird commander in his own right, and eventually the boy served during his *Serona* under his father's command.

Kassus spent many years serving in the Romulan Star Navy, rising to the rank of Admiral. He was well known for his aggressive and decisive battle plans, and his devotion to the ideals of *D'era*. Admiral Kassus added many worlds to the Romulan Empire and oversaw many successful campaigns. Eventually, as a reward for his service, the Senate offered him a seat in their august forum.

Kassus accepted the offer, although he continued to maintain his old military contacts, as well. Kassus retains considerable influence within the Romulan Star Navy (including his personal senatorial fleet)

and could call up an entire legion of troops if he needed them to serve his interests.

Kassus sees an opportunity with the recent installation of a new praetor. He believes the new praetor remains weak, not yet able to consolidate his support and solidify his hold on the office. The senator has been working on ways to strengthen his power and influence within the Senate, mostly through military operations against the enemies of the Empire, like the Federation. If he can engineer a few spectacular victories for the Empire, Kassus hopes to elevate himself into a position where he can become Praetor, either by calling for the still-vulnerable Neral's removal, or through a cleverly plotted assassination.

To these ends, Kassus has been using his influence within the Romulan Star Navy, as well as cultivating extensive contacts within the *Tal Shiar*. In an attempt to placate hawkish admirals in the military, as well as to cover himself in glory, Kassus attempted to orchestrate the hostile takeover of a planet in Federation space (detailed in the adventure *A Fragile Peace: The Neutral Zone Campaign, Vol. I*), for which he received some criticism from his fellow Senators.

He currently plots to frame Senator Tomek, the most vocal of Kassus' critics, as a traitor, and sacrifice him on the *Tal Shiar's* altar. That Tomek is an innocent, loyal citizen of the Empire concerns Kassus little. He presents an obstacle in the way of Kassus' ambition, and must be removed in the most efficient way possible. If this manages to further Kassus' reputation in the bargain, so much the better.

Once he is Praetor, Kassus plans to use the power he has gathered to strengthen his role. His Praetorian Guard will be the largest and most powerful ever, and his influence over the *Tal Shiar* will allow him to ferret out those who would oppose his rule and eliminate them. His power as Praetor will be supreme, and no longer will the Romulan Empire be forced to hesitate when it can act and seize opportunities that the Senate's endless debates allow to slip away.

In a Romulan campaign, Senator Kassus is best suited as a powerful enemy for the player characters. They can begin by brushing against the outer edges of Kassus' plans. Anyone who discovers the truth about Kassus' ambitions is a target for discrediting and death, so characters may find themselves hunted by the *Tal Shiar* and facing powerful political opposition if they go up against Kassus unprepared.

Fighting the senator will require shadowy plotting and manipulation in the finest Romulan style. Who knows? Some character might even find the senator's view of a new Imperium quite attractive. Others may decide that Kassus presents a threat to both the Empire and *D'era*, and make it their sworn duty to defeat or disgrace him.

In a Federation campaign, Starfleet characters are certain to encounter some of Kassus' plots aimed at Federation worlds. They may even be contacted by elements within the Romulan Empire who need outside aid to bring about the senator's downfall and foil his plans, since no one within the Empire can be entirely trusted. Such a scenario might be an interesting way to bring two sets of player characters (Romulan and Starfleet) together for a particularly harrowing adventure!



Senator Merek

ATTRIBUTES

Fitness 2
 Strength +1
 Coordination 2
 Intellect 2
 Perception +1
 Presence 2
 Empathy -1
 Psi 0

SKILLS

Administration (Logistics) 1 (2)
 (Romulan Government) (4)
 (Starship Administration) (3)
 Athletics (Lifting) 1 (2)
 Charm (Influence) 2 (3)
 Command (Starship Command) 3 (4)
 Computer (Research) 3 (4)
 Culture (Romulan) 2 (3)
 Diplomacy (Interstellar Law) 2 (3)
 Dodge 3
 Energy Weapon (Disruptor) 2 (4)
 Fast Talk 2
 First Aid (Romulan) 1 (2)
 History (Romulan) 2 (3)
 Intimidation (Cross Examination) 2 (3)
 Language
 Romulan 3
 Life Sciences (Botany) 1 (2)
 Law (Romulan) 1 (3)
 (Romulan Military Regulations) (3)
 Personal Equipment (Tricorder) 1 (2)
 Persuasion (Debate) 3 (4)
 Physical Sciences (Physics) 2 (3)

Planetary Tactics (Small Unit) 2 (3)
 Planetside Survival (Jungle) 1 (2)
 Politics (Intelligence) 2 (3)
 Security (Law Enforcement) 2 (3)
 Shipboard Systems (Tactical) 2 (4)
 Starship Tactics (Federation) 2 (3)
 (Romulan) (3)
 Strategic Operations (Invasion Strategies) 2 (3)
 Systems Engineering (Cloaking Device) 1 (3)
 Unarmed Combat (*N'delrek*) 2 (4)
 Vehicle Operations (Shuttle) 2 (3)
 World Knowledge (Romulus) 1 (3)
 (Tigelis VII) (3)

ADVANTAGES/DISADVANTAGES

Cohort +2 (Romulan Commander)
 Contact (Military Commander) +2
 Contact (Senator Chatak) +3
 Curious +1, Security Clearance +1
 Code of Honor (Code of Fidelity) -3
 Dependents (family) -2
 Obligation -3
 Obsessive Tendencies -3
 Watched -2

GLORY: 115

RENOUN: 149

Aggression: 34 **Discipline:** 40 **Initiative:** 20

Openness: 14 **Skill:** 41

WOUND LEVELS: 2/2/2/2/2/0

Senator Jollen Merek grew up on the Romulan colony world of Tigelis VII in the Tiber Sector, an older colony world with a rich and illustrious history. Merek's family was one of the first to settle Tigelis, and held considerable influence on that world. It was little surprise the young scion of the family rose to prominence. Merek did everything to honor his ancestors and his family name, enlisting in the Romulan military and serving several distinguished tours of duty before entering Romulan politics as an aide to his uncle, the Senator of Tigelis. In a few short years, it became clear that many of the aging senator's most innovative and clever ideas came from his aide, and when his uncle retired to the family estate on Tigelis VII, Merek succeeded him.

For almost thirty years, Merek has served as a Romulan senator, and he is well known for his reputation for innovation and openness to new ideas. While some in the Senate admire Merek's abilities, others wonder if the senator's open-mindedness may eventually lead him into trouble. They fear his involvement with dangerous ideas might one day lead him down the path of sedition. Fortunately for Merek, his loyalty is unquestionable and his record is spotless. Even the *Tal Shiar* can find no evidence of any disloyal or treasonous behavior on his part.

The senator was away from Tigelis VII attending to Senate business when Phyxox Plague first broke out on the planet. By the time the Romulan authorities began efforts to contain it, the disease had spread like wildfire throughout the planet's population, then

began spreading to other worlds in the sector. The Senate quarantined the Tiber Sector, restricting travel to and from the affected region, and even Senator Merek has been unable to return home.

He communicates regularly via subspace radio with his family, a wife and three children, who currently remain safe at the Merek family estate. Conditions on Tigelis and throughout the Tiber Sector continue to deteriorate rapidly. As the plague claims more and more victims, riots and civil disobedience become more common. Romulan troops continue to do their best to maintain order, but they are short-handed; despite their best efforts at containment, some have come down with the disease themselves. If something is not done soon, the entire sector may erupt into mass panic that could increase the already high death count. Senator Merek fears for the lives of his family trapped on Tigelis, and for the lives of his people, who look to him for guidance and protection.

Frustrated by the slow response of Romulan scientists and doctors attempting to treat the plague, Merek recently proposed a bold initiative before the Senate: request humanitarian aid from the United Federation of Planets. *Tal Shiar* reports have revealed that Starfleet successfully contained an outbreak of Phyxox Plague on Cor Coroli V. If so, then perhaps the UFP possesses a means of treating the disease unknown to Romulan medical science. The Federation has offered humanitarian assistance in the past and such a request on the part of the Romulan government could be an important gesture, Merek argued.

The Senate rejected Merek's proposal out of hand. The Empire could take care of its own citizens, without any help from the Federation or Starfleet, opponents argued. Merek was forbidden to bring up the suggestion again. In the light of his personal crisis, senators were willing to overlook his behavior. The *Tal Shiar*, however, placed Senator Merek under close surveillance. (Unknown to Senator Merek, the *Tal Shiar* has also attempted twice to obtain Starfleet files on Cor Coroli V, with no success.)

Merek remains a loyal Romulan, but he feels bitter and angry toward the Senate and the Empire for refusing his request for aid, and for their handling of the plague crisis. He knows the *Tal Shiar* watch him, so he must move carefully, but he is willing to do whatever is necessary to protect the lives of his family, the people of his homeworld, and the billions of other lives in Tiber Sector.

In a Federation campaign, Senator Merek might take the supreme risk and contact Starfleet on his own, informing them of the situation in Tiber Sector and requesting their help. Of course, Starfleet might refuse, particularly since the Romulan government has made no official request for aid in what is an internal matter. For this reason, Merek may lie to the Federation about his authority to contact them, leaving any Starfleet personnel who do intervene in an awkward position.

In a Romulan campaign, Senator Merek may call in favors from his military and political contacts to find Romulan officers willing to violate the Senate's orders and go to the Federation to get the information and medical supplies needed to treat the plague. Such a mission could easily end the careers of the officers involved, unless they are successful and become public heroes, in which case the Senate may prefer to bury the whole affair quietly.

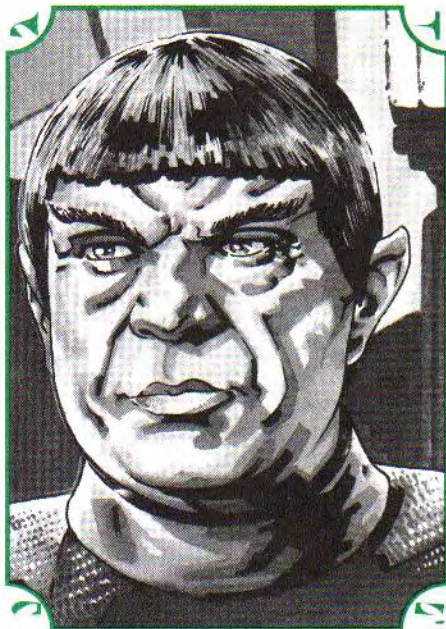

Senator Pardek

ATTRIBUTES

Fitness 2
 Strength +1
 Coordination 2
 Intellect 4
 Presence 3
 Willpower -1
 Psi 0

SKILLS

Artistic Expression (*Sirune*) 3 (4)
 Administration (Romulan Courts) 5 (6)
 (Romulan Government) (6)
 Charm (Influence) 4 (5)
 Computer (Research) 3 (4)
 Culture (Romulan) 2 (5)
 Diplomacy (Commercial Treaties) 4 (5)
 (Federation Law) (5)
 Dodge 2
 Energy Weapon (Disruptor) 2 (3)
 Espionage (Counterintelligence) 3 (4)
 Fast Talk 3
 History (Romulan) 4 (5)
 Intimidation (Cross Examination) 4 (5)
 Language
 Federation Standard 3
 Romulan 3
 Vulcan 1
 Law (Contract) 4 (5)
 (Romulan Military Regulations) (4)
 (Romulan) (5)
 Mediation (Civil) 3 (4)
 (Contracts) (4)
 Persuasion (Debate) 5 (6)

(Oratory) (6)
 Personal Equipment (PADD) 3 (4)
 Politics (Intelligence) 5 (6)
 (Manipulation) (6)
 Primitive Weaponry (*Neca*) 3 (4)
 Search 2
 Security (Dissident Operations) 4 (5)
 Social Sciences (Political Science) 4 (5)
 (Sociology) (5)
 Stealth (Stealthy Movement) 2 (3)
 Strategic Operations (Neutral Zone Strategies) 3 (4)
 Streetwise (Locate Information) 4 (5)
 Unarmed Combat (Romulan Navy Martial Arts) 2 (3)
 World Knowledge (Romulus) 4 (5)

ADVANTAGES/DISADVANTAGES

Benefactor (Neral) +5
 Cohort (Brother) +2
 Contacts (Underground Leader) +2
 Contacts (Underground Member) +1
 Contacts (Romulan Government) +3
 Favor Owed +1
 Security Clearance +1
 Code of Honor (Personal Honor) -2
 Outcast (Reunification Movement) -2

GLORY: 102

RENEWN: 149

Aggression: 10 **Discipline:** 44 **Initiative:** 13

Openness: 24 **Skill:** 58

WOUND LEVELS: 2/2/2/2/2/0

Pardek is a senior Romulan senator with a long and illustrious career. Since the early settlement of the Romulan homeworld, Pardek's family has been influential in the Krocton Segment of Romulus. As a young man, Pardek took part in the peace conference on Khitomer in 2293, where he first met Federation Ambassador Spock, then an officer in Starfleet.

Pardek has served in the Romulan Senate for ninety years and is considered "a man of the people" by his constituents. Pardek is well known for taking strolls through the Krocton Segment when the Senate is in recess, speaking with the people and listening to their problems and concerns.

Throughout his career, he has built a reputation for himself as a reformer and a strong supporter of peace within the Romulan Empire. Romulan conservatives consider many of Pardek's proposed governmental reforms to be much too radical to enact, including the senator's efforts to provide the general public with a greater voice in how they are governed.

Pardek's politics have earned him no small number of enemies over the years, but the senator is so popular and widely known that few can move against him for fear of public backlash. To ensure his position, Pardek carefully keeps himself in the public eye and away from scandal, allowing him to continue to work for the greater good of the Romulan people.

His devotion to his duty and his nation is so great, in fact, that in 2368 Pardek agreed to take part in a Romulan plan to lure his old friend Ambassador Spock to Romulus as part of an invasion of Vulcan. Pardek contacted Spock on the pretext of setting up talks regarding a reunification between the Romulans and the Vulcans.

Spock logically deduced that Pardek had betrayed him, once he discovered someone within the Romulan underground had been leaking information to the Senate. Pardek did not apologize for his actions, which he felt were for the good of Romulus. His cooperation also ensured him certain favors from then Proconsul Neral, allowing Pardek to advance his own political causes in the Senate.

Even though the invasion attempt was unsuccessful, and Pardek's involvement is known only in certain circles of the Romulan government, it was sufficient further to secure his position in the Senate and to quell many of Pardek's political enemies.

His position secured once again, Pardek resumed his work to bring peace and prosperity to the Empire. He is most concerned about the Romulan Empire's recent travails and wars, particularly the war against the Taurhai and relations with the Federation. Although he believes firmly in the ideals of *D'era*, Pardek thinks the Empire's reach may have exceeded its grasp in some ways.

He calls for an extensive consolidation of current Romulan holdings and protectorates, the quelling of rebellion among the people and various client species, and an easing of the hardships and shortages the Romulan people suffer in the name of greater military spending. Pardek still lacks the influence to achieve all of his goals, but the favor of the new Praetor may go a long way in the right direction.

In a Romulan-based campaign, Senator Pardek could be an influential and unusual patron for a group of player characters, particularly those loyal to the Empire who believe in the cause of peace and greater stability. Pardek might also choose to act as mentor to Romulan military or political characters who show promise, working to bring them over to his camp and show them the importance of his work.

Even radical characters might find themselves in contact with Pardek. He has traded on his reputation as "a man of the people" and a reformer to aid the authorities in capturing spies and rebels before, and he may well do so again. While characters associated with dissident movements may not always agree with Pardek's methods, most can't help but admire his legendary composure and sense of presence.

Federation characters might meet Pardek in a diplomatic capacity. The senator has extensive diplomatic experience dating back to the Khitomer conference, and he has contacts throughout the Federation and even the Klingon Empire (although the Klingons don't like Pardek, they do at least respect his influence).

The senator might be sent as an emissary of the Romulan Empire to negotiate a particular agreement, or to feel out the Federation/Klingon alliance about a possible informal alliance against the Borg.



Major Sela

ATTRIBUTES

Fitness 2

Strength +1

Coordination 3

Intellect 3

Perception +1

Presence 3

Willpower +1

Psi 0

SKILLS

Athletics (Running) 1 (2)

Behavior Modification (Brainwashing) 2 (3)

Command (Combat Leadership) 2 (3)

Computer (Hacking/Data Alteration) 3 (4)
(Programming) (4)

Culture (Romulan) 2 (3)

Dodge 2

Energy Weapon (Disruptor) 2 (4)

Espionage (Counterintelligence) 2 (4)

(Intelligence Techniques) (5)

(Traffic Analysis) (3)

History (Romulan) 1 (3)

Intimidation (Bluster) 4 (5)

(Cross Examination) (6)

Language

Romulan 2

Law (Romulan) 1 (2)

(Romulan Military Regulations) (2)

Medical Sciences (Psychology) 1 (3)

Personal Equipment (Tricorder) 2 (3)

Planetary Tactics (Small-unit) 2 (3)

Search 3

Security (Security Systems) 2 (4)

Shipboard Systems (Command) 1 (2)
 (Tactical) (3)
 Stealth (Hide) 1 (2)
 Surveillance (Electronic) 1 (2)
 Unarmed Combat (Romulan Navy Martial Arts) 1 (3)
 Vehicle Operations (Shuttle) 1 (2)
 World Knowledge (Romulus) 1 (3)

ADVANTAGES/DISADVANTAGES

Benefactor (Father) +3
 Famous Incident +5
 Favor Owed +1
 Mixed Species Heritage +6
 Security Clearance +3
 Fanatic -2
 Obligation -3
 Vengeful -2

GLORY: 54**RENOWN:** 69**Aggression:** 22 **Discipline:** 17 **Initiative:** -5**Openness:** -10 **Skill:** 15**WOUND LEVELS:** 2/2/2/2/2/0

If anyone in the known galaxy has claim to an unusual birth or parentage, it is Sela, a major in the *Tal Shiar*. Her story begins with the Romulan attack on the Klingon outpost at Narendra III in 2344. The Federation starship *Enterprise NCC 1701-C* attempted to aid the outpost, but, horribly outgunned, the ship suffered defeat. During the battle, a Romulan general captured several members of the *Enterprise-C's* bridge crew, among them Lieutenant Tasha Yar. Yar came from twenty years in the future, from an alternate timeline where the Federation fought a losing war with the Klingon Empire. The *Enterprise-C* ventured into this alternate future through a temporal rift.

Lieutenant Yar volunteered to go back in time to help the *Enterprise's* crew, in the hopes of altering history and preventing the war with the Klingons. Ironically, the crew of the *Enterprise-D* determined that their timeline was incorrect by the existence of Tasha Yar—the “real” Yar had died years ago on Vagra II. Thus it was this alternate Yar who traveled back in time and straight into the hands of the Romulans.

The Romulan general agreed to spare the lives of the surviving crew members if Lieutenant Yar agreed to be his consort. Yar did, and the *Enterprise's* bridge crew was sent to a Romulan penal colony. A year later, Sela, Yar's daughter, was born.

(That Yar came from twenty years in the future, and from an alternate timeline, perhaps remained a secret. Sela apparently knew her mother was a Starfleet officer, but it remains unclear whether or not she knew the whole story. Certainly, Lieutenant Yar would not have widely shared her origins, for fear of tampering with the future, even though she knew she came from an alternate timeline.)

When Sela was four, Yar tried to escape Romulus with her (perhaps in a futile attempt to free her for-

mer comrades). Sela cried out, warning the household. Her mother was killed fleeing the estate by the General's guards. Sela claims that everything human in her died along with her mother. She has considered herself completely Romulan from that day forward.

Sela joined the *Tal Shiar*, perhaps in an effort to demonstrate her loyalties to the Empire. Her ambition and her zealous hatred for the Federation made her a prominent figure in several Romulan operations conducted against the Federation in recent years. In 2367, Sela oversaw the assassination attempt against Klingon Governor Vagh, designed to foster distrust between the Federation and the Klingon Empire. Later that year, Sela commanded a Romulan task force providing covert support to the Duras family in the Klingon Civil War. The Romulan ships were forced to withdraw after a Federation fleet successfully blockaded the Romulan/Klingon border, preventing supplies from reaching the Duras faction.

Sela also masterminded the use of the Romulan underground resistance as a tool for the invasion of Vulcan in 2368. She conspired with Senator Pardek to lure Federation Ambassador Spock to Romulus while Romulan agents acquired Vulcan ships that would carry a Romulan invasion force. Sela's plan was thwarted by the efforts of Starfleet.

Major Sela is a highly ambitious woman with a considerable grudge against the United Federation of Planets (whether because they never mounted a rescue of the *Enterprise's* crew, which may have spared her mother's life, or because she feels she has something to prove remains unknown). Though she is devoted to Romulan goals and ideals, her half-human heritage and the stigma of her mother's treason forced Sela to drive herself harder than other Romulan officers to excel.

She is outwardly cold and ruthless, although given to outbursts of anger when provoked. Secretly, Sela feels guilt over the death of her mother. She knows that what Yar tried to do was wrong, but she feels that, if she hadn't cried, her mother would still be alive. Attempts to appeal to Sela's humanity usually invoke this buried guilt and anger her.

Major Sela makes a very useful and unusual Romulan adversary for Federation or Klingon characters. She is the quintessential Romulan plotter: devious, subtle, and patient, working behind the scenes to achieve her goals. Sela knows well enough to retreat when a plan has failed, and she rarely underestimates her opponents. Sela can be the prime mover behind any number of Romulan plots, and a long-term adversary. Her current whereabouts, and her role in the Federation-Romulan alliance, remain unknown.

For Romulan characters, Sela may be an ally, a commanding officer, or even a rival. Sela's ambitious rise to power has earned her friends and enemies in the *Tal Shiar*, military, and government. Characters who work with her have a chance to share in her success, but also in her failures, and they may become the targets of Sela's frustration if things do not go as planned. Romulans serving under Major Sela are almost always guaranteed interesting missions from time to time. Those Romulans who have Sela as an enemy have to deal with a cunning and dangerous opponent.



Captain Seylar

ATTRIBUTES

Fitness 2
 Strength +1
 Coordination 2
 Intellect 2
 Perception +2
 Presence 2
 Empathy -1
 Psi 0

SKILLS

Artistic Expression (Acting) 1 (4)
 (Vulcan Lute) (2)
 Athletics (Climbing) 1 (2)
 Behavior Modification (Resistance) 1 (3)
 Computer (Hacking/Data Alteration) 3 (4)
 Culture (Romulan) 2 (3)
 (Vulcan) (4)
 Disguise (Vulcan) 1 (5)
 Dodge 3
 Energy Weapon (Disruptor) 2 (4)
 Espionage (Covert Communications) 2 (3)
 (Intelligence Techniques) (3)
 First Aid (Romulan) 2 (3)
 History (Romulan) 2 (3)
 (Vulcan) (3)
 Intimidation (Torture) 2 (3)
 Language
 Romulan 3
 Vulcan 3
 Law (Romulan) 1 (2)
 (Romulan Military Regulations) (2)
 Medical Science (Physiology) 1 (3)
 Personal Equipment (Communicator) 3 (4)
 Primitive Weaponry (Knife) 1 (2)

Security (Security Systems) 2 (3)
 Shipboard Systems (Tactical) 1 (2)
 Social Sciences (Archeology) 2 (3)
 Streetwise (Locate Information) 2 (4)
 Surveillance (Shadowing) 3 (4)
 Systems Engineering (Weapons) 2 (3)
 Unarmed Combat (Romulan Navy Martial Arts) 1 (3)
 Vehicle Operations (Shuttle) 1 (2)
 World Knowledge (Romulus) 1 (3)
 (Vulcan) (3)

ADVANTAGES/DISADVANTAGES

Alertness +2
 Deep Cover +2
 Eidetic Memory +3
 Security Clearance +1
 Arrogant -1
 Dark Secret (Underworld Brat) -1
 Hides Emotions -2
 Sworn Enemy (*V'shar*) -2

GLORY: 40

RENOWN: 51

Aggression: 9

Discipline: 17

Initiative: 11

Openness: 0

Skill: 14

WOUND LEVELS: 2/2/2/2/2/0

Captain Seylar is an agent with the *Tal Shiar*'s Special Operations Division. After a childhood growing up poor in the slums of Val'danadex Trel, Seylar sees the *Tal Shiar* as a stepping stone to bigger and better things; she likes the power and prerogatives that come with her position, and is utterly devoted to the Romulan intelligence service.

Seylar was recruited for the difficult task of undercover operations within the Federation. She has been specially trained to impersonate a Vulcan, learning Vulcan customs and language, as well as to suppress her emotions and Romulan passions behind a cold, controlled facade. Her training has also given Seylar considerable willpower; it takes a great deal to crack her controlled, calm exterior.

Seylar was smuggled onto Vulcan and began her assignment, sending regular reports back to Romulus. So far she has not been caught; the Vulcans do not even suspect her, which has only deepened Seylar's disdain for the Federation. They are clearly as weak as she'd always been taught. At first, Seylar's surveillance turned up little of interest to the *Tal Shiar*.

The Vulcan Isolationist Movement eventually came to her attention. With its calls for the isolation of Vulcan from the rest of the galaxy, and the expulsion of non-Vulcans from their world, the VIM greatly interests the *Tal Shiar*. Her spymasters back on Romulus instructed Seylar to get close to the dissident movement and learn all she could about it.

She did so and eventually became a member. Expressing disdain for non-Vulcan cultures is not difficult for Seylar (it's merely an extension of her intolerance for non-Romulans), and she's managed to convince the isolationists that she is a loyal ally. (For more information on the VIM, see *The Way of Kolinahr: The Vulcans*).



Of particular interest to the *Tal Shiar* is the isolationists' desire to revive ancient Vulcan traditions and technology—particularly psionic technology—in use before the Romulan exodus. They believe that such technology may be the key to unlocking the latent Romulan psionic potential. Seylar has learned everything she can about Vulcan research into this area, studying ancient texts and archaeological information on Vulcan and Romulan ruins. She hopes to find a lead to some valuable information she can divert to the *Tal Shiar*, while subtly directing the isolationists to attack Federation targets.

In a Federation campaign, Seylar can become an adversary of Starfleet or Vulcan characters. At first, they may believe she is merely a Vulcan dissident, but if Seylar gains access to an ancient psionic weapon or similarly valuable information, she will do everything in her power to get it back to Romulus and into the hands of the *Tal Shiar*. The Federation would go to great lengths to keep the Romulans from developing new psionic weapons or technology.

In a Romulan campaign, Seylar might be in charge of a small group of undercover spies and operatives, directing them in espionage operations posing as Vulcans. She might call upon the characters to assist her in getting valuable intelligence back to Romulus. Finally, Seylar could also go rogue, becoming swayed by the isolationists' cause and betraying the *Tal Shiar*.

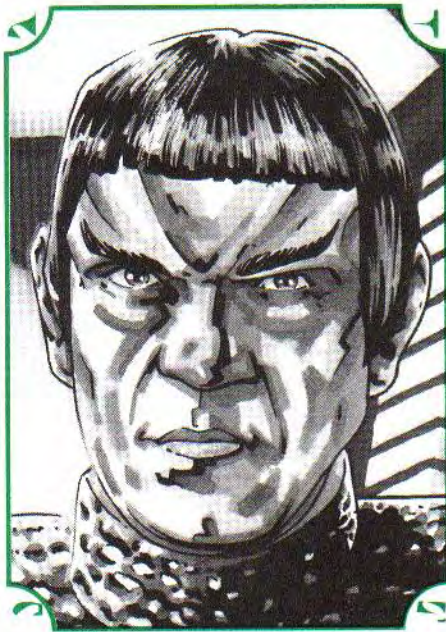

Commander Tomalak

ATTRIBUTES

Fitness 3
 Strength +1
 Coordination 2
 Reaction +1
 Intellect 3
 Logic +1
 Presence 2
 Empathy -1
 Psi 0

SKILLS

Administration (Starship Administration) 5 (6)
 Athletics (Lifting) 1 (2)
 Command (Starship Command) 4 (5)
 Computer (Research) 3 (4)
 Culture (Romulan) 2 (3)
 Diplomacy (Federation/Romulan Treaties) 3 (4)
 Dodge 2
 Energy Weapon (Disruptor) 3 (4)
 History (Romulan) 1 (3)
 Intimidation (Bluster) 2 (3)
 Language
 Romulan 2
 Law (Romulan) 1 (2)
 (Romulan Military Regulations) (4)
 Personal Equipment (Tricorder) 3 (4)
 Physical Sciences (Physics) 2 (3)
 Planetside Survival (Forest) 1 (2)
 Shipboard Systems (Command) 3 (5)
 (Tactical) (4)
 Space Sciences (Astrophysics) 2 (3)
 Starship Tactics (Planetary Support) 1 (3)
 (Romulan) (3)
 Strategic Operations (Neutral Zone) 3 (4)
 Systems Engineering (Command) 1 (2)
 Unarmed Combat (*N'delrek*) 2 (3)
 (Romulan Navy Martial Arts) (4)
 Vehicle Operations (Shuttle) 2 (3)
 World Knowledge (Romulus) 2 (3)

ADVANTAGES/DISADVANTAGES

Bold +1
 Commendation (Imperial Star) +2
 Commendation (Ribbon of Distinction) +1
 Commendation (Senatorial Award of Merit) +3
 Excellent Metabolism +1
 Famous Incident +1
 Innovative +1
 Arrogant -1
 Code of Honor (The Centurion's Oath) -3
 Obligation -3

GLORY: 72

RENEW: 100

Aggression: 20 Discipline: 24 Initiative: -13
 Openness: -15 Skill: 28

Wound Levels: 3/3/3/3/3/0

A skilled and well-regarded commander in the Romulan Star Navy, Tomalak began his career as a Romulan sublieutenant with unusual drive and a talent for taking initiative and assuming responsibility. His action during the war with the Taurhai earned Tomalak several commendations for bravery and valor. For his quick thinking and self-assuredness Tomalak received many choice duty assignments and several promotions. So far, he has risen to the rank of Commander, of the Romulan warbird *Terix*, and is assigned to the Federation Neutral Zone border.

In 2366, the *Terix* received a distress call from the Romulan scout ship *Pi*, which had suffered navigational failure and crashed on Galorndon Core, a barren planet in the Neutral Zone. Tomalak ignored the orders of the Federation starship *Enterprise-D*, then in orbit over Galorndon Core. He crossed the Neutral Zone to retrieve the crew of the scout ship. One crew member died on board the *Enterprise*, but the other was successfully recovered after a tense face-off between the *Enterprise* and the *Terix*.

Later that year, Tomalak again encountered the *Enterprise* when the Federation ship illegally entered the Neutral Zone to investigate reports of a Romulan incursion at Nelvanna III. The reports were a trick, engineered by the *Tal Shiar* and the Romulan government to lure the *Enterprise* into the Neutral Zone, making it appear that the Federation was the aggressor. Tomalak prepared a welcoming committee of two Romulan warbirds to capture the *Enterprise*. The plan was thwarted by the *Enterprise* bringing an escort of three cloaked Klingon birds of prey into the Neutral Zone with it, outmaneuvering the Romulan plan. Tomalak wisely withdrew, giving his respects to the *Enterprise's* Captain Jean-Luc Picard. Tomalak gained a great deal of personal respect for Captain Picard during this incident. He considers the Federation a worthy adversary and is eager to pit his experience and skills against those of Starfleet.

Tomalak loves the role of a commanding officer on the front lines of the Romulan Empire, and craves opportunities to demonstrate his initiative and cleverness to his superiors. He remains a firm believer in the ideals of *D'era*, a good soldier and a good commander, passionate about his cause and devoted to the people under his command. Although he is known for his willingness to take the initiative, Tomalak avoids risks that would place him or his crew in unnecessary danger. For him, brinkmanship is a complex and fascinating game, sometimes requiring strategic withdrawals. But he always returns to the front lines again, looking for new challenges.

In a Federation campaign, Tomalak makes a useful recurring adversary. His skill in negotiations and his willingness to call things off before they go too far can help ensure that Tomalak escapes and returns to encounter the characters again and again. Tomalak likes to toy with his opponents; as long as he has the upper hand, the Commander is also willing to gloat a bit. If the scales tip the other way, Tomalak is quick to cut his losses and withdraw. Alternately, the crew might encounter Tomalak and the *Terix* in a completely unexpected way: as an ally. With the alliance between the Federation and Romulan Empire, Tomalak could turn up in Federation space, fighting the Dominion alongside a starship crew.

In a Romulan campaign, Commander Tomalak is an ideal character to command a Romulan starship with the player characters as members of the crew. Romulan crewmen should find Tomalak a fair and capable commander, and Tomalak encourages initiative and responsibility among his crew, giving the characters an unusual degree of freedom on board the *Terix*. The crew can take part in Neutral Zone patrols along the border, maintaining order in neighboring sectors, and even covert operations within the Neutral Zone itself. Tomalak also makes a formidable rival or enemy for Romulan military characters who have earned his wrath, particularly those who dare to question the martial ideals that Tomalak holds dear.



Admiral Tovan

ATTRIBUTES

Fitness 3
 Strength +1
 Coordination 3
 Dexterity +1
 Intellect 3
 Perception +1
 Presence 4
 Willpower +1
 Psi 0

SKILLS

Administration (Romulan Star Command) 4 (5)
 (Starship Administration) (5)
 Artistic Expression (*Tillion*) 2 (3)
 Athletics (Climbing) 2 (3)
 Charm (Seduction) 2 (3)
 Command (Starship) 5 (6)
 Computer (Research) 3 (4)
 Culture (Romulan) 2 (4)
 (*Taurhai*) (3)
 Dodge 2
 Energy Weapon (Disruptor) 2 (4)
 First Aid (Romulan) 2 (3)
 History (Romulan) 1 (2)
 Language
 Romulan 2
 Law (Romulan) 1 (2)
 (Romulan Military Regulations) (5)
 Personal Equipment (Communicator) 1 (2)
 Persuasion (Oratory) 3 (4)
 Planetary Tactics (Small Unit) 2 (3)
 Planetside Survival (Jungle) 1 (2)
 Shipboard Systems (Command) 3 (5)

(Flight Control) (4)
 Social Sciences (Archaeology) 1 (3)
 Space Sciences (Astrogation) 3 (4)
 (Stellar Cartography) (4)
 Starship Tactics (Romulan) 4 (5)
 (Taurhai) (5)
 Strategic Operations (Invasion Strategies) 5 (6)
 Systems Engineering (Conn) 3 (4)
 Unarmed Combat (*Kormerek*) 2 (3)
 (Romulan Navy Martial Arts) (3)
 Vehicle Operations (Shuttle) 1 (2)
 World Knowledge (Remus) 2 (3)
 (Romulus) (3)

ADVANTAGES/DISADVANTAGES

Bold +1
 Cohort (Senator Vental) +5
 Commendation (Praetorian Ribbon) +3
 Contact (Romulan Military) +2
 Famous Incident (Battle of Chi'tan) +3
 Security Clearance +5
 Intolerance (Everybody Except Romulans) -3
 Obligation -3
 Rival (Admiral Ellivok) -2
 Species Enemy (Taurhai) -3

GLORY: 133**RENOWN:** 148**Aggression:** 47 **Discipline:** 41 **Initiative:** 0**Openness:** -15 **Skill:** 45**WOUND LEVELS:** 3/3/3/3/3/0

Admiral Tovan is a high-ranking Romulan military official, one with no small amount of influence in the Romulan Senate. Tovan's military career stretches back some eighty years, from the time he first entered the Romulan Star Navy for his *Serona*. Tovan found the military life to his liking and—filled with a strong desire to serve the Empire and bring honor to his family—he chose to remain after his required service expired.

Tovan continued as a helmsman on board Romulan starships for several years before earning a promotion to command. Once there, his strong leadership abilities became clear and he proceeded up the ranks to become prime officer of a variety of Romulan ships, and eventually commander of his own. His ship performed deep-space exploration and pacification, and Tovan oversaw the addition of many worlds to the Empire, including several where he saw extensive combat action against local military forces. His crews recognized him as a stern but fair commander with a brilliant tactical mind.

Tovan truly came to prominence in the war between the Romulan Empire and the Taurhai Unity. His vessel was one of the first Romulan ships able to engage a Taurhai stardragon, and Tovan was the first to destroy a Taurhai ship in combat. To accomplish this feat, Tovan came up with a radical, and dangerous, plan. His vessel had been crippled fighting the Taurhai—their weapons and technology were vastly superior to those of a Romulan warbird. Damaged,

adrift in space, the Romulan ship was finished. Knowing the Taurhai often simply crippled Romulan ships rather than destroying them, he ordered all remaining nonessential systems turned off to convince the Taurhai that his ship was completely disabled. He then assisted his ship's engineer in constructing a mechanism to launch the warbird's quantum singularity engine at the Taurhai ship.

The moment the Taurhai opened a subspace funnel, Tovan launched his crude "singularity torpedo." It collapsed the subspace funnel at a critical moment, and the gravimetric stresses tore the Taurhai ship apart. The Romulan Star Navy recently introduced a new missile weapon design to be used against the Taurhai in the event of renewed hostilities. Using base specifications derived from Tovan's maneuver, the new *Vereleus* class of dreadnoughts are the first vessels outfitted with these singularity torpedoes.

For his valor, Commander Tovan received a medal from the Praetor, while the Romulan Star Command promoted him and placed him in charge of the war effort against the Taurhai. Tovan carefully studied everything he could about this threat to the Empire. Although the Taurhai were powerful, Tovan believed they did not have the stomach for conquest and battle the Romulans did. The Taurhai were brave enough while they had the upper hand, but Tovan was certain that, struck a vital blow, the Taurhai would lose heart and the fight would go out of them.

Tovan proposed a bold plan: an attack on the Taurhai homeworld itself. He believed that a fleet of cloaked Romulan ships could reach Chi'tan and strike at the very heart of the Taurhai Unity. Although the Senate initially balked at committing Romulan forces in this way, Tovan won out and they agreed to his plan. The losses for the Romulan Fleet were high, but they secured victory in the war. The Taurhai agreed to meet and negotiate a peace treaty. Admiral Tovan was once again decorated by the Empire, and a statue was erected in his honor on Romulus.

Since the cease-fire with the Taurhai, Tovan, now an admiral, has turned his attention to the Federation. At first, with the discovery of a stable wormhole near the planet Bajor, Tovan drew up plans to invade the Federation and take this strategic prize. As reports filtered into Romulan space of a new threat—calling itself the Dominion—he began gathering as much strategic information as he could on these mysterious aliens.

When he heard rumors of a *Tal Shiar* fleet massing to invade the Gamma Quadrant with the Cardassian Obsidian Order, he believed the move had a high probability of success; after all, he'd advocated the same thing against the Taurhai. The destruction of the fleet disheartened him, as did continued Federation losses when the Dominion took the offensive in the Alpha Quadrant.

Currently, Admiral Tovan supervises the Romulan contribution to the Dominion War. With the recent alliance between the Federation, Klingons, and Romulan Empire, Tovan has been busy plotting Romulan military strategy, selecting targets, and charting ship assignments. Although he supports the alliance with the Federation, Tovan is not a fool. He observes Starfleet's military capabilities closely, and coordinates as needed with Starfleet officers, preparing for the battle for the domination of the Alpha Quadrant to come.

ROMULAN SERIES

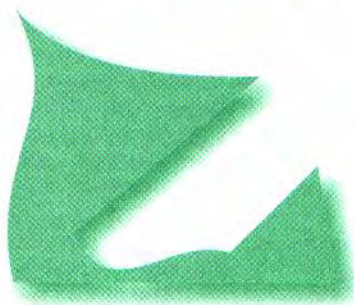

Creating a *Star Trek* series using the Romulans requires some modifications and additions to the information in “Chapter Eight: Where No One Has Gone Before” of the *Star Trek: the Next Generation Role-playing Game* core rulebook. Some of the themes and challenges of a Romulan-based series are the same, or at least similar, to those of a Federation-based one, but others are quite different.

A *Star Trek* series can involve the Romulans in two ways: a Romulan-centered series set in Romulan space with Romulan characters, or a series based around Federation or other foreign characters who interact with the Romulans. The first is probably the most challenging, because of the differences between Romulan and Federation viewpoints.

Romulan-centered Series

What if there were a *Star Trek* series produced entirely from the Romulan perspective? The series could follow the adventures of a Romulan warbird, out on the edges of known space, exploring, handling diplomatic missions, making contact with new races and discovering new worlds, just like the *Enterprise-D* on *Star Trek: The Next Generation*. What would such a series be like? How would the Romulans handle some of the problems encountered by the *Enterprise*? The Romulan-centered series attempts to answer just these sorts of questions.

This series is focused on the Romulans as the main characters of the story. It might take the form of the crew of a starship, much like the *Star Trek: The Next Generation* series, or it might follow other formats (see below). The key element is that the Romulans are the main characters, and the series should reflect not only their unique point of view, but also strong Romulan themes.

AXIOMS OF THE ROMULAN VIEWPOINT

Like other *Star Trek* stories, a Romulan series should contain cinematic action, opportunities for individual achievement, and triumphs of spirit and will over adversity, as described on page 162 of the *Star Trek: The Next Generation RPG* core rulebook.

The question of individual action and free will is a bit more complex when dealing with the Romulans. Romulan society is considerably more rigid and controlled than that of the Federation, so Romulan characters may be more limited in their choices. It is possible, however, to turn this to the advantage of the series by making the struggle between duty to the Empire and the need to do what is right a theme of its own. In the past, other Romulans have faced such crises of conscience. How will the player characters choose?

COMMON ROMULAN THEMES

Certain stories lend themselves well to a Romulan series. A Romulan series allows the Narrator and players to explore some “darker” themes that would not be appropriate in a Federation or Starfleet-based series, like wars of conquest, political intrigue, and so forth. These themes fit quite well into the Romulan point of view. Not every episode needs a meaningful theme, however. Stories might



THE DISSIDENT SERIES

For a change of pace, Narrators might want to run a series exploring the other side of the coin—the dissident movement. Players take on the rolls of disaffected Romulans, from merchants to military officers. (*Tal Shiar* agents might be inappropriate; they tend to be fiercely loyal. And a *Tal Shiar* spy PC pits players against each other). Players should choose an Overlay for their profession, then select one or more dissident background options during Background History. This gives characters a mix of skills, as well as establishing their “cover” (e.g., an intercessor and dissident, or soldier and dissident).

Most episodes should focus on the difficult life of a rebel. They skulk around, trying to avoid capture while trying to bring a new way of life to the Romulan people. One week, they might try to break fellow dissidents out of prison. Another week, they might help a defector escape to the Federation, or help a Federation agent sneak in. Dissidents might try to help members of a client species attain their freedom, or avoid the Romulan yoke altogether. Or they might try to convince a sympathetic senator to effect change.

focus on the mundane, day-to-day existence of a group of Romulan characters. For example, the officers on the *Enterprise-D* ran holodeck programs and got together for weekly poker games to relax. What do officers on board a Romulan ship do for recreation? If Federation citizens take vacations on Risa, where do Romulans go? If you’re a Romulan, what do you do on shore leave? These and other questions can make for an interesting change-of-pace episode or two.

DEFENDING THE EMPIRE

Loyalty to the Empire is a prime Romulan theme. Romulans emphasize the virtues of duty, honor, and service. This theme can range from fighting in a war to protect the Romulan Empire from a powerful threat like the Borg or the Taurhai, to a crew working to protect their ship, or even a Romulan vessel doing its utmost to safeguard the life of a single crewman, such as when Commander Tomalak’s warbird risked crossing the Neutral Zone to recover a Romulan centurion (in the *Star Trek: The Next Generation* episode “The Enemy”). Note that Romulans have a tradition of noble sacrifice in defense of the Empire. Such stories often possess a tragic element if a character is willing to make the ultimate sacrifice.

EXPLORATION AND CONQUEST

Like Starfleet, the Romulan Star Navy explores the galaxy, discovering new worlds and civilizations. Unlike Starfleet, the Romulans evaluate new worlds from the perspective of whether or not they can be conquered and added to the ever-expanding Empire. They do not concern themselves with issues like the Prime Directive. Romulans tend to be quite blunt in stating their intentions. If a newly encountered race defies the Empire, it must be taught a lesson. This means that Romulan exploration episodes are more likely to contain combats and space battles than Federation-based episodes.

This does not mean that every time the Romulans discover a new world, it is a simple matter of moving in, disruptors blazing, and taking over. The Romulans carefully evaluate a new world first, to see if it is of some value to the Empire, either as a potential colony site or as a client state. If so, then the Romulans make contact with the native inhabitants, if any. While a show of force may be necessary, a Romulan first-contact team must be careful to keep the natives in the dark about their intentions. Prematurely warning the inhabitants that the Empire intends to conquer them may make the eventual job of conquest a more difficult one.

Additionally, while the Romulans may possess superior technology, a single landing party can still be threatened by a less-advanced race that vastly outnumbers them. A handful of Romulans armed with disruptors versus hundreds of primitive aliens armed with spears can still result in significant Romulan casualties.

If the Empire does decide to annex a world, then the true campaign of conquest begins. This may be as simple as issuing an ultimatum to the planet’s populace, backed by a sufficient show of force to break any resistance, or it may require a military campaign of many ships and battles to overcome the species’ defenses. Some species join the Empire willingly, while others must be crushed under the force of its military might. A Narrator can turn a campaign of conquest into a short series of its own where the characters struggle to overcome the obstacles in the way of victory for the Empire.

The Romulans explore the frontiers of science as well as space. A Crew can become involved in the study of unusual phenomena, or in the testing of new technologies. The test of a new Romulan singularity drive or cloaking device might lead to an adventure when an unexpected effect of the technology catapults the ship out of the normal universe and into another place, dimension, or parallel reality.

INTRIGUE

“It’s always a game of chess” with the Romulans, as Captain Picard once said. The Romulan character lends itself to scheming, plotting, and intrigue. While the Federation is an open and honest society, the Romulan Empire is riddled with individuals who have their own agendas and the means to carry them out. The *Tal Shiar* is everywhere, watching for any

signs of disloyalty, and one wrong move can mean the end of a promising career. A Romulan series has a considerable edge of paranoia to it, mostly because everyone really is out to get everyone else.

Romulan characters need to deal with the constant surveillance of the *Tal Shiar*, and the issue of whether or not to report infractions on the part of their fellow Romulans, even friends and family. They can also become caught up in the various plots and schemes of high-ranking military officers, senators, intelligence agents, and underground rebels. Characters may wish to hatch some plots of their own, designed to advance a political agenda or simply secure more power for themselves.

The Narrator should take care to avoid setting the player characters against each other in intrigue plots. It is better to create plots that make the characters depend more strongly on each other because there is no one else they can really trust. A common enemy is an excellent way to unite a group of otherwise mistrustful Romulans.

It is also important not to let intrigue and scheming completely overshadow the series, unless you want a series based almost entirely on it, such as a *Tal Shiar* series (see page 58 of *The Romulans*). Plots and intrigues tend to take over a series quickly if there are too many or they are allowed to run out of control.

MORAL DILEMMAS

Romulan morality is not the same as that found in the Federation. Romulans believe they possess a moral imperative to conquer the galaxy and bring all races under their benevolent rule. They believe they have a duty to those under their protection, and act with a certain measure of honor.

There are times when a Romulan's duty and his conscience come into conflict. For example, a Romulan officer is ordered to arrest a group of political dissidents, only to discover that one of the dissidents is a woman he was in love with many years ago. Does he ignore his duty and warn her, or does he put aside his personal feelings and carry out his orders? Can one of the characters turn a friend over to the *Tal Shiar*? What if that friend really is guilty of treason? These are some of the tough choices Romulan characters have to make in this type of episode.

It is important when running Romulan episodes centered around moral dilemmas not to forget that the Romulan point of view is different. Many things a Starfleet officer would consider moral dilemmas, such as violating the Prime Directive, or conquering a newfound civilization, are not really dilemmas for Romulans, who do such things all the time. The key is to pit the character's personal feelings against his duty to the Empire. One excellent example from the *Star Trek: The Next Generation* series is the episode "The Defector", in which a Romulan admiral must choose between his loyalty to the Empire and his desire to avert a war which he thinks may destroy the Empire. Of such choices are dramatic stories made.

D'ERA

All the above themes are neatly summed up in the Romulan ideal of *D'era*. This is a primary theme that lies at the heart of all Romulan episodes. *D'era*

ROMULAN THEMES

Here are some sample story ideas for the common Romulan themes:

Defending the Empire

- The Romulans must overcome a threat to the whole Empire, like the Borg or the Taurhai.
- Romulans encounter a new race or technology that could prove a danger to the Empire.
- The Crew is dispatched on a diplomatic mission to protect the Empire's interests.
- One crewman's life is in danger and must be protected at great risk.
- Rebels or terrorists must be stopped.
- The Crew must rush aid to a disaster-struck portion of the Empire.
- A breakdown in the ship's systems—such as the quantum singularity drive or cloaking device—endangers the Crew.

Exploration and Conquest

- The ship encounters an undiscovered planet.
- The Crew encounters a new lifeform. Is it a threat to the Empire?
- A campaign of conquest against a new race on the fringes of the Empire.
- The Crew discovers an ancient artifact or alien technology.
- A spatial anomaly catapults the ship and Crew far outside of Romulan space, leaving them on their own.
- A temporal anomaly sends the Crew back into the past, to the early days of the Empire, or even to pre-diaspora Vulcan. Can they return without changing the past? Or should they change the past?

Intrigue

- The Crew is dispatched on a mission to further someone's political agenda without their knowledge.
- The Crew is infiltrated by a *Tal Shiar* agent assigned to monitor them.
- Foreign spies (Federation, Taurhai, or others) need to be rooted out.
- The Crew is caught between the political ambitions of two senators.
- The Crew aids the Romulan Rebellion, on their own or as part of a plot to expose the rebels.
- The ship must use its cloaking device to cross over into Federation space on a delicate mission.

Moral Dilemmas

- A crewman is forced to choose between duty and personal feelings.
- The Crew has conflicts with the orders of the Empire. Do they obey or do what they feel is right?
- A crewman must decide whether or not to pass information on to the *Tal Shiar*.
- An enemy (Federation, Taurhai) sincerely offers aid. Does the Crew betray them?

D'era

- Romulan ideals are challenged by an alien race and must be defended.
- The Crew helps a disgraced Romulan hero regain his honor and position in the Empire.
- A crewman makes the ultimate sacrifice for the good of the Empire.
- A crewman makes a difficult choice based on honor.



THE POLITICAL SERIES

The political series focuses on the politics and political infighting within the Romulan Empire. While the Romulans present a united front to outsiders, internally senators and coalitions vie for supremacy.

This series centers on politicians; players can play intercessors, diplomats, or senatorial aides working on a senator's staff (one of the players may be a senator, with enough Renown). Military officers might be assigned to provide protection or serve as advisors. A merchant might provide his services, as well. The series could be set on Romulus, as the group engages in political machinations and decides the course of the Romulan Empire. Stories might focus on digging up dirt against political enemies, uncovering a plot to divert resources from the military, or embarrassing a political rival. Who knows, one of the players might be propelled into the Proconsul's seat, or perhaps higher.

On the other hand, the series might be set on a Romulan colony (new or old). One of the players might serve as the governor, with the others playing his advisors and assistants. Or they might all work for a supporting cast governor. Several characters could be military officers, sent to protect the governor or help quell uprisings. *Tal Shiar* characters could join in, sniffing for a whiff of rebellion. Diplomats could serve as cultural experts and advisors. Episodes might focus on managing the colony, searching for dissenters, or political plots hatched back on Romulus.

is quite different from the Vulcan (and Federation) philosophy of IDIC, described on page 164 of the *Star Trek: The Next Generation RPG* core rulebook. The Romulans do not consider other civilizations and philosophies equal to their own. They believe they are the descendants of the Vhorani, an ancient civilization that created the Vulcanoid species and deposited it on the harsh world of Vulcan to make it strong.

Only the strong survive, and thrive, according to *D'era*. As the children of the Vhorani, and the keepers of their legacy, the Romulans believe they are destined to gather the galaxy's weaker species under their banner. Other civilizations must either acknowledge the truth of *D'era*, and accept Romulan rule, or be swept away.

This philosophy provides a certain clarity to a Romulan series. Players rarely need to concern themselves with issues of diversity and equality as in Federation-based series. They know they are Romulans, and therefore superior. On the other hand, *D'era* limits the opportunities for playing non-Romulan characters in a Romulan series. While Federation starships are crewed by members of dozens of different races, a Romulan series is about the Romulans, and no one else.

SETTINGS

The Romulan Empire contains a vast number and variety of different settings. There are hundreds of worlds, sectors of unexplored space, and numerous different cultural factions to take into account. A quick look through the information in this product shows only a portion of the vast scope of the Empire.

STARSHIPS

There are many different types of Romulan ships, from powerful warbirds to smaller scouts and everything in between. As in a Federation series, much of the action in a Romulan series takes place on board a ship. A Romulan starship can provide a mobile home base for a Crew to explore the galaxy and carry out glorious missions in the name of the Empire. Stories can also take place on board ship, making it an excellent backdrop for episodes about the characters' personal lives. Starships may encounter unusual phenomena, suffer from equipment malfunctions and damage, or be invaded by enemies or strange aliens.

Romulan ships have an additional factor to them that Federation vessels do not, namely the cloaking device. The cloaking device is a powerful tool enabling players to take tactical control of a situation, allowing them to break off conflicts and escape or avoid them altogether by remaining effectively invisible to opposing vessels. Of course, enemies of the Romulans have come up with ways to counter their cloaking devices in the past, and technical problems with the cloaking device can lead to some interesting stories.

OLD WORLDS

The heart of the Romulan Empire possesses innumerable fantastic worlds, including the homeworlds of Romulus and Remus. These older worlds are the center of Romulan culture and civilization, and are at the same time hotbeds of political intrigue and activity. A series could easily take place almost entirely on Romulus and Remus, focusing on the politics of the Empire and the activities of the Senate.

Romulan characters can also return to the core worlds of the Empire on business or simply for a visit to friends and family. Episodes set in the heart of the Empire should emphasize the grandeur and majesty of the Romulan homeworlds, and take advantage of their many unique features and attractions.

NEW WORLDS

The Romulan Empire includes hundreds of different worlds, each with unique features and challenges for a Romulan Crew to encounter. The worlds detailed in *The Romulans* provide examples and jumping-off points for Narrators to create new Romulan worlds of their own. A Crew can visit these worlds for various routine reasons (encountering all manner of adventure along the way), either to handle a specific problem or for other

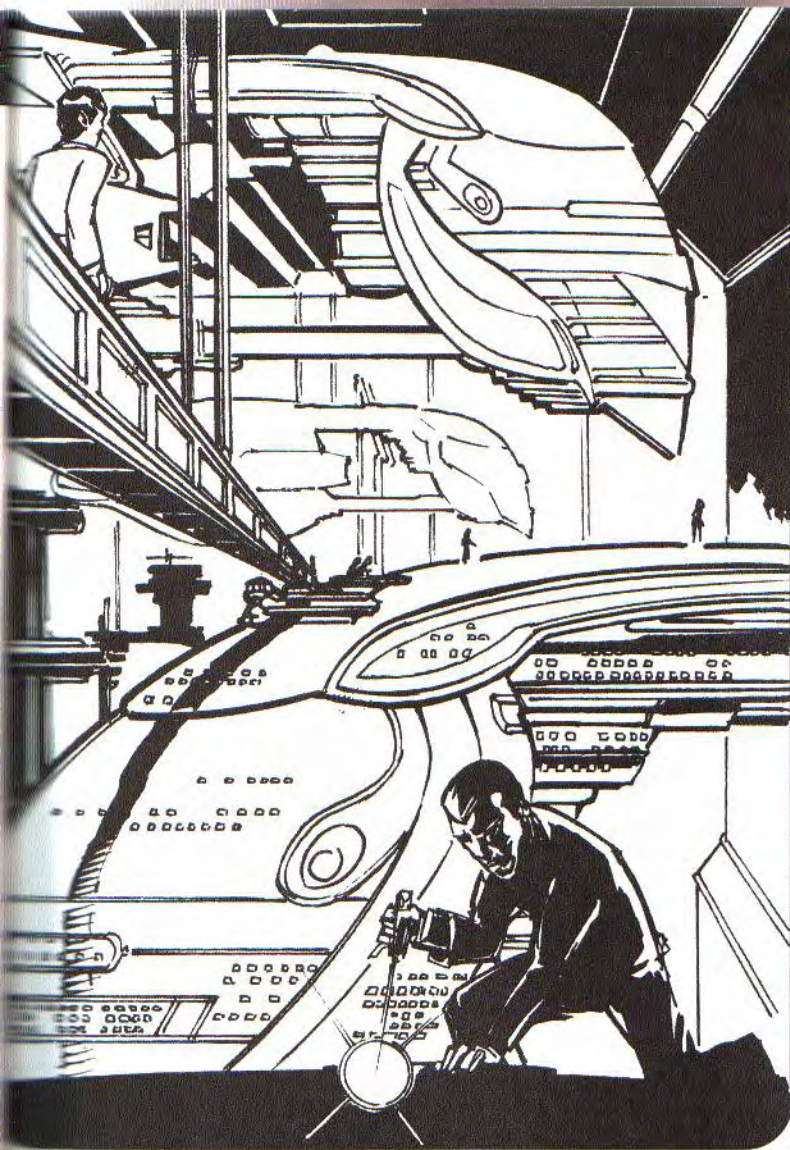

reasons. Narrators who wish to focus on specific worlds can have a Crew assigned there as part of a garrison or occupation force. For example, a series could be based around the Romulan conquest of Tegebaar; the characters would be forced to deal not only with a tense political climate, but also with the growing rebellion there.

An interesting series might be based on a new Romulan colony or outpost, with the players assuming the roles of the leaders or officers. The new colony would face challenges from the environment, native lifeforms (some of which may be intelligent), and unknown hazards of their new home. Perhaps the characters would even be charged with terraforming or “taming” the new world, in preparation for the arrival of colonists.

NEW FRONTIERS

Like the Federation, the Romulans explore the galaxy and push the borders of their Empire ever outward. A Romulan Crew can encounter virtually any sort of planet that a Federation Crew might, although the Romulans will most likely deal with their discovery differently. All the ideas in the *Star Trek: The Next Generation RPG* about “strange new worlds” and species apply equally well to the Romulans.

It can be quite interesting to take a familiar plot from a *Star Trek: The Next Generation* episode and replace the *Enterprise-D* with a Romulan vessel.

How would a Romulan crew handle some of the challenges faced by Picard and company?

Additionally, Romulan crews encounter more than just new planets. There are all manner of unusual spatial phenomena, from wormholes to quantum filaments to new things as yet undiscovered. A temporal phenomena could send a Romulan Crew forward or backward in time or into a parallel dimension. Imagine how the Romulans would react to a parallel universe where a Klingon/Cardassian Alliance has conquered the galaxy, turning Romulans and humans into allies against this alliance. The possibilities are limited only by your imagination.

FEDERATION-CENTERED SERIES

Of course, Romulans can also be used in a series in their traditional role as adversaries of the Federation. Information on the Romulans and their culture and goals can enhance the use of Romulan supporting characters in more traditional *Star Trek* series and episodes.

ROMULAN ADVERSARIES

Narrators can use material in this set for creating more detailed and interesting Romulan adversaries for a Federation Crew. A recurring Romulan nemesis—like Commander Sela or Commander Tomalak—can give the Romulans more personality and character in episodes than simply having them as faceless enemies. A good Romulan adversary should be someone the Crew can respect, and who eventually comes to respect them. The Romulans act with honor, and they understand the value of a worthy adversary. They also know the better part of valor and are likely to retreat in order to fight again another day.

An adversary is even better if you can provide occasional reasons for the Crew to work with their nemesis against some kind of common problem. Perhaps Federation and Romulan crews are stranded together by a spatial rupture, equipment failure, or the caprices of an entity like Q, forcing them to work together toward a solution. Or perhaps the Crew goes to represent the Federation at an interstellar conference and the Romulan representative turns out to be their old adversary. The players may find out some remarkable things about their “enemy” when forced to work with him.

ROMULANS IN THE FEDERATION

While the United Federation of Planets and the Romulan Empire may be enemies, that doesn't mean there aren't Romulans living in the Federation, or humans living in the Empire. Some are honest citizens, while others are intelligence agents engaged in espionage.

ROMULAN EXPATRIATES

Romulans have been known to defect from the Empire and settle in the Federation for various reasons, usually to have the kind of political and social freedom Federation citizens enjoy. Most of these “defections” are of little concern to the Empire, except for the bad example they set.



Unless a Romulan has sensitive information or materials, once he has left the Empire there is little likelihood of trouble from the *Tal Shiar* or other Romulan forces. On the other hand, important Romulans are carefully watched to prevent their defection. Still, some have succeeded in leaving the Empire and passing on military and technological secrets to the Federation.

It is quite possible a Romulan defector to the Federation might choose to serve Starfleet, the very embodiment of Federation ideals. The Federation and the Empire have been in contact for more than a century, so a Romulan citizen of the Federation may have parents or even grandparents who left the Empire for reasons of their own. Such a Romulan would never have even been to the Empire or seen his homeworld. Of course, there's always the possibility of Romulan crossbreed characters with the Mixed Species Heritage Advantage, particularly if the character's Romulan parent defected for reasons of love and family. One crewman on the *Enterprise* was revealed to be one-quarter Romulan during the series episode "The Drumhead."

While Starfleet does not officially discriminate against any applicant, a Romulan character living in the Federation may still face certain prejudices and presumptions. The Romulan Empire is considered an enemy of the Federation, so a Romulan character is likely to be viewed with suspicion by those who suspect he might be a spy or double agent. Starfleet runs the same background checks on Romulan applicants as they do on everyone, although a Romulan expatriate is viewed with a touch more suspicion than a Romulan who was born and raised in the Federation.

ROMULAN SPIES

The *Tal Shiar* takes advantage of the openness of Federation society and their acceptance of Romulan expatriates to place agents in the Federation. They gather information and report their findings back to Romulus. Most Romulan agents in the Federation pose as Vulcans, although the Romulans can surgically alter their agents to appear as humans or members of other humanoid species. Romulans posing as Vulcans need to be skilled actors to control their natural emotional impulses, but the *Tal Shiar* chooses only the most capable for missions of such importance.

A *Tal Shiar* spy could conceivably take on almost any role in the Federation. One spy successfully posed as a Vulcan diplomat for years before returning to Romulan space, so it is quite possible for a Romulan spy to be a Starfleet officer or other important official, perhaps someone already known to the Crew.

Players can run a group of Romulan spies operating in the Federation as part of a series, working together to gather information and avoid detection by the Federation authorities. The role of a Romulan double agent would also be an interesting one to play. Imagine when it is revealed that the "Vulcan" bridge officer of a Federation starship is actually a Romulan *Tal Shiar* agent!

What happens if the agent, through his contact with Starfleet officers, begins to question his mission and decides to turn against the *Tal Shiar*? Is there any way for the agent to escape from the long reach of the *Tal Shiar* without also destroying his Starfleet career and losing the many friendships he has built?

THE FEDERATION IN THE ROMULAN EMPIRE

Federation citizens defecting to the Romulan Empire are much rarer than the converse, but it has been known to happen. Some find the Romulan way of life simpler than the complex philosophies of the Federation. The Romulans have order and a clear sense of purpose that can be appealing. Most non-Romulans would find themselves second-class citizens in the Empire, unless they had some particularly useful information or skills they could provide. More likely are individuals from the United Federation of Planets and other worlds entering the Romulan Empire on business or for the purposes of espionage.

BUSINESS IS BUSINESS

The Romulan Empire takes part in interstellar trade, even with some worlds of the Federation. There are serious trade restrictions about goods

crossing the Federation/Romulan border; all ships are checked on both sides. Of course, this doesn't stop enterprising privateers and smugglers from trying to slip past Federation and Romulan patrols with, say, an illegal shipment of Romulan ale for sale in the Federation. For the most part, trade between the Federation and the Empire remains quite limited.

On the other hand, a number of third parties, including both the Ferengi and the Orions, trade actively with both the Federation and the Romulan Empire. This allows them to act as "middlemen" between the two states, keeping trade lines open and sending ships across the border into Romulan space.

Both the Romulans and the Federation carefully monitor ship traffic to ensure that traders are not used for smuggling, but there are simply too many vessels to check every single ship; a cunning trader can often find a means of getting into the Romulan Empire or the Federation secretly.

A free trading ship would make an interesting basis for a series featuring characters of different species, who could become entangled in political intrigue between different factions.

FEDERATION SPIES

Although the Federation doesn't talk about it much, they do employ intelligence agents to gather information vital to the security of the Federation and its allies. Federation spies have a considerably harder time in the Romulan Empire than Romulan spies do in the Federation. For one thing, a Federation spy must be disguised as a Romulan in order to blend in and gather any useful information. This usually means surgical alteration of human agents. Vulcans can pass as Romulan, but they cannot act Romulan without sacrificing their emotional control, something no Vulcan would do. Therefore, Federation agents can be detected by fairly routine scans and medical tests. Additionally, the constant presence of the *Tal Shiar* makes it difficult for any spy to operate in Romulan territory for long without being suspected and captured. Long-term spy missions into the Romulan Empire nearly always fail.

More common is for Federation agents to enter the Empire on a specific mission, accomplish it, then leave without being detected. Although the Treaty of Algeron specifically forbids the Federation from developing and using cloaking technology, Federation agents have "borrowed" cloaked Klingon ships in the past to get into Romulan space undetected. They also use trading vessels as a means to get across the Romulan border. It is not uncommon for the Federation to choose Starfleet officers for these missions, and a mission into Romulan space could be an interesting—and eye-opening—adventure for a regular Starfleet Crew.

For more information on Federation intelligence activities, see *The First Line: Starfleet Intelligence*.

New Rules

Playing a Romulan series involves two new mechanics, which Narrators should be familiar with: Renown and Glory.

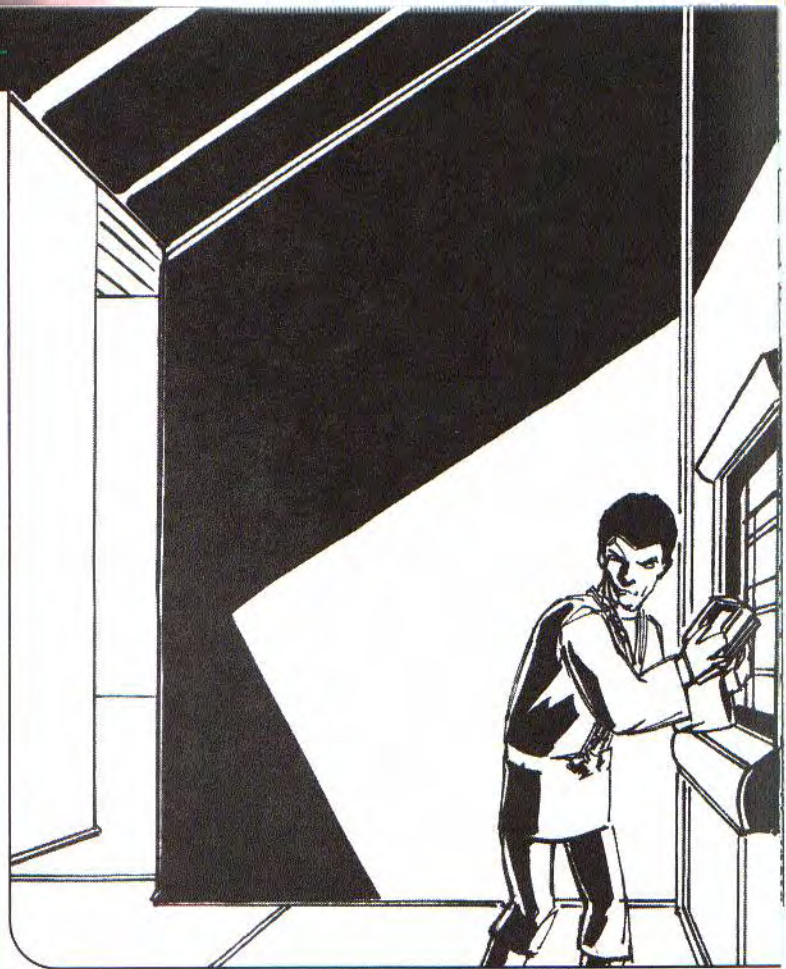

RENOWN

Romulans live in a privileged society where people gain prerogatives by virtue of their status. A soldier with friends in the Senate could find himself on the fast track to centurion, while a soldier without the right connections might languish for years on a backwater garrison world. At the same time, a Romulan citizen is measured by his deeds. Bringing a new world into the Empire, saving a senator from assassination, or outfoxing a Federation starship attracts favorable attention. With attention comes recognition. Thus, when running a campaign centered on Romulans, Renown becomes a much more important facet.

Renown affects a character's status in Romulan society. The more Renown a character earns, the more well known he becomes, the higher his rank in the military or politics, and the more political capital he has to expend. To get ahead in Romulan society takes having a favorable reputation, and reputations are made through action. It is entirely possible for a young, inexperienced character to go far in the Romulan Empire, as long as he exhibits the right attitude. A character with a lucky roll at the right time—saving a centurion's life with a dramatic success—can be promoted without possessing sufficient skill.

RENOWN AWARDS

Narrators should reward players with Renown points for good role-playing. The number of points depends on the character's actions during an episode. In general, if an accomplishment could conceivably garner a character attention, he earns Renown. While a character can earn Renown in any



ROMULAN RENOWN AWARDS

This table should be used in addition to the table on page 180 of the *ST:TNG* RPG core rulebook.

Defeating an enemy starship 1–2

Destroying an enemy starship 3–4

... in Romulan space +2–3

Obtaining ...

... sensitive information 1–2

... secret information 3–4

... top secret information 5–6

... information that could alter the course of galactic politics for decades to come 7–12

Placing the Empire's needs before your own 1–5

Stopping a rebellion 1–6

Substantially benefiting the Romulan people (e.g., saving flood victims, negotiating a treaty, discovering a working Iconian gateway) 1–8

Taking a personal risk

(e.g., endangering your life) 1–10

Uncovering a spy 1–2

... in Romulan space +1–2

... in a dangerous location in Romulan space +1

... in an extremely dangerous location in Romulan space +2

Uncovering and arresting a dissident 1–3

The dissident is a friend +1–4

The dissident is a relative +2–7

Uncovering and arresting a dissident cell (1 Renown per dissident present)

Catching Ambassador Spock 5–10

Example: *The group uncovers a cell of five dissidents, and each character receives 5 Renown. One of the dissidents is one of the characters' acquaintances from childhood; that character receives 6 Renown (5 + 1).*

Example: *A PCTal Shiar agent arrests a dissident. This dissident happens to be his own mother (7 Renown) and a dissident leader (+3 Renown), for a total of 10 Discipline Renown.*

Example: *A Romulan soldier displays skill in a skirmish with Tarquin rebels (2 Renown), and puts his life in danger by taking a disruptor blast meant for his commander (+4 Renown), for a total of 6 Skill Renown.*

of five aspects, Romulans value three traits in particular—Aggression, Discipline, and Skill. These traits form the essence of *D'era*, the Romulan manifest destiny that states that they, as children of the Vhorani, are destined to rule the Endless Sky. Those who emulate *D'era* through their actions can go far in Romulan society.

Although Experience Points and Renown both reward players for good role-playing, the criteria for awarding Renown points differ from Experience Point awards. A player, for example, might earn Experience Points for letting a crippled Taurhai stardragon escape destruction, because it fits his character's concept (as an honorable, almost noble, soldier). But such an action runs counter to *D'era*, and the character might not earn Aggression Renown (or might not earn as much as he would for destroying the stardragon). Experience Point and Renown Point awards will not always coincide.

Typically, Renown should be awarded only for truly distinguished actions, those that would earn respect and admiration (or envy), and which conform to *D'era*; the action should be something Romulans would celebrate and acclaim, bringing glory to the Empire and the Praetor. A character who simply remains at his post shouldn't earn much, or any, Renown. A character who remains at his post while the bridge of his warbird burns around him displays heroism and discipline, and should receive a Renown award. The Narrator is the final arbiter of when a Renown award is appropriate.

Renown can be awarded for a character's overall performance during an episode—for achieving the story's goals, for example—for individual actions during an episode, or for both, as the Narrator sees fit. The group might earn Skill Renown for successfully saving their ship, while one player might receive additional Aggression Renown for his determination. Similarly, while the group may not achieve the mission's goals—recovering an ancient Iconian artifact, for example—individual characters may have performed actions that improve (or harm) their reputations.

An action does not necessarily have to succeed to garner a character Renown. Sometimes, merely trying is enough. If, for example, the group attempts to acquire sensitive Federation defense plans, and they fail, they still made the attempt, and may be deserving of a point or two of Renown (at the Narrator's discretion). This often makes a nice "consolation prize" for characters who tried and failed.

ASPECTS

Renown is always awarded to a particular aspect. Demonstrating one's loyalty to the Empire, for example, should earn a character Discipline Renown. Developing an innovative way to foil Federation sensors should give the character Skill Renown. When awarding Renown, Narrators should consider the character's actions carefully, decide which quality the action embodies, then award Renown Points to the appropriate Aspect. Refer to page 14 in the "Character Creation" chapter for a characteristically Romulan definition of Aggression, Discipline, and Skill.

Some actions will warrant a Renown award to multiple aspects. Circumventing a rebellion on a Romulan protectorate might earn a character Aggression Renown (if he used the threat of force), Discipline Renown (for making an example of the traitors), or Skill Renown (finding a unique resolution to the situation). The Narrator should consider awarding Renown to several aspects (e.g., 2 Aggression, 4 Skill).

Earning Renown in aspects frowned upon by Romulan society—Initiative and Openness—does not adversely affect a character, except at the Narrator's discretion. A high Openness does not affect a character's rank or Glory, but Admiral Alidok might react poorly to such a tolerant individual. Similarly, a character who demonstrates high Initiative might be viewed with suspicion.

PROMOTIONS

Narrators and players will note that promotions depend solely on a character's Renown. Experience Points and Skill levels are not required for advancement in society. The more a character acts "Romulan," following the path of *D'era*, the more likely his actions will attract the attention of superior officers and noted members of society. A subcommander who skillfully uncovers a Klingon invasion plan, displays valor in the resulting battle, and saves the life of a Romulan admiral might earn 8 Renown points—well on his way to a promotion to Commander.

Once a character earns sufficient Renown, he moves up the chain of command. Players should keep track of Renown awards in those aspects favored by Romulan society. Add the values in the favored aspects, subtracting any negative numbers, and consult the Rank Table on page 17 to find the character's new rank. While Renown is less important for characters such as merchants and scientists, they still gain the benefit of higher Glory (see below).

EXAMPLE: *Subcommander T'ret currently has 13 Aggression, 12 Discipline, and 8 Skill Renown, for a total of 33 (for the purposes of calculating his rank). He earns 3 Discipline Renown and 5 Skill Renown during the course of the evening's episode. T'ret's player adds these points to his current Renown, for a total of 41, and consults the Rank Table. T'ret deserves a promotion to Commander!*

Unfortunately, Subcommander N'tal has 0 Aggression, 10 Discipline, and 15 Skill. While her Renown is high enough for her to attain the rank of Subcommander, during an



episode she earns -3 Aggression. Her total Renown in Aggression, Discipline, and Skill equals 22 (-3+10+15). N'tal receives a demotion in rank.

Changes in rank do not necessarily come automatically, as soon as the character achieves the required Renown. They should instead serve the needs of the story, as determined by the Narrator. Just because a character accumulates enough Renown to become a centurion, for example, does not mean he takes the place of the current centurion. He might be reassigned to command a ship of his own, or continue to serve at a lower rank. Being passed over for promotion could even become the subject of a story arc, as the character looks into the reasons for the snub.

Narrators should keep close track of the number of Renown points they allot. Provide too few, and the characters advance slowly. Provide too many, and the characters advance too quickly. In general, Renown should only be given out for extraordinary activities that would attract the notice of others. If you find your characters moving up the chain of command too quickly, perhaps you should reduce the number of Renown points you award.

LOSING RENOWN

Just as a character earns Renown through his actions, he can lose Renown (or, more appropriately, earn negative Renown). Remember, Renown serves as a range, reflecting the character's reputation for particular attitudes. A character with positive Aggression Renown is well known for aggressively expanding the Romulan domain, for instance. A negative number represents a reputation for the opposite attitude—peacefulness for aggression, self-indulgence in place of discipline, or incompetence rather than competence.

D'ERA AND RENOWN

Some players may try to upstage the other characters for a few extra points of Renown, or they may do things that earn their character Renown at the expense of the group. To keep the group working together, Narrators can use *D'era* to keep disruptive players in line. While Romulan society praises individuals who excel, a character who puts his desires over the needs of the group, mission, or society as a whole is seen as self-aggrandizing. Romulans are expected to work together to achieve a common goal—the advancement of Romulan civilization.

Narrators can use Renown awards to discourage bad behavior. If, for example, a character vaporizes a Federation officer for no reason, he should not earn Renown, even though his action is certainly "aggressive." Such an act does not advance the Empire's objectives. In fact, he may lose Renown, for "showboating." A character who constantly upstages his crewmates, by seizing the moment and charging ahead with both disruptors blazing, may eventually begin to lose Discipline Renown. Finally, a character interested solely in advancing his own career may have to explain himself to his superiors, benefactors, and cohorts, or to the *Tal Shiar*.

GLORY COSTS

Asking an outsider (i.e., not a benefactor or cohort) for a casual favor (Favor Owed excluded) 5

Asking an outsider to intervene indirectly +1-5

Asking an outsider to intervene personally +5-10

Character is ...

... a friend -2

... a relative -1-5

... a soldier +1-5

... a *Tal Shiar* agent +3

... a senator +10

... the Proconsul +15

... Chairman of the *Tal Shiar* +15

... the Praetor +20

Benefactor

Asking a benefactor to provide casual assistance (e.g., information, equipment) 1-5

Asking a benefactor to intervene indirectly on your behalf 2-7

Asking a benefactor to intervene personally on your behalf 15

The Benefactor is worth ...

... 5 Development Points -5

... 3 Development Points -4

... 2 Development Points -3

Cohort

Asking a cohort to provide casual assistance (e.g., information, equipment) 1-3

Asking a cohort to intervene indirectly on your behalf 2-6

Asking a cohort to intervene personally on your behalf 12

The Cohort is worth ...

... 5 Development Points -4

... 3 Development Points -3

... 2 Development Points -2

Obtaining sensitive information 1-3

Obtaining classified information 4-6

Obtaining secret information 7+

• *Glory Point costs may never be reduced below 1.*

During play, a character may do something that deserves a negative Renown award, such as negotiating a settlement with the Federation or allowing a prisoner to escape. When this happens, a Narrator should give the character a negative Renown award. This is subtracted from the character's current total in a given aspect. At first, this reduces the character's reputation in a particular area. The character may have been known for his loyalty, but his undisciplined behavior begins to cancel that out. Eventually, if the character does not change his behavior, he will slip into negative values.

Romulan characters who fall below the required number of Renown points lose their positions in society immediately. When calculating Renown for the purposes of rank, treat any negative values as negative numbers. Thus, a character with Aggression 10, Discipline 5, and Skill -5 has a total of 10 Renown when determining rank.

Example: *Commander Suvath (Aggression 14, Discipline 16, Skill 10) is in over his head, having achieved his rank through political maneuvering and luck. During an episode, the dice do not go well for Suvath, and his player bungles some important Skill Tests. The Narrator gives Suvath -5 Skill Renown, making his totals Aggression 14, Discipline 16, and Skill 5, for a total of 35. Suvath is demoted to Subcommander, where perhaps he'll work off his reputation for incompetence.*

STORYTELLING

Renown can be used for more than simply measuring a character's fame. Narrators can use Renown as a storytelling tool.

Characters can gain and lose Renown for events beyond their control, as part of the Narrator's series. A benefactor might become disgraced as a traitor to the Empire, and thus affect his protégé. The Jol Tan Coalition might gain the upper hand in the Senate, attracting attention to its key members. Perhaps a relative performed some heroic service to the Empire, bringing honor to the entire family.

As with Renown awards, the Narrator should choose the appropriate aspect affected. The number of points involved depends on the severity of the event affecting the character. In this, as in other things, moderation is the key. If a benefactor suffers a political setback—an admiral losing a critical battle, for example—his player character protégé might lose one or two points of Aggression Renown. Because players don't like events beyond their control to affect their characters (especially adversely), affecting Renown in this way should be rare, and should be no more than a few points at a time. Similarly, these turns of events should be short-lived; it's not fair to penalize (or reward) a player for something beyond his control.

Affecting a character's Renown in this way provides the Narrator with an interesting way to involve the characters directly in events sweeping the Empire. Why has a character's benefactor suddenly lost favor in the Senate? Is it because his enemies embarked on a smear campaign? Why is the *Tal Shiar* suddenly investigating the character's family? Did someone accuse them of disloyalty? Each instance leads the player to wonder about the change in his character's Renown, and encourages him to investigate personally.

Some Advantages and Disadvantages provide Renown, which Narrators can use to enhance their stories further. Rather than giving a character Experience Points and Renown, Narrators could give a character a new benefactor, cohort, or accolade (like Order of the Terrik). This provides another way to tie Renown awards into the overarching story line. These types of awards should result naturally from events in the episode—the character saves the life of a senator, who takes an interest in

the character's career; the Praetor hears of the character's exploits and gives him a commendation; or the character offends an important dignitary, earning a sworn enemy. When using this option, the Narrator should provide the new trait in lieu of Experience Points and Renown awards. Similarly, a player can opt to spend Experience Points on one of these Advantages, with the Narrator's approval.

GLORY

Glory can be spent to affect the direction of an episode, by calling on outside help. A character sent to a planet to negotiate a treaty, for instance, might determine that a show of force is required; by expending Glory, he can summon another warbird to demonstrate the Empire's might. Glory also allows players to include their character's benefactors and cohorts in an episode. Is a benefactor available to help the character? Can he provide the information or assistance the character needs? Glory provides a way to answer these questions.

To use Glory Points in this way, the player should describe exactly what he's after. Does he want help from Proconsul Kota? What kind of help—information or intervention? How soon does he want it? This allows the Narrator to determine the cost, in Glory, of the plot change, using the Glory Costs table. The costs listed on the table are cumulative. Once the Narrator informs the player of the Glory cost, the player can elect whether or not to spend those points.

Narrators should refrain from using Glory for minor requests for aid—such as from a fellow supporting cast shipmate or a character that's already part of the story. Glory is intended to be used to call on larger forces, beyond the normal scope of the episode.

USING GLORY

The player spends the points of Glory at the time he makes his request. Players must be able to pay the total cost in full at this time. Players may not "owe" Glory points. If a character does not have enough points to spend to affect the story, then he doesn't have the political capital to spend, and the desired effect does not occur.

Once a player spends Glory Points, the desired effect must occur, though the ultimate outcome remains open to Narrator interpretation. The player characters may convince the Star Command to send a warbird to help them, but the commander may be less than happy about it, or be willing simply to put in an appearance. The Narrator ultimately controls the actions of supporting cast characters and decides the game's direction.

Of course, the Narrator is the final judge of when Glory can be spent. If allowing the group to summon a fleet of warbirds to assist them would ruin the episode, the Narrator is not obligated to cooperate. This does not mean the characters can't ask; the supporting cast character may be unavailable, or the request may be beyond the supporting cast character's ability to provide. If the Narrator vetoes the use of Glory Points, no points are spent.

Glory should never be used in place of a Skill Test. Influencing a senator's vote, convincing a *Tal Shiar* agent to drop his inquiry into a character's

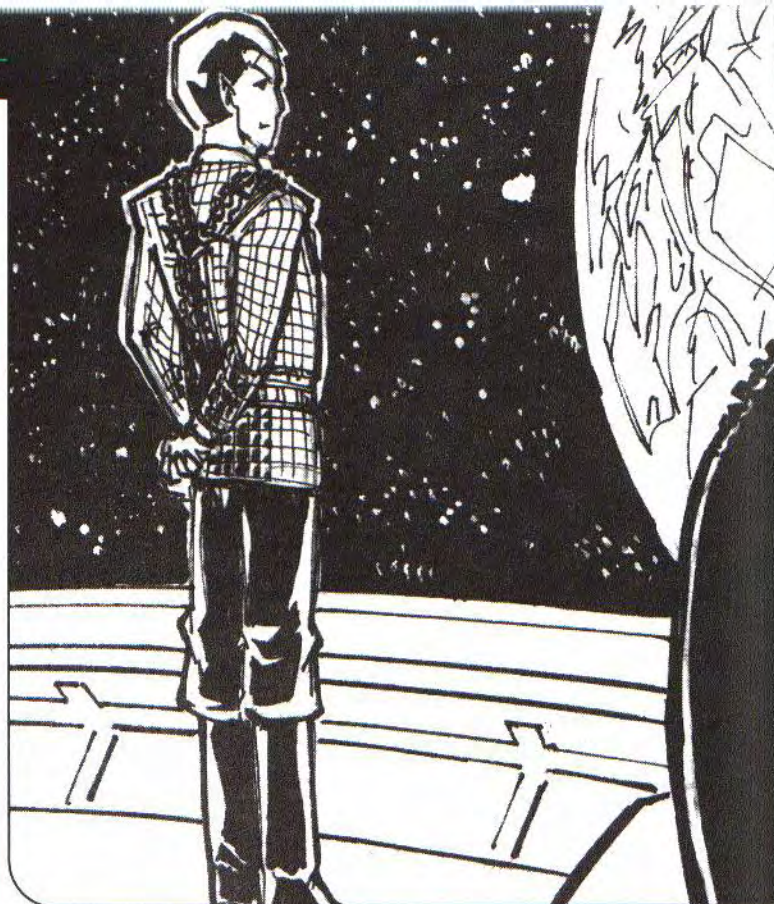

past, or persuading the Romulan Astrophysical Academy to provide the use of a new superweapon should require a Charm or Persuasion Skill Test.

CHANGING THE OUTCOME

Just as with Courage, players can spend Glory Points to increase a character's chance to succeed at actions during dramatic situations. If failure in a particular Skill Test would lead to disastrous results, or the player simply wants to be assured of success, the player can spend up to 4 Glory Points to improve the Test Result.

Each Glory Point spent increases the final Test Result by 1. As with Courage Points, the player does not have to decide to use Glory before he makes his roll. When used in this way, a player may not spend more than 4 Glory Points in a single round.

In addition, a player may not use Glory in this manner (to modify a Test Result) more than three times during a single episode. After all, Glory is intended to simulate the larger aspects of a character's role in Romulan society; it should not become a simple safety net, always there to save a character every time he gets into trouble.

REGAINING GLORY

Unlike Courage, Glory does not "refresh" at the end of the episode. Political capital, once spent, is gone (until the character earns more). Regaining Glory depends on Renown. When a character earns Renown in one of the three favored aspects, add a similar number to the character's Glory. The corollary is also true: If a character loses Renown, his Glory also decreases by an equal amount.

EXAMPLE: *Subcommander T'ret successfully uncovers a dissident cell at the Mirek shipyards, and the Narrator awards the char-*

acter 4 Skill Renown. T'ret's player also adds 4 points to T'ret's Glory.

Later on, T'ret fails to attack a Federation starship when he had superior advantage. He earns -2 Aggression Renown for his peaceful actions. T'ret also loses 2 points of Glory. Should his pacifism continue, T'ret will gain a reputation as a pacifist, and other Romulans will become less likely to aid him.

GLORY AWARDS

In addition to Experience Points and Renown, Narrators can reward characters with Glory Points. These characters have influence beyond their means. If a character conducts himself particularly well, then an award of Glory might be appropriate. Examples include leading an attack on an enemy ship when outnumbered and outgunned, following orders despite great personal risk (perhaps even death), or overcoming a disadvantage to accomplish some valorous feat.

Glory could be awarded at times when a Renown award would be inappropriate. A character's actions during an episode might not warrant Renown, but deserve some recognition (successfully mediating a dispute with a Federation captain might not deserve Renown, but might earn the character a few points of Glory, for instance). Finally, players may trade in Experience Points for Glory at a rate of 2 Glory per point of Experience.

Narrators should be wary of letting characters have too many Glory Points. Because players can spend these points to influence the course of an episode, their use could seriously compromise a particular story.



CHARACTER SHEET

NAME: _____
 RANK: _____
 SPECIES: _____

PLAYER: _____
 POSITION: _____
 CURRENT ASSIGNMENT: _____

ATTRIBUTES

| | |
|-------------------|------------------|
| FITNESS | PRESENCE |
| STRENGTH: _____ | WILLPOWER: _____ |
| VITALITY: _____ | EMPATHY: _____ |
| COORDINATION | PSI |
| DEXTERITY: _____ | RANGE: _____ |
| REACTION: _____ | FOCUS: _____ |
| INTELLECT | |
| LOGIC: _____ | |
| PERCEPTION: _____ | |

BACKGROUND HISTORY

| STAGE | DESCRIPTION OR ASSIGNMENT |
|----------------------|---------------------------|
| EARLY LIFE: _____ | |
| WAR COL. LIFE: _____ | |
| SERONA: _____ | |
| TOURS OF DUTY: _____ | |



SKILLS (SPECIALIZATION) LEVEL

| | | | | | | | | | |
|--|--|--|--|--|--|--|--|--|--|
| | | | | | | | | | |
| | | | | | | | | | |
| | | | | | | | | | |
| | | | | | | | | | |
| | | | | | | | | | |
| | | | | | | | | | |
| | | | | | | | | | |
| | | | | | | | | | |
| | | | | | | | | | |
| | | | | | | | | | |

ADVANTAGES

| | |
|--|--|
| | |
| | |
| | |

DISADVANTAGES

| | |
|--|--|
| | |
| | |
| | |

GLORY: _____
 RENOWN: _____
 AGGRESSION: _____
 DISCIPLINE: _____
 SKILL: _____
 INITIATIVE: _____
 OPENESS: _____

RESISTANCE: _____
 WOUND LEVELS

| | | | | | | | |
|-------------------|--------------------------|--------------------------|--------------------------|--------------------------|--------------------------|--------------------------|--------------------------|
| HEALTHY | <input type="checkbox"/> | <input type="checkbox"/> | <input type="checkbox"/> | <input type="checkbox"/> | <input type="checkbox"/> | <input type="checkbox"/> | <input type="checkbox"/> |
| STUNNED (+1) | <input type="checkbox"/> | <input type="checkbox"/> | <input type="checkbox"/> | <input type="checkbox"/> | <input type="checkbox"/> | <input type="checkbox"/> | <input type="checkbox"/> |
| INJURED (+1) | <input type="checkbox"/> | <input type="checkbox"/> | <input type="checkbox"/> | <input type="checkbox"/> | <input type="checkbox"/> | <input type="checkbox"/> | <input type="checkbox"/> |
| WOUNDED (+2) | <input type="checkbox"/> | <input type="checkbox"/> | <input type="checkbox"/> | <input type="checkbox"/> | <input type="checkbox"/> | <input type="checkbox"/> | <input type="checkbox"/> |
| INCAPACITATED (-) | <input type="checkbox"/> | <input type="checkbox"/> | <input type="checkbox"/> | <input type="checkbox"/> | <input type="checkbox"/> | <input type="checkbox"/> | <input type="checkbox"/> |
| NEAR DEATH (-) | <input type="checkbox"/> | <input type="checkbox"/> | <input type="checkbox"/> | <input type="checkbox"/> | <input type="checkbox"/> | <input type="checkbox"/> | <input type="checkbox"/> |
| KILLED | <input type="checkbox"/> | <input type="checkbox"/> | <input type="checkbox"/> | <input type="checkbox"/> | <input type="checkbox"/> | <input type="checkbox"/> | <input type="checkbox"/> |

NOTES



Ver'sa D'era!

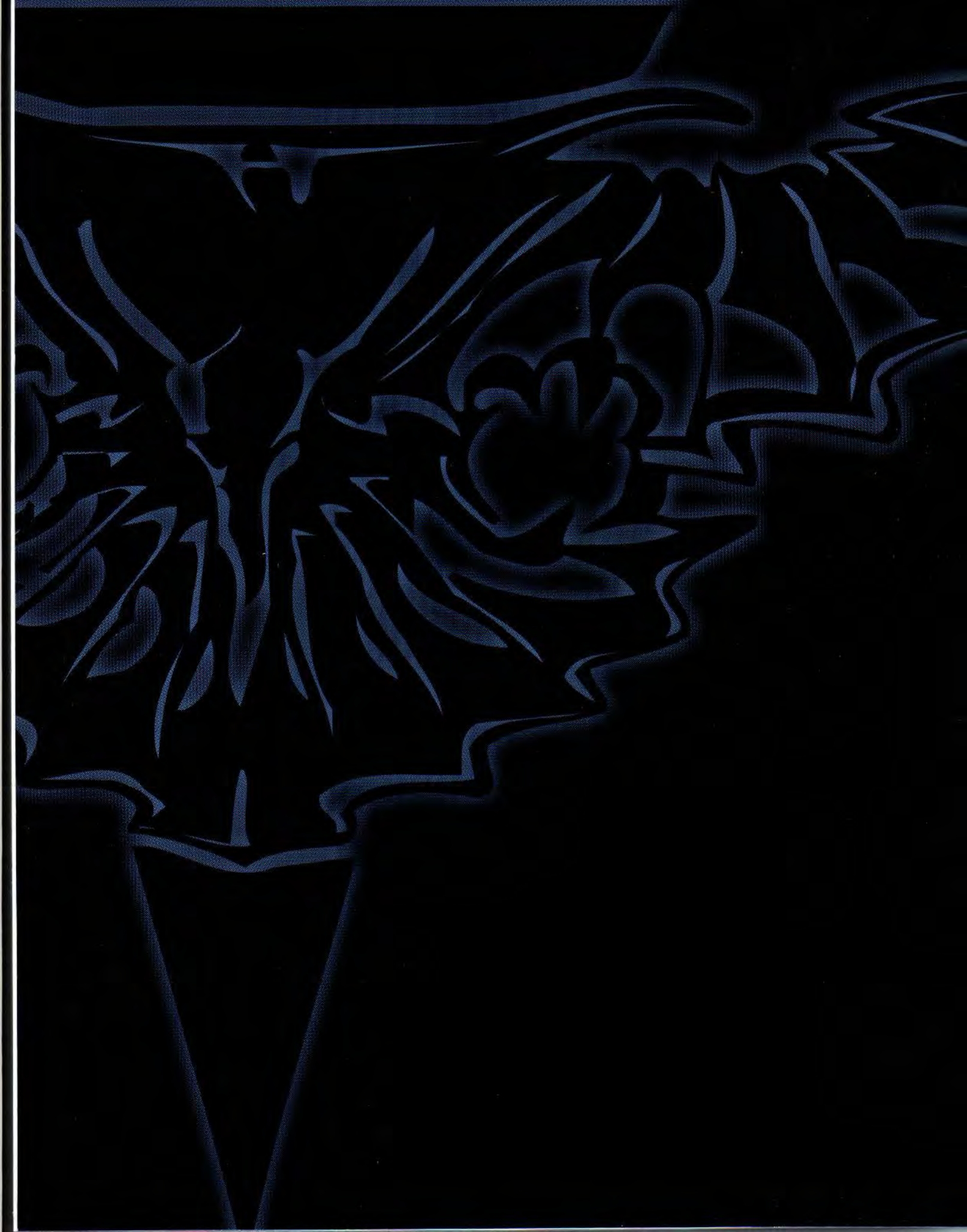

STAR TREK
THE NEXT GENERATION

*Romulan
Adventures*



BOOK 3

T H E W A Y O F D I E R A

Romulan Adventures

T H E R O M U L A N S T A R E M P I R E



B O O K . 3

AUTHORS: JAMES ESTES, ROSS A. ISAACS, EVAN JAMISON, STEVE KENSON, STEVE LONG, RICHARD MEYER, CHRISTIAN MOORE, PETER SCHWEIGHOFER

DEVELOPMENT: KENNETH HITE, ROSS ISAACS, CHRISTIAN MOORE

EDITING: JANICE SELLERS

STAR TREK: THE NEXT GENERATION® LINE DEVELOPER: ROSS A. ISAACS

GRAPHIC DESIGN: ANTHONY VAYOS

ART DIRECTION: RYAN MOORE, ANTHONY VAYOS

ORIGINAL ART: JOE CORRONEY, BARRY DOYLE, MARK FORRER, JOHN GRIGNI, PIA GUERRA, TERRY PALLOT, CRAIG SKAGGS

MAPS & CARTOGRAPHY: CHARLES RYAN, BARRY DOYLE

LAYOUT: ALVARO RIET

PRODUCT DEVELOPMENT, PARAMOUNT: PAUL RUDITIS

PROOFREADING AND FACT CHECKING: BILL MAXWELL

SPECIAL THANKS: TO MARK LENARD, FOR BEING THE FIRST. TO JOANNE LINVILLE, FOR EASILY BEING THE MOST MEMORABLE. TO ANDREAS KATSULAS, FOR REDEFINING THE ROLE. AND TO KENNETH HITE, FOR DESTROYING HIS SHIP RATHER THAN SURRENDERING.

DEDICATION: WE, THE PROUD HEIRS OF THE EMPIRE, DEDICATE THIS PRODUCT TO D.C. FONTANA AND PAUL SCHNEIDER. IN THE PRAETOR'S NAME.

DISCLAIMER: WHILE LAST UNICORN GAMES HAS RESEARCHED EXTENSIVELY TO MAKE THIS THE MOST AUTHENTIC STAR TREK: THE NEXT GENERATION ROLEPLAYING GAME POSSIBLE, THE DEPTH OF INFORMATION NECESSARY FOR A FULLY-REALIZED ROLEPLAYING GAME IS NOT ALWAYS REVEALED DURING A WEEKLY TELEVISION SHOW. WHILE WE HAVE TRIED TO EXTRAPOLATE LOGICALLY WITHIN THE FLAVOR OF ST: TNG, SOME LIBERTIES HAVE BEEN TAKEN AND PLAYERS SHOULD REMEMBER THAT ONLY THE EVENTS, CHARACTERS AND PLACES THAT APPEAR ON THE SHOW OR IN FILMS ARE CANON.

LAST UNICORN GAMES
9520 JEFFERSON BLVD., SUITE C
CULVER CITY, CA 90232
WWW.LASTUNICORNGAMES.COM

FIRST PRINTING — APRIL 1999
PRINTED IN CANADA



STAR TREK
THE NEXT GENERATION®
ROLEPLAYING GAME



A VIACOM COMPANY

Distributed to the book trade by Simon & Schuster, 1230 Avenue of the Americas, New York, NY 10020
STAR TREK™, ® & ©1999 Paramount Pictures. All Rights Reserved. STAR TREK and Related
Marks are Trademarks of Paramount Pictures. Last Unicorn Games, Inc. Authorized User.
©1999 Last Unicorn Games

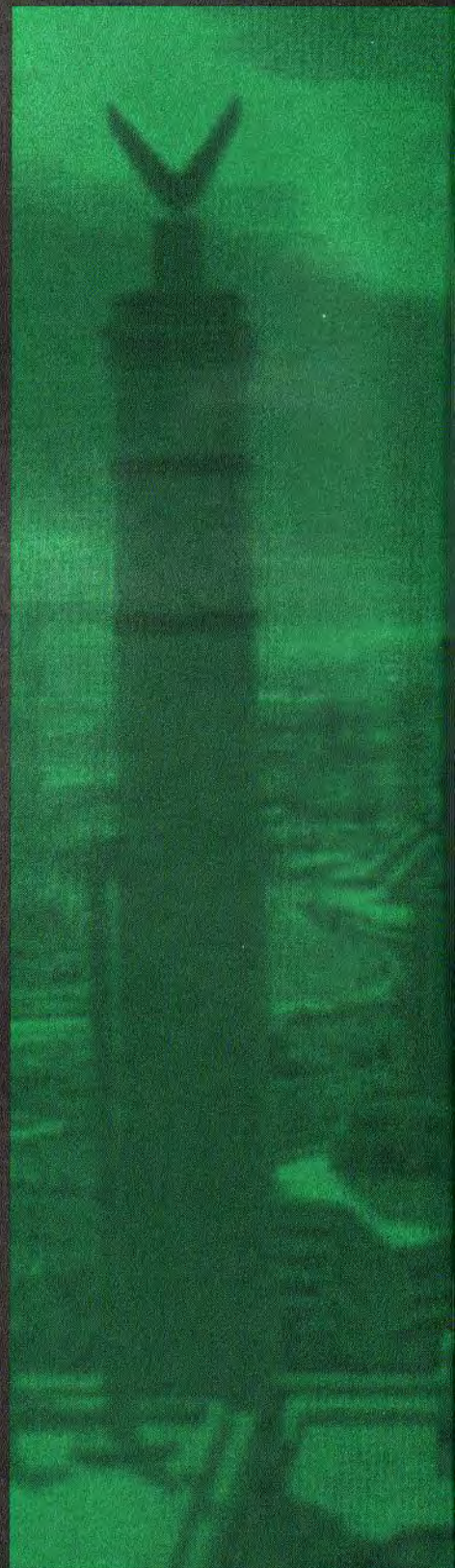

TABLE OF CONTENTS

THE GENTARA INCIDENT 5

DUTY OR CONSCIENCE 19



ADVENTURE...

WE DO NOT

SEEK ADVENTURE

— ONLY D'ERA.

THE GENTARA INCIDENT



This adventure is designed for an experienced Crew of Romulan players assigned to a *D'deridex*- or *D'valek*-class warbird. At least one of the Crew must be of officer rank, and it is extremely helpful if at least a couple of Crew members have purchased Department Head status, and attained a rank of at least Lieutenant or Subcommander.

Background

The planet Gentara is a Romulan fringe province, located in the Jezerek Sector, along the Romulan Neutral Zone. In many respects, it is an unremarkable planet, a watery world with modest mineral resources and little strategic importance. Yet Gentara is a client state of the Empire, whose native population and culture the Romulans have allowed to survive intact since its conquest a century ago.

The manner by which the Gentarans procured their freedom is not unlike the old Earth legend of Scheherazade. After the invading Romulan force had established superiority over their technologically inferior opponents, the Gentaran chieftain, the *shaddath* B'nir, beamed aboard the Romulan command vessel to plead for the lives of his subjects. The military commander, Centurion Tovath, gave B'nir one night to make a case for their survival—if he failed, he could watch their annihilation in the morning. The *shaddath* spoke passionately of the spiritual devotion of his people to their Goddess of the Deep, *Meshaad*, while marveling at the glory and the greatness of his conquerors. Amused and intrigued by the *shaddath's* oratory, Tovath spared the Gentarans for one more day, but announced he would destroy them the next day, if not further convinced of their worth. This 24-hour stay of execution continued for sixty days, and each day the *shaddath* learned more about the Romulans and their philosophy of *D'era*, and figured out how to cast his people to offer no real conflict with that manifest destiny.

Finally, on the sixtieth night, B'nir made his final appeal to Tovath. "You seek the universe, while the Gentarans wish only to become one with *Meshaad*. If we freely share all that we have with you, what harm will it bring you to let us live?" Thus was the Gentaran Pact born, a pact granting the Romulans broad powers to commandeer any and all of the planet's resources as needed, in exchange for Gentaran sovereignty.

Yet as control of the planet passed from Tovath to other governors, the Gentarans learned of the devil's bargain they had made. Romulan concerns brutally strip-mined vast areas of the ocean floor, leaving *Meshaad* to scream in mute agony to the Gentaran priests. Meanwhile, the Romulans conscripted tens of thousands of Gentarans to serve as front-line shock troops, using them in the conquest of a dozen other worlds. Thus it has come to pass that the current *shaddath* of Gentara seeks to find a way to break the Gentaran Pact, and to remove the shackles of Romulan control.



Instead, the Gentarans have become embroiled in a power struggle between rival Romulan political factions. One faction, the Suketh, believes that the Empire has already been stretched thin by war, and needs time to absorb the worlds it has already conquered. They secretly arranged for the Gentarans to receive help from a mercenary clan of Nausicaans, who plan to commit various acts of terrorism in hopes of triggering an incident designed to show that the Empire's reach exceeds its grasp.

News of this plan, however, has reached the ears of Kassus, the ambitious senator last seen in *A Fragile Peace*. Kassus hopes to use these events to forward his own aspirations to become Praetor, by exposing the plot and revealing the identity of a major Suketh sympathizer, Ambassador Sorgun, in the process. Kassus brings the player characters into this conflict, asking them to investigate the situation on his behalf. They must uncover and survive the machinations of both sides to resolve the conflict successfully while preserving their own reputations.

SYNOPSIS

The adventure begins on Romulus, outside the capital city of Val'danadex Trel, as the player characters receive an unexpected invitation to attend a state dinner from Senator Kassus. After they dine, Senator Kassus calls them aside and announces that their ship is being sent to the planet Gentara, a client state of the Empire recently plagued by

unrest. Their official mission is to ferry a Romulan ambassador there and show the flag of the fleet while the ambassador negotiates a suitable peace offering of tribute from the Gentarans. Kassus requests that the Crew work behind the scenes while the negotiations take place, however, to find out whether outside influences are inciting the Gentarans.

At Station Avril Nine, the Crew's ship picks up Ambassador Sorgun and a second surprise passenger, a *Tal Shiar* agent who immediately rubs some members of the Crew the wrong way. On the way to Gentara, curious events aboard ship may cause the Crew to suspect whether one of the passengers is in league with the rebels.

Once in orbit around Gentara, some Crew members beam down with the ambassador to provide security and assistance for the negotiations, while others remain on board and employ the ship's sensors to search for signs of a missing Romulan freighter in the Genteran system. Both groups soon have more on their hands than they bargained for.

Sorgun's hard-line negotiating tactics cause the Genteran chieftain, the *shaddath*, to invoke the local custom of trial by combat to resolve the dispute, and one of the Crew members is named as the Empire's "champion." Meanwhile, the warbird's scans lead it to Gentara's moon, where they find the wreckage of the freighter and signs of an ancient "bird of prey," an ancient starship design primarily used today by the Nausicaans.

At this juncture, a number of other forces may appear on the scene. The *shaddath's* Nausicaan allies may show themselves, and attack either the negotiating team, the shuttle patrol, or both. Based upon which side has the upper hand, Ambassador Sorgun may commit his own ace in the hole—a warbird with a crew loyal to the Suketh—to the fray. Finally, the *Tal Shiar* agent Kaya attempts to commandeer the Crew's ship and call in her own reinforcements.

The final resolution of the conflict may involve both hand-to-hand and ship-to-ship combat. As the natives fight desperately for their freedom, the various Romulan factions face off against each other, vying to see which group can blame the others for fomenting the rebellion and take credit for defeating it. Throughout it all, the Crew must attempt to quell the rebellion, preserve their reputations, and stay alive.

ACT ONE

SCENE ONE: AFFAIRS OF STATE

As the episode begins, the Crew's warbird is docked for several days of routine maintenance at the Mirek spaceport orbiting Romulus. The Crew enjoys a much-deserved shore leave on the homeworld. For utility's sake, they should all stay at the same hotel—a small military hostel—although individuals may instead visit home. One morning,

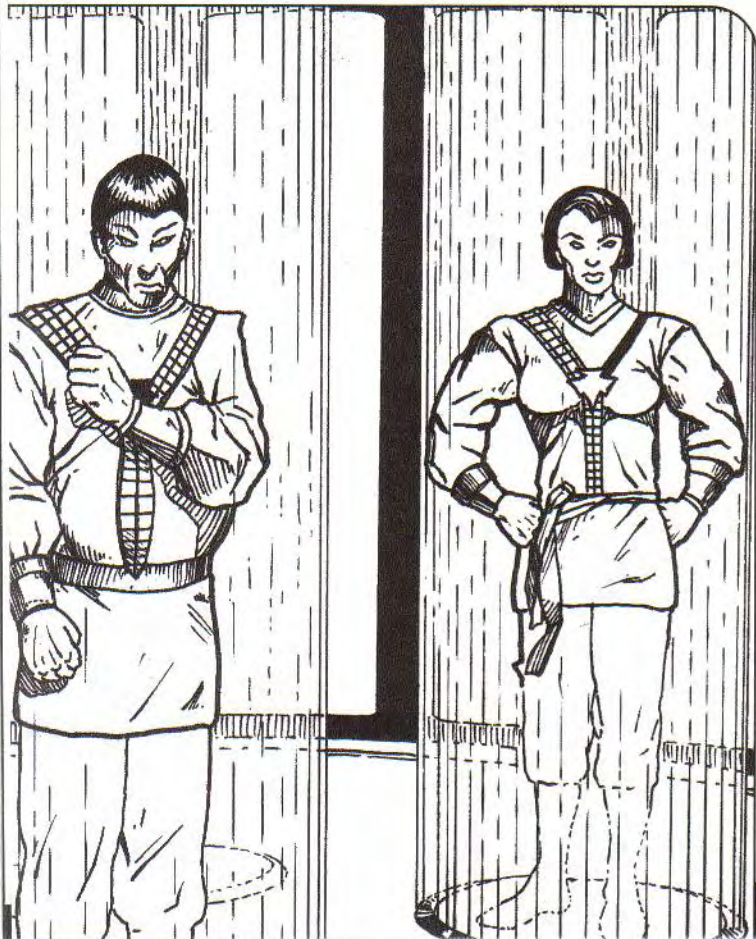



as the player characters (PC's) prepare for a day's sightseeing, a messenger arrives with an invitation for an evening at the estate of Senator Kassus, for a dinner honoring the promotion of three commanders to the rank of Centurion.

The invitation names each officer, so those traveling on their own should be informed (PC's traveling out of town can beam in for the party). If asked about the reason for the invitation, the messenger, an aide to Senator Kassus, merely shrugs and suggests that the senator likes to cultivate connections with up-and-coming young soldiers. One thing is clear: One does not turn down an invitation from a prominent senator.

Before the dinner, the Crew might use any local contacts they possess to try to find out more about Senator Kassus (consult an appropriate contact, ally, or patron, or make a Challenging Test against Logic to identify Senator Kassus as their patron). See Senator Kassus' entry in *Romulan Characters*, in the "Scions of the Empire" chapter, for more information.

As dusk falls, the invitees receive the coordinates to beam down to a security checkpoint, where impassive members of the senator's security detail carefully frisk all guests. The guards direct the Crew across the well-manicured grounds of the senator's estate to an enormous covered pavilion filled with long wooden tables and almost a thousand other guests. Give the Crew time to mingle with the other guests—the cream of Romulan society. When dinner is served, the Crew finds themselves seated separately about the room. Describe the flatware adorned with the crest of the house of Kassus, the sparkling crystal goblets, and the succulence of the meal they are served (which includes a rich, thick soup, several meat courses, and a flaming dessert).

The Crew should be suitably awed by what they see, for only those of noble birth or with two or more levels of skill in Diplomacy have probably encountered such grandeur before. Give each character the opportunity to roleplay his dinner conversations with fellow guests. The emphasis should be on "role" rather than "roll" playing, though Narrators should give characters with Diplomacy, Persuasion, or Charm skills the benefit of the doubt if they commit a minor faux pas. Remember, many of the other invitees are people of great influence on Romulus and in the Empire; thus, PC's can come out of the evening with new friends or important new enemies—and the Narrator can plant leads and contacts for future adventures here, as well.

After dinner, a troupe of acrobats begins to perform. During the act, an officious-looking aide gathers the Crew together and directs them to a nearby sculpture garden out of earshot from the pavilion. There, seated beneath a statue of Tellus, Senator Kassus awaits. He thanks them for coming, and announces that he invited them to ask for their help. He tells them their ship has been ordered to depart tomorrow for station Avril Nine, to pick up Ambassador Sorgun of the Diplomatic Corps. From there they are to proceed to the planet Gentara, one of the Empire's client states, which thus far has been allowed to maintain its own internal government.

Of late, a number of terrorist incidents have occurred against Romulan personnel on-planet, culminating last week in a bomb explosion at the Trade Ministry which killed seven Romulans, including the Deputy Administrator. Ample circumstantial evidence exists to indicate the Gentaran government supports these terrorists, though no concrete proof. The Crew's official mis-

WHAT KASSUS WANTS

Based upon his information, Kassus believes the Suketh faction is involved in fostering the crisis on Gentara. He wants to foil them and expose their involvement to enhance his own standing in the Senate. He hopes the player characters can accomplish this task on their own, but he takes no chances and adds another of his supporters, the *Tal Shiar* agent Kaya, to the mix. As long as he comes out looking like a hero, Kassus does not really care who gets the job done.

sion is to deliver the ambassador to Gentara, show the flag of the Empire, and assist the ambassador in his negotiations for a peace offering to affirm Gentara's continuing commitment to the Empire.

Here Kassus motions the Crew closer, and speaks to them in his most conspiratorial tone. His own personal intelligence network, he says, suggests the situation may be much more serious. One month ago, a Romulan freighter carrying a cargo of ship-mounted disruptors disappeared without a trace near Gentaran space. Kassus suspects the two events are related, and that Gentara prepares to mount an armed insurrection to throw off Romulan rule.

He wants the Crew to search for any trace of the missing freighter and its cargo, using their mission as a cover. He also notes that Gentaran spacecraft, equipped with outdated technology, lack the strength to down a freighter. Kassus therefore believes the Gentarans receive assistance from an outside force, the Klingons perhaps, or the UFP. In return for their attention to this matter, Kassus pledges his personal gratitude.

SCENE TWO: STRANGE PASSENGERS AND UNEXPLAINED EVENTS

The journey to Station Avril Nine takes two days at warp factor 8, and the journey is uneventful, save for a report from Engineering that maintenance on the long-range sensors remains unfinished, and they appear improperly calibrated. If a player character works in Engineering, he can run a full diagnostic on the sensor arrays and complete the necessary repairs. Treat this situation as an Extended Skill Test using either the Engineering (Sensor Systems) specialty or the System Engineering skill. Full calibration of the system requires five successful Challenging rolls, with Dramatic Successes counting as two successes, and one roll allowed each hour. Regular failures cost the process nothing but time, but a Dramatic Failure throws the process completely off schedule, and returns the work to square one (zero successes). If none of the Crew is an Engineer, assume the problem takes twelve hours to repair; if two or more PC's have Engineering assignments, use the rules for Combined Skill Tests to resolve the problem.

Arriving at Station Avril Nine, a space station orbiting the outer planet of a nearby star system,

AMBASSADOR SORGUN**Attributes**

Fitness 2

Strength +1

Coordination 2

Intellect 4

Logic +1

Perception +1

Presence 4

Psi 0

Skills

Administration (Diplomatic) 3 (4); Charm (Influence) 2 (3); Command (Diplomatic) 2 (4); Computer (Research) 2 (3); Culture (Romulan) 2 (3); Diplomacy (Romulan Client States) 2 (3); Dodge 2; History (Romulan) 3 (4); Language: Gentaran 2, Romulan 4; Law (Interstellar Law) 3 (4), (Romulan) (5); Personal Equipment (PADD) 2 (3), (Comlink) (4); Persuasion (Oratory) 4 (5); Search 1; Social Science (Political Science) 4 (5); Vehicle Operations (Shuttlecraft) 1 (2); World Knowledge (Romulus) 3 (4), (Gentara) (4)

station personnel acknowledge the Crew's hailing message and brusquely notify them that two people are ready to beam aboard. Have the warbird commander order the highest-ranking Crew member(s) to report to the transporter room to welcome the passengers. The new arrivals materialize in the transporter chamber. One, a ruddy-faced man with a graying crown of hair and a middle-aged paunch, cordially introduces himself as Ambassador Sorgun, and gives the warrior's salute to each Crew member present (though it appears it's been some time since he's seen military service). The second passenger is a physically fit young woman with short-cropped hair and high cheekbones, a feline grace, and a haughty mien. Although she does not identify herself until requested to by a senior officer, Lieutenant Kaya's distinctive uniform marks her as a member of the *Tal Shiar*.

If any player characters have the disadvantages Sworn Enemy or Vengeful in regard to the *Tal*

WHAT SORGUN WANTS

The Suketh Coalition wants its operative, Ambassador Sorgun, to place the negotiations in a position where the Romulans will fail, while making it look like someone else is responsible for the failure. Sorgun plans to use the Crew as the fall guys, if possible. He is suspicious of Kaya's presence, and tries to make the Crew suspicious of her intentions as well. By nature, Sorgun is extremely cautious, and while he plays his part in forcing the crisis to the point of challenge combat, he will hesitate to commit his own reserve forces to the side of the Gentarans unless their victory is certain.

LIEUTENANT KAYA

Attributes

Fitness 3

Strength +1

Coordination 4

Intellect 3

Perception +1

Presence 2

Empathy -2

Willpower +1

Psi 0

Skills

Athletics (Jump) 3 (4); Computer (Data Alteration) 3 (4); Culture (Romulan) 2 (3); Dodge 4; Energy Weapon (Disruptor) 3 (5); Espionage (Counterintelligence) 2 (3); History (Romulan) 1 (2); Intimidation (Torture) 3 (4); Language: Genteran 2, Nausicaan 2, Romulan 3; Law (Romulan) 1 (2); Personal Equipment (Comlink) 2 (4); Search 3; Security (Law Enforcement) 2 (3); Shipboard Systems (Tactical) 2 (3), (Communications) (3); Social Science (Political Science) 2 (3); Starship Tactics (Planetary Support) 3 (4); Systems Engineering (Communications) 2 (4), (Computer) (4); Unarmed Combat (Kormerek) 3 (5), (Romulan Navy Martial Arts) (4); Vehicle Operations (Shuttlecraft) 2 (3); World Knowledge (Romulus) 2 (4), (Gentara) (3)

Advantages

Security Clearance +3; *Tal Shiar* Rank 3

Shiar, Kaya's presence on board reopens old wounds, reminding them how this hatred developed. Note: If no PC Crew members have these disadvantages, give an important supporting cast crewman (the first officer, the legate, or even the captain) a -2 Sworn Enemy disadvantage—the *Tal Shiar* took away an uncle in a midnight raid—to create the appropriate amount of dramatic tension on board.

Throughout the episode, Lieutenant Kaya is arrogant, impossible to please (for example, when shown to her quarters, she immediately demands accommodations at the opposite end of the crew section, even if someone else must be moved), and completely close-mouthed about her reason for being on board (instead giving typical *Tal Shiar* answers like "you're not cleared for that information"). No matter where the PC's turn, Kaya eventually shows up, giving the Crew the uneasy feeling that she's snooping all around the ship. Any encounter with Kaya teeters on the edge of violence. Crewmen with no prior bias toward the *Tal Shiar* might develop one after a day or two in close proximity to Kaya.

Sorgun, too, is extraordinarily interested in learning about the PC's ship and its capabilities, but he couches his inquiries diplomatically, so they seem like friendly curiosity. During the trip to



Gentara, he makes a point of having a private conversation with each PC, soliciting each one's input about the mission and attempting to build a bond of friendship between the two of them.

Let the Crew's reactions to these characters be dictated through roleplaying (both the Narrator's portrayal of Sorgun and Kaya and the player's reactions), rather than making die rolls to see whether they are Intimidated, Charmed, or Persuaded. The Narrator should be aware of the vibe he creates when portraying the Supporting Cast; it largely depends on his portrayal whether the players like Sorgun or dislike Kaya.

While the ship makes the week-long trip to Gentara (at warp 8), three events occur that may attract the Crew's notice and heighten their concern:

Sometime on the first day, the Communications station detects, with a Moderate Shipboard Systems (Communications) Test, an outgoing sub-space transmission being sent from somewhere on ship (actually being sent by Kaya, to her trio of small assault craft lying cloaked off Gentara). A second Moderate Test pinpoints the source of the transmission to the crew quarters area. A sweep of

WHAT KAYA WANTS

Kassus has provided Lieutenant Kaya with essentially the same information as the Crew, and told her to hold her resources in reserve in the event that the PC's (whom she knows are also working for Kassus) get into trouble. She is certain the Crew will fail, however, and operates throughout the mission on the assumption that the *Tal Shiar* will have to save the day.

GENTARA II

Class: M

System Data: A single, uninhabited moon, Mito

Gravity: 1.05 G

Atmosphere: Oxygen-nitrogen, with a very thick ozone layer that holds down surface temperatures and leaves the sky in a permanent state of haziness

Hydrosphere: 80%

Climate: Cool and extremely wet

Sapient Species: Gentarans evolved from amphibian life forms. They are 1.5 to 2 meters in height, with a stooped posture and short arms. Their skin is mottled and cool to the touch, and their eyes are reptilian in shape and yellow-brown in color. Although no longer amphibian, Gentarans maintain vestigial webbing between their fingers and toes, and remain excellent swimmers.

Tech Level: Mostly Level Five, including ion-drive spacecraft, but developments in some fields like electronics have lagged due to the humid environment, which induces corrosion. Plastics and other organic materials are substituted for metals in many technologies for the same reason.

Government: Hereditary monarchy, whose ruler is known as the *shaddath*.

Culture: Gentarans believe all events follow the plan of *Meshaad*, Goddess of the Deep. The Gentarans thus believe the Romulan conquest of their planet was part of this plan, to make Gentara aware of the greater universe, but that the Romulan presence must inevitably end "as *Meshaad* wills."

the area by a Security team uncovers—on a Challenging Search test, –1 for each additional five minutes spent searching—a relay used to redirect transmissions emanating from another source aboard ship. This lead dead-ends here for the moment, though Crewmen can deduce that the technique used would require a fairly sophisticated Communications skill. A Crewman making a Difficult Test vs. Systems Engineering (Communications), Shipboard Systems (Communications), or even Personal Equipment (Communicator) can construct a tap on this relay, which would enable any future transmission over it to be traced to its source. If successful, this increases the Crew's ability to react quickly to events during Acts Two and Three. Kaya does not send any additional transmissions until then.

Beginning midway through the third day, Medical personnel or any Crewman visiting sickbay can make a Moderate Intellect Attribute roll (including any Perception Edges) to notice someone has jimmied open one of the supply cabinets (Sorgun, shortly after midday). An inventory of the cabinet reveals that a spray-hypo and a quantity of a fast-acting sedative have been stolen. A search of the ship fails to turn up the missing equipment (though Narrators can ask the Crew to make several Difficult (13) Search Skill Tests during the trip); Sorgun hides the spray-hypo on his person, believing that none would dare search an ambassador.

On the evening of the fifth day, Comm station personnel making a Routine Shipboard Systems (Communications) Test detect an incoming transmission bypassing normal channels (and being sent by the Gentarans to Sorgun). Again, a Security team dispatched to the identified shipboard destination finds no one there, but a Moderate Search test reveals another hidden relay, which works similarly to the device in Event 1, but has a less sophisticated design and is not as well hidden. Again, though tracing the message back to its recipient is impossible, the relay may be tapped (via a Challenging Test of relevant skills) to trace future transmissions.

Based upon these events, members of the Crew may decide to put one or both of the passengers under surveillance. To determine the success of such a tail, make an Opposed Test using the player character's Stealth against the Search roll of the NPC being followed. Roleplay the results of the tail, based on the degree of success achieved. Note that Kaya attacks any shadow she discovers, fighting until restrained by a third party. If such a tail is set on the right person before these events transpire, someone may even be caught in the act.

Finally, player characters may attempt to do computer research about the Gentarans or their two passengers. On a Moderate Computer Test, the Crew can learn any basic background data they wish to know about Gentara and its customs (see accompanying sidebar). With a Dramatic Success, the PC's learn about the Gentarans' custom of resolving disputes by ritual combat (known as the Call to Challenge), and that the person challenged can invoke the right to select the form of combat—death, submission, first blood—and the weapons to be used.

Personnel records on Sorgun summarize his background (born and raised on one of the Frontier colony worlds) and distinguished service record. All personal data on agent Kaya is classified, and can only be obtained by hacking into the *Tal Shiar* files, requiring a Difficult Computer (Data Alteration/Hacking) Test.

If successful, the Crew learns two useful nuggets of information: First, agent Kaya suppressed two prior planetary rebellions, by calling in a special assault force; and second, Senator Kassus arranged her commission in the *Tal Shiar*. If unsuccessful, the computer alerts Kaya to the attempt to hack into secure files. Depending on the level of the failure, the Crew might hand Kaya a powerful weapon to use against them: evidence of treason. (Similarly, the computer might simply log the successful intrusion, filing the details away for later use by the *Tal Shiar*.)

ACT TWO

Narrator's Note: On- and off-world scenes throughout this Act occur in tandem, so it is necessary to jump-cut between them as time passes. Sorgun and his Gentaran allies largely control the timeframe for events on the planet; the timeframe for off-world events, however, depends on the speed with which the Crew finds the downed freighter. This can greatly impact the course of events for the rest of the scenario. It is vital, therefore, for the Narrator to keep accurate track of time throughout this Act.

Seven days later, the Crew's ship assumes a standard orbit around Gentara II. See the Gentara II template for more information.

SCENE ONE: A TENSE ARRIVAL

The ship's commander allows Sorgun to make the arrangements for beaming down to the planet's surface, while he assembles the PC's and Supporting Cast in private to discuss which Crew members travel with Sorgun, and who stays on board to search for signs of the missing freighter. Let the players decide which assignment appeals to them, within reason (i.e., make sure that at least one character with skills in sensor operations, weapon systems, and Engineering stays behind). To the away team's surprise, Kaya does not accompany them to the planet.

Using the coordinates obtained by Sorgun, the negotiating team materializes on a small island, outside of the *shaddath's* estate, a sprawling complex of one- and two-story buildings of pinkish sandstone, accompanied by a twelve-man Romulan security force (see *Gentaran Estate* map). Though the temperature is mild, the air is thick with humidity, and off to the west a wispy fog shrouds the water's edge.

The terms of the Romulan occupation forbid Gentarans from carrying energy weapons. A number of native guardsmen wait in the courtyard, carrying pole weapons with sickle-like blades on each end, and eyeing the Romulan security contingent (whom they outnumber two to one) warily. Tension hangs thickly in the air, almost as thick as the stifling haze.

The front door of the estate opens, and a Gentaran in priestly robes emerges. He exchanges formal, but frosty, greetings with Sorgun and the PC's, and conducts them inside, where the negotiations will take place. The Crewmen present may either elect to sit in on the negotiations, or wait outside to add their strength to the security force. If one or more PC's go inside, their actions are resolved in Scene Two. If one or more PC's remain outside, their actions are resolved in Scene Three.

SCENE TWO: WHAT PRICE TRIBUTE?

The negotiating team moves through the halls of the grand estate, passing a number of spacious

but sparsely furnished rooms, before entering what appears to be a large formal dining chamber. A long, low table, surrounded not by chairs but by large, plush cushions, dominates the room. The negotiators must arrange themselves cross-legged on the floor, then wait for several more minutes.

Finally, the priest rings a large bell, and the *shaddath*, accompanied by scribes with PADD's, various ceremonial functionaries, and a pair of hulking personal bodyguards, enters the room through a side door. His yellow-brown eyes unblinkingly appraise each member of the negotiating team, lingering last and longest on Ambassador Sorgun. As he sits, a functionary rises and proclaims, "You have come to bear suit against the *shaddath* of Gentara. State your case, and receive his justice."

During the negotiations, if the player characters contribute to the discussion, immediately make a Renown Test using the highest of the character's aspects in Initiative, Openness, or Skill Renown against a Difficulty number of 10, to determine if he commands enough respect from the *shaddath* to be listened to. If not, the *shaddath* ignores the character's comments outright, and the discussion continues; if a second outburst occurs, the Gentarans attempt to remove the meddler from the room. If the Renown Test succeeds, the *shaddath* thereafter treats the character as a full member of the negotiating team; Ambassador Sorgun glares witheringly at the Crewman for his intrusion.

As the talks proceed, Sorgun's tone appears far from accommodating, as he lays the blame for the past terrorist acts at the *shaddath's* door. He hardly appears diplomatic as he denounces Gentaran perfidy, and snarls that a painful price must be exacted. The *shaddath* initially denies the ambassador's allegations, responding with a pained but patient tone that becomes more exasperated with each passing minute.

It soon becomes clear that Sorgun seeks a hostage as his tribute—the first-born daughter of the *shaddath*, who by tradition will at her maturity become the High Priestess of Meshaad. Anyone who performed background research on Gentara knows that such an arrangement would not only be completely unacceptable to the Gentarans, but deeply offensive, as well.

If anyone has this knowledge, and has also been recognized as a member of the negotiating team, he has one chance to divert the talks to a calmer course (perhaps by suggesting a different tribute), by making a Difficult Oratory roll. Unless this succeeds, two hours after the negotiations begin, the inevitable happens—the *shaddath* rejects Sorgun's demand and issues the Call to Challenge.

Sorgun accepts the challenge, and names the Crewman with the highest combination of Vitality and Dexterity accompanying him as the Empire's champion.

GENTARAN ESTATE

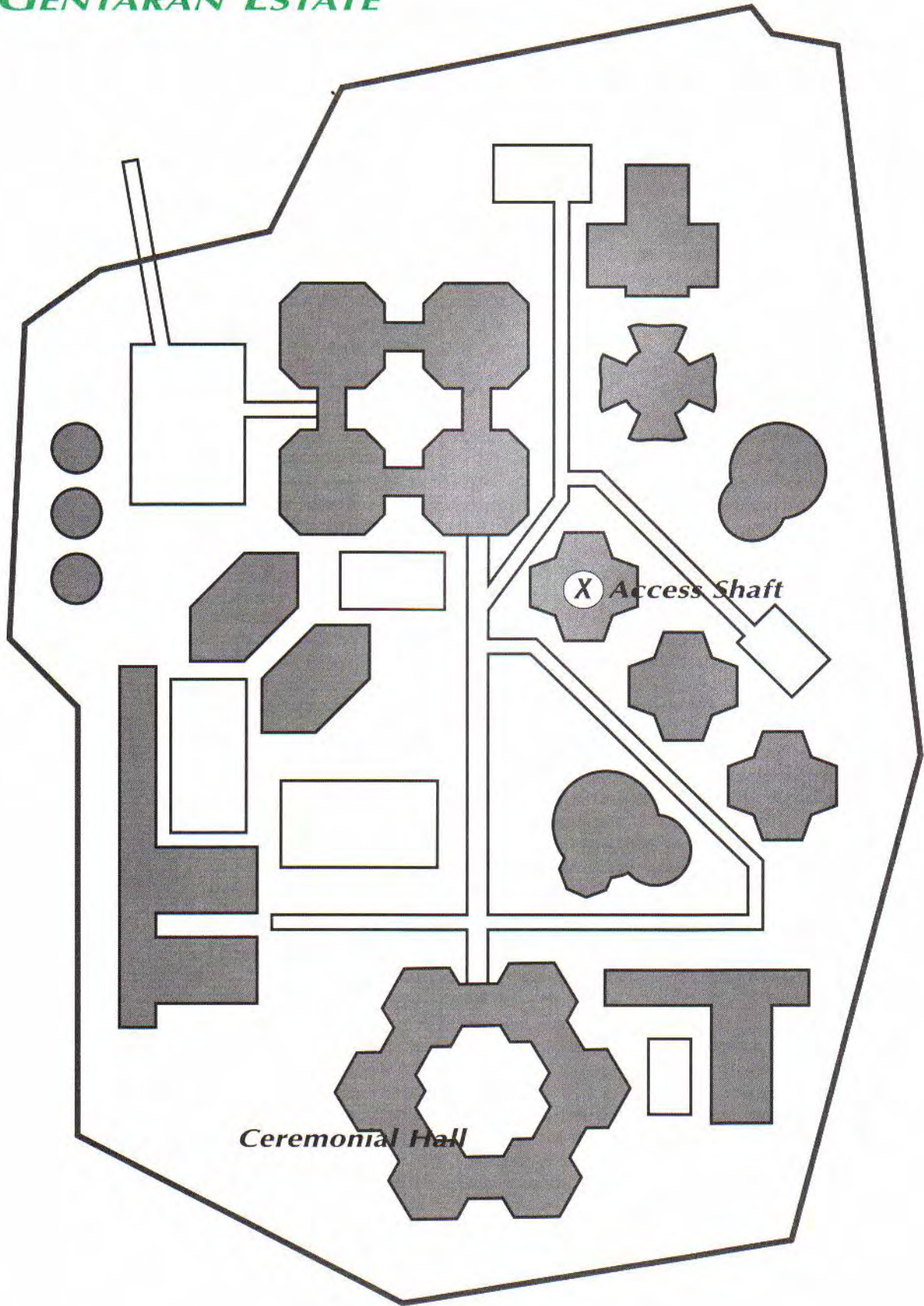

UNDERGROUND STORAGE CAVERNS

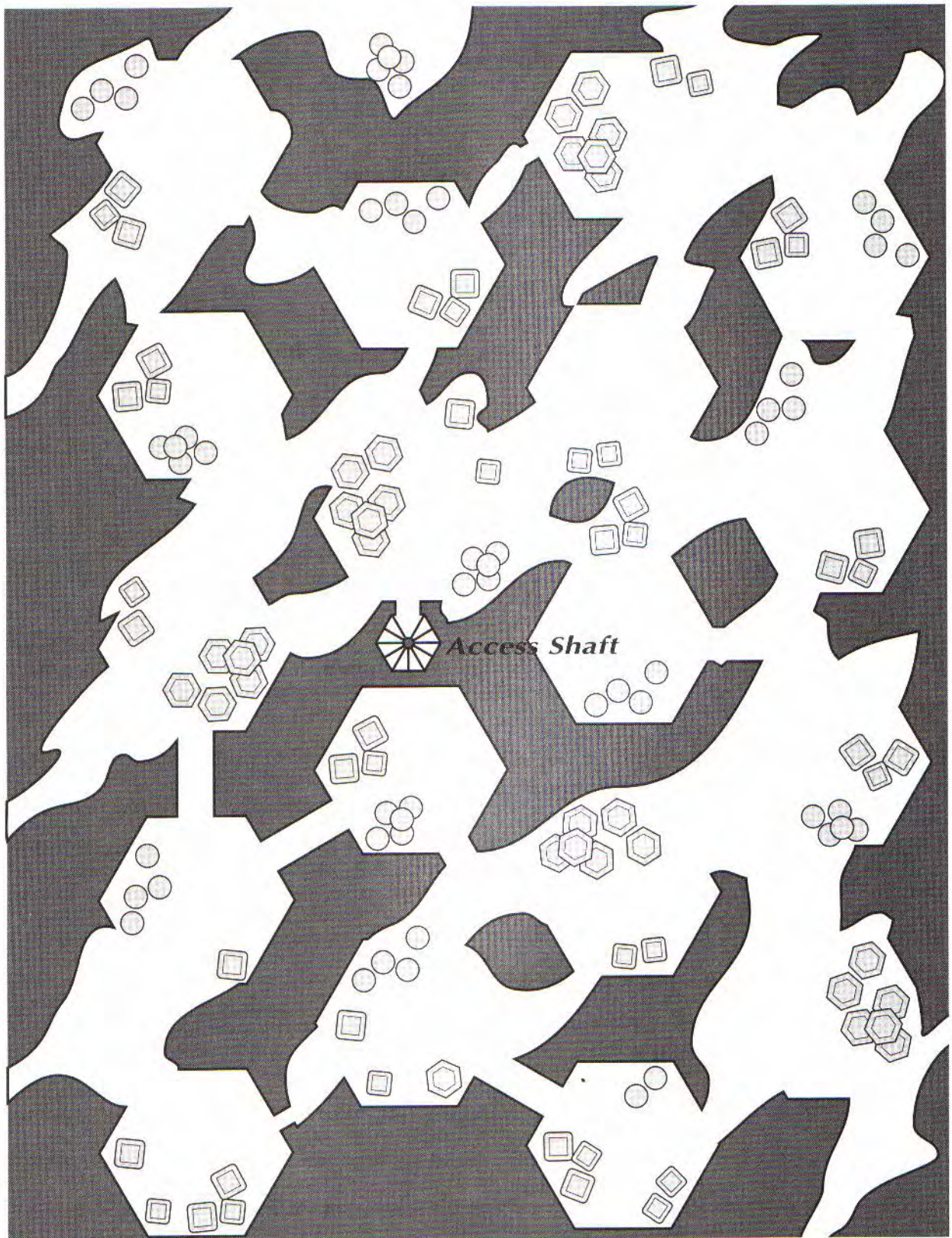

NAUSICAAN MERCENARY**Attributes**

Coordination 2
 Reaction +1
 Fitness 3
 Strength +2
 Vitality +1
 Intellect 1
 Presence 2
 Psi 0

Skills

Athletics (Lifting) 1 (2)
 Energy Weapon (Disruptor) 1 (2)
 Intimidation (Frighten) 2 (3)
 Personal Equipment (Tricorder) 1 (2)
 Planetside Survival (Urban) 1 (2)
 Unarmed Combat (Brawling) 2 (3)

SCANNING THE MOON**Change Orbit**

Time to achieve moon orbit: 10 minutes
Roll required to pinpoint landing site (roll every 10 mins): Moderate (6)
Perception roll required from Kaya (roll every 20 mins): Automatic
Sensor roll required for detection of Nausicaans (roll every 30 mins): Moderate (6)

Send Shuttle

Time to achieve moon orbit: 30 minutes
Roll required to pinpoint landing site (roll every 10 mins): Challenging (9)
Perception roll required from Kaya (roll every 20 mins): Moderate (7)
Sensor roll required for detection of Nausicaans (roll every 30 mins): Challenging (9)

Send Probe/Shuttle

Time to achieve moon orbit: 1 hour
Roll required to pinpoint landing site (roll every 10 mins): Routine (4)
Perception roll required from Kaya (roll every 20 mins): Challenging (8)
Sensor roll required for detection of Nausicaans (roll every 30 mins): Challenging (11)

SCENE THREE: THEY ALSO SERVE WHO ONLY STAND AND WAIT

Meanwhile, Crewmen waiting outside with the security detail are free to roam the estate grounds. The other Romulans remain alert, swap war stories, and show little concern for the guardsmen eyeing them menacingly from a distance. Although the mood remains tense, both sides appear to be waiting for the results of the negotiations before deciding what to do next.

During the two-hour negotiations, once every thirty minutes of game time, the Narrator should inquire as to the Crew's activities outside. If they remain with the other Romulans during this time, nothing of significance occurs until the Call to Challenge is given and the ritual combat begins. If, before that time, any of the Crew decides to walk around the grounds on their own, however, they may get more than they bargained for; with a Moderate Perception roll, the Crewman notices an open doorway in the distance, at the base of some sort of storage silo. In the doorway stands a tall, shaggy-maned individual with a skull-like face—unmistakably Nausicaan, and just as unmistakably out of place. He in turn sees the Crewman watching him, and retreats back into the building.

If following immediately, the Crewman (and any comrades) sees the Nausicaan disappear down a trapdoor in the silo floor. Chasing the Nausicaan requires any pursuers to descend into the underground corridor below, where two Nausicaan mercenaries armed with disruptors lie in wait; the PC's must fight their way free. If the Crewman instead goes back to the group for reinforcements, he must make a Challenging Search roll to find the trapdoor. If he goes for reinforcements after seeing the Nausicaan use the trapdoor, however, the Romulans may assault the Nausicaan hideout. Beyond the two guards at the entrance, who pull back if they see a superior force approaching, 48 other Nausicaan mercenaries hide within this labyrinthine complex of underground storage caverns (see sidebar for general statistics). There is a lot of cover available for both sides, and a protracted firefight is likely to result (the outcome of which may obviously affect later events).

Finally, if at any time the Crew reports the Nausicaan presence on-world to the ship, the bridge crew can begin scanning for the subtle sub-space emissions that emanate from a cloaked Nausicaan ship. This may wind up changing the timeline of events in Scenes Four and Five of this act, or in Act Three.

SCENE FOUR: HARD EVIDENCE

While the negotiations take place on the planet below, the bridge crew conducts long-range scans for signs of the missing Romulan freighter. For her own part, Lieutenant Kaya feigns little interest in the crew's activities, although in truth she knows exactly what they are up to (see "What Kaya Wants", above). She enters and leaves the bridge and asks probing questions often enough to make everyone nervous, to keep tabs on the search, but otherwise bides her time until the Crew finds something concrete to investigate. Since Agent Kaya elected to remain on board, the Crew might feel a need to proceed surreptitiously.

Each orbit of Gentara takes forty minutes to complete, and the best chance for a successful scan occurs halfway through each orbit, when the ship passes nearest to Mitos, Gentara's moon. For each skill level he possesses in Shipboard Systems (Sensors), allow the Crewman conducting the scan to make one Skill Test per orbit; thus, a PC with Shipboard Systems (Sensors) 2 (3) would make three rolls per orbit. Rolls made near the moon have a Moderate Difficulty, while all others are Challenging.

The Crew has three possible options to pursue once they identify Mitos as the place to search more extensively. (1) They can alter orbit to make a closer overflight of the moon, quickly pinpointing the precise location to be investigated, but at the risk of alerting Kaya and the

Gentarans. (2) They can dispatch a shuttle to Mitos from their current orbit and use the shuttle's own, more limited, sensors to search for the downed freighter; this takes more time to complete, but decreases the risk of detection. (3) Finally, the Crew can launch a sensor probe to conduct a close-range scan, then send a shuttle directly to the identified site. This option takes the most time to complete, as the shuttle cannot be launched until after the probe lands, but offers the lowest chance of detection.

Use supporting cast members as needed to apprise players of the options available, then step back and let them decide how to proceed. Remember to factor in the time taken to reach this decision into the overall timeline. The sidebar on page 14 summarizes the game mechanics associated with each option.

SCENE FIVE: A NOT SO BARREN MOON

Should the Crew pinpoint the site on Mitos to be investigated, they can transport down to the moon's surface (alternatively, they may elect to send a team of Supporting Cast members). At least one of the Crew might want to remain on board the ship, to keep an eye on Lieutenant Kaya. Mitos has no breathable atmosphere, so environment suits must be worn. The moon's surface is cold and stark, a relatively flat landscape of obsidian rock interspersed with the ice-filled canals of what once may have been rivers in eons past.

The landing party materializes near the freighter's wreckage. The ship's hull lies in pieces strewn across the moon's surface, and little that is usable remains (so the Crew cannot access the freighter's computer to find out what happened). Fully searching the wreckage requires twenty minutes to complete; at the end of that time, and once every additional ten minutes they continue the search, Crew members can make a Challenging Search roll (or Moderate Personal Equipment (Tricorder) roll).

If successful, the patrol determines not only that the freighter was shot down, but also that the cargo of disruptors is missing. Scanning the debris further, with another Moderate Tricorder Skill Test, the Crew also detects the presence of polarons in the burn marks on the wreckage. A Moderate Engineering Skill Test reveals that polaron residue is characteristic of ancient 22nd-century disruptors, commonly mounted on old birds of prey. The only species commonly using this model ship are the Nausicaans.

At this point, the players have achieved the scene's objective. If they accomplish the entire task in less than two hours and either notify the Romulans on Gentara or beam down to the planet, they can prevent the Call to Challenge from being issued and force the Gentarans to reveal the hideout of the Nausicaan mercenaries. Scene Six then begins with the attack on the hideout. Conversely, if the Crew requires more than two



and a half hours to complete these tasks, the conclusion of this scene spills beyond the start of Scene Six, and places the Crew at a further disadvantage.

Finally, as noted in the table, as the Crew draws closer to the truth other events may be set in motion. Once Kaya learns of the Crew's discoveries in the wreckage, she assumes a full-fledged rebellion is in the offing, and contacts the three warbirds cloaked nearby using her relay. She orders them to go to Red Alert status. She then proceeds to the bridge and invokes the *Tal Shiar's* emergency powers to commandeer the ship.

Note: If the Crew successfully tapped the agent's relay, they can interfere with her plans before she arrives on the bridge. Moreover, the Crew is unlikely to sit idly by while Kaya assumes command of their ship, yet they have little choice, unless they want to run afoul of the *Tal Shiar*. The Narrator should cut to the events on Gentara at this point, and resolve the situation in Act Six.

Armed with the information gleaned from the freighter wreckage, the Crew may decide to scan for cloaked ships in the area. While the *Tal Shiar* ships are Nearly Impossible to detect, the inferior Nausicaan cloaks emit tetryon particles, making them Difficult to detect. Two cloaked Nausicaan birds of prey orbiting Gentara watch the Romulan ship and try to figure out what to do.

They know the planetside timeline should take about two and a half hours to complete, and hope to remain hidden until the Gentarans give the signal and their comrades take the negotiating team hostage. Even with the modern firepower they have added to the ship from the downed freighter, they know they're no match for a warbird unless



GENTARAN CHAMPION

Attributes

Coordination 2

Fitness 4

Strength +2

Vitality +1

Intellect 1

Presence 3

Psi 0

Skills

Dodge 2

Primitive Weaponry (*Kamanta*) 4 (5)

Unarmed Combat (Brawling) 1 (2)

they attack with the element of surprise. Should the Romulan ship appear to detect them—changing course, for example—the Nausicaans attack immediately.

SCENE SIX: BURNT OFFERINGS

If the Crew locates the Nausicaan hideout, the ship in orbit locates the downed freighter before the Challenge is issued, or the Nausicaan ships attack the Crew's warbird, the negotiations abruptly end as word gets back to the Romulan negotiators. The proof of the Gentaran plot damns them with treason. Sorgun attempts to cut his losses by denouncing the *shaddath* for consorting with an enemy of the Empire, and encourages the Crew to go after the Nausicaans. To resolve these events, continue to Act Three.

Otherwise, once the *shaddath* issues the Challenge, the negotiators from both sides quickly fall out into the courtyard. The *shaddath* selects one of his guards as his champion, selects the pole weapons previously described (called *kamanta*) as the weapons of choice, and declares the challenge will be fought until one party cannot continue (through unconsciousness, incapacitation, or death). If the Crew have researched the Gentarans enough to know the rights of the challenged party, they can change these rules as they wish; otherwise, Sorgun has no intention of telling them, because he wants them to lose and give legitimacy to the rebellion.

Indeed, to ensure this result further, he tries to convince his chosen champion to accept an injection to "aid" his breathing in the stifling humidity. The hypo offered is the one stolen from sickbay, and the injection adds a negative adjustment to all combat and defense rolls, beginning at -1 in the third round of combat and increasing by an additional -1 each succeeding round.

Even if the PC does not fall for Sorgun's subterfuge, he still stands at a serious disadvantage in this fight, for he must use the *kamanta* (use the stats for the *lirash* from p. 64 of *The Romulans* without the Club option) as an untrained skill, using Coordination as his default rating when making Attribute tests. The fight commences as soon as both parties are outfitted and continues until one or the other fighter falls.

If the Romulan champion loses the challenge, the *shaddath* steps forward and proclaims, "The challenge verifies the righteousness of our claim, and proves that the Romulans have no place among us. As the prophecies foretell, today you shall fall before us, AS MESHAAAD WILLS!!" As he shouts his last phrase into a small communicator on his wrist, fifty Nausicaan mercenaries suddenly emerge from the surrounding buildings, while the native guards brandish their weapons as well.

The Crew and their security team counterparts are badly outnumbered, and taken by surprise. They can either surrender and be taken hostage, try to make a run for cover and hope to make contact with the ship and beam up later, or stand and fight. Sorgun advocates surrender to anyone who will listen. When the players decide their course of action, move on to Act Three.

If the player character wins the challenge, the *shaddath* steps forward and says, "You have prevailed in the Challenge, despite terrible odds. It is appropriate that this is so, for you are a man of honor, and I have sold mine like a fool to this prancing speaker of platitudes. Now my daughter is forfeit, and I have nothing to live for save vengeance. AS MESHAAAD WILLS!!"

As above, when the *shaddath* shouts his signal, the Nausicaan mercenaries emerge from hiding. The *shaddath* draws a curved knife from his sleeve and lunges toward the ambassador, but strikes nothing but air, as Sorgun disappears in the shimmer of a transporter effect; he beams aboard his own cloaked vessel, arranged for by the Suketh. See Act Three.

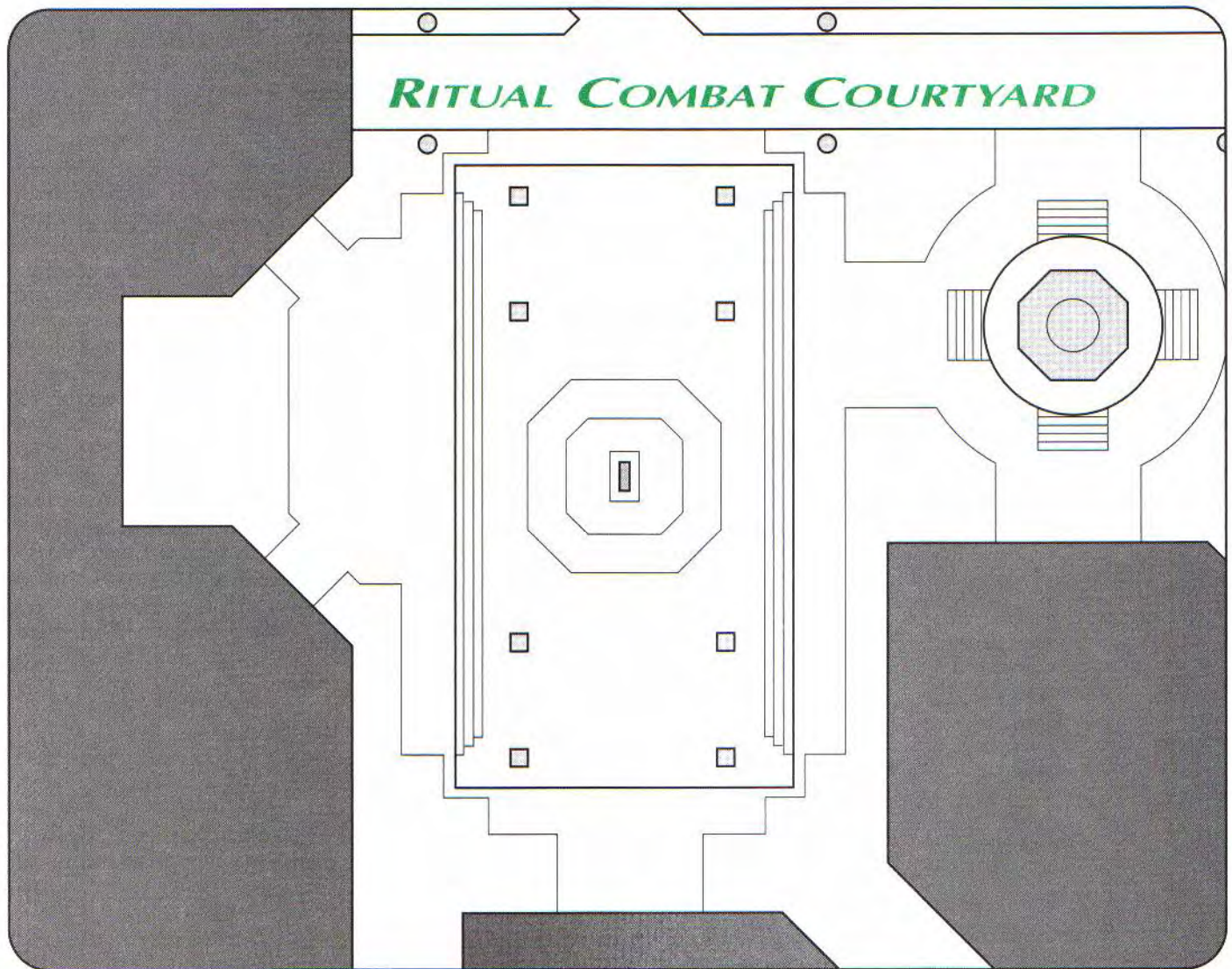

ACT THREE

SCENE ONE: CROSSFIRE

Depending on how events on Gentara unfold, Act Three may begin with anywhere from three to seven vessels preparing to engage in battle in Gentaran space, while on the island below the situation can range anywhere from a pitched firefight against the Nausicaan mercenaries, to the Gentarans seeking to negotiate concessions in exchange for their on-planet hostages.

In this concluding act, both situations should be resolved. Due to the number of variables involved, it is impossible to present detailed descriptions on how to resolve every permutation of the situations. A few key points need to be emphasized; these are detailed below.

TAKING CHARGE

Act Two ended aboard the Crew's ship with Lieutenant Kaya commandeering the warbird. This depends on her ability to convince the Crew of either her authority to do so, or the gravity of the situation. If the captain is a supporting cast mem-

ber, he readily hands over his ship. Although the Crew can oppose her efforts, this lands them in trouble with the *Tal Shiar*; they might, however, find alternate means to foil Kaya (by sabotaging the controls from the auxiliary bridge or taking the weapons offline, for example). Once she has command of the warbird, she commits her three *Tal Shiar* ships to the battle with the Nausicaan vessels. Alternatively, if Kaya is unable to assume command, she contacts her ships. While the *Tal Shiar* ships are technically on the same side as the Crew, and could prove vital to the outcome of the battle, nonetheless they are unconcerned about what happens to Crew members trapped planet-side once the assault begins.

Sorgun's position in the end game is determined by expediency. Unless the *shaddath's* denunciation forces Sorgun's hand in Act Two, Scene Six, he decides which side to back based upon who is winning. If the rebellion comes off as planned, he continues to cooperate in the plot. If the Crew seems to be carrying the day, he commits his ship to the fray to attempt to garner his own share of the glory. If Sorgun remains on the planet, he seeks an opportunity to kill the *shad-*

dath to keep him from talking. If he is exposed, Sorgun is preoccupied solely with saving his own skin and making an escape into the Neutral Zone.

The Nausicaans, though they have superior numbers at the outset of both fights, do not have superior skills. In space, they face only one Romulan warbird, and surprise may be on their side. On the ground, they either hold Romulan hostages or outnumber their opponents. Nausicaans are bullies who enjoy a good fight as long as they have the upper hand. Once Kaya's three ships decloak, the rebellion is essentially over. The Nausicaans turn tail and run. If the negotiating team has been taken hostage, the Romulans in orbit must recover them by brute force, with casualties likely. If the tide of battle turns against them, the mercenaries simply surrender. They have little stomach to fight to the last man.

Finally, the Gentarans' fatalistic view of the universe determines their interpretations of events. If the Crew succeeds in exposing the rebellion before the Challenge is issued, the *shaddath* and his forces simply conclude that this is not the day of their liberation. They surrender to their fate rather than wasting resources on a doomed cause. The *shaddath* keeps Sorgun's secret, hoping to use him again as a resource in the struggle. If the Challenge takes place and the players win, however, the Gentarans believe their Goddess has deserted them. If this is so, they must regain her favor by fighting the hated Romulan oppressors. But because it was Sorgun's plan, the *shaddath* believes Sorgun must die.

RESOLUTION

As is fitting for a mission with so many complex layers of intrigue, the Crew's rewards for this episode depend on how they interacted with each group—the Gentarans, the Nausicaans, Sorgun, and the *Tal Shiar*.

For preventing the Gentara Rebellion, reward each player with 2 Experience Points and 3 Renown (either to Aggression, Discipline, or Skill, depending on how they did it).

ADDITIONAL REWARDS

- For bringing back the *shaddath's* daughter to Romulus as tribute (thereby securing Gentara's long-term cooperation), give each player 1 Experience Point and 2 Discipline Renown.
- If the Crew secures a different tribute than the *shaddath's* daughter, mutually acceptable to both sides—the *shaddath* himself, another member of his family, or Sorgun (and his role in the rebellion), for example—give the players involved 1 Experience Point and 2 Initiative Renown.
- The Crew might establish criteria and a timetable for the Gentarans to receive full citizenship in the Empire, thus ensuring their long-term cooperation. Give each participating character 1 Experience Point and 2 Renown (Initiative), but -2 Aggression Renown.
- If the Crew discovers the Nausicaan involvement prior to the Challenge, give each participating character 1 Experience Point.
- For uncovering Sorgun's involvement in the rebellion, give each character involved the advantage Benefactor (Senator Kassus) +2.
- If the Crew somehow learns of Sorgun's motive—to demonstrate that the Empire should concentrate on current holdings before conquering new territories—and hides his involvement, give them the Advantage Ally (Sorgun) +2.
- If the Crew allows Kaya to take control of their ship, give the Crew Members one additional Experience Point.
- Should the Crew prevent Kaya from performing her duty, give Crew members a Disadvantage: Sworn Enemy (Kaya) -1.
- Any Crew members caught hacking into secure *Tal Shiar* files earn the Disadvantage Watched.

DUTY OR CONSCIENCE



Since its establishment some two hundred years ago, the Neutral Zone has served as a boundary between the Federation and the Romulan Empire, across which the military ships of both sides may not cross. It has become more than a simple line of demarcation—it has become a symbol of the tense political atmosphere between the Star Empire and the UFP.

In reality, while each side constantly patrols its own side of the border, daring traders attempt to run the gauntlet, to trade rare commodities for high profits. Officially the Federation fines and seizes any ship caught carrying contraband from the Romulan Empire, but with the large number of small colonies and outposts along both sides, many smugglers can get in and out quickly without getting caught.

The Romulans quietly allow small merchant ships to enter their space—sometimes using them to infiltrate the Federation—but seize larger vessels. Both sides, however, treat incursions into the Neutral Zone by warships as a serious matter.

In its long history, only four or five incidents of military ships entering the Zone have occurred. Despite these rare instances, both sides consider the treaty a success. The Romulans use Starfleet violations of the treaty to try to embarrass the Federation, while denying forays across the border by their own starships. This political gamesmanship typically only applies to individual vessels caught crossing the zone. Were an entire fleet detected entering the zone, it would result in a declaration of war.

BACKGROUND

With the creation of the Neutral Zone, the Romulans surrendered control of a dozen small colonies and outposts. As the Federation explored these systems, scientists learned of the harsh methods the Romulans had used to exploit and subjugate the less advanced and primitive species they discovered. In some cases, the Romulans exterminated entire species, under the guise of “pacification.”

As more information became known, researchers presented their evidence to various Federation agencies. The Federation could do little to pursue these allegations, as the Romulans don’t discuss their internal affairs with outsiders. Dr. Valerie Byron, an exoanthropologist, is one of several scientists frustrated with the Federation’s inaction.

Captain Rukin of the merchant ship *Purveyor* is a long-time friend of Dr. Byron, and one of the few people outside of her research group Dr. Byron trusts. On a recent foray across the Neutral Zone, Rukin learned of Romulan plans to conquer Kir I, home to a primitive species called the Arnu. Rukin informed Dr. Byron, who decided to take matters into her own hands. Because of Rukin’s familiarity with Romulan space, she enlisted his aid in a bold plan to resettle as many Arnu as she could in UFP space.



SYNOPSIS

What begins as an investigation into illegal weapons smuggling evolves into a series of events that could lead to war between the Federation and Romulan Star Empire. The story begins when the Crew's ship responds to a hail from Tyrus I, a small Federation mining colony on the border of the Arteline Sector and the Laikos Extension. Colony officials hold two associates of a Ferengi weapons dealer named Omag on assault charges. While investigating the incident, the administrator, William Landeau, uncovered rumors suggesting their involvement in an arms shipment passing through the colony. Concerned, Landeau contacts the Crew's ship asking for assistance.

When the Crew's ship arrives Landeau is as helpful as possible. Landeau wants the away team to find evidence in order to charge Omag's henchmen with weapons smuggling. Without this evidence, Landeau can prosecute only the assault charges. During the course of their investigation, the Crew finds proof not only of the arms smuggling, but its destination—a research station on Audron IV. Their duty is clear: Stop this shipment and arrest the smugglers.

The Audron system is a small star system located in the Laikos Extension. A small, subtropical world, Audron IV is presently being evaluated for possible colonization. Dr. Valerie Byron, a noted exoanthropologist, leads the science team evaluating the planet and surveys the planet for sapient lifeforms.

Arriving in the system, the Crew's ship finds the merchant vessel *Purveyor* in orbit around Audron IV. Hails to the planet initially go unanswered, until the *Purveyor's* captain, Rukin, invites the Starfleet crew down to the surface. Rukin meets the Away Team in an open field

AUDRON SYSTEM

Affiliation: None

System Type: K3 V

Inhabited Planets: None

Other Planets: Audron I (Class F), Audron II (Class K), Audron III (Class J gas giant), Audron IV (Class M)

Other Stellar Objects: Small asteroid field

Artificial Objects: None

SIS: A system with excellent prospects for fruitful mineralogical development

about half a kilometer from the research station. Believing he has nothing to lose, Captain Rukin reveals the presence of the Arnu and explains their plight.

Both Rukin and Dr. Pilish, Dr. Byron's assistant, admit to Dr. Byron's plan to transplant this primitive reptilian species from their home in Romulan space to Audron IV. Instead of confronting the Romulans, Dr. Byron has been moving small groups of Arnu on Rukin's ship from Kir I to Audron IV. In fact, Dr. Byron is there now, arranging for another group of Arnu to make the dangerous run. Dr. Pilish tries to persuade the Crew to help; it's only a matter of time before a Romulan pacification force arrives to "secure" Kir I.

The Crew must decide what to do. Will they arrest Rukin, Pilish, and the other scientists on Audron IV, leaving Dr. Byron stranded in Romulan space? Will they venture beyond the Neutral Zone to bring Dr. Byron back themselves? Or will they assist the conspirators in their efforts to preserve an alien species? How will they get

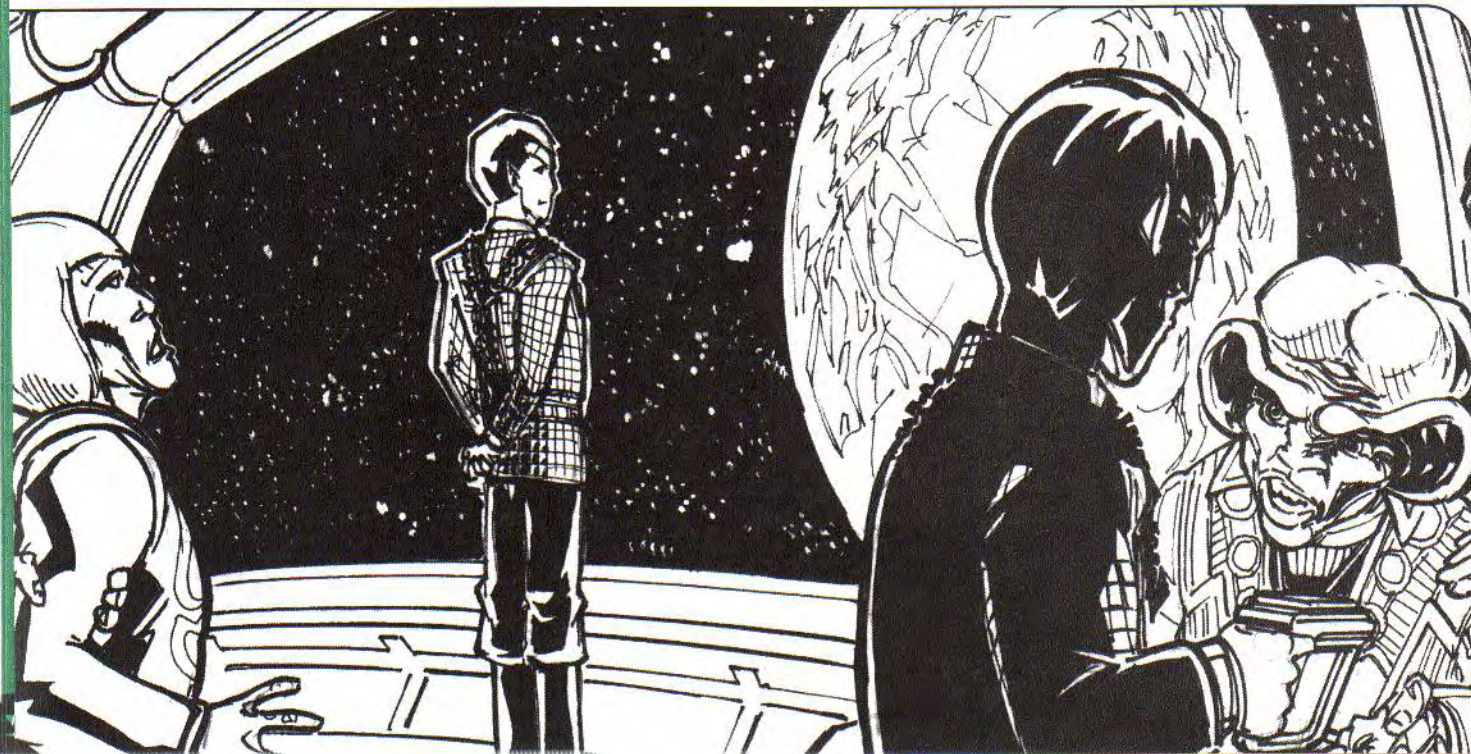



into Romulan space? Finally, how will the Crew respond if the Romulans catch them in Romulan space?

Assuming that the Crew agrees to assist the evacuation effort, the finale takes place on Kir I. Dr. Byron is displeased to see Starfleet, but with Romulan troops on the way, she makes every effort to win them over to her cause (if they are not already). Dr. Byron needs all the help she can get to succeed in smuggling this last group of Arnu into the Federation.

In this episode, the Crew faces a moral dilemma in the classic *Star Trek* tradition. Dr. Byron's actions already violate the Prime Directive. Faced with this dilemma, will the Crew further violate the Prime Directive to save the Arnu, or oppose Dr. Byron's efforts in the name of the Prime Directive?

ACT ONE: WEAPONS!! WHAT WEAPONS?

While on patrol along the Neutral Zone, the Crew receives a hail from a Mr. Landeau, administrator of the Tyrus I colony. He reports arresting an Andorian and a Ferengi for assault and disturbing the peace after a fight in a local bar. While the captain and Crew might rightly wonder what this has to do with them, Landeau explains the reason for his call. During the course of the investigation,

he learned of the activities of an illegal arms merchant operating in the sector. Landeau wanted to alert Starfleet to look into the situation, and asks the starship to stop at Tyrus I.

The trip to the colony requires only a slight diversion from the ship's present course, and nothing pressing prevents them from honoring Landeau's request. Traveling at warp factor 8, the Crew's ship can be at Tyrus I in 36 hours (the colony lies four light years from their present position). During the journey, the Crew can research Tyrus I, requiring a Routine Computer (Research) Skill Test.

Established ten years ago, with a population of approximately two thousand inhabitants, this mining colony mines pergium. The planet's rocky deserts and spectacular sunsets, reminiscent of the North American Southwest on Earth, also attract a small number of tourists every year. Most of the colony's inhabitants are human, with a smattering of Vulcans, Andorians, and Tellarites.

After establishing a standard orbit around the planet, the Crew beams down to a small town square near the colony's docking facilities. It's early afternoon, and quite hot. William Landeau, a lanky man dressed in a miner's coveralls, waits to greet the Away Team. He introduces himself and suggests the group move to his office, where it's much cooler.

As they follow Landeau, the Crew has an opportunity to survey the colony. It is a jumble of building styles, ranging from Starfleet prefabricated housing to buildings constructed from the local stone. Off in the distance the towers of a pergium processing plant rise into the deep blue sky. A small Merchant Marine freighter rests on one of three landing pads between the town and the plant.

Landeau leads the Crew into a featureless, four-story office building and takes them upstairs to his office, where it is much cooler. The office is well appointed and spacious, and has a nice view of the colony and the cliffs beyond. Being a gracious host, Landeau offers the Away Team a seat and something to drink.

Once the Crew settles, Landeau spells out his information: Two days ago, a couple of traders got into a fight at a local bar. As the local constable took statements from witnesses, he heard rumors the two may have been involved in an illegal weapons sale. After their arrest, the men stopped talking and refused to answer questions, though one of them let the name "Omag" slip. So far Landeau has been unable to find any hard evidence, or get the prisoners to talk. Perhaps Starfleet would have better luck.

Wanting to be as helpful as he can, Landeau provides the Crew with a list of principal witnesses to talk to. Narrators should rely primarily on roleplaying when presenting the information below, rather than on dice rolls. While the people on Landeau's list are generally helpful and willing to talk, the information they provide depends on

RUKIN**Attributes**

Fitness 2

Strength +1

Coordination 3

Reaction +1

Intellect 3

Perception +1

Presence 2

Willpower +1

Psi 0

Skills

Administration (Starship) 2 (4)

Command (Starship) 3 (4)

Culture (Human) 1 (2)

(Romulan) (2)

Diplomacy (Neutral Zone) 2 (3)

Dodge 2; Energy Weapon (Phaser) 1 (2)

Law (Romulan Regulations) 2 (2)

(Starfleet Regulations) (3)

Merchant (Frontier) 3 (4)

Persuasion (Negotiation) 2 (4)

Shipboard Systems (Command) 2 (4)

(Weapons) (4)

Social Science (Political Science) 1 (2)

Starship Tactics (Starship) 3 (4)

Systems Engineering (Warp Drive) 2 (3)

Advantages/Disadvantages

Resolute +3, Impulsive -1

Equipment: Type I Phaser (has license with Starfleet), communicator, and two PADD's**Description:** Captain Rukin was once enrolled in Starfleet Academy, but quit after two years. His father, a starship captain, disowned him. With the last of his savings, Rukin purchased the *Purveyor* and started hauling cargo along the frontier. Starfleet Intelligence suspects him of smuggling Romulan ale across the Neutral Zone, though it has been unable to prove this allegation. He has a reputation as a fair businessman who is easy to deal with. His friend, Dr. Byron, depends on his knowledge of Romulan space, and running the border, to make her plan a success.Rukin has modified his ship, the *Purveyor*, with a second phaser bank and faster engines (Warp System 5.0/7.0/9.0 [6 hours]), and has increased its shield strength to 40.

the questions the Crew asks. Each entry contains the information known to the character, though Narrators should feel free to embellish as needed.

SEYMON

A Ferengi entrepreneur, Seymon moved to Tyrus I a few years ago, to open a bar called Seymon's Inn. He hoped to take advantage of the growing population of workers and tourists. Being on the fringes of Federation space, and the lucrative opportunities this provides, didn't hurt, either. Landeau doesn't want Tyrus to get a reputation for the kind of wild activities that happen on other mining worlds, so he keeps a close eye on Seymon's place.

The bar stands near the cargo containers used to store processed pergium. It's a small, domed building with a traditional (short) Ferengi door, so tall visitors must stoop to enter. Like many Ferengi establishments, Seymon's place has *dabo* tables and holosuites, and has become quite popular with the locals. Depending on the time of day, Seymon's could be empty, or filled with customers.

It was Seymon who told the constables about the reputed weapons deal when they arrested the two traders. While Seymon volunteered the information to stay on Landeau's good side, he is also upset that Omag didn't offer his usual fee to Seymon to safeguard the transaction. He thought Omag would simply lose a single shipment of weapons, and kept the arms merchant's name out of his story. Now that Starfleet is involved, Seymon lies low and waits to see what happens.

Getting him to talk requires a credible threat—of increased scrutiny of his bar, for example—or a successful Moderate (7) Persuasion Skill Test. Seymon knows exactly what Omag has been up to, and fears his retribution for talking (though he fears Starfleet more). He has no idea whom Omag sold his latest shipment to; he didn't even know the two rowdies were Omag's employees. Naturally, Seymon covers up his role as middleman in the smuggling operation.

ANNA, THAYA, AND ORNIDA

Seymon's *dabo* girls, these three lovely ladies served Omag's associates for most of the evening in question and heard most of the boasts they made about their recent deal. A successful Routine (4) Charm or Persuasion roll, or a good-sized tip, convinces the women to recall what they observed.

According to the girls, things were all right until the Andorian started grabbing at them. Seymon had to get involved, and that's when he called the police. Before they got too drunk, both men boasted about selling state-of-the-art weapons at four times the going price to some freighter captain. Both were certain they would be selling him more weapons for the same high prices in the near future. Thaya asked who their buyer was, trying to make polite conversation, but neither man would say. Then the fight broke out.

STAV

This Vulcan man runs a small equipment exchange and repair shop near the colony's repair facilities. Stav is pretty straightforward, and won't need much encouragement to talk about what he saw. Stav usually comes to Seymon's for a glass of Vulcan port before going home.

By the time Stav came into the bar on the night in question, both the Ferengi and the Andorian were well into their drinking. He recognized them from earlier in the day, when he had seen them with a human man. He remembered the man because he'd purchased a

replacement photon particle dampener the day before—the captain of the *Purveyor*. Stav left just as the Andorian started getting rowdy, so he saw little of the altercation; he apologizes for not being able to tell the Crew about the fight.

GOICH AND ZAPH

The two prisoners from the fight sit in the colony's small jail. It's a simple matter for the Crew to talk to Goich, the Andorian, and Zaph, the Ferengi; asking the colony's constable is all it takes.

At first, the two say nothing to the Starfleet officers, opting to sit impassively in their cells; neither likes people in uniform. They may talk, however, if given the proper incentive. The Crew could offer them immunity from prosecution for the arms smuggling charges, for example, in return for information; leading the two to believe that Starfleet isn't interested in flunkies, just their boss Omag, gets Goich and Zaph to open up. While the two are talking, it's easy to get them to reveal all they know about the transaction.

The two of them accompanied the weapons shipment carried by one of Omag's freighters earlier in the week. They then waited around until their buyer arrived—a freighter captain named Rukin. The shipment included sixteen compression phaser rifles, twenty-four type II phasers, five tryton pulse emitters, and a case of gravitic mines.

Rukin didn't say what he wanted the weapons for. He paid them, then loaded the goods into his ship and took off. That night, the two of them went to Seymon's Inn to celebrate. Goich didn't know one of the dabo girls had a boyfriend, and certainly didn't know he was in the bar.

While the Crew uncovers enough information to begin an investigation into Omag, their inquiry opens up a new can of worms. Who is Rukin? And what does he want with so much firepower? It's up to the Crew to find out.

BRENESH

The colony's port master is a very busy Tellarite named Brenesh. The Crew can find him scurrying about the docking facility, checking on maintenance schedules, double-checking the engineers' repairs, and generally fretting about everything. He's the person they need to see to gain access to the spaceport's logs, which can tell them when the *Purveyor* left and where it was going.

The Crew can gain Brenesh's cooperation by offering to help him with the work, but any Crew member who makes such an offer has to be skilled (in Engineering: Propulsion (Warp Drive) or Systems Engineering (Sensors), for example), to meet Brenesh's high standards. Narrators should have the helpful Crew members make several Moderate (8) Skill Tests using their Engineering skills; Brenesh needs help repairing a Merchant

Marine ship. The precise nature of the repairs, and the time it takes to complete them, are left to the Narrator's discretion. If he's satisfied with the job they've done, he lets them access his computer logs. (If they cannot get the information from Brenesh, then have someone else at the port remember the details).

Finding the information they're looking for calls for a successful Routine Computer (Research) Skill Test. According to the flight plan Rukin filed, he was bound for Audron IV. (They have to hope Rukin filed an accurate flight plan.) A successful Routine Space Sciences (Astrogation) or (Stellar Cartography) Skill Test places the planet five days' journey from Tyrus I (at warp 6). Colony records indicate the *Purveyor* departed three days ago (on the day of the fight).

Landeau has his proof against Omag, in the form of his associates' confession, and Starfleet will likely pick up the Ferengi arms merchant (perhaps even involving the Crew in a future episode). Landeau thanks the Crew for their help before they return to their ship.

Armed with evidence of a large quantity of weapons being smuggled to Audron IV, the Crew might approach their captain or Starfleet Command (if one of the Main Cast plays the captain). Naturally, both the captain and Admiral Keil of Starbase 39-Sierra (see **A Fragile Peace**) want to get to the bottom of the situation, and propose pursuing Rukin and the *Purveyor*.

ACT TWO: PLAYING CAT AND MOUSE

The Crew's ship takes as little as two days to reach Audron IV (at warp 8), one day if they want to push their engines to warp 9. During this time Crew members may opt to research the Audron system in the LCARS system (a Computer (Research) Skill Test against a Routine (4) Difficulty).

Mapped approximately ten years ago, explorers have only recently begun studying the Audron system. The Audron system, orbiting a type K star, is one of eight systems that make up the Laikos Extension. General mineralogical surveys revealed all three had substantial mineral deposits of various kinds. Because of the interest in putting a colony on Audron IV, the only Class M planet in the system, five years ago the Federation assigned Dr. Valerie Byron, a well known exoanthropologist, to explore Audron IV to ensure that no sapient life was present.

The Prime Directive requires all planets slated for colonization be studied this way, to ensure that no violations occur. The planetary survey team totals approximately a dozen scientists, all engaged in evaluating the planet.

Arriving in the system, a Moderate (7) Shipboard Systems (Sensors) test by the Conn or Science Officer finds a ship in orbit around Audron IV and identifies the research station on



DR. BYRON

Alternatively, the crew could beam Dr. Byron up to the ship, by locking on to her life signs. Beaming Dr. Byron up only angers her. As soon as she materializes in the transporter chamber, she rails against being taken before she has completed her work.

She wants to return to the surface of the planet and collect a group of Arnu. (Again, this could run counter to the Crew's plan simply to rescue Dr. Byron). If the Crew elects to depart with only Dr. Byron, the adventure essentially ends here; have the Crew retrace their steps back to the Federation, making the same Skill Tests used to get here. (Narrators can still make this tense and climactic by leaving the question of Romulan discovery open). If the Crew agrees with Dr. Byron, they beam down to Kir I.

the planet. The ship's navigational beacon identifies it as the *Purveyor*. A second Moderate (8) Shipboard Systems (Sensors) test by the Conn Officer classifies the *Purveyor* as an *Antares*-class freighter, though modified with faster engines, that doesn't appear to be hiding. The Crew can attempt to hail both the *Purveyor* and the research station.

The *Purveyor* responds by informing the Crew that Rukin is not on board; he's beamed down to the planet below. The hail to the research station goes unanswered. After several minutes futilely attempting to contact the planet, the Crew might suggest scanning the surface for life-forms. A successful Routine (5) Shipboard Systems (Sensors) Test result identifies a dozen humans in and around the station, as well as ten times that number of other, unidentified lifeforms.

A further, more detailed scan (an Extended Shipboard Systems (Sensors) test made against a Moderate (7) Difficulty, requiring a total test result of 21) reveals the other life forms to be warm-blooded, non-human bipeds. A Computer (Research) Skill Test against a Routine (6) difficulty shows the readings don't match any species currently in Federation records.

Alternatively, the Crew might argue to forgo any sensor scans and beam down directly to the research station. If this occurs, move on to the next scene.

TALKING WITH RUKIN

While the Crew scans the planet below, someone from the planet finally answers the ship's hails. When patched through, a man's face appears on the view screen. He introduces himself as Captain Rukin. He apologizes for not responding to their messages sooner, blaming unspecified "technical difficulties." A successful Opposed Test pitting a psionic character's Receptive Telepathy or Receptive Empathy skill against Rukin's Presence betrays Rukin's lie: The research station personnel simply ignored the messages, playing for time. If any crew member asks about the strange alien species, Rukin claims to know nothing about the native life on Audron IV (again, he's lying).

The Crew likely has dozens of questions for Captain Rukin, which he puts off by saying "all in good time" in a reassuring tone. He invites an Away Team to beam down to the research station, where he promises to answer all questions.

At this time, the Crew should be encouraged to discuss their opinions. The Narrator (acting as captain) should ask the Crew to look at various options and courses of action. It's clear something strange is happening here, but the captain should keep the discussion focused on the questions at hand: Why would a research station need weapons? Who are the unidentified lifeforms on the planet? At the end of the meeting, the Crew should select an Away Team to beam down and meet with Rukin.

ON THE PLANET

Beaming down just beyond the research station, the Away Team finds Rukin standing on the edge of a large field. In the distance, two scientists appear to be taking soil samples. The sky is overcast, and it looks like it could start raining any minute. A gentle breeze makes the air a bit cool. As they approach, the Crew may note, with a successful Perception Test, that Rukin is watching them carefully. Rukin nonchalantly welcomes them to Audron IV.

Captain Rukin feels he has nothing to lose at this point. He and Dr. Byron have successfully smuggled 120 Arnu from their home on Kir I to Audron IV. He believes if he shows the Crew the Arnu, if he can win them over to their side, the Crew will turn a blind eye to Byron's operation. If they try to stop the plan, Rukin can always take the Crew hostage. Thus, he's open and friendly with the Crew, and he's eager to show them the Arnu.

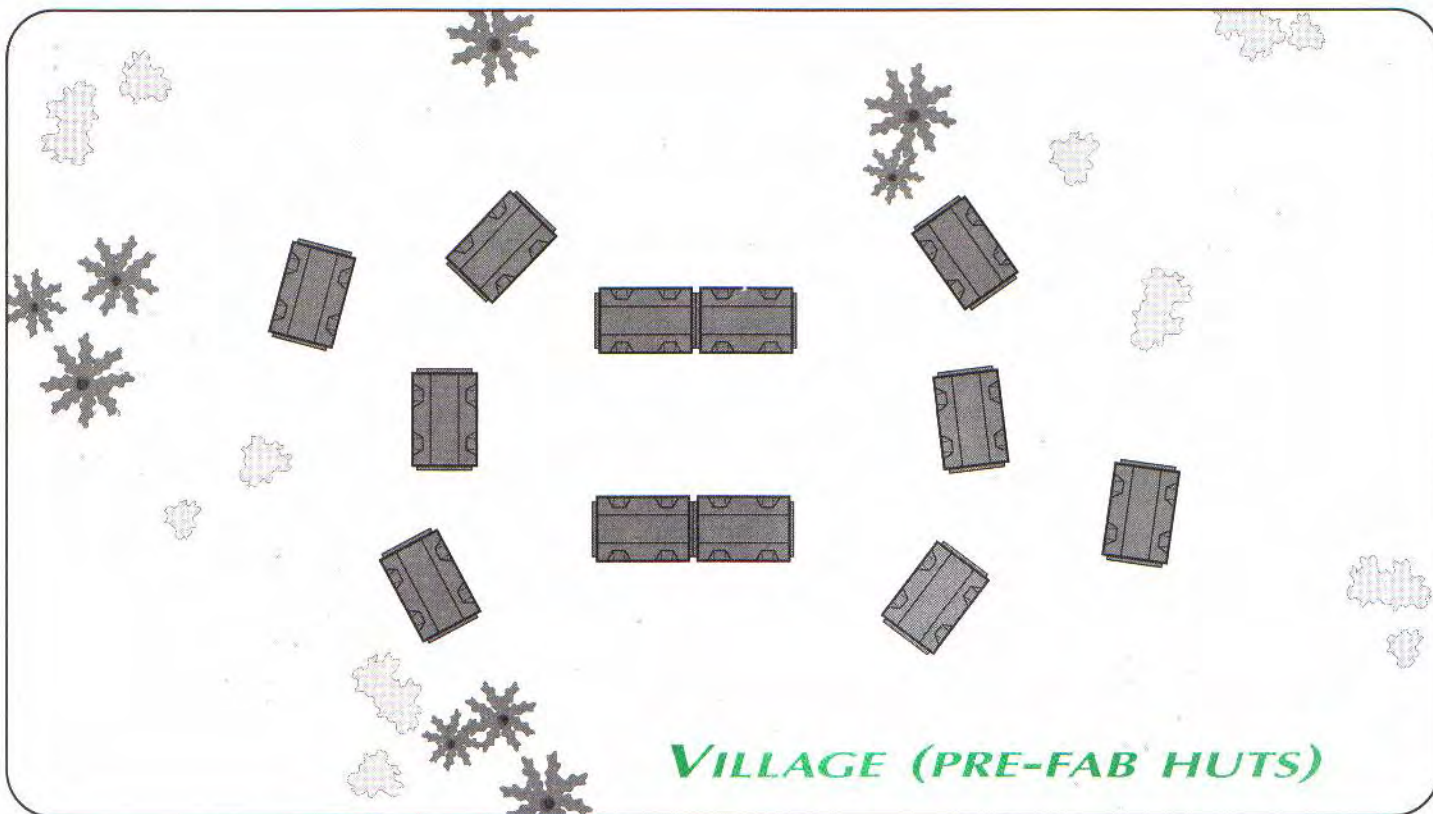

VILLAGE (PRE-FAB HUTS)

Accounting for all the possible interactions between the Crew and Dr. Rukin is impossible. The Narrator should allow the flow of the game to evolve out of the interplay between Crew and supporting cast. Two things, however: If the Crew asks to speak with Dr. Byron, Rukin refuses, claiming she's on a survey expedition in the mountains. Any questions about the weapons from Tyrus I draws a confused, surprised response from Rukin. He claims to know nothing about any weapons.

Rukin offers to show the Crew around. He shows them the research station, with its scientific equipment, and introduces the Crew to various scientists conducting their experiments. Nothing appears out of the ordinary. During the tour, he deflects any questions until he can show them the answers.

He walks across a meadow of waist-high grasses and over a small rise. At the top of the hill, he directs their attention to a small village of prefabricated huts used by Federation colonies. The Crew observes some thirty tall, thin, bipedal lizards milling about the village. These, Rukin announces, are the Arnu.

As the group moves down the hill and toward the village, Rukin explains that the Arnu are not native to Audron IV. A little more than a year ago, he and Dr. Byron started moving small groups of Arnu from their homeworld to this planet. They're indigenous to Kir I, a small group of planets a scant three light years from the Neutral Zone, in Romulan space. (Any Crew member can make a successful Space Sciences (Astrogation) Test against a Challenging Modifier (9) to know this.)

When Dr. Byron learned that the Romulans planned to conquer the Arnu, thus destroying their unique culture, she asked Captain Rukin to help her smuggle out as many Arnu as they could. He agreed, and the results are apparent, he says, indicating the village.

When the Crew enters the village, the Arnu become highly agitated. They make birdlike chirps at the Away Team and press closely around them. Some merely stare curiously, while others carefully sniff the Crew. Others make more threatening moves. Rash PC's might lash out, thinking the Arnu mean them harm; if any Crew members strike out at the mob, the Arnu attack en masse. Smart PC's adopt a "wait and see" attitude. Suddenly, a man appears from inside one of the huts and begins chirping at the Arnu. They seem to understand his meaning, and the Arnu retreat. The man extends his hand and introduces himself as Dr. Pilish, Dr. Byron's assistant.

The two men—Rukin and Pilish—show the Crew around the village. Dr. Pilish explains that the Arnu meant them no harm, that they were merely curious about the Crew. The Arnu appear to be a reptilian or amphibian species, and possess a leathery skin and webbed feet and hands. Although the Arnu appear to go about their business, a successful Routine (5) Perception Test reveals they continue to watch the Crew and chirp among themselves.

Rukin points out interesting aspects of Arnu culture—the intricate grass weavings they use to decorate their doors, an Arnu grinding leaves with a stone to make *kava* (an Arnu drink), Arnu children playing a game—in an attempt to get the



DR. VALERIE BYRON**Attributes**

Fitness 2

Vitality +1

Coordination 3

Reaction -1

Intellect 4

Presence 3

Empathy +1

Psi 0

Skills

Administration (Federation) 2 (3)

Charm (Influence) 2 (3)

Computer (Research) 3 (4)

Law (Federation) 1 (3)

Life Sciences (Biology) 1 (2)

Persuasion (Debate) 1 (2)

Social Sciences (Exoanthropology) 2 (5)

(Political Science) (3)

Personal Equipment (Tricorder) 2 (3)

Shipboard Systems (Sensors) 1 (3)

Systems Engineering (Sensors) 1 (2)

Advantages/Disadvantages

Bold

Code of Honor (Defender)

Strong Will

Equipment: Type II hand phaser, standard tricorder, medical kit, hand-held communicator, various PADD's

Description: Dr. Byron received her degree in exoanthropology from the Daystrom Institute, and went on to distinguish herself as an expert in the study of nontraditional lifeforms. She's been living on Kir I for just over a year, and has established a solid friendship with a large tribe of Arnu.

It is they whom she transplants to Audron IV. She believes the protection of life is the Federation's highest purpose, and that the Prime Directive was never intended to justify the extinction of a civilization. She has no patience for platitudes.

Crew to empathize with the Arnu. His meaning should be plain: If they hadn't rescued the Arnu, Arnu culture would die.

A Perception test against a Routine (4) difficulty shows the researchers working with the Arnu, showing them how to use primitive tools. With a second successful Perception test, Crew members also notice the occasional Arnu armed with a phaser compression rifle or type II phaser.

THE DEBATE

The central purpose of this episode is to get the Crew (and the players) to debate the Prime Directive. The Narrator should assume the role of Dr. Pilish and argue his side (summarized below). This debate should be based on character interaction, but Narrators can use Persuasion, Oratory, or Diplomacy Opposed Skill Tests if they wish to. Narrators should also watch any Crew members with Code of Honor (Starfleet), to make sure they adhere to it. It's important to note here that Worf's half-brother, Nikolai Rozhenko, similarly evacuated a primitive species to save them from extinction in the episode "Homeward" (TNG).

Dr. Pilish feels Starfleet has not lived up to its promise to protect life. He's an idealist, believing that the Federation sits by while the Romulans destroy other civilizations. Dr. Pilish understands why the Crew might feel helping the Arnu violates the Prime Directive. He doesn't agree, arguing that allowing a species to be exterminated was never intended by the Prime Directive. He admits the risks are great, but contends the value of saving the Arnu is also.

At this point, Dr. Pilish reveals that Dr. Byron is not in the mountains on a survey mission. She's on Kir I, arranging to bring back another group of Arnu. At worst, he and Rukin hope the Crew will turn a blind eye and allow them to make one more run into the Neutral Zone. At best, they hope the Crew sees things their way and joins them in their attempt to save even more Arnu; after all, a starship can carry far more people than a freighter.

ACT THREE: CONSCIENCE**GETTING IN AND OUT**

Events in the third act depend largely on the Crew's decisions. They could choose to arrest Rukin and Pilish, and leave Dr. Byron stranded. Or they could choose to side with the conspirators. They might decide to risk their own starship, or join Rukin's crew for one last smuggling run. Does the Crew violate the Prime Directive to help save a civilization from destruction?

THE CAPTAIN

Before moving on, the Crew must consult with their captain. One of the benefits of the Narrator playing the captain is that he gets to make decisions on the captain's behalf. If the Crew wants to go along with Rukin and Pilish, the Narrator can portray the captain as swayed by their arguments. If the Crew objects to Byron and Pilish's interpretation of the Prime Directive, he can reinforce their decision by having the captain agree with them. Be careful, however. Players don't like to feel railroaded: If they don't want to go into the Neutral Zone, and the supporting cast captain orders them to do it, they'll follow his orders. But they won't like it.

If, on the other hand, one of the players portrays the captain, the entire episode could be decided on his word. If he disagrees with the course of action desired by the rest of the group—objecting with Dr. Byron's position and refusing to enter the Neutral Zone, for example—he can order the Crew to follow his course of action. Captains give orders and expect their officers to follow them. Narrators, consider

yourselves forewarned: The Crew could find itself doing something it doesn't want to do because of one player's decision (which is, in itself, a role-playing challenge).

THE CREW IS AGAINST

If, in the end, the Crew decides against participating in the plan, the adventure effectively ends here.

MAKING ARRESTS

The Crew decides not to participate in retrieving Dr. Byron. They arrest Captain Rukin and leave the Audron system with the *Purveyor* in tow. Dr. Pilish is arrested for violating the Prime Directive, as well. The only postscript will be a news service report announcing the arrest of Dr. Valerie Byron by the Romulans on espionage charges. Ironically, the Federation Council sends exoanthropologists and other experts to help the Arnu on Audron IV, and the planet becomes a thriving colony.

Alternatively, when the Crew moves to arrest Rukin and Pilish, the Arnu armed with the illegal weapons obtained on Tyrus I attack as a group. Pilish instructs them to take hostages, which he tries to use as bargaining chips against the starship's captain. In this scenario, Pilish hopes to hold off any Starfleet interference until Dr. Byron can be retrieved. Meanwhile, the *Purveyor* beams Captain Rukin aboard, attacks the Crew's starship, and makes a run for the edge of the Romulan Neutral Zone.

WAIT AND SEE

In this scenario, the Crew rejects participating in the plan, but does nothing to stop Captain Rukin from entering Romulan space. They simply wait for the *Purveyor* to return with Dr. Byron and more Arnu, then arrest her, Rukin, and Pilish. Whether or not they succeed is left up to the Narrator.

As above, the *Purveyor* might elect to attack the starship when it returns, in hopes of destroying it. Or when the Crew beams back down to Audron's surface to arrest the conspirators, the armed Arnu attack. In this way, Dr. Byron hopes to shed light on the plight of the Arnu and draw attention to the injustice of the Prime Directive.

THE CREW IS FOR

On the other hand, the Crew might join Captain Rukin and Dr. Pilish, and the episode continues into Romulan space. This decision has further ramifications: Should they risk using their starship in crossing the Neutral Zone, or will they use Rukin's ship? The Narrator should be aware of those characters who have Code of Honor (Starfleet). They should have a difficult time participating further in this adventure, and roleplay it.



THE PURVEYOR

To cover up any Starfleet involvement, the Crew might elect to use Rukin's ship to violate the Neutral Zone. Rukin is willing to let an Away Team join his Crew, but if the Romulans stop the *Purveyor* they may discover the Starfleet officers. He points out that he has been stopped before, and the Romulans have files on his crew. They may be suspicious of any "new" crew members. They are unlikely to be swayed by arguments of Starfleet's lack of involvement. The result could be disastrous, depending on the Romulan centurion with whom they deal.

The trip from Audron IV to the Neutral Zone—a journey of fifteen light years—takes six days at warp 8, plenty of time for the Crew to familiarize itself with the *Purveyor* and her crew. The mood on the ship is light and easy, despite the seriousness of the task before them; Captain Rukin commands with a light hand, and his crew of twelve know their jobs. The precise details of the trip—any encounters with the *Purveyor's* crew, for example—are left to the Narrator; this would be a perfect time to introduce a recurring supporting cast character.

Although the Romulans patrol the Neutral Zone zealously, and maintain an extensive network of sensor arrays and outposts, Captain Rukin knows exactly how and where to slip across the Zone and into Romulan space. The Flight Control officer should attempt a Challenging (10) Ship Systems (Flight Control) Skill Test. The Narrator

CENTURION MALVEC**Attributes**

Fitness 3

Strength +1

Coordination 3

Intellect 3

Perception +1

Presence 3

Empathy -1

Psi 0

Skills

(only those skills likely to come up in this adventure are shown)

Command (Romulan Warbird) 2 (3)

Persuasion (Oratory) 1 (2)

Starship Tactics (Romulan) 3 (4)

World Knowledge (Arteline Sector) 2 (3)

Description: Malvec is a career officer who once had his eye on a Senate seat, until his commanding officer, Admiral Jarok, defected to the Federation. Since then all of the commanders under Jarok have suffered a loss of status within both the military and Senate; some lost their commands, while others have had their promotions blocked.

So far Malvec has managed to keep command of the *Vigilance*, but tires of the small unrewarding assignments he's been given. Despite his situation, Malvec blames the Federation. Jarok may have been weak, but the Federation took advantage of his weakness. Although Malvec wants to make the Federation pay for what they've done to his career, he's also wary of further damaging his career—making him cautious.

should add 7 to the test result, and note the total. This is the total amount of hours the Away Team can be at Kir I before the Romulans arrive.

Once they enter the Neutral Zone, the trip to the Kir system (a total of four light years) takes an additional 38 hours at warp 8. Once they cross into Romulan space, the mood on the ship becomes tense. Captain Rukin encourages everyone to relax. After all, he doesn't want to give the Romulans a reason to be suspicious. To ratchet up the tension a bit, the Narrator can have a Romulan border outpost contact the ship (in a scene reminiscent of the *Enterprise-A's* trip to Rura Penthe in "The Undiscovered Country"), mention the warbird a few hundred thousand kilometers away, or spook the Crew with either mundane requests or sensor ghosts.

THE STARSHIP

Rather than Rukin's freighter, the Crew may opt to use their own starship to pass into the Neutral Zone, despite the potential for war, because of the ship's superior performance and larger cargo capacity. A Starfleet vessel in the Neutral Zone is a clear violation of the Treaty of Algeron, and although in the past the Romulans have merely made a show of force and protested to the Federation, there's no assurance they'll treat this violation the same way.

As above, the trip to the Neutral Zone takes a total of six days at warp 8 (though many starships can sustain travel at warp 9—see the *ST:TNG RPG*, pages 217–220—thus cutting this time to three days). Captain Rukin uses the time to familiarize the Conn with their course, and the tricks of slipping into the Neutral Zone undetected. Dr. Pilish works with various officers—the First Officer, Doctor, or Counselor—to prepare accommodations for the Arnu (which might bring up a new point of contention—the Crew may be going back solely to pick up Dr. Byron, not to get more Arnu).

Because they travel in a starship, traveling into the Neutral Zone becomes tougher; the Romulans can easily overlook a freighter, but not a starship. Entering Romulan space requires some finesse. Rukin suggests taking a course through the least patrolled section of the Neutral Zone, though this adds another day to the trip. Alternatively, Rukin knows of a stellar phenomenon they can use to their advantage—a cluster of densely packed stars whose radiation and gravitational anomalies obscure sensors, a cepheid variable appropriately timed to vent stellar energy, etc.—but the danger of detection is greater.

If they choose the safer path, the Flight Control officer should attempt a Moderate (8) Ship Systems (Flight Control) Skill Test; add another day to the travel time. If they attempt the more dangerous path, increase the difficulty of this roll to Challenging, or even Difficult (depending on the nature of the stellar phenomenon used to obscure their passage); make a Challenging (11) Shipboard Systems (Sensors) test on behalf of the Romulans (using Intellect 2, rolling 3 dice). If successful, the Romulans detect the ship despite the obscuring circumstances. The Romulans could chalk it up to faulty sensor readings (but alert warbirds in the region), or send a ship to investigate—Narrator's choice.

In both cases, the Narrator should add 7 to the test result and note the total. This is the total number of hours the Crew has to get Dr. Byron before the Romulans arrive.

Once again, as soon as the starship enters the Neutral Zone, the mood on the bridge becomes tense. Does their course take them through lightly patrolled territory? Will the fluctuating energy from the cepheid variable obscure their passage?

Rukin, no longer on his own command deck, seems more than a little jumpy. The Crew might continuously check the sensors, looking for the least sign of company. The trip to the Kir system (a total of four light years) takes an additional 38 hours at warp 8 (or two and a half days if they took the safer route).

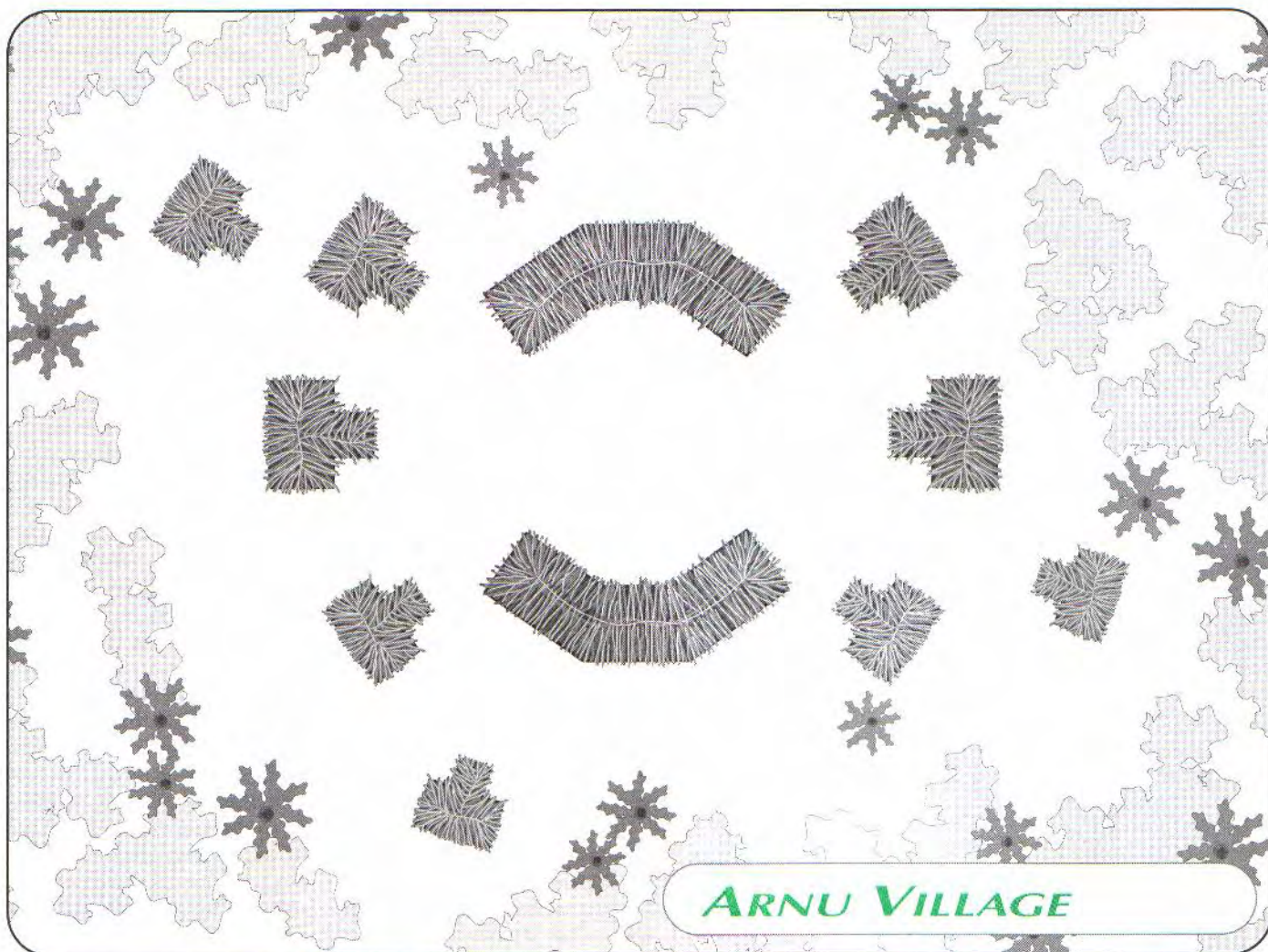

ACT FOUR: AT KIR I

When either vessel arrives at Kir I, the clock begins ticking; the Narrator should begin marking off the hours they have until a Romulan warbird shows up. Trouble starts immediately after the ship establishes a standard orbit around Kir I, when Rukin attempts to contact Dr. Byron. Instead of returning a standard hail, she sends a very short, garbled reply. A Moderate (8) Starship Systems (Communications) Test shows Dr. Byron's response is a coded, short-burst transmission.

According to Rukin, this is a prearranged code set up by Dr. Byron in case of trouble. A PC must make a Moderate (8) Starship Systems (Communications) Test to locate Dr. Byron from her transmission; alternatively, a Moderate (8) Starship Systems (Sensors) Test locates Dr. Byron's life signs. The sensors also identify three small groups of Romulans close to Dr. Byron's position. The Crew can beam down to the surface to rescue her.

Beaming down to the surface, to the coordinates of Dr. Byron's message, they materialize on the damp, swampy world of Kir I. The sky is overcast with low, dark clouds, and there are heavy

downpours. The ground is slippery, making running difficult.

They stand on the edge of an Arnu village, a collection of grass huts standing on stilts. It appears abandoned. Using their tricorders and making a Moderate (8) Personal Equipment (Tricorder) Test, the team locates Dr. Byron inside the village, as well as approximately thirty Arnu. Biological scans also identify a group of five Romulans off to the west.

Calling for Dr. Byron, she emerges from one of the huts. Although dirty and bedraggled, she still looks quite pretty. She's armed with a type II phas-

THE KIR SYSTEM

System Name: Kir

Affiliation: Romulan

System Type: M5 V

Inhabited Planets: None

Other Planets: Kir I (Class M), Kir II (Class H), Kir III (Class J)

Other Stellar Objects: None

Artificial Objects: None

er. Other Arnu tentatively come out of hiding, some armed with phaser weapons. With a sigh of relief, Byron lowers her weapon. She expected Captain Rukin, but not Starfleet, and she's not happy about it.

A noted exoanthropologist, Dr. Byron is gracious and friendly in public. She also has a temper, and is stubborn about her principles. Even though she's relieved to see the Crew, even though the Crew came to save her, she makes it hard on them by making pointed comments and holding them to high standards.

Dr. Byron is unwilling to leave unless the Crew help her sedate and transport this last group of Arnu. They are the last remaining members of this tribe, numbering a total of thirty. If it hasn't come up before (or even if it has, but remains unresolved), the Crew must reach a consensus on saving the Arnu. Remind them, however, of the time constraints if they start to go off on tangents. Dr. Byron is in a hurry to get things moving, as Romulans have been spotted in the area.

If the Crew agrees to help Dr. Byron transport the remainder of her group, she asks for their help in sedating the Arnu. Teaching them about other planets and phasers is one thing; getting them to accept transporting and space travel is quite another.

Byron shows anyone possessing Medical Sciences (General Medicine) skill how to sedate the Arnu. One Crew member can sedate one Arnu per minute. The more people attending to the Arnu, the faster this goes. The process is complicated by the Arnu themselves. It takes time to convince the Arnu to let the Crew sedate them (an Opposed Persuasion, Psychology, or Presence Test). Beaming them up to the ship takes a matter of minutes.

To increase the dramatic effect, the Narrator might have the nearby Romulan squad approach while the Crew prepare the Arnu. This results in a firefight, and the eventual arrival of more Romulan soldiers. (This is a good idea if it looks as though the Crew will complete its task before their time runs out, either to slow them down or to provide an appropriate climax to the story). Use the standard Romulan Template, but give the soldiers Energy Weapon (Disruptor) 2 (3).

If the Crew complete the mission and leave before their allotted time expires, they can leave the system and reach Federation space undetected.

VIGILANCE

If the Crew is unable to complete the mission in the time allotted, the *D'deridex*-class warbird *Vigilance* arrives in system. Commanded by Centurion Malvec, the *Vigilance* patrols the sector regularly. It is only by happenstance that it arrives at this time (or not; the outpost on the border may have alerted him to the presence of an intruding ship).

Malvec knows of Captain Rukin's visits to the Kir system, though he believes the merchant uses the planet as a transfer point for smuggling goods into Federation space. All this will end, he believes, when Kir I is brought into the Romulan sphere. In fact, a legion of Romulan soldiers are in the process of subduing the native population—something that makes Malvec proud.

If, upon his arrival, Malvec finds the *Purveyor* in orbit, he decloaks his ship and contacts the merchant. Malvec wants to intimidate the human trader. He asks a variety of probing questions, wanting to know Rukin's cargo, destination, etc. Narrators should try to draw this out as long as they can, to try to provoke the PC's into doing something foolish (though not too long; players don't like to hear Narrators talking to themselves).

Should the Crew say or do anything to arouse his suspicions, Malvec demands to search the *Purveyor*. If nothing happens that makes Malvec suspicious, he'll accept Rukin's answers to his questions and allow the *Purveyor* to complete its business. Once the *Purveyor* leaves the system, Malvec makes sure the *Purveyor's* return course is set for Federation space, and that they are watched until they leave Romulan space.

Imagine his surprise and delight if instead he finds a Starfleet vessel over Kir I. Malvec suddenly decloaks his warbird and powers up its weapons. He contacts the starship and imperiously orders it to stand down: Everyone on board the vessel is now a prisoner of the Romulan Empire. This is obviously the worst possible conclusion to the episode, and the one fraught with the most peril for the Crew (and Narrator). Not only have they failed to retrieve Dr. Byron and return to Federation space, they've been caught violating the Treaty of Algeron. The Narrator has a number of options available to resolve the tense situation.

The Crew could attempt to battle the *Vigilance*, in the hopes of damaging it and escaping. The Narrator should referee the battle, perhaps fudging things in the Crew's favor. The Crew might devise a unique resolution, perhaps using the Picard Maneuver to get Malvec to surrender. Or they might simply run for the Neutral Zone as quickly as they can, and hope to outrun the *Vigilance*.

The Crew might respond to Malvec's demands by explaining their presence in Romulan space as an accident. A sudden spatial anomaly hurled them into Romulan space, for example. Or a warp drive malfunction caused them to warp uncontrollably into Romulan space. Whether or not Malvec believes their story should depend on roleplaying, though an Opposed Persuasion Test might be appropriate. If Malvec believes their story, he accompanies the starship to the Neutral Zone, and allows the Crew to return to Federation



space. Naturally, he files a report with the Star Command, and the Romulans file an official protest with the Federation.

If the Crew simply surrenders, they've handed the Romulans a diplomatic coup. Their fate now resides in the hands of the diplomats. The Federation negotiates for the Crew's release, then tries them for violating the Treaty of Algeron and the Prime Directive. While this may seem a harsh solution (and the Narrator is encouraged to prevent this from happening), the Crew must face the consequences of their decisions.

The Narrator holds one final trump for the situation: Malvec could simply remain cloaked, watch the starship, and call for reinforcements. When the starship leaves Kir I, he alerts other warbirds in the area. Of course, these additional warbirds are unable to cut the starship off in time, and the Crew's vessel outruns them and returns safely to Federation space.

RESOLUTION

- If the Crew actually arrest Captain Rukin, give them 1 Experience Point and 3 Discipline Renown. Arresting Dr. Pilish gives them an additional 1 Experience Point and another 2 Discipline Renown. Arresting Dr. Byron gives them 1 Experience Points and 5 Discipline Renown. (That's a total of 10 Discipline Renown, for halting a major violation of the Prime Directive).

ARNU TEMPLATE

Attributes

Fitness 2 [4]
 Coordination 3 [6]
 Dexterity +1
 Intellect 2 [5]
 Perception +1
 Presence 2 [5]
 Psi 0 [3]

Skills

Artistic Expression (choose Specialization) 2 (3)
 Culture (Arnu) 2 (3)
 Dodge 2
 History (Arnu) 1 (2)
 Language
 Arnu 2
 Primitive Weaponry (Club) 1 (2)



- If the Crew join Dr. Byron *et al.*, then arrest them, do not give them any Renown award.
- Getting Dr. Byron and the remaining Arnu back from Kir without being detected by the Romulans in either ship is worth 2 Experience Points and no Renown. When Starfleet finds out (and they will, eventually, from the logs), give players -5 Discipline Renown.
- If the Romulans catch either ship at Kir I, subtract 1 Experience Point from the total. If the Romulans catch the starship at Kir I, give the players -10 Discipline Renown. In addition, the Captain and Crew will have some explaining to do to Starfleet Command.

Narrators should give additional Experience Points and Renown to those characters that contributed to formulating the various plans. Players who roleplayed their characters well also deserve additional points.



STAR TREK
THE NEXT GENERATION

the way of d'era

THE ROMULAN STAR EMPIRE

AN ANCIENT SCHISM
A LEGENDARY EXODUS
AN EMPIRE BORN OF STRIFE

They are the hidden enemy, the foe who is both unknown and unknowable. They are by turns hostile and peaceful, aggressive and guarded. They are a people given to violent passions, a culture for whom glory is life. They are the Romulans.

A vast region of space, the Romulan Star Empire encompasses sectors in both the Alpha and Beta Quadrants. The Empire's long, storied, and often brutal history remains largely hidden from most outsiders. Life within the Empire is governed by the Way of D'era, a harsh and militaristic philosophy that pre-dates the time of the Empire's founding and guides the Empire in its expansion throughout the galaxy. It is a way of honor, a way of cunning, a way of Empire.

The Way of D'era: The Romulan Star Empire gives players and narrators alike a detailed overview of this vast interstellar empire. Within its three books you will find comprehensive discussions of everything from Imperial history and politics to Romulan religion and culture. Other sections include treatments on the Romulan economy and mercantile relations, the Imperial and senatorial fleets, worlds and client states. Romulan technology and vessels, and important personalities of the Star Empire. New ships and new templates abound. From the *Tal Shiar* to the homeworlds of Romulus and Remus, all the way back to the schism on ancient Vulcan—*The Way of D'era: The Romulan Star Empire* has it all for fans of the most secretive race in the *Star Trek*® universe. Make no mistake—you're not in the Federation anymore... Are you prepared to follow the Way of D'era?



BOOK I: THE ROMULANS INCLUDES:

- ▼ Detailed treatments on Romulan history and politics.
- ▼ An overview of the Imperial government, with information on the Senate, the Praetor, and the Continuing Committee.
- ▼ Extensive sections on the Romulan Star Navy, including its organization, its various branches, and its role in Romulan society.
- ▼ An in-depth look at Romulan space, from the core worlds to the Empty Frontier to the disputed territories along the rimward border with the Taurhai Unity.
- ▼ New ships, technology, alien species, creatures, worlds, and more!

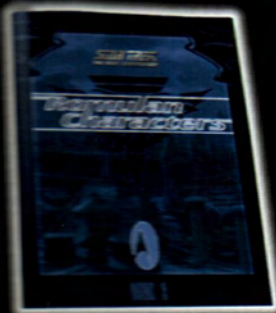

BOOK II: ROMULAN CHARACTERS INCLUDES:

- ▼ A brand new system for creating Romulan characters, including Glory, a trait reserved for Romulans alone.
- ▼ New skills, traits, templates, and overlays—everything you need to create unique and vibrant Romulan characters and crew.
- ▼ Detailed information on designing and running Romulan series, using Romulan characters within the bounds of the Star Empire—this book essentially gives you an entire Romulan roleplaying game!

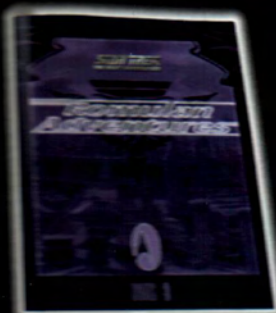

BOOK III: ROMULAN ADVENTURES INCLUDES:

- ▼ *The Gentara Incident*: On the Romulan protectorate of Gentara, the natives chafe at the yoke of Romulan dominion and secretly plot rebellion. Can you stop the revolt, and uncover the web of intrigue that lies just below the surface?
- ▼ *Duty or Conscience*: A simple investigation on a small mining colony leads a Crew of Starfleet officers to uncover a violation of the Prime Directive. Your reaction could determine the fate of relations with the Romulan Empire.



ISBN 1-889533-08-4



9 781889 533087 >

STAR TREK™, ® & ©1999 Paramount Pictures. All Rights Reserved. STAR TREK and Related Marks are Trademarks of Paramount Pictures. LAST UNICORN GAMES, Inc. Authorized User. ©1999 Last Unicorn Games.