

The Electrical Experimenter



NOV.
1915
10 CTS.

★

THE RADIUM DESTROYER

See page 315.

TRADE
ELECTROSE
MARK.
REG. U.S. PAT. OFF. & FOREIGN COUNTRIES.
INSULATION

INSULATORS 1,000 TO 1,000,000 VOLTS
Employed by **U. S. NAVY**
and all the Commercial Wireless
Telegraph Companies
LOUIS STEINBERGER'S PATENTS

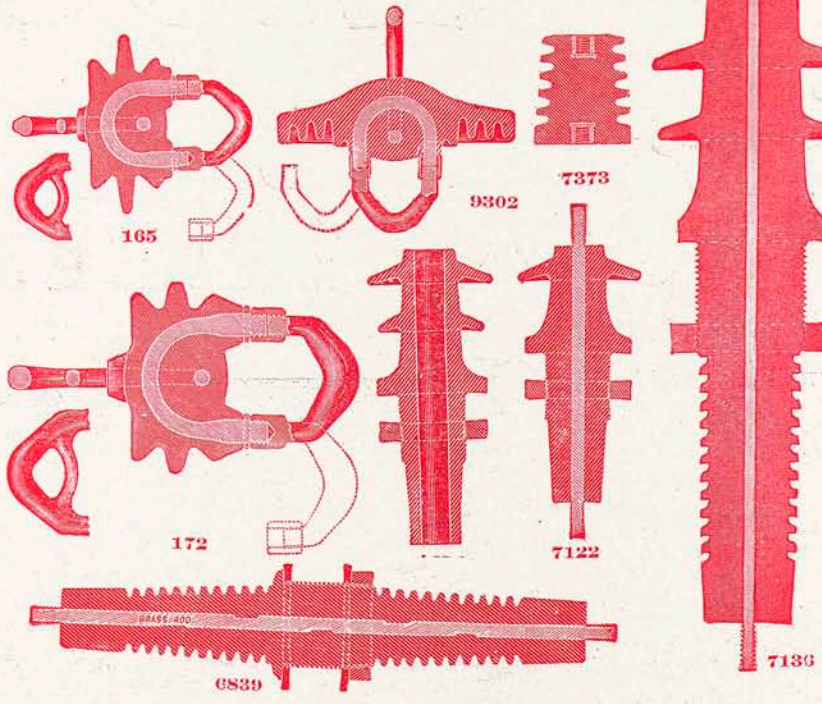
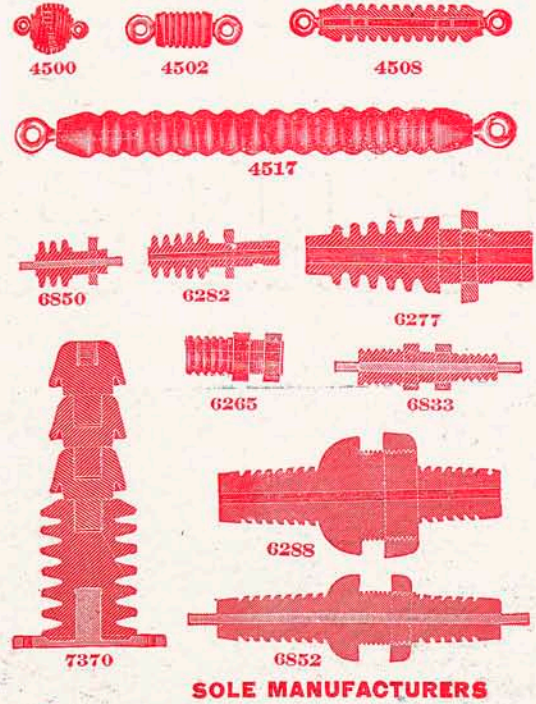

SOLE MANUFACTURERS

ELECTROSE MFG. CO.

66-76 Front St.
60-72 Washington St.

BROOKLYN, N. Y.
AMERICA

Are You Losing the Weak Signals?

ARE the receivers you use merely high-wound telephone receivers, — which bring in ordinary signals clearly enough, but miss altogether the weak, long-distance ones?

Or are they real wireless receivers — sensitive enough to bring in even the extremely weak signals?

Until you have actually tried Brandes Receivers, you will never know how many signals you may now be failing to receive because of inefficient receivers.

They are designed, made and used solely as wireless receivers. They have Sensitiveness which is surprising — Tone which is absolutely uniform — Lightness which permits their use for hours without causing fatigue. Comparison with any other make will prove these points of superiority to you.



The "Superior" Set, Price, complete, \$5.00

To-day—write for our new CATALOG E, containing important information about radio receivers, as well as full information about our several types of Head Sets. Enclose 2c. stamp.

C. BRANDES
Wireless Receiver Specialists
Room 814
32 Union Square, New York, N. Y.

Brandes Wireless Head Sets

HERE IT IS

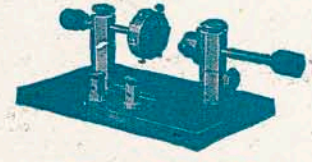

**The ALBANY
Combination DETECTOR**

Polished hard rubber base, 1/2 inch hex. brass standards, one pivoted.

Five holes in large cup. Small cup 5/8 inch diameter. Noval cat whisker attachment with each instrument.

PRICES

Lacquered brass \$2.00
Polished nickel 2.50
Postage extra—weight 1 lb.

We are still selling our
No. 102 Condenser for \$2.50
Postage extra. Weight 2 lbs.
Order yours to-day, as this offer will not last long.

Send for our circular 3-G.

MAGUIRE & SHOTTON
814 LANCASTER ST.
ALBANY, N. Y.

You benefit by mentioning "The Electrical Experimenter" when writing to advertisers.

DUCK'S No. 9—325-PAGE
Electrical and Wireless Catalog

Ready on October 20th

40 more pages of wireless instruments at more attractive prices than ever.

Also many new items in electrical supplies at substantial reductions in price.

What This Big Catalog Contains

- 160 pp. Wireless Apparatus for Commercial and Experimental use.
- 10 pp. Raw Material,
- 5 pp. Transformers,
- 8 pp. Storage Batteries
- 15 pp. Telegraph Insts.,
- 42 pp. Motors and Dynamos,
- 10 pp. Miniature Lamps,
- 8 pp. Flashlights,
- 5 pp. Massage Vibrators,
- 10 pp. Miniature Railways,
- 5 pp. Lighting Plants,
- 10 pp. Ammeters and Voltmeters,
- 25 pp. Electrical and Mechanical Books,
- 12 pp. Telephone Equipment,
- 10 pp. Auto Accessories,
- 13 pp. Victrolas, on our Easy Payment Purchase Plan (No Down Payment),
- 30 pp. General Electrical Supplies.

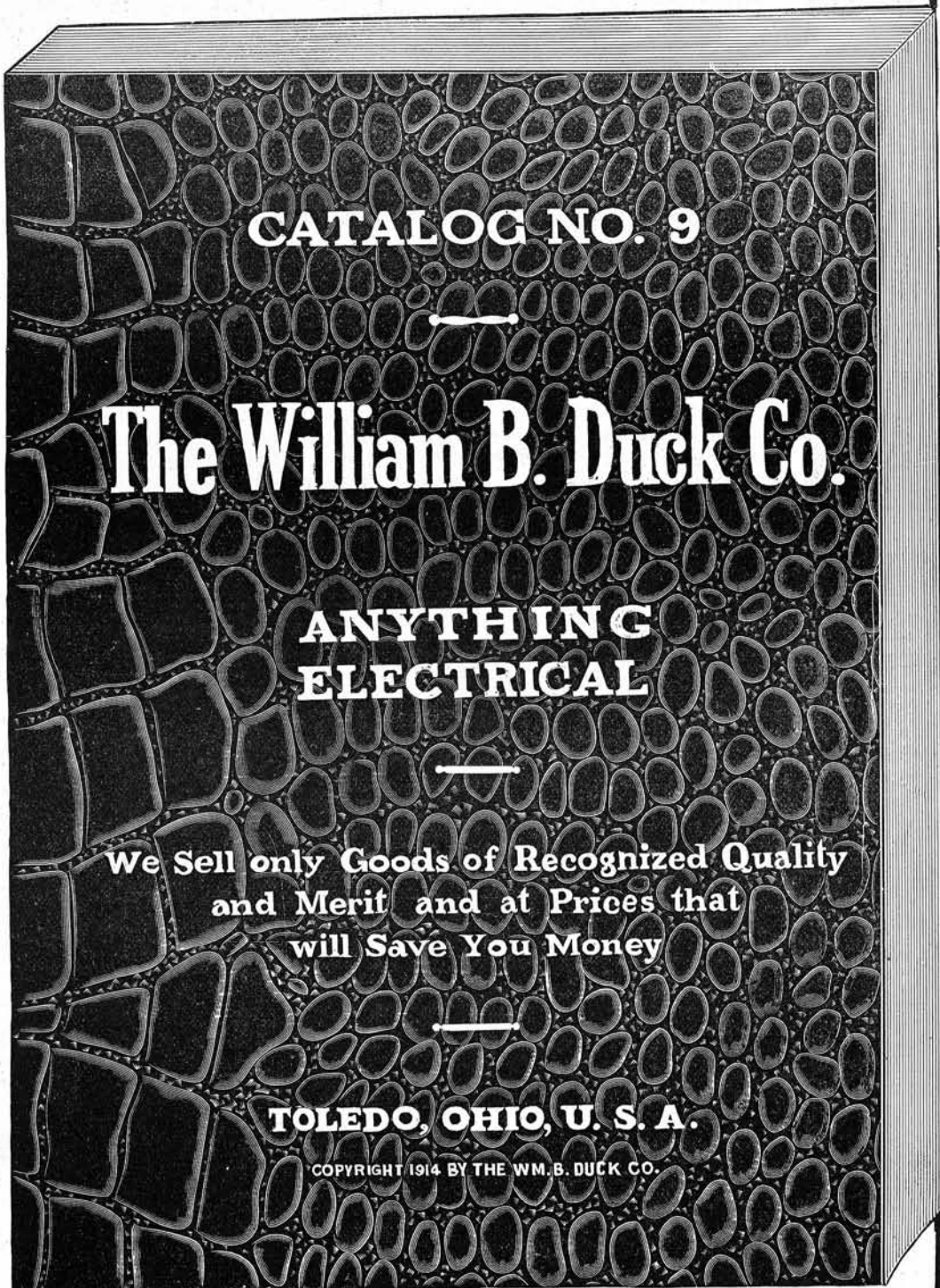

THIS UNRIVALED CATALOG MAILED TO ANYONE UPON RECEIPT OF 8 CTS. IN STAMPS or coin, which may be deducted on first dollar purchase. Great cost of catalog and low prices prohibit distribution otherwise.

THE WILLIAM B. DUCK CO., 230-232 Superior Street
 TOLEDO, OHIO

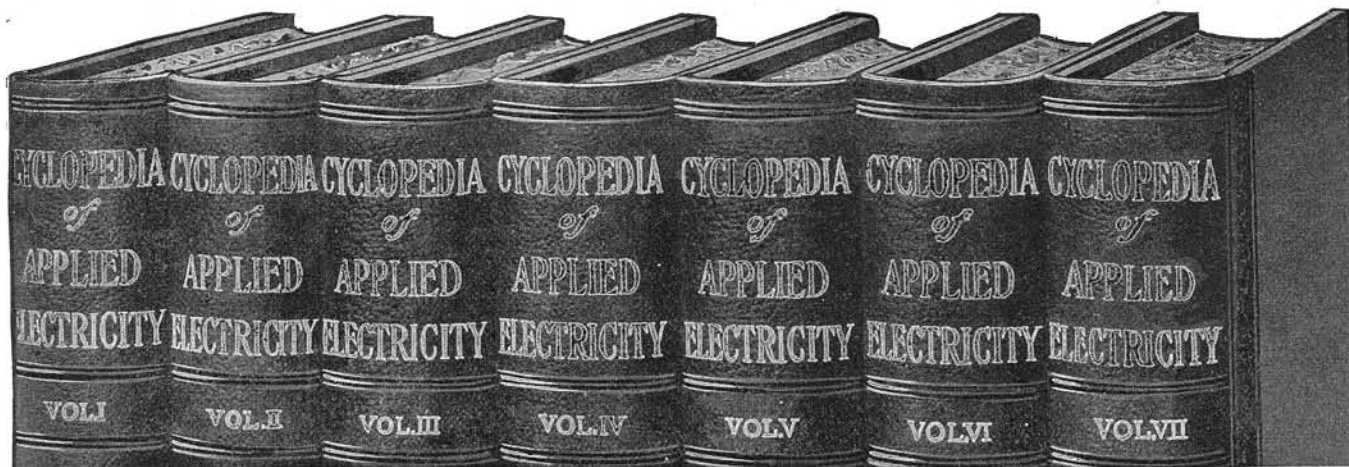

World's Greatest Electrical Library SENT FREE FOR EXAMINATION

Send the coupon today—*now*—for your free-for-examination set of the world's greatest electrical library. The new 1915 edition, just off the press, is recognized by big men in the electrical field as the most practical work of its kind ever published. Covers completely the generation and use of electricity for power, light, transportation and communication, including the construction and operation of dynamos and motors, central station engineering and telephone work, as well as *wireless telegraphy and telephony* and land and submarine telegraphy. Particularly helpful in its exhaustive treatment of electrical "troubles" and their remedies.

Earn \$150 to \$250 a month Electrical Engineers earn from \$150 to \$250 a month. The work is pleasant—the hours short. These great books will fit you, in your spare time, to enter this fascinating, well-paid work. No previous experience necessary.

Cyclopedia of Applied Electricity

New 1915 edition contains 3,500 pages, 7x10 inches; 3,000 illustrations, full page plates, diagrams, etc.; hundreds of valuable tables and formulas; carefully cross-indexed for quick, easy reference. The books are substantially bound in half red morocco, gold stamped, and are printed in large, clear type on special quality paper.

50c a week Upon receipt of the coupon below the complete seven volumes, not a sample volume, will be sent, express prepaid, for seven days' free examination; returnable at our expense if they fail to meet with your expectations. If you keep them, pay \$2 seven days after receipt and then \$2 a month—50c. a week—until you have paid the special introductory price of \$19.80, saving \$15.20, as the regular price of this new and enlarged edition is \$35.00. As this offer is for immediate acceptance only, fill in and mail the coupon to-day. It won't cost you a cent to examine these books, so get them into your home, shop or office and look them over at your leisure. Remember, if you don't like them they may be returned at our expense and you won't be out a penny. One of the most liberal offers ever made. You can't afford to pass it by.

What These Books Cover

Elements of Electricity—Electrical Measurements — Underwriter's Electrical Requirements — Theory, Calculation, Design and Construction of Direct Current Generators and Motors—Types of Generators and Motors—Management of Electrical Machinery—Electric Lighting — Alternating Current Machinery—Power Transmission—Electric Railways — Self-Propelled Railway Cars—Trackless Trolleys—Power Stations—Switchboards and Switching—Storage Batteries — Applied Electro-chemistry — Electric Elevators—Electric Welding and Heating—Wireless Telegraphy and Telephony—Land and Submarine Telegraphy.

This Coupon Worth \$15.20 to You

American Technical Society, Chicago, U. S. A.

Please send me Cyclopedia of Applied Electricity for seven days' examination. If I keep the books, will send \$2 within seven days and \$2 a month until \$19.80 has been paid, when \$35 books and \$12 consulting membership will be mine. Otherwise will notify you and hold books subject to your order. Title not to pass until fully paid.

Elec. Exper. 11-15.

NAME

ADDRESS

As I have had no previous dealings with you, I refer you to

Consulting Service Free

With every set is included absolutely free a year's Consulting Membership, regular value \$12, entitling you to the advice of a staff of electrical experts. These men are no further from you than your nearest mail box. They stand ready to solve your perplexing problems, to offer suggestions, to point out the things you should avoid. Absolutely no limit to their assistance—ask as many questions as you wish for a whole year. This service alone will be worth more to you than the entire cost of the books.

Don't wait. This means \$15.20 saved if you act now. Remember, you take no chances whatever—it costs nothing to inspect and you are nothing out if you do not care to buy. This offer may mean your success, so mail the coupon to-day—*now*—before you turn the page.

American Technical Society, Chicago, U. S. A.

The Electrical Experimenter

Published by Experimenter Publishing Company, Inc. (H. Gernsback, President; S. Gernsback, Treasurer; M. Hymes, Secretary), 233 Fulton St., New York

Vol. III Whole No. 31

CONTENTS FOR NOVEMBER, 1915

No. 7

FRONT COVER—"THE RADIUM DESTROYER".....	—	ILLUMINATED STEAM CURTAIN GIVES WONDERFUL EFFECT AT NIGHT.....	332
From a Painting by Thomas H. Wrenn		ELECTRICITY AND THE TWENTIETH CENTURY DENTIST..	332
THE ELECTRO-MAGNETIC GUN AND ITS POSSIBILITIES... 309		"THE CONSTRUCTOR" DEPARTMENT	333
BARON MUNCHHAUSEN'S NEW SCIENTIFIC ADVENTURES.	By Hugo Gernsback	HOW TO BUILD A DICTAPHONE DESK SET.....	333
WARFARE OF THE FUTURE.....	312	CONSTRUCTION OF AN INDUCTIVE TUNER.....	334-335
WHEN THE LIGHTS WENT OUT ON THE "BELLA".....	315	By Milton B. Sleeper (Conclusion)	334-335
WHAT THE HOUSEWIFE SHOULD KNOW ABOUT ELECTRICITY	316	"RADIO" DEPARTMENT	337
SOMETHING ABOUT SELENIUM.....	318-320	THE AMATEUR RADIO STATION WHICH AIDED UNCLE SAM.....	By Charles E. Apgar 337-338
WIRELESS TELEPHONY NOW FROM WASHINGTON TO HONOLULU	321	A POCKET WIRELESS SET.....	338
PHOTOGRAPHING SOUND WAVES ELECTRICALLY.....	322-323	A MACHINE THAT CAPTURES AND HOLDS WIRELESS TALK	339
DANIELS NAMES NAVAL BOARD.....	323	HOW WIRELESS WAVES TRAVEL AROUND THE EARTH'S CURVATURE	340
SOME NEW X-RAY APPARATUS.....	324	HOW TO BUILD A WAVE METER.....	By Samuel Cohen 341
READING ELECTRIC METERS WITH A CAMERA.....	326	"HOW-TO-MAKE-IT" DEPARTMENT	344
MISHAPS ATTEND USE OF WIRELESS ON AEROPLANES.....	326	"WRINKLES, RECIPES AND FORMULAS".....	Edited by S. Gernsback 347
MASSIVE ELECTRIC GENERATOR HOLDS AUTOMOBILE.....	327	348-349	
MIND-READING DOG IS A PUZZLE TO SCIENTISTS.....	327	"LATEST PATENTS" DIGEST.....	350
HIGH FREQUENCY CURRENTS AND APPARATUS.....	328-329	"PHONE PATENTS"	351
By H. Winfield Secor	328-329	QUESTION BOX.....	352
STEPPING STONES FOR JUNIOR ENGINEERS.....	330	"PATENT ADVICE".....	Edited by H. Gernsback 361
AUTOMATICALLY CONTROLLED ELECTRIC OVEN FOR TESTING SHRAPNEL	331		

New York to Honolulu by Radio Phone

SEPTEMBER 29, 1915 marks another milestone in the history of Wireless. On that date, for the first time, the human voice was projected through free space over the immense distance of 4,900 miles. The new wireless telephone here triumphed over the old wire telephone in an astonishing manner, for up to this time the greatest distance covered by the wire telephone was but 4,750 miles. Nor is the vanquishing of this enormous distance by the Radio Phone the greatest accomplishment of the feat as a whole. For when Mr. Vail at New York on that memorable date hurled his voice through 4,900 miles to Honolulu, where Lloyd Espenschied caught it over his aerial, Mr. Vail was not using the Wireless Phone at all. He spoke into an ordinary desk phone transmitter and his voice was thence relayed by the big Arlington Wireless station. Here, by means of gas valves of the Audion type, the impulses of the voice were "stepped up" till they were finally strong enough to operate the sending apparatus. Thus the feeble voice arriving at Arlington absolutely controlled several hundred horsepower—300 kilowatts to be accurate—and it was this enormous energy that was then radiated out into space for thousands of miles. While we know definitely that during this test the human voice was carried through 4,900 miles of ether, it is quite certain that the impulses were carried much

further than this distance. Indeed, we do not doubt that if we had only the proper receiving apparatus, Mr. Vail's voice could have been clearly heard over twice the covered distance. Indeed we are not at all sure that the waves from the smallest amateur station do not travel all around the world. While this may sound fantastic, let us consider that each succeeding year, as our detectors become more sensitive, less and less power is required for transmitting. With a modern amplifying set, small stations can now be heard over astonishing distances, never dreamt of less than a decade ago.

In this respect we can compare the detector with a telescope. The more we can magnify, the further we are enabled to see, and there seems to be no limit to the distance that can thus be covered. It is precisely the same with a Radio detector; the more sensitive we can make it, the further away will we be able to receive messages from a given station. There seems to be no limit to the distance that can be covered in this manner.

Truly, while this recent feat has been a signal achievement, we confidently look forward to that time—not far off, we think—when it will be possible to talk from New York to Chicago with a power derived from six small dry cells.

H. GERNSBACK.



(Illustration shows container with cover off and battery partly inserted)

MESCOLITE WILL MAKE YOUR WAY SAFE and BRIGHT

in garage, barn, cellar, closet; in camp; on the motor boat; for the dark country road or any other situation where a lantern, lamp or candle is used, besides many places when an open flame would mean fire, explosion and disaster.

The MESCOLITE consists of a japanned metal container with cover, fibre disc with battery contacts, polished metal reflector, clear glass lens, miniature battery lamp, lens cap or rim with three bayonet catches, a non-detachable bail or handle large enough to allow the arm to go through it, and a RED SEAL Dry Battery. The light is strong, bright and steady and absolutely unaffected by weather conditions. For efficiency, economy and serviceability it is unsurpassed by any other battery lantern. Another good feature is that the battery cannot be inserted in the container in any other way than the RIGHT WAY.

The Red Seal Battery will give about twenty-five hours of continuous service and from forty to fifty hours of intermittent service. Always use the RED SEAL Dry Battery in preference to any other. It does not deteriorate when not in use. If the RED SEAL Dry Battery cannot be had any other standard size dry cell can be used.

The MESCOLITE can also be supplied with a "Special" two cell dry battery which will give approximately 60 hours of continuous and 120 hours of intermittent service.

No. 5343—MESCOLITE, complete with RED SEAL Dry Battery 1½-volt lamp.....\$1.50

No. 5344—MESCOLITE, complete with "Special" two cell dry battery.....\$1.75

Send for Our Manual No. 9 on Wireless Telegraphy



You should have it even if only superficially interested. Around about you every day you read of some marvelous occurrence in which wireless played a distinguished part. It may not be entirely clear to you. The Manual will explain it. To the student of Wireless Telegraphy the Manual contains much that is indispensable to a proper understanding of the art. A good portion of this is now published for the first time—and consists of formulas, tables, diagrams, Federal regulations, codes, diagrammatic instruction for installing, maintaining and operating wireless stations, together with a complete list of up-to-date wireless instruments and accessories.

The Manual contains 120 pages, fully illustrated on high-grade paper stock with a two-color cover. We ask ten cents (\$0.10) for it—give you a coupon receipt which can be applied on any order amounting to One Dollar (\$1.00) or more.

Do not wait until some other time, but sit down now and send your name and address, and get one of the most complete, comprehensive and reliable wireless pamphlets published.

Send for Our New Catalog W 28

It is pocket size, 8x4½ inches, contains 248 pages, with over 1,100 illustrations, and describes in plain, clear language all about Bells, Push Buttons, Batteries, Telephone and Telegraph Material, Electric Toys, Burglar and Fire Alarm Contrivances, Electric Call Bells, Electric Alarm Clocks, Medical Batteries, Motor Boat Horns, Electrically Heated Apparatus, Battery Connectors, Switches, Battery Gauges, Wireless Telegraph Instruments, Ignition Supplies, etc.

There exist a thousand and one ways where electrical devices may be used, and to know what is best for your purpose you need this catalog.

IT MEANS MONEY SAVED TO YOU
to have our Manual and our Catalog when you want to buy.

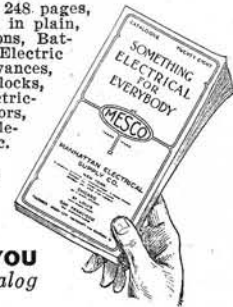

MANHATTAN ELECTRICAL SUPPLY CO.
NEW YORK CHICAGO ST. LOUIS SAN FRANCISCO
17 Park Place 114 S. 5th Ave. 1106 Pine St. 604 Mission St.

FRIENDS—AMERICANS—COUNTRYMEN: LEND US YOUR EARS!!!

CLAPP-EASTHAM CO. has a new catalog in the hands of the printer. It will be ready soon after you read this advertisement. It is brimful of new things we have never shown before, motors, dynamos, meters, parts for building all sorts of electrical things, spark coils, electrical cooking and heating devices, motion picture machines, phonographs, and a thousand other things you will want to see.

☐ It has an appeal for every man, woman, boy or girl. Send for your copy now, to-day, while you think of it.

☐ The holidays are coming soon and you'll surely want it before then. It will easily solve the problem of "what to give" or "what you want."

ITS FREE

☐ Since 1907 our name has been associated only with apparatus which carries a feeling of pride and security attaching only to material "a little better than the best."

CLAPP-EASTHAM CO. MANUFACTURERS AND DISTRIBUTORS
141 MAIN STREET : : : : CAMBRIDGE, MASS.



THE ELECTRICAL EXPERIMENTER

H. GERNSBACK EDITOR
H. W. SECOR ASSOCIATE EDITOR

Vol. III. Whole No. 31

NOVEMBER, 1915

Number 7

The Electro-Magnetic Gun and Its Possibilities

WHILE we have heard of many different kinds of life destroying guns and other weapons during the present European conflict in all its magnitude, there are probably not many of us who have stopped to think of the possibilities of a somewhat unknown invention which relates to nothing less than the hurtling of large projectiles through space by means of electro-magnetism properly applied to a gun or cannon barrel.

There have been several patents issued on such devices, but to our knowledge none of these have been adopted by any of the world powers. As an introductory explanation reference may be made in this connection to Fig. 1, and undoubtedly the reader will then be able to grasp, with the aid of the following explanatory remarks, about how the various inventors of the electro-magnetic guns intend hurling their projectiles at the enemy with hair-raising rapidity and accuracy.

Referring to Fig. 1, and for the sake of simplicity, we may consider that but three electro-magnetic coils are in use as at 1, 2 and 3 along the gun barrel. It may be said that invariably such a gun barrel should have an inner lining of brass or bronze, so that the projectile which is usually made of a magnetic material (such as iron or steel), will not bind within the barrel. The barrel proper can be made of iron properly divided, but an all-brass barrel is common. Now consider that the three magnet coils, 1, 2 and 3, are connected up to a switch as shown. If, then, an iron projectile is placed in the position A, and the current caused to flow through the coil 1, the electro-magnetic field of force set up within the gun barrel will tend to pull the projectile forward in the direction of the arrow. It should be mentioned before going further that the iron barrel (if used) of the cannon or gun is divided up into several distinct sections so as to localize and intensify the magnetic pull on the projectile at each new impulse.

Of course, this scheme outlined at Fig. 1 is only mentioned to bring out the general theory of how these guns are supposed to operate. To continue: when the projectile has reached the position of coil 1 the control switch is moved so as to cut out coil 1 and to connect coil 2 into circuit. If this is done quickly the projectile will have been sucked forward on a line with coil 2. The operation is again repeated

and the switch is moved so that coil 3 will be put into the circuit and coils 1 and 2 opened. Thus the projectile will again be pulled forward to section 3, and at the instant it reaches the center of the *final coil* the current is cut off and the momentum acquired by the projectile is relied upon to carry it on and out of the muzzle of the gun at B. This design is the basis of most of the patents on this unique device, which has yet, we may say, to be proven in a practical sense for modern warfare requirements, although it seems indeed to possess possibilities if the details are properly worked out.

The wash drawing illustration here presented at Fig. 2 shows how we may conduct warfare in the future if the powers that be still think that the only way to settle an argument is by main strength and ignorance. In our illustration is shown a probable development of a large electro-magnetic field gun mounted on a massive iron frame-work fitted with large caterpillar wheels, as observed, so that it is mobile enough to be quickly hauled from one place to another on the battlefield or for siege purposes. When used for portable requirements it will invariably be necessary, if such guns are ever adopted, to provide a complete portable electric generating plant as is shown in the picture. This would comprise a powerful gasoline engine direct connected to a suitable electric dynamo.

Some idea of the probable size of such guns may be obtained when it is stated that one of the best designs ever worked out on this principle, and due to Prof. Birke-land, has a barrel 90 feet in length. The projectiles used in this gun would be about 9 feet long and have a diameter of 19 inches. Also to gain the maximum magnetic pull by this arrangement it is recommended that the projectile be wound with coils of wire so as to be electro-magnetically reactive in conjunction with the regular magnetic disc coils placed along the barrel of the gun as perceived. In order to facilitate the passage of the projectile through the barrel of the gun with the least friction we strongly suggest that suitable lubrication be provided by means of grease or oil cups placed along the barrel at intervals; these may be observed in our illustration Fig. 2.

It must be remembered that these guns would not heat to any appreciable extent

and not at all compared to the heat produced in the modern high powered guns using explosive charges of powder. Due to this and other obvious reasons such a gun as this can fire a great number of larger caliber shells per minute, possibly fifty to seventy-five shells in one minute. It will be seen from the foregoing that such a discharge of 19-inch shells, each of which contains a very high explosive powder charge, would serve to quickly rout the enemy, no matter how well he might be entrenched or ensconced behind fortified embankments. A rain of such monster shells would batter down almost any fortification whether natural or built by man. A method is suggested in the illustration of this electro-magnetic gun of the future whereby a constant supply of shells for rapid firing can be always maintained before the open breach of the gun. The shells might be hoisted by means of a gasoline engine and run on the platform at the left and then allowed to slide by gravity down the inclined chute. As fast as one of the shells is sucked into the breach of the gun barrel it is followed by another one right after it successively. It is easily possible to have means of firing the shells as far apart, in respect to time, as is deemed advisable, of course. The electric current supplied through the coils along the gun barrel can be controlled through a suitable switch by the man aiming the gun and who may be located alongside of the breach of same as perceived in our illustration.

Such guns as these firing 19-inch explosive shells may have a range of twenty-five miles or more. The shells may carry time fuses, or they may be of the concussive explosion type, whereby they do not explode or burst until they hit the ground or the wall of a fort, etc.

Of course, these magnetic guns are practically noiseless and naturally also absolutely smokeless. Furthermore the wear and tear or depreciation, in so far as the gun barrel lining is concerned, is very low compared with modern cannon and other arms using explosive charges to expel the bullet or shell from the barrel of same. The shells or bullets in such cases must fit very tightly so as to prevent the exploding charge in the gun barrel from leaking out and at the same time to force the shell outward with all available power. In magnetic cannon the shell does not

THE ELECTRICAL EXPERIMENTER is published on the 15th of each month at 233 Fulton Street, New York. There are 12 numbers per year. The subscription price is \$1.00 a year in U. S. and possessions. Canada and foreign countries, \$1.50 a year. U. S. coin as well as U. S. stamps accepted (no foreign coins or stamps). Single copies, 10 cents each. A sample copy will be sent gratis on request. Checks and money orders should be drawn to order of **THE EXPERIMENTER PUBLISHING CO. INC.** If you change your address notify us promptly, in order that copies are not miscarried or lost. **A green wrapper indicates expiration.**

All communications and contributions to this journal should be

addressed to: Editor, **THE ELECTRICAL EXPERIMENTER**, 233 Fulton Street, New York. Unaccepted contributions cannot be returned unless full return postage has been included. ALL accepted contributions are paid for on publication. A special rate is paid for novel experiments; good photographs accompanying them are highly desirable.

THE ELECTRICAL EXPERIMENTER, Monthly. Entered as second-class matter at the New York Post Office, March 1, 1915, under Act of Congress of March 3, 1879. Title registered U. S. Patent Office. Copyright, 1915, by E. P. Co., Inc., New York. **The contents of this magazine are copyrighted and must not be reproduced without giving full credit to the publication.**

necessarily have to fit the barrel tightly and thus friction can be vastly reduced. Moreover, there is no pitting or other wear on the inside of the barrel, due to powder explosions as just mentioned.

At Fig. 3 is shown a patent issued to S. T. Foster, Jr., (No. 811,913) on an electro-magnetic gun. This patent will serve to give a fair idea as to the general make-up of these devices intended to supplant the modern artillery now in use by world powers. Mr. Foster arranges a series of powerful electro-magnetic coil windings along the non-magnetic gun barrel 11-12. The magnetic projectile made of iron or steel is placed in the breach at 11, just far enough to reach the electric contact 1. When this contact is depressed by the shell it closes the electric circuit through the magnetic coil 15. This causes the shell to be pulled forward, and as the forward section of the projectile then engages the cut-out switch 2, it depresses same and excites the magnet coil 16. The projectile is then pulled forward electro-magnetically until it is in line with coil 16, and simultaneously actuates the cut-out switch 1, which opens the circuit to coil 15. At this instant, generally speaking, the shell in sliding forward into line with coil 16 has engaged the cut-out switch No. 3 and this closes the coil circuit 17, thus the shell is pulled forward into line with that coil and coil 16 is cut out of circuit, owing to the contact 2 having reset itself automatically.

Thus it will be seen how the iron projectile is propagated through the barrel toward the muzzle 12. The operation previously described repeats itself until the shell reaches the position of coil 23, and here it strikes a cut-out switch 10, which opens the current circuit. No magnetic pull is further exerted on the projectile and it leaves the muzzle of the gun under its own momentum. The inventor in this case claims that the shell is supposed to gain velocity repeatedly and successively as it moves from each coil to the succeeding coil. This arrangement for cutting out the coils as the shell moves through the barrel is followed out in several other patents and seems to be a general idea with most of the inventions in this direction.

It would take up too much space here to describe in detail the very ingenious mathematical and engineering deductions cited in the wonderful patent of Prof. Kristian Birkeland of Sweden. In his patent (U. S. Patent No. 754,637) he brings out some very fine points with regard to the development of the electro-magnetic gun. A few of the considerations there advocated,

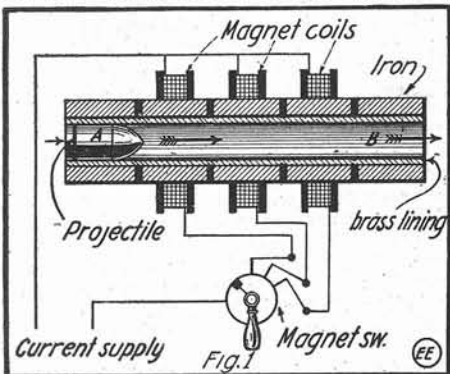

Fig. 1. Elementary Diagram Showing Action of an Electro-magnetic Gun.

hypothetically and otherwise, are outlined below.

In the first place, it has been found difficult to make an electro-magnetic gun of ordinary size which will exert a sufficient pull on the projectile to gain the effects

now produced by the modern explosive charge type of cannon. Therefore this inventor proposes to arrange the switches, etc., on his gun so that the current through the coils will only be left on for a very small fraction of a second in any case. Also in considering the regular approved engineering design of such magnetic coils

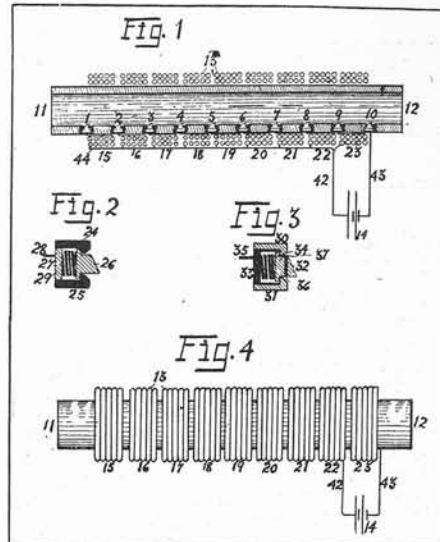

Fig. 3. Electro-magnetic Gun Patent Issued to S. T. Foster, Jr.

he proposes not only to pass a normal current through the coil, but a current even ten times as heavy, or more, and thereby momentarily (for the fraction of a second), a terrific magnetic pull can be exerted on the iron shell within the barrel. He mentions further (and this is a capital idea) in order to increase the magnetic action in such a gun it is preferable to make the projectile of iron surrounded by magnetic coils instead of iron alone.

Further schemes outlined in Prof. Birkeland's patent cover the arrangement whereby it is possible to open the magnetic coil circuit without any spark occurring at the break of the contacts. This is accomplished by taking advantage of the fact that the projectile moving through the barrel will induce electric currents in the magnet coils and at the instant when this induced current is approximately equal to the current flowing through the coil and which, of course, passes through the coil in the opposite direction to the normal current, then the cut-out switch is operated with no sparking at same.

He goes on to say: "As to the dimensions which may be given to guns constructed according to my invention, the following example may be mentioned: For throwing an iron projectile weighing two tons and containing one thousand pounds of nitro-gelatin at an initial speed of one thousand feet per second I propose the use of a gun with a length of about ninety feet, the projectile being about nine feet long and having a diameter of about nineteen inches. The gun solenoids may be made up of square wire, each solenoid containing seven hundred and twenty windings of a total resistance of fifteen ohms. The length of each solenoid is made about three-eighths of an inch and the height (radial dimension) about eight inches. With an electromotive force of three thousand volts this will give a current of two hundred amperes. If the current is set up simultaneously in all the solenoids (there will be about three thousand elementary solenoids), this will require altogether six hundred thousand amperes, and the suc-

tion acting on the projectile will be about two thousand five hundred pounds per square inch of the cross-sectional area of the projectile. A calculation shows that when a firing is to take place the current should be set up one-seventh of a second before the firing. The projectile is then set free, and will pass the barrel in the course of one-fifth of a second. The current has then been on the outermost solenoid about one-third of a second. If, however, a construction is used in which all the groups of solenoids are not at once excited less than half the current will be used for the same effect, and the generation of heat in the outermost solenoids will be reduced."

ENGINEERS FORMING RESERVE CORPS.

The movement begun in a tentative way last spring to form a reserve corps of engineers to be available in case of war has assumed definite form, according to announcements made by Bion J. Arnold, of Chicago, chairman of the A. I. E. E. committee of the proposed reserve corps of engineers.

Some time ago the suggestion was taken up by the American Society of Civil Engineers, the American Institute of Mining Engineers, the American Society of Mechanical Engineers, the American Institute of Electrical Engineers and the American Institute of Consulting Engineers. Each of these organizations appointed committees to further the movement, which has now become more closely consolidated by the appointment, just announced, of the chairman of various committees as members of a joint committee to take charge of the work in co-operation with the War Department. The members of the committee are as follows: William Barclay Parsons, New York, chairman, and Henry S. Drinker, Pennsylvania; William H. Wiley, New York; B. J. Arnold, Illinois, and Ralph D. Mershon, New York.

INCREASING WIRELESS RANGE BY KITES.

The recent manoeuvres in northeastern Massachusetts were of particular interest because of successful experiments by the Signal Corps in maintaining a wireless aerial at a great altitude by means of kites, and thereby increasing the efficiency of an ordinary field radio set from six to sixteen times. At the invitation of Adjutant-General Cole of the Massachusetts Volunteer Militia, Samuel F. Perkins, a maker and flyer of man-lifting kites, went to Newbury and experimented with the Signal Corps. As there happened to be fairly strong winds at the time, Mr. Perkins was able to send up a string of kites to a height of 1,600 feet. The messages transmitted from the kite-supported aerial are said to have been received 150 miles away with distinctness, although the field wireless set used would only transmit messages 25 miles ordinarily. The results were obtained because the kites flew so steadily that the aerial was always maintained at a constant altitude. The receiving qualities of the kite-supported aerial were remarkable. Messages were received from the battleship Georgia, off Newport, and from the Government stations at Arlington, Va., and Bermuda. Code messages being exchanged between two British warships out in the Atlantic Ocean were received with accuracy. Further experiments by the United States Government and Marconi officials are now being conducted, and it is expected that in a short time the range of sending from an ordinary field wireless set will be increased.

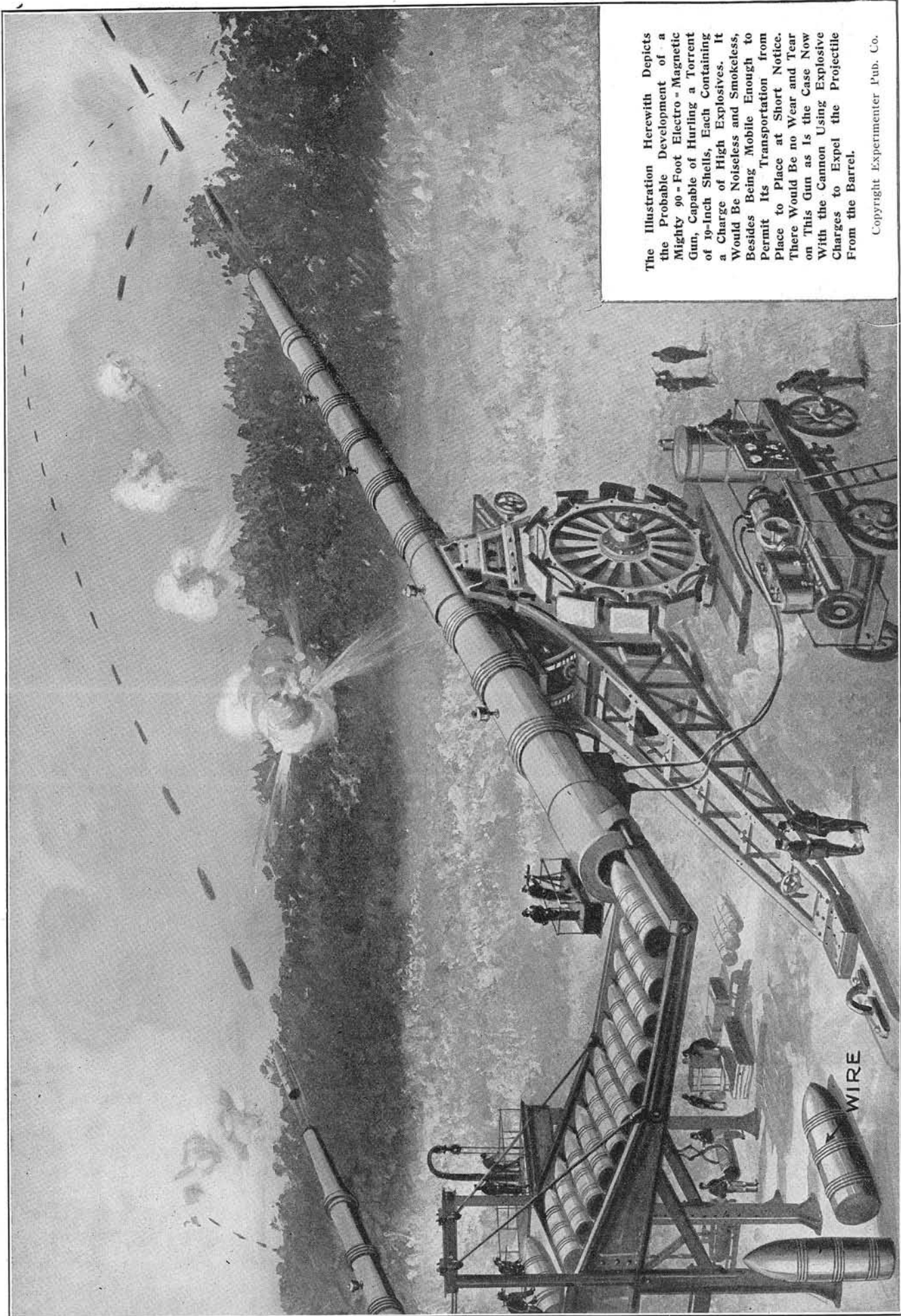

The Illustration Herewith Depicts the Probable Development of a Mighty 90 - Foot Electro - Magnetic Gun, Capable of Hurling a Torrent of 19 - Inch Shells, Each Containing a Charge of High Explosives. It Would Be Noiseless and Smokeless, Besides Being Mobile Enough to Permit Its Transportation from Place to Place at Short Notice. There Would Be no Wear and Tear on This Gun as is the Case Now with the Cannon Using Explosive Charges to Expel the Projectile From the Barrel.

Copyright Experimenter Pub. Co.

Fig. 2. Electro-Magnetic Gun of the Future, Which Can Hurl 19-Inch High Explosive Shells 25 Miles and More. It Could Fire a Perfect String of Shells, Sufficient to Batter Down the Strongest Forts.

Baron Münchhausen's New Scientific Adventures

By Hugo Gernsback

FOR forty-one days I had been "listening in" nightly at my wireless set, since that eventful evening when Baron Münchhausen had left the Moon for the Planet Mars. He had said, of course, that it would take from 35 to 40 days before the "Interstellar" could negotiate the trip from the Moon to Mars, but nevertheless I became more and more impatient as the days wore on.

At last on the evening of the 42d day, at 11 o'clock on the second, the peculiar, unmistakable high whining spark suddenly broke in my ears. After the long nervous strain, the loud whistling spark, almost took me off my feet and I could hardly hear the first words, I was so excited. In a few seconds the whistling spark died down, and Münchhausen's dear, sepulchral voice sounded once more in my faithful receivers. And how loud it was! It was positively uncanny to think that I was listening to his "canned" voice, which perhaps 10 or 12 hours before had been hurled through the ether some 55 million miles away from the Moon, there to be registered phonographically on a telegraphone.

Münchhausen Lands On Mars

self? Too bad there is no return 'circuit,' for I would love to hear your dear voice. It's over 44 days since I have last heard it. Yet it can't be helped. Well, you must be satisfied to listen to me, without being able to talk back; but I'll try to be as explicit as possible, so that you will not be in a position to ask questions.

"Well, my boy, the trip from the Moon to Mars was entirely uneventful. As soon as we had our bearings we made straight for the Red Planet, the Mysterious. Flit-ternix and I took watches alternately and as we had learned from our former experience how to handle the 'Interstellar,' the trip became more or less monotonous. We had a little trouble at the start with the switching of the Marconium netting, for it proved rather a puzzle to gravity-insulate the 'Interstellar' from the combined attractions of the Sun, the Earth and the Moon, and at the same time having the Planet Mars alone 'pull' us. This bothered us considerably for several days

terstellar' was entirely gravity-insulated from the Moon, Earth and Sun. We were then 'falling' towards

Mars at the rate of 20,000 miles an hour. Within 10 days our speed had increased to over 50,000 miles an hour, and the Earth which from the Moon appeared 14 times as large, as the Moon appears to you, had shrunk and shrunk till it looked like a small bright red disc. Mars in the meanwhile became rapidly larger and redder and soon it appeared like an ochre disc. At the end of the 35th day, when our speed had increased to 78,000 miles an hour, due to the proximity of the planet, the Earth had become a bright star in the firmament, somewhat brighter than the other stars, but a pitiful sight compared to what it had looked when seen from the Moon. But remember that the Moon is but 238,000 miles distant from the Earth, while we were now over 50 million miles away from it. Quite a little difference!

"The next day, the 36th since our start, we were but 200,000 miles distant from Mars, and the planet at this distance was indeed the most gorgeous sight either Flit-

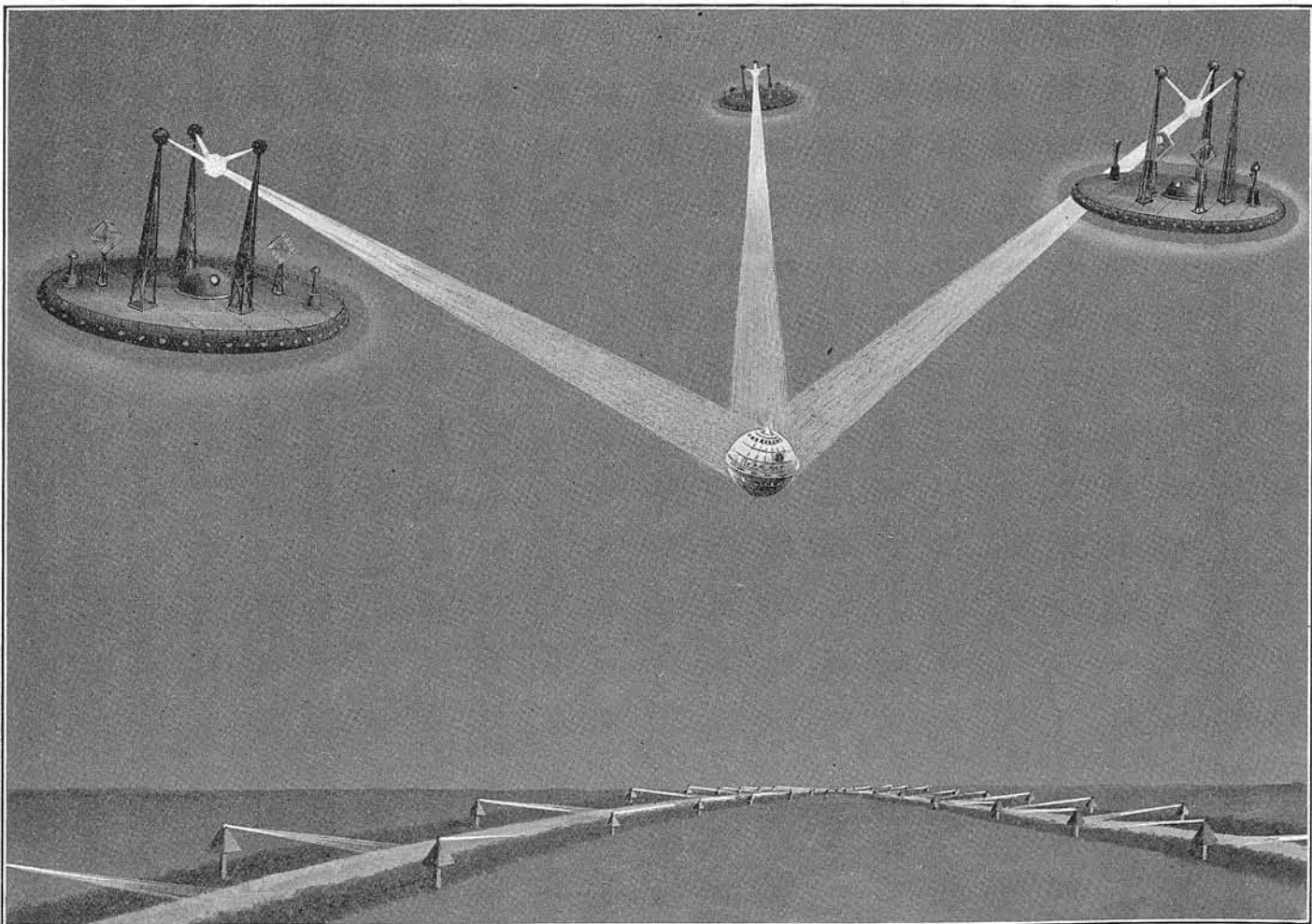

"Three Shafts of an Intense Yellow Ray Were Turned on us, and It Was the Peculiar Properties of This Ray Which Had Made us Captives to the Martians' Superior Intelligence. . . ."

And now the Baron's voice through the wireless telephone sending plant on the Moon, 238,000 miles away from me, was talking! The thought made me shiver.

"Hallo, Alier," it came in a sympathetic voice, "how is old mother Earth and your-

and we made but little headway during that period. Finally when the Moon, Earth and Sun, in the order named, were in a straight line, with Mars almost overhead, our speed rapidly increased and on the evening of the fourth day the 'In-

ternix or myself had ever witnessed. Mars looked now almost as big to us as the Earth does when viewed from the Moon. If the Earth when so viewed is a wonderful spectacle, the planet Mars when seen at such a small distance is simply over-

whelming in its splendor. We saw a full red disc, dazzlingly illuminated by the distant Sun's rays. Like the Earth, Mars has a pink fringe running around the edge—its atmosphere. The continents stand forth in an ochre red, intermingled with dark green patches. Faint lines run over the entire face of the planet, like cobwebs—the famous Martian canals. At the top a brilliant white cap is observed—the north polar ice fields.

"But the most wonderful sight to us was Mars' two little moons. Flitternix calls them toy moons! Of these we had the best view the next day, when we were but some 10,000 miles distant from Mars.

*"The Planet Mars has two tiny moons, christened Phobos and Deimos by terrestrial astronomers. They were discovered in 1877 by Professor Asaph Hall, of the Washington Observatory, and they are so minute in size that only the most powerful telescopes on Earth reveal them. The largest, Phobos, is some 36 miles

in diameter, while the smaller, Deimos, is but 10 miles in diameter. The latter is such a ridiculously small world that a pedestrian would walk around its equator in a single day! An automobile, given a fair road, could circle this entire world in one hour, without exceeding its speed limit!

"Phobos, the largest moon, is less than 4,000 miles from the surface of Mars and revolves around the latter in the remarkably short time of 7 hours and 39 minutes. Consequently the Martians witness the spectacle of their largest moon going through all its phases in 7½ hours! In a single Martian morning, therefore, Phobos can be seen to rapidly change from new moon to first quarter, then full moon, then last quarter and finally again new moon; and all this in 7½ hours! A unique feature about Phobos, too, is that it revolves quicker around Mars than the latter revolves upon its own axis. Mars turns around its axis in 24 hours, 37 minutes and 22 seconds. Thus the Martian 'day' is almost 38 minutes longer than the terrestrial day. During one Martian day, Phobos therefore has spun more than three times around Mars! As seen from Mars, Phobos appears about as large as the Moon appears to inhabitants of the Earth. Deimos, the smaller moon, is 12,300 miles distant from Mars. Whereas its larger brother takes but 7½ hours to revolve around Mars, Deimos requires 132 hours to complete its circuit, or almost six days. Deimos, however, is so far removed from Mars and it is such a tiny object that to the Martians it really does not appear as a moon at all, as we understand that term. For it must be apparent that if we view an object measuring 10 miles across from a distance of 12,300 miles, we can hardly expect to see much. For that reason Deimos, when 'full,' appears only about slightly larger than the planet Venus appears to you as seen from the Earth. Therefore the Martian nights are not brilliantly illuminated by two large moons, as some writers would have you believe. To the contrary, the Martian night is very much like the terrestrial night, except that Phobos when full appears to shed more light on Mars than the Moon sheds on Earth. For the Martian atmosphere is

considerably thinner than the terrestrial one, and for that reason it does not absorb so much light.†

"After circling around Mars at a height of 10,000 miles for some time, we finally decided to make a landing. By careful maneuvering and switching of our anti-gravitational Marconium netting, we finally descended to a height of but five miles from the surface of Mars. On account of the etherless zone of the Marconium netting when switched on, we could, of course, not see what was beneath us at

best thing we could possibly do was to submit ourselves entirely to the Martians' will. Indeed, we were so helpless that we could not have offered any resistance, even had we wanted to do so. We, therefore, calmly awaited developments, for we reasoned instinctively that we would not be harmed. Nor were we mistaken in this view.

"The yellow rays guided the 'Interstellar' over a vast distance and at the end of an hour we were gently deposited on a huge grassplot in a fairyland 'City.' The instant that our flyer's broad landing belt touched the ground the yellow rays disappeared and immediately our normal facilities were restored once more. We were free to move and to act.

"We lost no time in unbolting our steel door, and in our anxiety to get out in the open, all three of us, Flitternix, myself and Buster, our fox terrier, almost tumbled over each other. I admit that on a historical occasion like this the

first time a human being sat foot on another planet, we should have appeared more dignified as, for instance, Christopher Columbus did when he first landed on San Salvador. Sad to relate, however, there was nothing dignified nor solemn to the occasion of our landing, and this was partly due to Buster. That infernal dog insisted on running between our feet and succeeded in tripping Flitternix just as he placed his foot on the ground; if it had not been for me he would have sprawled all over the grass.

"It is a good thing that the Martians have a keen sense of humor, for the crowd that had collected around our flyer began to laugh uproariously in a queer, characteristic Martian falsetto voice. I admit that we offered a sufficient cause for amusement, the professor in his old Prince Albert and myself attired in my costume of 1797. However, we quickly managed to pull ourselves together and we blinked around us in unconcealed amazement.

"Although the Martian air is very much thinner than the Earth's atmosphere, we experienced but little trouble in breathing for our stay in the rarified air of the Moon had taught us how to breathe in thin air. We noticed immediately that the air was very pure and we did not cough once, as was the case of our landing on the Moon. The Martian air seemed rich with ozone, and we could not rid ourselves of the idea at first that we were breathing the strong air of a pine forest.

"But what held us spellbound for some minutes was the Martians themselves. I am not sure whether they were not as much astonished as we were; for as we found out later, the Martian can conceal his emotions far better than the proverbial Indian. While I was still staring at the nearest Martian with my mouth wide open, Flitternix, who had recovered first from his surprise, nudged me and said: 'Didn't I tell you?'

"Only then did I remember our discourse of the previous day, when we were speculating together as to the probable appearance of the inhabitants of Mars. I remember now that Flitternix had said something like this:

"We have seen on Earth that animal life is possible under the most adverse conditions. We find life at the North Pole in the most awful cold, and we find life at

IS Mars really inhabited by intelligent beings? Are conditions on this Planet such that life can be sustained on it? Some of the foremost thinkers in astronomical matters answer these questions in the affirmative.

The Spectral Analysis has revealed to us of what gases and matter the Sun is composed. By means of those piercing instruments *Logic* and *Deduction*, we are enabled to tell what is going on on Mars. This story advances some new ideas on the subject and we have a hunch that you will enjoy this installment.

all times, for light does not pass through an etherless zone. We therefore had only momentary glimpses of the planet during the short seconds when the current in the netting was switched off. This constant switching on and off of the current reduced our speed to almost nothing, and we were thus slowly approaching an open plain which we had picked out and which appeared like part of a desert, and probably sandy enough to effect a soft landing of the 'Interstellar.' From our momentary glimpses we had become more than convinced that the planet must indeed be inhabited by intelligent creatures. We had snatched a good view of a wonderfully built city; had seen sections of the mysterious long waterways and their attending strips of vegetation, otherwise known as the Martian canals, and had also observed ponderous air craft by the thousand and curious structures near the canals that looked like gigantic pyramids.

"Had we still doubted that Mars was inhabited we were taught differently in a few minutes, for things began to happen rapidly.

"When we were still about two miles from the Planet's surface, suddenly as if by magic, everything before our eyes became yellow. At the same time a peculiar numb sensation came over our bodies and we were hardly able to move hand or foot. Simultaneously the machinery of the 'Interstellar' became unmanageable, and looking through the lower portholes we could see that we were rapidly coming closer to the planet's surface, at the same time moving in a totally different direction from the one we originally were heading to.

"With some difficulty we managed to look up towards the top port windows and we saw a marvelous sight. Three circular massive, what looked to us like metal aircraft, spaced equal distances apart, were floating in space. The three flyers formed an equilateral triangle while in the exact center, but about one mile lower down than the flyers, our 'Interstellar' was floating. Three shafts of an intense yellow ray were turned on us and it was this light, or rather the peculiar properties of the rays which had made us captives to the Martians' superior intelligence.

"We reasoned that these floating forts must be used for defensive purposes on Mars, and we agreed among us that the

* In order to distinguish facts from fiction in this installment, all statements containing actual scientific facts will be enclosed between two † marks.—AUTHOR.

the equator in the most intense heat. We find life in the thinnest mountain air, and we find life at the bottom of the ocean. Particularly the latter is interesting for even up to a few years ago scientists of note denied that a fairly large creature such as a fish could withstand the enormous pressure of water at the bottom of an ocean. For the scientists argued that the fish would be crushed to death by the thousands of tons of water above it. Not only that, but it was furthermore argued that as it gets colder as one descends into the depths of the ocean the temperature finally drops below the freezing point of fresh water. How then could a fish live in such an abode? It was simply impossible. The fish might just as well live in a frying pan. The arguments were strong indeed against the possibility of life at the bottom of the sea.

†“But then a man by name of Challenger came along and invented a deep sea dredge. No sooner had his expedition begun to dredge than they fished from the bottom of the ocean the most astounding specimen of deep sea fish built on a plan to withstand enormous pressures. True, they were dead when they arrived at the surface of the ocean, but this was expected, for as soon as the enormous pressure to which the fish was accustomed was taken away, he naturally burst inside. So our “wise” scientists with their beautiful logic were wrong once more and the impossible, as always, was very much possible.†

“I mention this only in passing, to show you that life can accustom itself to almost any condition. There are indeed but few exceptions to this rule to my mind. Now, then, we have absolutely no right to believe that the little planet Earth, among the billions of worlds, should be the only fortunate one on which life thrives. †Arrhenius has demonstrated already how life is propagated from one planet to another. This famous philosopher has shown, that minute life carrying spores so small that they cannot be seen by the naked eye are carried through space, propelled by the pressure of the sun light till they strike another heavenly body. If the conditions are suitable the spore will germinate in time and life will spring up—if it is not there already—on that world. It has been proved that these spores can exist in an absolute zero and in a perfect vacuum for years, without losing their germination power—another proof how nature protects life under almost unbelievable conditions.† Therefore to say that there is life only on the Earth is not only idiotic in the extreme, but it also reveals a total lack of appreciation of the wisdom of Almighty Nature.

“Now, then, it is an undisputable fact that plants, animals as well as humans, are entirely dependent upon their surroundings. If, for instance, you take an Eskimo and transplant him and his family on an island under the equator, his white color will change into black in a few generations. Likewise evolution shows that the human body very quickly adapts itself to the tasks imposed upon it. Thus a man whose grandfather and father were hard-working laborers, will nine times out of ten inherit a bony as well as robust body and a relatively small brain. Whereas a man whose grandfather and father were mathematicians nine times out of ten will have a comparatively small boned body, which is far from robust, but his brain will be large.

“Surroundings are everything and given time they will transform man or animal into different beings than they were originally.

“Now let us apply this reasoning to Mars and let us see what we will find.

†To begin, it has been proved beyond dispute that Mars has an atmosphere, which although thinner than that of the Earth, is probably thick enough to sustain human life even as we know it. Professor Lowell has proved that the mean temperature on Mars is about 47 degs. Fahrenheit. In some sections as, for instance, near the equator, the temperature can surely not be less than 65 degs. F. It was argued in former years that, on account of the far greater distance Mars is removed from the Sun than the Earth, the temperature must be far below zero. Recent astronomical researches, however, completely disproved this. As a matter of fact, Mars proper receives really more heat than does

world than the Earth. Civilization on Mars must date back several hundred thousand years. The law of evolution teaches us that we must therefore expect a very cultured as well as accomplished race.

“As our terrestrial evolution shows, the human head is growing larger and larger all the time. It must have been the same on Mars, for conditions here are almost the same as those on Earth. We must, therefore, expect to find a race with enormous heads. As the air is thinner on Mars sound will not carry as well as in a thicker atmosphere. We, therefore, will expect big funnel-like ears on the Martians to enable them to hear well. But a big head almost invariably has big eyes; from this we may safely deduct that the Martians have large eyes. But there is one important difference of physical conditions on Mars, as compared with those on Earth, and that is gravitation. For what weighs one pound on Earth weighs but 0.38 pound, or a little over one-third pound, on Mars. Less bodily weight makes for excessive growth for the reason that gravity pulls less on the body frame. A little calculation based upon the above gravitational figures leads us to suspect that the average Martian should be about eight feet tall. As the sunlight is very much stronger on account of the thin air on Mars, the Martian unless he is in the shade most of the time has probably a dark skin, which may be as red as that of a North American Indian or as dark as that of a West Indian.

“As the air is so thin on Mars and as oxygen is needed in large quantities for such big bodies as the Martians, we will not be surprised to find that the Martian has an immense torso, to accommodate his ponderous lungs. The latter must be doubly large in order to sustain such a large body and also to work over quickly the small percentage of oxygen in the thin air. But large lungs also invariably require a large nose, as we know from experience, on earth. Consequently, if the Martians have a ponderous nose, don't be surprised, for evolution shows us that animals breathe through their noses as a rule.

“As to the Martian's hands, it is probable we will find them rather small in proportion to the rest of the body. The Martians have probably advanced so far that manual labor has been abolished for hundreds of generations. It is almost certain that as everything must be done with machinery, manual labor is absolutely unknown to-day on Mars. This naturally, in the course of several thousand years, begins to tell and the hands must shrink. We will therefore expect that the eight-foot Martian has a hand rather smaller than ours. Again, as no physical labor of any sort is performed by the Martian, his arms are probably thin and muscleless.

“As to his feet, we shall find them to be very large in all probability. They must support a tall and rather heavy body, and they, therefore, must provide sufficient leverage to enable the Martian to walk properly. Not alone for the latter reason must the feet be large, but also on account of Mars' small gravitational attraction; for if the Martian's feet were small, he could not secure the proper foothold to propel his body, he would be hopping instead of walking.

“Therefore when we behold the first Martian we will probably find him to look totally different from a human being, and while my reasoning as to his probable appearance may be inaccurate in spots, I am sure that on the whole I will be correct.

“So spoke Flitternix.

“He was right, marvelously right. His
(Continued on page 371.)

SYNOPSIS

I. M. Alier, an eccentric young scientist of Yankton, Mass., who claims as his own many new as well as startling inventions, far ahead of anything as yet discovered, owns the largest radio-telephone plant in the country. One evening he hears strange noises over his phones and immediately a sepulchral voice is heard. It is Münchhausen, one of the greatest yarn and story tellers of all times. Münchhausen explains how it came about that he did not die in 1797, as popularly thought, and he furthermore gives unrefutable proof that his home is on the moon at present.

Alier wants to know why Münchhausen went to the Moon and how. The latter then explains how Prussia persecuted him and how he went over to the Allies and succeeded in capturing Berlin in a wonderful manner. However, it was not a complete success, so the Baron left Europe for America. He immediately constructs a machine which is to take him into space to the moon. Münchhausen has discovered how to neutralize Gravity by means of Electricity, and he applies this invention to his space flyer, the “Interstellar.” The machine proves a success; it responds and is lifted with tremendous speed towards the moon.

Queer things are discovered on the way to the Moon, among others that bodies lose all their weight inside of the “Interstellar.” Finally a landing is effected on the Moon in a desert, but great hardship is encountered on account of the Moon's rarified atmosphere. The party then leaves for the nearest mountain range, where they discover a huge subterranean cave and a lake filled with luminous fish. Bread trees are also discovered. Münchhausen next gives a vivid description of the Earth, Sun and the firmament as viewed from the Moon; he also explains how the continents and oceans of the Earth appear from the Moon. He then tells of the ponderous meteors which continually crash down on the Moon. Finally one falls down near him and the resulting concussion hurls Münchhausen in a bottomless crater, which goes straight through the Moon. He falls clear through to the other side, but his momentum brings him back to the starting point, where he is saved by his companion. They then decide to depart for the Planet Mars, but they leave behind them an automatic Wireless Plant, the “Radiomatic,” which will relay the messages from Mars to the Moon and thence to Alier. A popular lecture on Mars is also given by Münchhausen.

THIS STORY STARTED IN THE MAY ISSUE. BACK NUMBERS WILL BE SUPPLIED AT 10c EACH POSTPAID.

the Earth for the following reasons: The Martian atmosphere is much thinner than the terrestrial, consequently the Sun's rays pierce it with far less loss than is the case on Earth. Then, too, there are no clouds on Mars to cut off almost 50 per cent. of the received Sun's rays, as is the actual case on Earth.

“Then again the Martian day is almost exactly as long as the terrestrial. Also due to the inclination of the Martian axis, which is almost exactly the same as the one of the Earth, the seasons are exactly like the terrestrial ones except that they are twice as long, because the Martian year is just twice as long as the terrestrial one.†

“Now, then, we know that the planet Mars, due to its small size, is a vastly older

Warfare of the Future

The Radium Destroyer

THE European War has clearly demonstrated what a tremendous part modern science plays in the offense as well as in the defense of the contending armies. It has often been said during the past twelve months that this is not a war so much of men as of machines. Nothing could be truer. In fact, it might be said that this is a war of infernal machines against more diabolical machines.

It has been stated editorially in this journal that there will be war always, or at least till we arrive at a period when some scientific genius (or shall we call him devil?) invents a machine which at one stroke is capable of annihilating one or several army corps. When that time arrives, soldiers, no matter how courageous, will think a long time before they will offer themselves to be slaughtered by the hundred thousand.

In the meantime, probably for many generations to come, the war death-dance will go on without any doubt whatsoever. Humanity simply has not advanced to such a state where disarmament is possible. Our real civilization only dates back less than 100 years, and as human progress is extremely slow, it may take a thousand years and more before humans will learn how to trust each other implicitly. As long as we require policemen and jails to keep us out of mischief, we are not able to take care of ourselves and we cannot call ourselves emancipated—we are still held in bondage by the brute in ourselves, which threatens to break out at any opportune moment, as is witnessed in the present war.

Therefore, the pacifists, particularly those in our country who think that this is the "last war" and who go around shouting peace at any price, are not only a sorry lot, but they are cheerfully oblivious of the teachings of history as well as of human evolution.

These good people would shout murder if you dared suggest to them to dismiss at once all policemen and patrolmen of their home town, but they would trust a strange nation implicitly from making war on this country, simply because that nation pledged itself on a piece of paper not to make war!

If the present war is ghastly with its poison shells, its deadly chlorine gas, its bomb-throwing aeroplanes, its fire-spraying guns, its murderous machine guns, etc., what can we expect of the wars of the future?

What will happen when the scientists of a hundred years hence begin making war on each other?

Suppose that by that time our scientists have solved the puzzle of the atom and have succeeded in liberating its prodigious forces. Imagine that at that time one atom can be disintegrated at will, instantly into another, what will happen? The results will simply be overwhelmingly astounding and almost incomprehensible to our present minds.

It has been calculated that if we could liberate the latent energy at present locked up in a *copper one cent piece* we would be enabled to propel a train with 50 freight cars over a distance of 600 miles!

Now, then, bearing this in mind, let us imagine that 100 years hence some scientist invents a means to unlock atomic forces, and how to control them. We can see him stepping to the throne of his future War Lord (if such still exist then), addressing him in this fashion: "My Lord, with the means of my invention the world is yours;

will you make yourself the first Master of this Planet?"

The War Lord promptly asks for a secret demonstration of the new "Atomic Gun," and what he sees intoxicates his imagination to such a degree that he decides to make war on the entire world as soon as his generals have assured him that enough atomic guns have been manufactured to make success certain. And one beautiful spring morning our War Lord finds a perfectly logical pretext to make war on a few nations, and the latest war dance is on.

Within a few hours the first atomic gun, popularly known as the "Radium Destroyer," has crossed the enemy's frontier.

The Radium Destroyer is mounted on fast moving auto trucks and is controlled entirely by Radio energy. No man is within a mile of the Destroyer—it is too dangerous to be near it when in action. A young lieutenant with phones clapped over his head and who follows the Destroyer in the "Control Auto," and who gets his own orders from the General Staff by Wireless, guides each and every motion of the distant Radium Destroyer simply by moving certain keys and switches in front of him.

Soon his Destroyer has arrived in front of the enemy's first line of concreted steel trenches, protecting the land behind them. In front of the trenches the ground has been purposely cut up to impede the progress of ordinary vehicles. The General Staff, of course, knew this, and built the Destroyer accordingly. Our friend the lieutenant stops the Destroyer's truck and moves a lever. Immediately the Destroyer hops from the truck and begins to jump with amazing speed over the cut-up ground, in grasshopper fashion. A few hundred feet from the well-concealed concrete trenches the Destroyer is made to halt. Our lieutenant moves a few switches, turns a knob and presses a key—then lo! the inferno begins.

A solid green "Radium-K" emanation ray bursts from the top of the Destroyer and hits the concreted steel trench. Our front cover gives but a faint idea of what happens. The Radium-K emanation has the property of setting off spontaneously the dormant energy of the Atom of any element it encounters except lead. So when the ray hits the trench it went up in dust, concrete, steel, men and guns behind it, everything. After spraying the trench lengthwise for a few minutes it is gone completely. Only a dense cloud of vapor hanging in the air remains.

The fleet of Radium Destroyers now enters through the gap, destroying everything in their path. No gun can hit the Radium Destroyer for ere the gun can get the proper range, the Radium-K Ray has hit the gun or the ground below it and has sent it up in vapor, including the men behind it. As a demonstration, the Commanding General asks that the first town encountered, a city of 300,000 souls, be vacated within three hours. The terrorized inhabitants are forced to comply with the request, whereupon a dozen Destroyers line up on the hills and spray the unlucky city with their fearful rays. Within five minutes the entire city, houses, churches, bridges, parks and everything else have gone up in a titanic Vapor cloud; only a vast crater in the ground where the thriving city one stood remains.

After this demonstration the enemy sues for peace; resistance would be folly. The country is conquered. Within a fort-

night the War Lord has conquered the entire world and has proclaimed himself as the First Planet Emperor.

What happens afterwards when the secret of the Radium Destroyer is discovered by the War Lord's enemies is another chapter, so we will desist!

The above may read very fantastical and extremely fanciful. It is, however, not only very possible but highly probable.

Modern Science knows not the word Impossible.

ANENT WARLIKE INVENTIONS.

It is one of the anomalies of warfare that the machinery for fighting and killing has been brought to its present ghastly perfection not by swashbuckling, bloodthirsty soldiers, but by the mild-mannered, peace-loving civilians, says the *Review of Reviews*. True, both army and navy officers have exercised their ingenuity to heighten the terrors of battle, but theirs are rather academic improvements on the more daring contrivances of civilian mechanics and engineers.

Who gave us the turreted ironclad? Not a naval officer, but Ericson, a marine engineer. Who invented the machine gun, which squirts death every day on a dozen European battlegrounds? Not a colonel or a captain, but Hiram Maxim, a brilliant American mechanic. Who gave the battleship its quick-acting gun-elevating mechanism? Not an ensign or a commodore, but Janney, an American mechanical engineer. Who invented the motors for turning turrets rapidly? Not a lieutenant, but H. Ward Leonard, one of Edison's former assistants. Who planned the submarine? Not a Hull or a Nelson, but Robert Fulton, an artist.

So, one after another, the really important, the really epoch-making inventions comprising the mechanism of warfare prove to be the conceptions of romantically imaginative but lamb-like private citizens. Usually their contrivances are anything but perfect. They must be developed, and it is in their development that the professional soldier has been most serviceable.

It is thus not only with the guns and submarines of war, but also with the telephones and electric lights of peace; for the inventions that have made the United States and other countries commercially great came not from within given industries, but from without.

Always it is a dreamy pioneer, an intrepid free-lance, aflame with enthusiasm, who enriches his country with a radically new labor-saving device or way of utilizing energy. Morse was a portrait painter when he first turned his attention to the telegraph; Bell was a teacher of deaf mutes when he began his experiments with the telephone; Edison was a patentee of telegraphs and phonographs when he gave us the incandescent lamp; Marconi was a mere lad with a liking for physics when he conducted his first successful experiments in wireless telegraphy.

With the single conspicuous exception of Edison not one of the inventors who have blazed new trails gave to the world devices that could be marketed at once. Development was necessary—development by less brilliant intellects identified with the industries that were benefited.

WIRELESS ON CAPE COD.

The United States Navy will establish a wireless station on Cape Cod especially equipped to guide vessels along the Atlantic coast in time of fog.

When the Lights Went Out on the "Bella."

By A. Troubleshooter.

QUITE a few months ago, or, to be more exact, several years ago, the writer, who for the present must use the above nom de plume, had some unique experiences in overhauling the electric lighting equipment and generating plant on one of the numerous banana boats which ply between the port of Philadelphia and the West Indies. Probably a few reminiscences may be of interest in this direction, as the author had several quite out-of-the-ordinary problems to contend with in endeavoring to fix up the electric lighting equipment on this ship. She was built in England and answered to the name of "Bella."

It may be said to start with, and so that the reader will understand some of the problems encountered, that all of the wiring on this steamship consisted of a *toughly armored* copper wire, which had but a very thin rubber insulation placed between the "central" copper conductor carrying the current and its outer spiral steel wire armor. The dynamo room was located amidships in a compartment of the main engine room, and from this point, where the switchboard was also located, the various circuit wires and cables were led out through holes cut in the steel walls of the various compartments and decks to different locations about the ship. All of these lead wires and cables were armored, as aforementioned, and groups of them, containing often as many as 10 to 15 wires, were run along the steel hull of the boat or on the underside of the steel decks and sub-decks, where they were firmly held in place by means of heavy brass clamps screwed fast to the steel plates.

The "beautiful" job of chasing out a ground on one of these circuits can be readily imagined, considering that such grounds were so common on many of our visits to the steamship while she was in port that often 15 to 20 grounds would be encountered and have to be cleared up in a couple of days before the "good" ship sailed on its return voyage for more bananas and "grounds."

Sometimes the whole group of these wires would have to be released from their numerous clamps for a distance of 100 or 150 feet before the grounded wire itself would be finally separated and distinguished from the others in the bunch. It was then, of course, replaced by new wire, and in some cases entirely new circuits were run in conduit or pipe.

This vessel carried a good size searchlight projector on the navigator's bridge above the pilot house and was supplied with electric current through two large size stranded copper cables, which were rubber covered and also finished with a heavy braided outer coating. These cables were *strapped* onto the steel walls of the boat and compartments, and one of the largest size "grounds" ever seen in captivity was presently discovered, and existing on one of these searchlight feeders.

The ground was tested at the switchboard in the dynamo room with a magneto and, of course, no great trouble was thought to be in store for the "troubleshooters," as it was thought possibly the cables had by *electrolysis* become grounded at some point along their course. But, lo

and behold! when this cable was traced from the switchboard it followed the wall of the engine room forward toward the front of the vessel and disappeared through a tightly fitting bushing in the steel wall of the engine room. At this moment it was thought that by simply going up to the deck and re-entering the "hold" through the coal bunkers that this cable would be in sight again of course. We supposed it simply passed through a ½-inch steel wall *only*, but instead it passed directly through a steel "bulk-head" about 10 feet thick, and the only way to get inside that "bulk-head" was to cut a hole through the steel shell of same. If it had been possible or convenient at the time I suppose we trouble-shooters would have been at liberty to use an oxy-acetylene flame to cut a hole through the "bulk-head." This problem was finally cleared up by running a cable

manifested an exasperating habit of "extinguishing" itself automatically about four times a minute, more or less; usually more. Thus it behooved us to carry a large supply of matches in our pockets, as it was no small joke to be way down in one of the lower decks without a light or even a match at night, when about 5,000 rats used to hold pow-wows in the center of the floor.

One of the most exciting explorations conducted on this steamship was about the "steenth" visit we made to her and which became necessary in order to repair the *stern signal light*, which was secured to the rail about the deck. In order to get at the wire supplying this *stern* light it was necessary to crawl into the sail and paint store-room in the stern of the boat, and which was packed full of canvas and other miscellaneous "junk" to within about 1½ feet of the ceiling, or, rather, the underside of the deck. The writer crawled in on top of these sails and whatnots in this instance for a distance of about 40 feet. This hair-raising and adventurous excursion, which was accomplished by wiggling along on the stomach, was also accompanied by much muscular exercise entailed by the necessity for manipulating one of those *famous*, forever smoking, coal-oil torches in one hand, while in the other a five pound ball-pean hammer served to snuff out the life of about 400 regular sized (4 to 6 inch) bandy-legged spiders, and also several dozen 12-inch centipedes thrown in for a good measure. This may sound somewhat "tame," but when it is realized that a bite from one of these centipedes or spiders (which thrive, of course, primarily in the West Indies, where the bananas grow) means death in 10 minutes or less, it will be seen that this was "some" job.

When the trouble-shooting "staff" first tackled this boat problem, with her numerous grounds and other complaints, they were, needless to say, *some tall land-lubbers*, and it very shortly became necessary for the rapid expedition of the work that they pick up the *language* of the ship, such as "for'd" and "af't," and it was very funny at times when some of the electricians would get so mixed up with the various locations of circuits about the ship that they did not know when asking one of the crew for information whether they were going in the right direction or not. The "staff" that endeavored to care for the "Bella's" diseases and complaints had a large variety of experiences before they got finished with the job, and some of these included being hoisted up the main mast in a boatswain's chair, which consisted of a piece of planking with a rope secured to same at either end and which was then fastened to a single rope passed through a tackle block at the top of the mast. One of the boys really got so used to this "bobbing up and down" on the main mast that he could always smell trouble a mile off, especially on a clear spring day, and emanating *particularly* and *only* from one of the "signal" lamps at the peak of the mainmast.

To cap the climax, and because the trouble-shooters had not finished up all of the circuit troubles on board on one of (Continued on page 373.)



"Electrical Trouble-Shooting on the Good Ship 'Bella' Was Somewhat Exciting, to Say the Least."

up to the top of the engine room and along the deck, and so on up to the searchlight on the "bridge."

Moreover, this job was not only that of a trouble-shooting expedition, but also about 50 per cent. of the time was occupied in killing multifarious and multitudinous myriads of a heterogeneous mob of "scorpions" and "centipedes," some of which were large enough to fill a soup plate. The greatest variety of poisonous "bugs" and other kindred *animals* of this character that were ever encountered in the writer's experience were met with on this memorial trouble-shooting raid. All sizes and colors of spiders, from those as large as a 5c. piece up to those ½ foot in diameter were frequently met with in our travels about the boat, especially at night, when we often explored the cavernous depths of her hold by the scintillating illumination of a smoky coal-oil torch, which

What the Housewife Should Know About Electricity.

By L. Shaw, Jr.

"I WANT to buy an electric fan," said the young woman with a sweet voice and smile that blended perfectly.

The salesman was equally affable. With a reciprocative smile retorted:

"Yes, madam, 'A. C.' or 'D. C.'?"

The radiant countenance changed as if by magic to one of perplexity, which was plainly evident by the intended purchaser nervously biting her lips.

The salesman's query resembled much the ever-mystifying technical phrases of the family physician.

The lady in question realized that she should have been versed in the matter of buying an electric fan, but being probably the first one she had purchased, accounted for ignorance on the subject. However, it calls to mind one clear and important fact: That since the use of electricity has entered into the household something in a primary way should be learned about it. Ignorance or indifference may cause much annoyance and often fatal results.

The average housewife has an insight as to the workings of her sewing machine and a general layman's knowledge about coal gas; then why not know a few simple imperative things concerning electricity?

Automatically the second question arises: "What should the housewife know about electricity?" The incident of the electric fan answers one query. The kind of current supplied to the house, whether it is "alternating current" ("A. C.") or "direct current" ("D. C.") should be known. The next essential thing to know is the "voltage."

Taking chances is poor policy where electricity is involved. This was only too well realized by the woman who bought a 110-volt fan and connected it to a 220-volt circuit. The fireworks which resulted afforded much amusement to the children and the maid who witnessed the display on a date that was nowhere near the fourth of July, but the husband who paid for the fan did not seem to think it such a funny incident.

Voltage and kind of current are imperative bits of information to one who would purchase any heating or electro-mechanical appliances, such as the former, an electric stove, percolator, sad iron, soldering iron, or the ordinary Mazda or carbon electric lamp. In heating devices the kind of current is not so essential as being versed as to voltage. The latter is important. In the second instance, while there are electric fans and vibrators which

are "wound" to take either alternating or direct current, it is more common for such apparatus to be made to work on one or the other current. Knowledge of the voltage is absolutely essential in both instances cited.

As it is probable that the reader of this magazine is of the mere male sex, the writer humbly suggests that his audience make an earnest attempt to enlighten his mother, sister or wife (or intended spouse) with a few simple, common facts about the general uses and application of the electric current common to the household.

In order to show how much enlightenment is necessary another case of no less import than already cited is recalled to the

Incidentally I had been demonstrating a large festoon to a prior customer, but they were of the battery type. I was unscrewing the bulbs with the intention of replacing them into the box and laying them near by for the next customer. Without the least opportunity to make intelligent inquiries as to the type of lights she wanted my lady, with the breezy ways, in a Napoleonic fashion pointed to the battery festoon to which I alluded, threw down an engraved visiting card, flew out of the store and before I had time to realize it the limousine had disappeared. I obeyed her commands, sending by special messenger 12 (eight-light) festoons. My only guide being the command and the daintily engraved card upon which was scribbled: "12 festoons" (whoever wrote it had found out at least that they were termed "festoon"), but had apparently forgotten to write the voltage and left it to the discretion of the salesman. Even the most intelligent discretion used is sometimes miscarried. In this instance it might have been that the lady wanted the battery type for her country home, where oil lamps were still in vogue. Or she might have desired to present them to a friend or relative not so fortunate as to have electricity in the house.

To make a long story short, the 12 battery festoons were returned the day after Christmas, every lamp of which was completely burned out, accompanied by a curt note, criticizing quite openly the fact that the writer was not a mind reader and adding insult to injury by demanding a credit for the goods, also gently reminding that the Yuletide in a Fifth avenue mansion was completely and wantonly obliterated. On Fifth avenue, as might be known, 110 volt current is used. Merely as a matter of courtesy my firm adjusted her claim, although it can be clearly seen that the breezy limousine lady was too busy and indifferent to see that she gave an order correctly. It is even more important, where a hasty delivery is desired, to make sure that an order of this kind is properly given.

The electric meter or the label on an ordinary electric lamp will quickly determine the kind of current and its voltage. A few brief intelligent questions at time of purchase and studying printed matter, which often accompanies such purchase, will often obviate considerable inconvenience and perhaps accidents—often fatal.

So get busy Mr. Man and tell the women folks something about electricity. It may save you money.



The Lady From the Limousine Gave Me an Imperative Order to Send "12 Festoons Like Those," Without Even Thinking of Voltage, and Disappeared Forthwith.

mind of the writer.

About two Xmastides ago, during the rush so common at that time of the year, a lady whose limousine and livery which stood outside and general appearance bespoke of money and culture, stepped to the counter where I happened to be assisting during the holiday rush and in apparent hurry picked me out and demanded in a very pompous manner that she wanted some "Christmas tree" lights (festoons).

COMPARATIVE COST OF CANDLE AND ELECTRIC LIGHT.

Engineers of the New York Edison Co. have recently concluded a series of tests showing the comparative costs between candle light and electric light. In spite of the fact that candles may be purchased as cheaply as a cent each, this is the most expensive illuminant available.

One cent will furnish 2.68 candlepower-hours of candle light. For the same money and using the drawn-wire Mazda lamps 120 candlepower-hours may be obtained, while the recently perfected gas-filled lamp will give 192.3 candlepower-hours.

The figures are the result of tests with

six candles of the ordinary commercial types. Four were tallow and two were sperm. They varied from 4.875 inches to 5.75 inches in length, and were from 0.75 to 1.125 inches thick. Three cost one cent each, two cost two cents each and one cost 3.5 cents.

One of the one-cent candles burned 2 hours and 22 minutes, another burned 2 hours and 24 minutes, while the one-cent sperm candle lasted 3 hours and 47 minutes. The two-cent tallow candles lasted 4 hours and 24 minutes and 5 hours and 31 minutes, respectively. The 3.5-cent sperm candle lasted almost 9 hours. The cost of electricity was computed at 8 cents per kw.-hour.

MARCONI PLANS CONTROL OF AIR.

Wonderful stories are being whispered of a new Marconi invention. It is declared the inventor of wireless telegraphy has found a way to utilize Hertzian waves in such manner that aeroplanes can be brought to a standstill and held immovable in the air. Experiments, so the report goes, have been conducted with great secrecy until the invention has been perfected and soon will be in use. The mind picture presented of air machines held stationary in the air while guns of the enemy below were shooting them to pieces offers a new thrill of horror for followers of war news.

Something About Selenium

SELENIUM is one of the most puzzling elements known to the scientific world, due to its extraordinary property of varying its electrical resistance when exposed to light. This phenomenon has been known for many years, but the commercial application of this property possessed by selenium has not been properly appreciated up to the present time.

"selene" (moon); this being the result also of the striking similarity of the properties of selenium with those of tellurium, which is a term derived from the Latin "tellus" (earth). It is a metallic element of the sulphur group and has neither taste nor smell. It melts at 212 degrees Centigrade, and if allowed to cool rapidly from its molten state it forms a brown

amorphous mass, and in this condition it is a high-class insulator; it is said that a small stick represents a resistance equivalent to a wire stretching for about 250,000 miles. The reddish vapor produced by boiling selenium, which has a decided smell of radishes, is exceedingly poisonous, and care should be taken when experimenting with it when it is in this boiling state. In commercial form, selenium exists in sticks resembling a gray sealing wax, and if it is to be used for making selenium cells it must be chemically pure.

Webb, Clausen and Bronck, Mercadier and Fritts.

The two cells to the extreme right and left are modifications of Shelford Bidwell's cells; the one in the upper left-hand

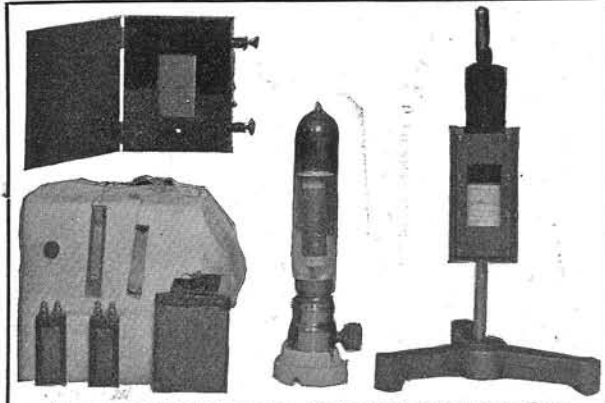

Fig. 1. Several Specimens of Successful Selenium Cells.

It is the purpose of the writer in preparing this article to make known the properties and enumerate some of the useful applications of selenium, which undoubtedly will be valuable to the readers who are interested in scientific research, as there is a promising field for the use of this marvelous element.

This peculiar substance, discovered in 1817 by Berzelius, an eminent Swedish scientist, is a by-product from the distillation of sulphuric acid from iron pyrites

Selenium cells are usually made by winding two bare conducting wires side by side around a piece of mica, slate or porcelain and coating them with a thin layer of selenium. An excellent description of how such a cell is made is given in the August, 1914, issue of this journal. Such cells vary in resistance from 2,000 ohms or more in the dark. This depends mainly upon the thickness of the selenium coating and the amount of light acting upon it; also upon the very important annealing of

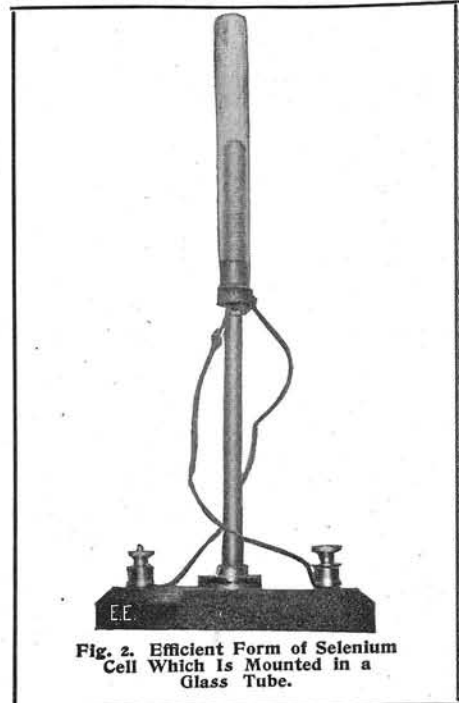

Fig. 2. Efficient Form of Selenium Cell Which Is Mounted in a Glass Tube.

corner is the Ruhmer tube form of the Bidwell type. The one to the right is a Giltay cell. The four tiny ones shown

against the white background were made by Mr. Webb, which are also forms of Bidwell's cell, while the center one is of the Fritts gold-foil flat type, which is extremely sensitive. William J. Hammer has patented an exhausted cylindrical cell, made of quartz, so as to allow the ultra-violet rays which will not pass through the glass to readily affect the selenium, which is coated over the surface of a copper tube mounted on a central support; over the selenium is a thin tube of metal such as aluminum foil, thin enough to allow light to pass through. The copper and aluminum connect to the two electrodes.

A very sensitive selenium cell was made by Samuel Cohen, and is illustrated in Fig. 2. It consists of a number of circular metallic disc separated by mica, and the sides are coated with a thin coat of selenium. The complete unit is placed in an exhausted glass bulb

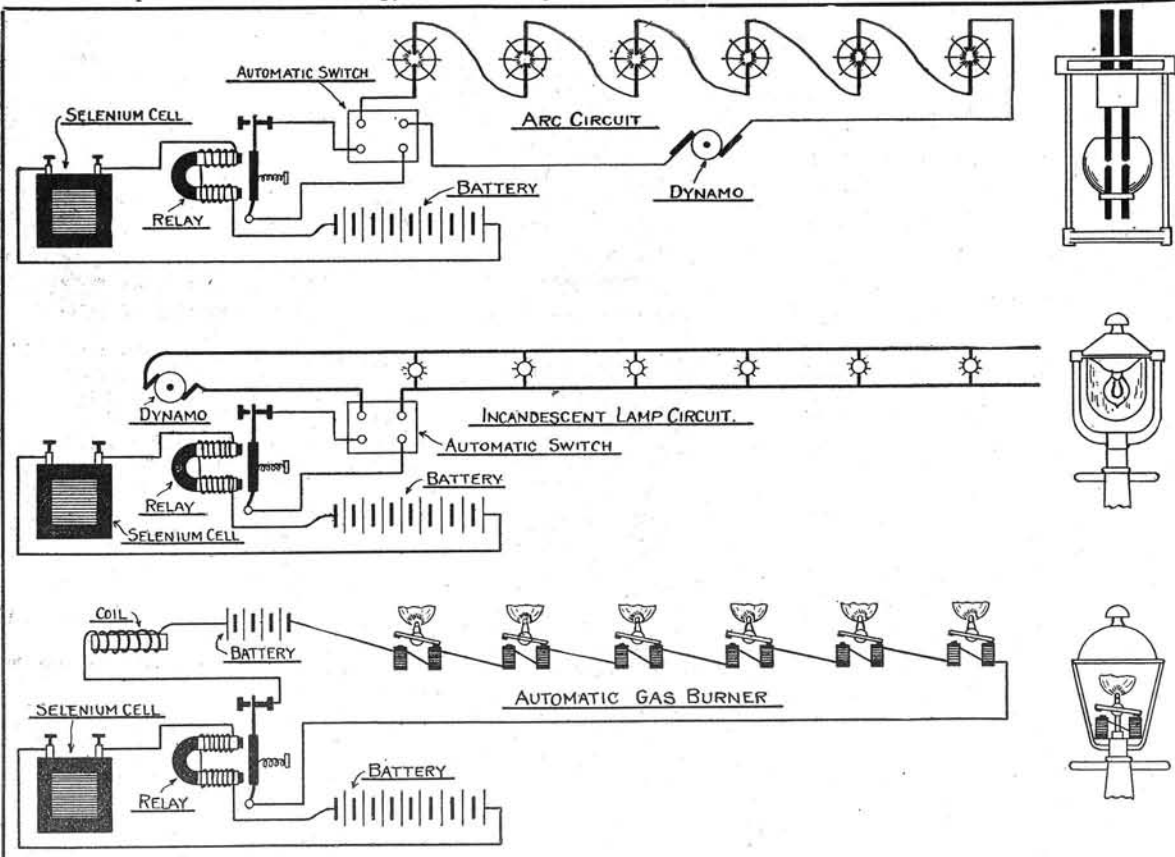

Fig. 4. Scheme for Turning On and Off Street Lights by Means of Selenium Cells, as Devised by William J. Hammer.

(a sulphite of iron). The proximity of the earth and moon suggested to Berzelius the name "Selenium," after the Greek

the cell. In Fig. 1 is shown an illustration of a number of types of selenium cells, including the Bidwell, Ruhmer, Giltay,

ated by mica, and the sides are coated with a thin coat of selenium. The complete unit is placed in an exhausted glass bulb

as shown. A small concave mirror is placed behind the cell for concentrating the light at the rear of the selenium surface.

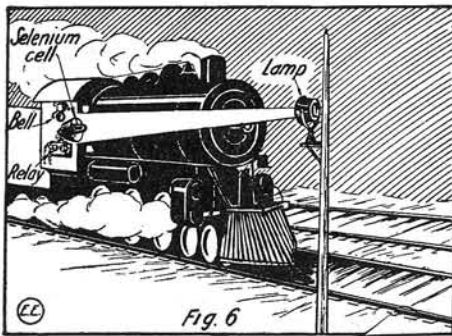

Fig. 6. Selenium Cell Applied to Safety Stop for Railroad Trains.

Having thus briefly glanced over the properties of this element and certain types of cells, we are now ready to consider some of the commercial applications of the selenium cell, some of which already have been worked out in actual practise.

Fig. 3 depicts the general connection of a selenium cell, battery relay and its secondary circuit. The selenium cell is connected in series with several cell batteries and a relay. As soon as the cell is placed in the dark its resistance is increased, consequently decreasing the current in the

light is brought near the selenium the resistance drops, thereby allowing additional current to flow through the windings, which attracts the relay armature and in turn closes the secondary circuit. This is the fundamental circuit of most devices which are operated by selenium, and the principle holds the same as in this case.

A very interesting and practical application of this element is in the automatic lighting and extinguishing of street lamps. Fig. 4 shows a schematic arrangement which has been actually demonstrated by William J. Hammer. This scheme he submitted in 1886 to the convention of the Edison Association of Illuminating Companies at Rochester, N. Y., during a discussion upon "Metering Versus Contract Systems." Such a method of utilizing selenium cells to control relays and magnets, which would turn off the gas lights

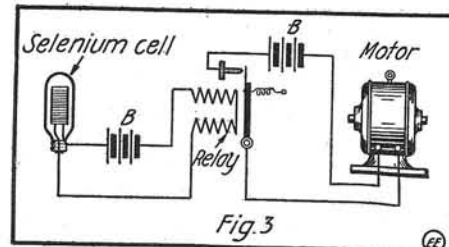

Fig. 3. Standard Connections for Selenium Cell and Relay.

on the approach of day and turn them on again at night, would solve the problem of employing a squad of men necessary to do this work at present.

Two other applications of selenium devised by the same inventor, similar to the device just described, are an automatic window shutter, illustrated in Fig. 5, that will close the shutters at night and reopen them in the morning automatically, and a very striking use of selenium in the protection of safes, storage rooms, etc., where the selenium cell is so placed in the room that whoever enters with some illuminant will be detected by means of the cell. Thus, if a burglar should enter the apartment the light from his lantern will be caught by the cell, which will actuate a bell signal, thus giving an alarm, enabling the police to surround the premises.

Automatic signaling to engineers on railroad trains, etc., can readily be accomplished by the proper use of selenium cells, and Fig. 6 depicts such a device which consists of a searchlight placed some distance away from the signal block. The apparatus on the train constitutes a selenium cell, placed as perceived, with a relay properly connected in series with some source of current, and a bell or any other signaling device. Now let us suppose the train, traveling at a high speed, approaches the signaling block. The engineer's attention, for some reason, is drawn away from the block, which shows a distress signal. This negligence may

perhaps result in a tragic accident. On the other hand, let us suppose that such a device as above described were installed

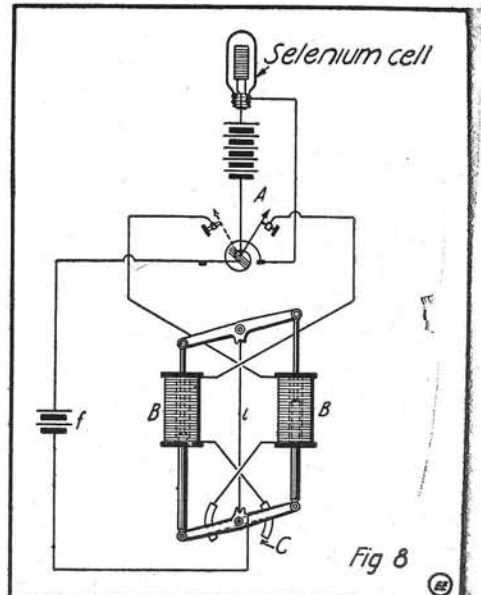

Fig. 8. Circuits of Gas Lighted Buoy Controlled by Sun's Rays Affecting Selenium Cell.

on the train and a searchlight placed about 600 yards before the block. Now, when the train passes this lamp it will immediately cause the selenium cell to close the relay, thus ringing the bell, which would be an announcement to the engineer that the signal block was being approached. Of course this particular scheme would be used only nights. In this way some fatal accidents might be avoided. A more elaborate device was devised by Mr. Hammer, whereby a bell was rung, the whistle blown and the brakes set automatically when the semaphore and signal light showed that the line was blocked. His system is arranged to operate both night and day. A system of this nature is very practical and, if properly developed, will undoubtedly prove quite successful.

Still another practical application of the selenium cell has been made by the late Ernest Ruhmer, of Berlin, Germany, in connection with a Pintsch gas buoy. A large number of these have been built containing a supply of compressed gas which would last for one month. But it was necessary to burn these lights day and night, it being impracticable by reason of the distance at which they were placed and the frequency of the storms, etc., to turn off the gas so that it would not burn during the day.

Mr. Ruhmer, however, placed one of his selenium cells in the top of such a buoy, connected with a switching device which, as soon as the sun rises in the morning, causes the selenium to reduce

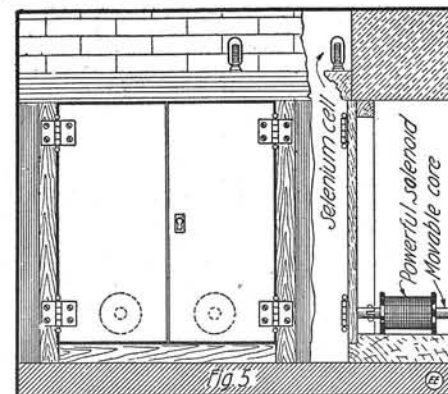
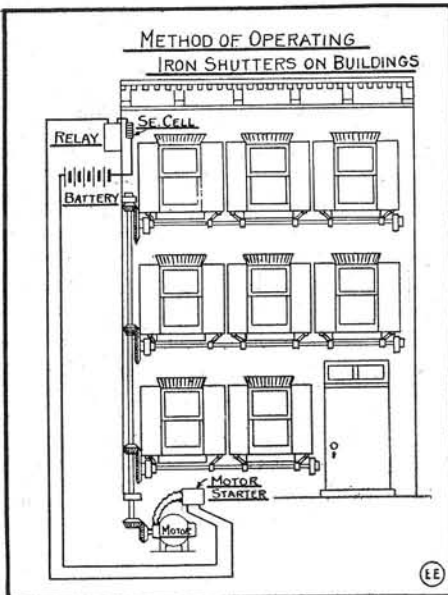

Fig. 5. Two Schemes for Opening and Closing Window Shutters at Sunrise and Sunset by a Selenium Cell.

relay coils. The secondary circuit is therefore open, but as soon as some source of

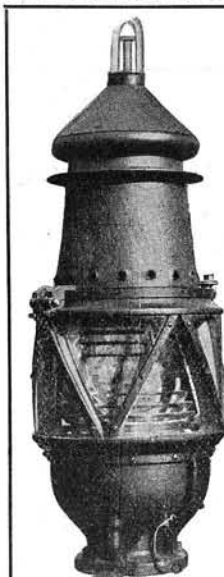

Fig. 7. Complete Gas Buoy With Selenium Cell Control.

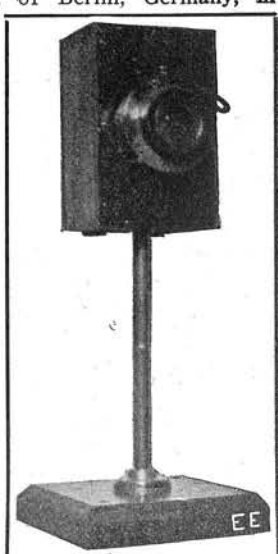
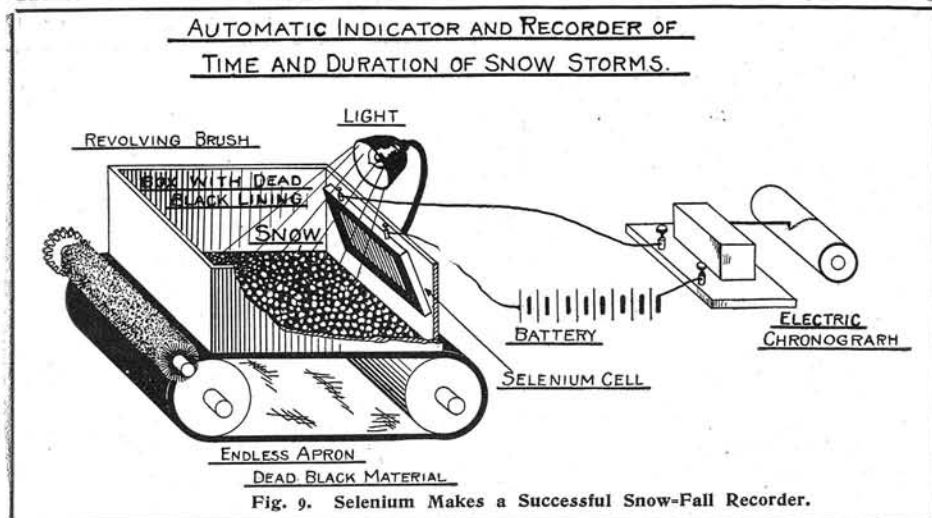

Fig. 10. Special Selenium Cell Device for Timing Photographic Shutters.

its resistance, thus causing the mechanism to turn off the gas. It is again turned on, due to the increase of resistance of the

Prof. Barnard, of Lick University, employed experimentally a selenium cell as a device for automatically detecting

instrument for measuring time intervals. A small circular brush is placed near one end of the belt for removing the snow as the belt is slowly revolved by the pulleys. The complete apparatus is placed outdoors with the exception of the recording device, which in this case is the chronograph. The drums are now started. As long as it snows, the snow upon the slowly moving belt will reflect the light produced by the electric bulb upon the selenium cell and in turn indicate on the chronograph, and as soon as it stops snowing the black surface of the belt absorbs the light, thereby preventing the selenium cell from obtaining sufficient light; consequently it will not show upon the scale of the recording instrument. Such a device is very practical, as it will show exactly and accurately the time when it snowed and how often it snowed during the night, it being a simple matter to keep the record during the daytime. At present there is available for the Weather Bureau only an instrument which measures the depth of the fall of snow in a box protected from the wind to prevent drifting.



cell, by the approach of nightfall, or also, if so desired, in the case of darkness due to a storm or fog. A buoy containing sufficient gas for one month could thus be made to do actual service without recharging from three to five months. Such a buoy is shown in Fig. 7. Mr. Ruhmer told Mr. Hammer that upward of 100 of these buoys had been made and had given excellent satisfaction.

The arrangement of the circuit, as originally devised by Mr. Ruhmer, is shown in Fig. 8. The voltmeter needle A has been replaced by the relay. B, B are two large "sucking" solenoids for operating the gas valve. A single dry battery is interpolated in the selenium cell circuit as usually employed. This battery will last for years and, with its relay, is placed in the bottom of the buoy and arranged to be absolutely waterproof.

Sir William Crookes has constructed an exceedingly interesting type of his well-known radiometer, in which he has coated the revolving vanes on one side with selenium and on the other with chromic acid. He found that the white light from a sperm candle repelled the selenium, while the yellow light of the wax candle

comets, and Minchin has employed the selenium cell quite extensively in his astronomical investigations.

A very ingenious device, using this wonderful element for recording elec-

A very striking experiment has been performed with selenium by S. Cohen in recording the speed of photographic shutters. The apparatus is shown in Fig. 10, and virtually consists of two selenium

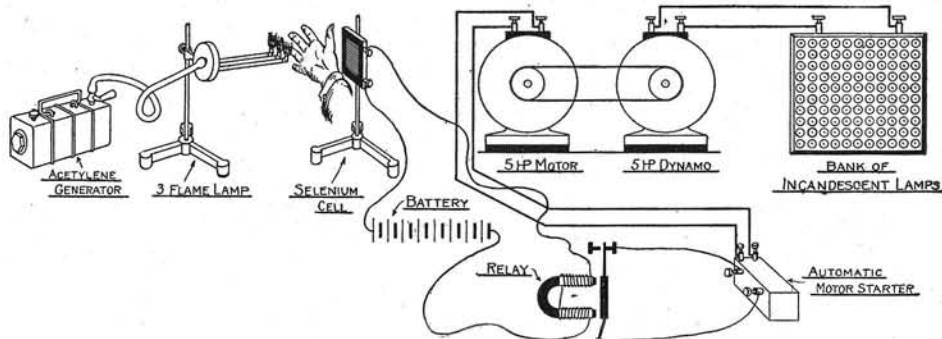

Fig. 11. Arrangement as Used by Wm. J. Hammer for Controlling a 5 Horsepower Motor by a Wave of the Hand.

trically the amount of snowfall which occurs during a certain period of time, was devised by Mr. Hammer and is illustrated in Fig. 9. It consists of an endless black belt or conveyor, mounted on two reels

cells, properly compensated with a Wheatstone bridge and galvanometer, whose needle is placed upon a chronograph cylinder having a proper scale divided in fractions of a second. The operation of this device is as follows:

The Wheatstone bridge is very finely adjusted and a light from an incandescent electric lamp is placed near the shutter; the chronograph is started and the shutter is released. The small amount of light which passes through the shutter acts now upon the selenium cell, thereby reducing its resistance and in turn unbalancing the complete circuit. Momentarily, in turn, it deflects the galvanometer pointer. This is recorded upon the scale of the chronograph. The time is then read by the length of the line made by the needle. This device has been worked out in practise and it is another achievement in electric speed indicating devices.

Still another wonderful experiment was performed with the selenium cell by Mr. Hammer at the joint meeting of the American Institute of Electrical Engineers and the American Electrochemical Society, April 17, 1903. The amazing feat accomplished by him was starting and stopping a five-horsepower electric motor by a mere wave of his hand in front of a selenium cell. The apparatus used in this experiment is shown in Fig. 11. It consists of an acetylene generator supplying gas to a burner placed before the cell, as shown. The cell is connected with a relay

(Continued on page 373.)

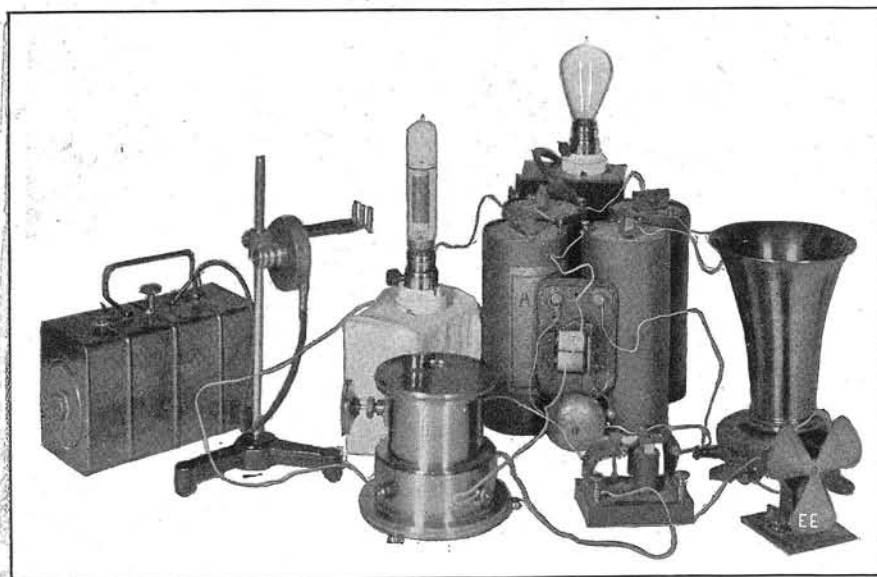

Fig. 12. Selenium Cell and Auxiliary Apparatus for Laboratory and Lecture Demonstrations.

repelled the chrome, thus indicating the relative absorptive powers of the different substances for rays of different refrangibility resulting in mechanical motion.

and forming the bottom of a box as depicted. A selenium cell is placed above this belt and is connected with a suitable battery and an electric chronograph, or

Wireless Telephony Now From Washington to Honolulu.

THE most wonderful feat in wireless telephony was accomplished on the night of Sept. 29 last, when the human voice was projected through the ether from Washington, D. C., to Honolulu, a distance of 4,900 miles!

tary Daniels said:

"I am pleased to announce the successful outcome of experiments which have been carried on for the last few months by the American Telephone & Telegraph Company and the Western Electric Com-

pany. Signal Corps of the army, representatives of the technical and operating departments of the Navy Department and a few other interested parties.

"After this successful demonstration, conversation originating in New York

Views From Left to Right: Dr. Lee de Forest in His Laboratory. Dr. de Forest Holding One of His New Regenerative Audion Bulbs of the Type Used in 4,900 Mile Radiophone Talk. Top Right: Shows Mr. Theo. N. Vail, Talking From New York to San Francisco by Wireless (via Arlington). Bottom Right: Progression From First de Forest Audion Detector at Right, to Latest Oscillation Tube Generator at Left.

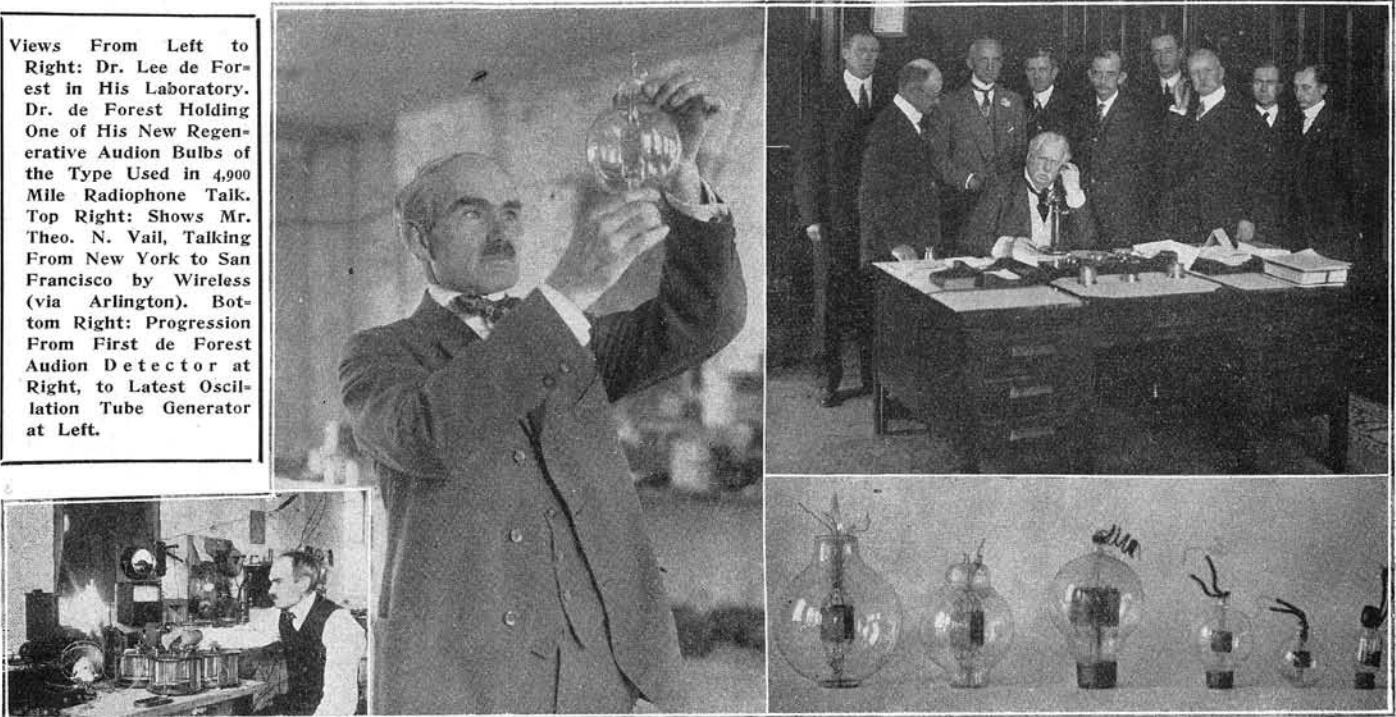

Only a few hours earlier wireless telephonic communication had been established between New York City and San Francisco, a distance of 2,500 miles, which was heralded as an epochal innovation.

Secretary of the Navy Daniels has announced the successful transmission of wireless telephone messages from the United States naval radio station at Arlington to the naval radio station at Mare Island, Cal., a distance of about 2,500 miles. All that was necessary to carry on this transcontinental wireless telephone conversation, he said, was to connect the receiver and transmitter apparatus of the special telephone outfit with the radio apparatus and send the message.

Captain W. H. G. Bullard, U. S. N., who is in charge of the Arlington station, and other officers of the navy conversed with officers of the navy on duty at the Mare Island yard in San Francisco.

The demonstration was the result of experiments that have been in progress for some time, and their success is expected to have a revolutionary influence on communication between American naval vessels and shore stations. By means of this perfected apparatus, which probably will be installed at all naval radio stations, it is expected that officers of the navy on land will be able to carry on wireless telephone conversation with officers at sea. Captain Bullard stated that the apparatus had been perfected to the point where a person on shore might carry on a long distance wireless telephone conversation with a friend on a transatlantic liner in mid-ocean, whenever shore station and liner were equipped with the necessary apparatus. In his formal announcement, Secre-

pany in co-operation with radio stations under the jurisdiction of the Navy Department by which long-distance wireless telephony has been made possible.

Speech has been successfully transmitted from the Arlington radio station to the radio station at Mare Island, Cal., and there successfully received, thus making possible conversation without wires over a distance of approximately 2,500 miles, the first time this great distance has been covered by wireless telephony. In the first experiments the voice was success-

fully transmitted over the land wire to Arlington, there automatically connected to the radio transmitter which carried the voice to Mare Island, where it was clearly and distinctly received, and answers and other conversation were from there transmitted over the transcontinental line to the originating office in New York.

"The conversation was carried on by the president of the American Telephone & Telegraph Company, Mr. Vail; the vice-president, Mr. Bethell, and Mr. Waterbury, one of the directors, while at Mare Island were officials of the Navy Department, John J. Carty, chief engineer of the American Telephone & Telegraph Company, and representatives of the Western Electric Company.

"Every official taking part in this demonstration is enthusiastic about the results and the possibility of developing this system as an extension of the telephone system to ships at sea. The fact that the voices can be started on a land wire and automatically transmitted to a voice radio transmitter holds out hope that persons should readily be put in touch by telephone with others at sea through some central transmitting station.

"The use of such long distance wireless telephone communications in naval or military operations is still in an undeveloped state, but it is expected valuable use can be made of the wonderful demonstration; but aside from such considerations the department and its officials feel proud that they have been interested co-operators in the first practical development of this last march in the wonderful science of radio communication."

The space through which the oral message was transmitted is still in an undeveloped state, but it is expected valuable use can be made of the wonderful demonstration; but aside from such considerations the department and its officials feel proud that they have been interested co-operators in the first practical development of this last march in the wonderful science of radio communication."

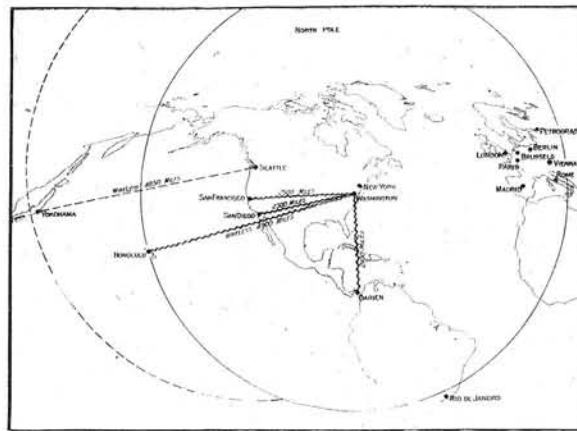

Radiotelephonic Range Chart, Showing How Speech Was Flung Through the Ether, 4,900 Miles From Washington to Honolulu, Corresponding to Distance Between Seattle and Yokohama.

fully transmitted by radio to Mare Island from Arlington, the return answers and communication being made over the transcontinental land telephone line. This was successfully accomplished in the presence of officials and engineers of the Western Electric Company, a representative of the

(Continued on page 369.)

Photographing Sound Waves Electrically

By Robert H. Moulton

The man who has had his troubles photographing an automobile traveling at the rate of 70 miles an hour, or about 100 feet a second, will best appreciate the difficulties faced by Prof. Albert F. Foley, of the University of Indiana, when he attempted to photograph a "sound wave." Yet Professor Foley successfully accomplished the feat and, what is more, his pictures were sharp and clear, which is something that cannot be said of most photographs of automobiles going at full speed.

To emphasize the greater obstacles overcome by his methods, it may be stated that photographs of racing automobiles are usually taken at a distance of 50 feet or more and the cars, of course, may be plainly seen, while the objects photographed by this scientist were only 2 feet away from the camera and are moreover invisible to the naked eye.

His method of photographing sound waves was suggested by the "twinkling" light of the stars, a phenomena caused by the light passing through air layers of varying density, due to varying temperature; in reality the light of the stars is absolutely constant. In like manner sound waves in air are waves of condensation

this shadow must not last longer than *one-millionth of a second*. Moreover, while the light does last, it must be a *thousand times* as strong as the light ordinarily employed in taking a photograph with a camera whose shutter works at a speed of one-thousandth of a second, and it must be turned on at *exactly* the right time or the sound wave will be out of range of the photographic plate.

Professor Foley arranged a large electrical machine capable of producing an almost continuous stream of electric sparks a foot or more in length, and each of such energy that is caused a loud report. In the circuit through which the sparks were to pass he made two spark gaps or breaks and in front of the first gap, nearest the electrical machine, placed his camera containing the photographic plate.

The action that results when a spark passes through the circuit may be described as follows: At the first gap the spark generates a sound wave directly in front of the photographic plate.

By the time that the sound wave has traveled outwards a few centimeters from the source the second or illuminating spark occurs at the second gap. The light

which show the waves in the process of being reflected from plane and curved mirrors, being brought to a focus by convex lens and made divergent by concave lenses, and, in fact, doing everything demanded by the sound wave theory.

The sound wave is produced by an electric spark gap S, which will be called the sound gap. The light is produced by a second spark at the illuminator gap I, which will be called the light gap. If the sparks at I and S are simultaneous the light I passes S before the sound wave emerges from behind the spark terminals. If the time interval between the sparks is any considerable fraction of a second the sound wave at S passes out of the field before the light from I reaches S. But when the interval between the two sparks is properly timed the sound wave at S casts its shadow on the photographic dry plate P.

The spark gaps S and I are connected in series to the spark knobs K, K₀, which receive sparks from T, T₀, the terminals of a large electric induction machine having four rotating mica plates 30 inches in diameter, driven by a variable-speed electric motor. The length of the spark gaps

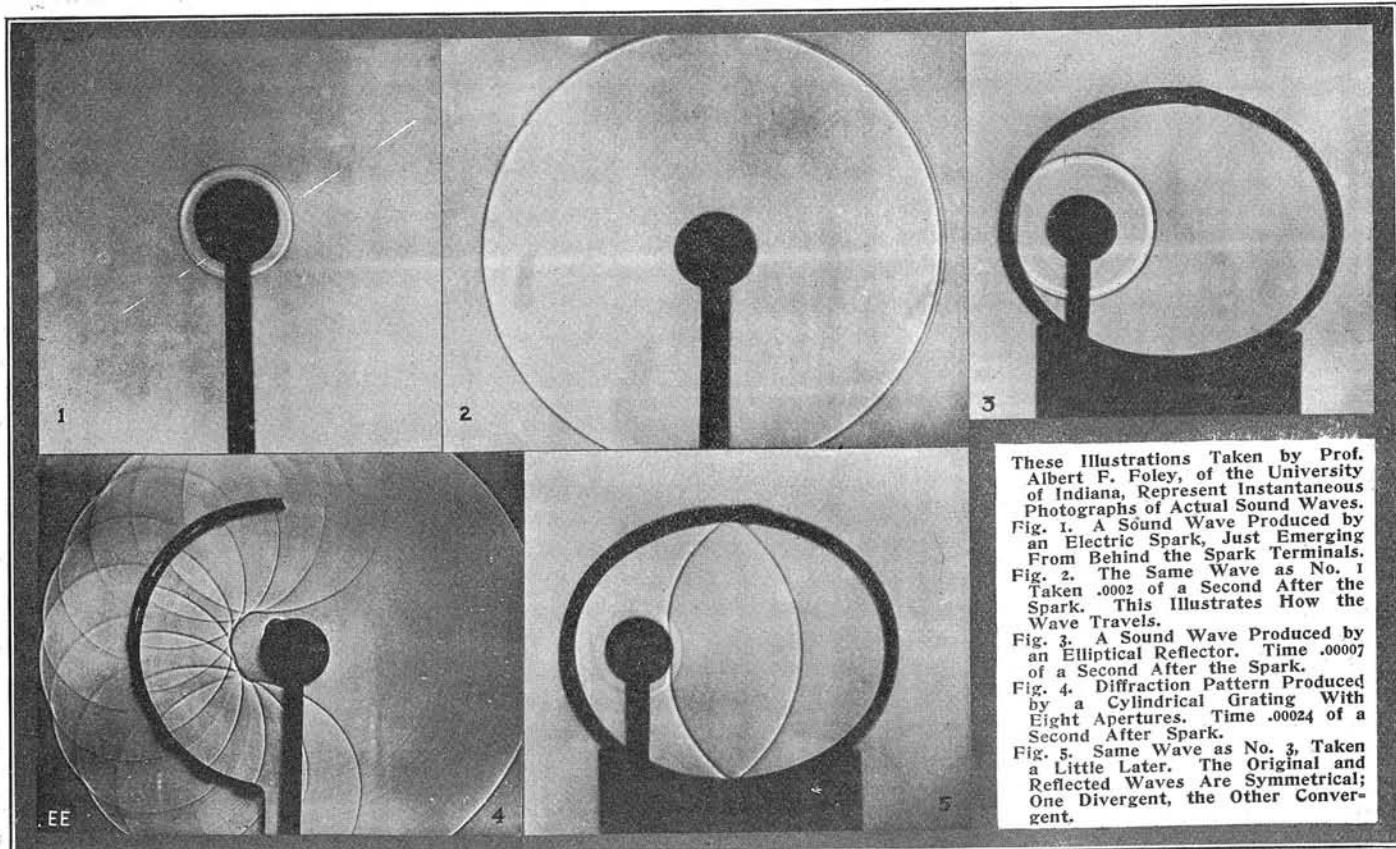

These Illustrations Taken by Prof. Albert F. Foley, of the University of Indiana, Represent Instantaneous Photographs of Actual Sound Waves.

Fig. 1. A Sound Wave Produced by an Electric Spark, Just Emerging From Behind the Spark Terminals.

Fig. 2. The Same Wave as No. 1 Taken .0002 of a Second After the Spark. This Illustrates How the Wave Travels.

Fig. 3. A Sound Wave Produced by an Elliptical Reflector. Time .0007 of a Second After the Spark.

Fig. 4. Diffraction Pattern Produced by a Cylindrical Grating With Eight Apertures. Time .00024 of a Second After Spark.

Fig. 5. Same Wave as No. 3, Taken a Little Later. The Original and Reflected Waves Are Symmetrical; One Divergent, the Other Convergent.

and refraction—that is, series of regions of varying air density. Since, then, the light from a star will be bent from its straight line path when it passes through such region, Professor Foley reasoned that sound waves produced between a point source and a photographic plate should cast shadows on the plate. The only thing necessary then is to photograph this shadow.

While this sounds simple and easy enough, it must be remembered that a sound wave travels at such great speed (or 1,125.69 feet per second at 20 deg. Centigrade) that in order to secure a sharp image of its shadow the light illuminating

from this spark is refracted as it passes the sound wave on its way to the photographic plate, thus throwing a shadow of the sound wave on the plate. To make the light of the illuminating spark sufficiently intense to give a clear image on the plate the electric charge is first stored in a large capacity of Leyden jars charged to a high potential, and then discharged between magnesium terminals placed in a glass tube like a short gun barrel, to direct the light, toward the plate. The details of this process are given below.

This physicist has a remarkable collection of these sound wave photographs,

T-K and T₀-K₀ is adjusted by sliding T and T₀ horizontally, or by moving K and K₀ vertically. Glass plates G and G₀, about 20 centimeters square, are fastened to a wooden bar on rod R, arranged so that it can be rotated on a horizontal axis. In the position shown in the figure the plates are directly between the spark knobs T and K and T₀ and K₀, thus preventing a spark. A quarter turn of the handle rod R removes the plates and allows the spark to pass. In practise, however, it was found best to make the spark gaps T-K and T₀-K₀ just long enough to prevent sparking when the glass plates are out of the field.

Rotating the rod then causes a spark just as the edges of the plates pass through the gaps.

To get a strong sound wave at S and an intense light at I, the sparks at the knobs K, K_0 should be heavy; consequently from one to three Leyden jars L_1, L_0 are put in multiple with each of the jars on the machine itself.

Most of the work is done with one additional jar connected to each of the machine jars. The knobs K, K_0 are connected to the gaps S and I through a large commutator C. Thus the direction of the spark at the gaps is readily changed. It was found that the apparatus worked about equally well with the spark in either direction. The chief effect of reversing the spark direction appeared to be a slight change in the time intervals of the sound and

light "sparks."

The sound gap S is in series with the light gap I, nevertheless the spark at S occurs before the one at I, because of the capacity K, which is in multiple with the gap I, as shown in the figure. The capacity K_1 consists of from two to eight Leyden jars of the usual type standing on

a sheet of tinfoil F, with one coating connected to earth. The time interval between the sound and light sparks depends on the capacity K_1 , the greater the capacity the greater the interval. However, it is not at all necessary to have here a variable condenser or one made up of small units. One can vary the capacity K_1 between

rather large limits and still keep the proper time interval by varying the circuit in other ways. The time interval is increased by decreasing the capacity L_1, L_0 ; by decreasing the length of the spark gaps T-K and T_0-K_0 . One can vary the capacity K by 100 per cent. and readily maintain an approximately constant time interval between the sound and light sparks by merely changing the length of the light gap. The length of this gap is adjusted by the lever arrangement L_1, L_0 .

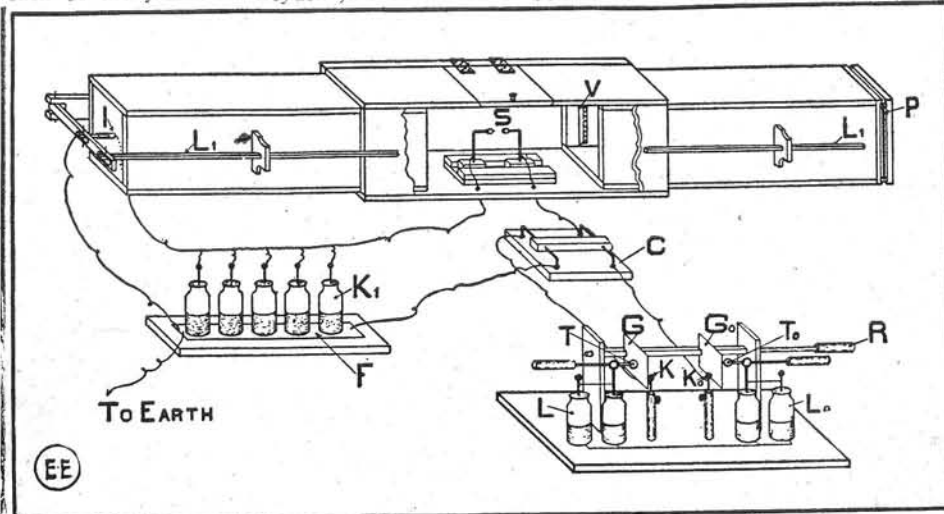

Layout of Apparatus Used by Prof. Foley in Photographing Sound Waves.

DANIELS NAMES NAVAL ADVISERS.

The make-up of the Naval Advisory Board of Inventions, the organization of experts who will contribute their inventive genius to the navy, of which Thomas A. Edison is to be the chairman, was announced by Josephus Daniels, the Secretary of the Navy, on Sept. 12 last.

The board will consist of 23 members, including Mr. Edison, who was selected by Mr. Daniels to serve as the presiding officer of the board.

The other 22 members of the board, who were chosen by ballot by 11 of the principal scientific societies of the country whose members deal with those branches of science on which the navy is thought to be dependent for invention, are:

W. R. Whitney, L. H. Baekeland, Frank Julian Sprague, Benjamin G. Lamme, R. S. Woodward, Arthur Gordon Webster, A. M. Hunt, Alfred Craven, Spencer Miller, William Le Roy Emmett, Matthew B. Sellers, Hudson Maxim, Peter Cooper Hewitt, Thomas Robbins, Howard E. Coffin, Andrew J. Riker, Henry A. Wise Wood, Elmer A. Sperry, William L. Saunders, Benjamin B. Thayer, J. W. Richards and Lawrence Addicks.

The first general meeting of the board was called on Wednesday, Oct. 6, in the office of Secretary Daniels in Washington.

In announcing the names of the members of the board Secretary Daniels made the following statement:

"Desiring to make available the latent inventive genius of our country to improve our navy, a short while ago I requested Mr. Thomas A. Edison to become chairman of an advisory board of eminent men who would make up the board. Mr. Edison, with the patriotism characteristic of American inventors, accepted the call to duty. The plan adopted for selecting the members of the advisory board was as follows:

"I requested 11 great engineering and scientific societies to select by popular election two members to represent their society on the board. The result has been most gratifying. I have received the nominations of all these societies and have accepted them, and it only remains to have a meeting, organize and determine the method of procedure in order to utilize to the best

advantage of our navy this mobilization of the talent and genius of our country. The response of the societies invited to co-operate in the great undertaking indicates the patriotic enthusiasm awakened by this call to duty."

Personnel of the Board.

These are the members selected by the societies and accepted by the Secretary:

American Chemical Society—W. R. Whitney, Schenectady, N. Y.; Massachusetts Institute of Technology, '90; director of research laboratory of the General Electric Co., where he has been the moving spirit in the perfection of metallic electric lamp filaments and the development of wrought tungstens. L. H. Baekeland, Yonkers, N. Y.; University of Ghent, '82; in private practice; founder of the Nepera Chemical Co., 1892, and inventor of photographic paper.

American Institute of Electrical Engineers—Frank Julian Sprague, New York City; Naval Academy, '78; consulting engineer for Sprague, Otis and General Electric companies; founder of the Sprague Electric Railway Motor Co. and concerned in establishing first electric trolley systems in the United States. B. G. Lamme, Pittsburgh, Ohio State, '88; chief engineer of Westinghouse Electric and Manufacturing Co. and a prolific inventor.

American Mathematical Society—Robert Simpson Woodward, Washington, D. C.; Michigan, '72; president of Carnegie Institution and an authority on astronomy, geography and mathematical physics. Arthur Gordon Webster, Worcester, Mass.; Harvard, '85; professor of physics of Clark University and an authority on sound, its production and measurement.

American Society of Civil Engineers—Andrew Murray Hunt, New York City; Naval Academy, '79; consulting engineer; experienced in the development of hydroelectric, steam and gas plants. Alfred Craven, New York City; Naval Academy, '67; chief engineer of Public Service Commission and formerly division engineer in charge of construction work on Croton Aqueduct and reservoirs.

American Aeronautical Society—Matthew Bacon Sellers, Baltimore, Md.; Lawrence Scientific School; director of Technical Board of the Aeronautical Society of

America, and first to determine dynamic wind pressure on arched surfaces by means of "wind funnel." Hudson Maxim, Brooklyn, N. Y.; ordnance and explosive expert and maker of first smokeless powder adopted by the United States Government.

The Inventors' Guild—Peter Cooper Hewitt, New York City; inventor of electric lamp appliances to enable direct current apparatus to be used with alternating current circuits, and devices for telephones and aircraft. Thomas Robbins, Stamford, Conn.; Princeton; president of Robbins Conveying Belt Co. and inventor of many devices for conveying coal and ore.

American Society of Automobile Engineers—Andrew L. Riker, Detroit; vice-president of the Locomobile Co.; electrical and mechanical engineer and inventor of many automobile devices. Howard E. Coffin, Detroit; Michigan, '96; vice-president of the Hudson Motor Car Co. and active in the development of internal combustion engines.

American Institute of Mining Engineers—William Laurence Saunders, New York City; Pennsylvania, '76; chairman board of directors of the Ingersoll-Rand Co. and inventor of many devices for subaqueous and rock drilling. Benjamin Bowditch Thayer, New York City; Harvard, '85; president of the Anaconda Copper Mining Co. and an authority on explosives.

American Electro Chemical Society—Joseph William Richards, South Bethlehem, Pa.; Lehigh, '86; professor of electro chemistry, Lehigh University, and author of numerous works on electro metallurgy. Lawrence Addicks, Chrome, N. J.; Massachusetts Institute of Technology, '89; consulting engineer for Phelps, Dodge & Co. and an authority on the metallurgy of copper.

American Society of Mechanical Engineers—William Leroy Emmet, Schenectady, N. Y.; Naval Academy, '81; engineer with the General Electric Co.; designed and directed the development of the Curtis turbine; first serious promoter of electric propulsion for ships. Spencer Miller, South Orange, N. J.; Worcester Polytechnic, '79; inventor of ship coaling apparatus and the breeches buoy device used in rescues from shipwrecks.

(Continued on page 364.)

Some New X-Ray Apparatus

SEVERAL new X-ray apparatus have been recently developed and perfected whereby the efficiency of this electrical aid to surgery and medical men has been vastly increased. A number of these up-to-date X-ray apparatus will be described in this article.

One great difficulty in the generation of high voltage currents by an induction coil

inating gas for a quenching dielectric is depicted in Fig. 1. This particular interrupter consists of a small rotary pump, which throws a stream of metallic mercury against contact segments. The arc which is formed upon the break at the contacts is quenched by the gas, which is sent through the chamber. A condenser, of suitable capacity, is shunted across the interrupter terminals. The number of breaks per second can be regulated by varying the speed of the motor and also by the adjustment existent between the rotary and stationary segment.

A highly efficient heavy current chemical transformer (really an electrolytic rectifier) is portrayed at Fig. 2. This constitutes an ordinary rectifier of this class, employing extra large iron and aluminum plates immersed in an electrolyte of sodium phosphate (or bicarbonate of soda may be used).

These chemical transformers can be satisfactorily employed in places where direct current is required, when A. C. is supplied from power companies' mains.

These large rectifiers are inserted in the primary circuit of large (3-5 kw.) X-ray transformers to clip off half the cycle waves of the alternating current and thus produce in the secondary circuit a unidirectional or direct current of high potential. In other words, the negative pulses of current in the primary circuit are clipped off by the rectifier and pulses of positive current only are allowed to pass through the transformer. This does not give a true unidirectional or D. C. in the secondary, but by interposing high potential rectifier tubes in the secondary circuit before the current reaches the X-ray tube the much-desired high tension direct tube current is approximately developed. In the large machines pure direct current at 100,000 volts is produced by a revolving commutator of special design.

Another problem met with in the continuous production of X-rays is the gen-

erating tube itself, which becomes extremely hot when operated for periods of several minutes or even seconds; this is mainly due to the rapid ionic bombardment acting on the Anode electrode. Various shapes and sizes of Anodes and tubes were

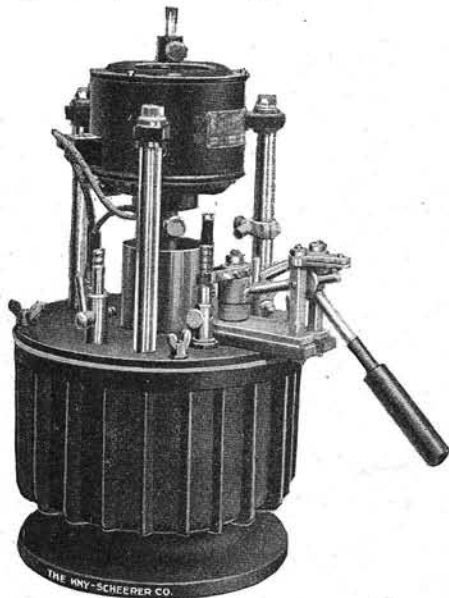

Fig. 1. Improved Type of Mercury Jet Interrupter.

or transformer for X-ray requirements lies in the device which produces the current interruptions when operated on direct current. Various types of interrupters have been built for this purpose, but none of them have proved very efficient. One of

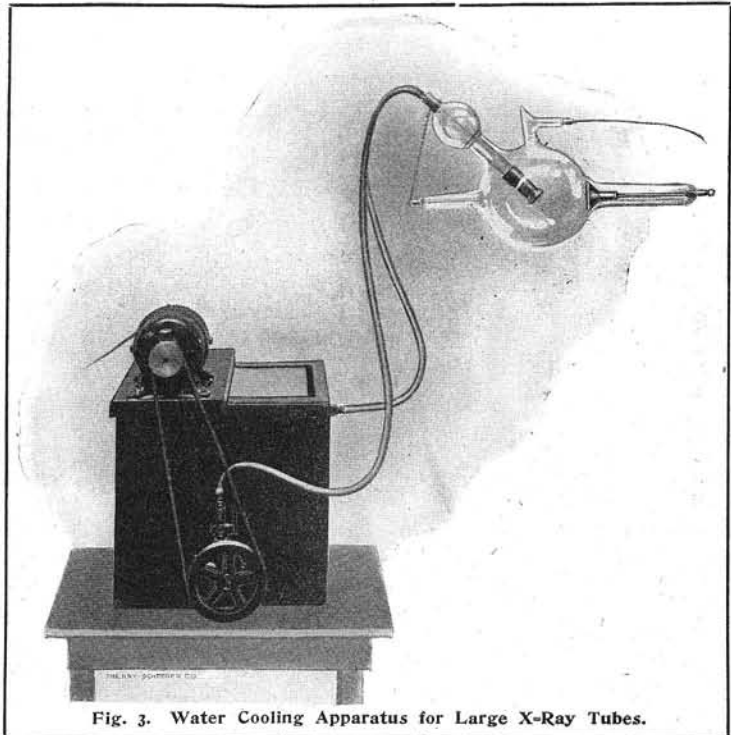

Fig. 3. Water Cooling Apparatus for Large X-Ray Tubes.

made to help eliminate this defect, but none of them have proven very beneficial, until the water-cooled Anode tube was devised. This is illustrated in Fig. 3, together with its water circulating apparatus. This consists of an electrically-driven pump built into a large water tank, to which two rubber tubes are connected from the tube, one for feeding in the water and the other for discharging it.

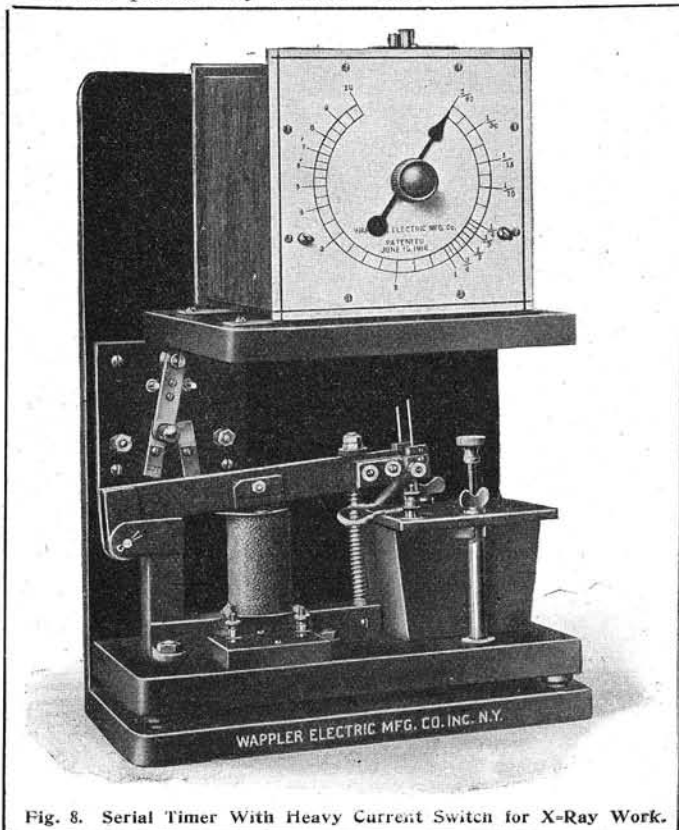

Fig. 8. Serial Timer With Heavy Current Switch for X-Ray Work.

the latest interrupters of the improved mercury jet type and which employs illum-

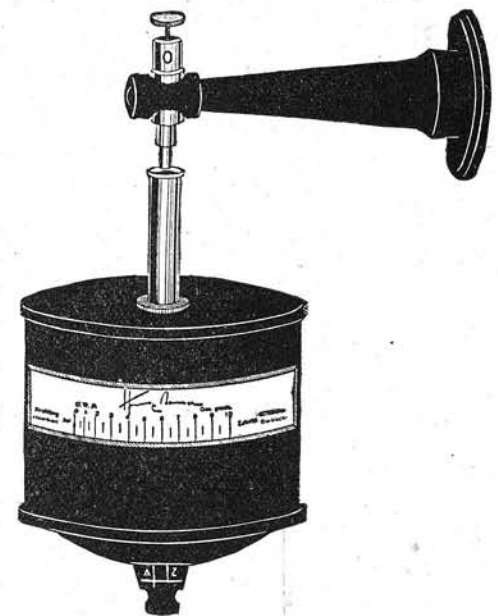

Fig. 5. Electro-Static Type of X-Ray Penetrometer.

In this way the Anode is constantly cooled by the circulating liquid. This scheme has showed remarkable results in allowing the tube to be manipulated for several minutes,

at full load, which often means 15 to 25 kilowatts.

A recent very neat instrument has been designed whereby the penetration of the X-rays through silver is taken. It is well known that these rays do not penetrate this metal appreciably and consequently a "meter" for measuring the penetration of X-rays has been invented. It is shown in Fig. 4, and is called technically a "Penetrometer." This instrument consists of a standardized tapered piece of silver, mounted on a lever which is movable in front of a fluorescent screen by means of a rack and pinion operated by a small knob in front of the instrument. A small graduated aluminum scale is provided so as to show exactly the penetration of the particular X-ray measured. The distance between the tube to be tested and the Penetrometer, at which readings are taken, is immaterial, as the radiance at a given distance has an even influence through the silver and aluminum; however, as a rule 12 inches from the wall of the tube allows the quickest readings. Another instrument for measuring the penetrating power of the rays is depicted in Fig. 5, but this is graduated in different units and is operated by a single wire, connected to the cathode terminal of the high tension machine. This is a different instrument than the one previously described, as the former depends upon the secondary voltage produced by the transformer. Inasmuch as the penetrating power of the tube depends upon the voltage, this instru-

skiagraphic pictures which have been taken with different X-ray tubes. Fig. 6 shows the bare foot of a woman. Note the won-

derful clearness of the bones and the fibrous structure of same; while Fig. 7 portrays X-ray photo of the right foot of a man, with shoe on, as will be readily perceived. Note the appearance of the skin of the foot in comparison with the leather of the shoe. Also observe the nails, the arch, lace tips and eyelets. This picture was taken with a $\frac{3}{4}$ second exposure; distance between tube and plate was 18 inches, while the tube was carrying 40 milliamperes of high potential direct current. The latter skiagraph was taken by Harry F. Ernest, the expert radiographer of the Kny-Scherer Co.

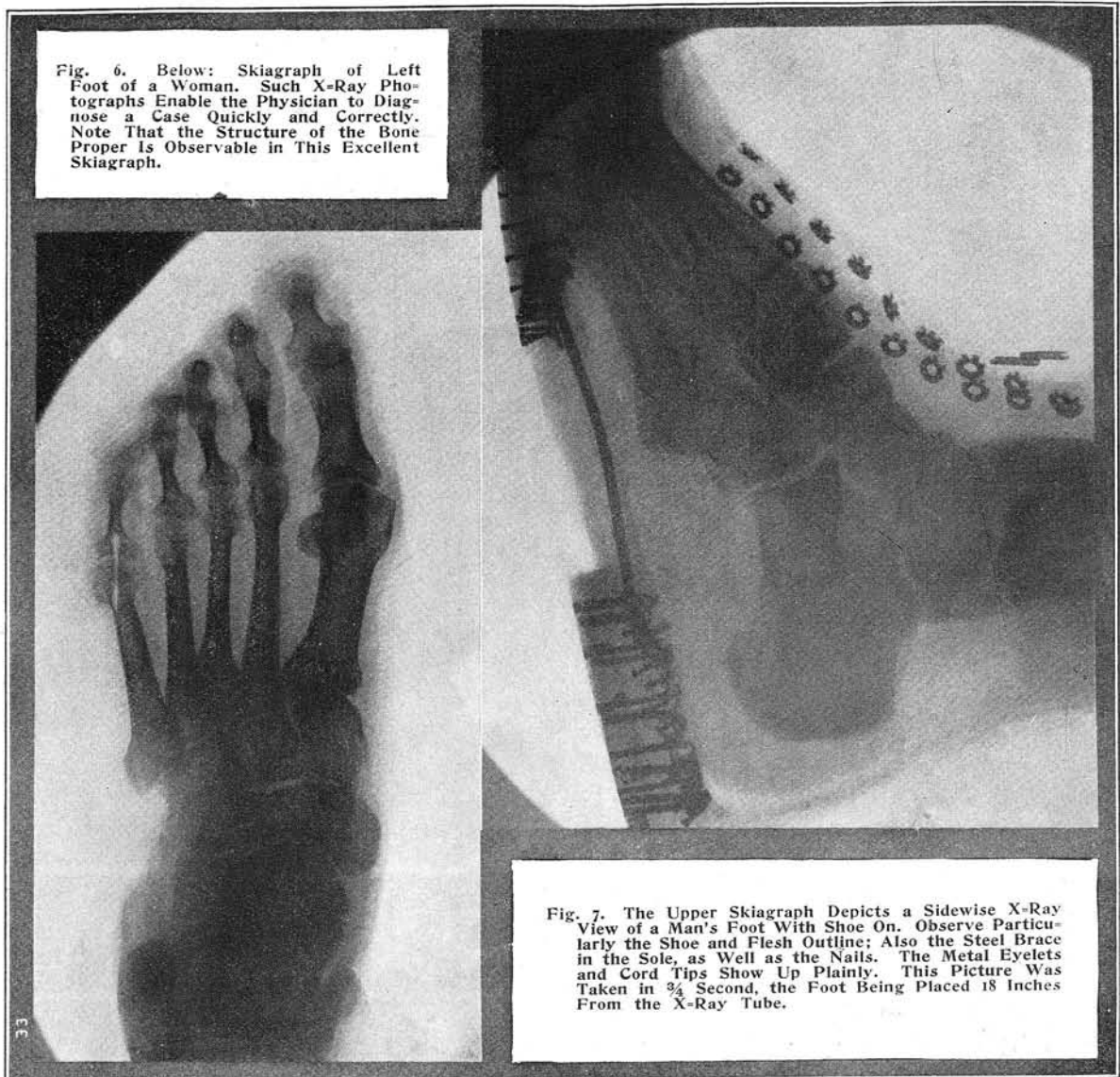

Fig. 6. Below: Skiagraph of Left Foot of a Woman. Such X-Ray Photographs Enable the Physician to Diagnose a Case Quickly and Correctly. Note That the Structure of the Bone Proper Is Observable in This Excellent Skiagraph.

Fig. 7. The Upper Skiagraph Depicts a Sidewise X-Ray View of a Man's Foot With Shoe On. Observe Particularly the Shoe and Flesh Outline; Also the Steel Brace in the Sole, as Well as the Nails. The Metal Eyelets and Cord Tips Show Up Plainly. This Picture Was Taken in $\frac{3}{4}$ Second, the Foot Being Placed 18 Inches From the X-Ray Tube.

derful clearness of the bones and the fibrous structure of same; while Fig. 7 portrays X-ray photo of the right foot of a man, with shoe on, as will be readily perceived. Note the appearance of the skin of the foot in comparison with the leather of the shoe. Also observe the nails, the arch, lace tips and eyelets. This picture was taken with a $\frac{3}{4}$ second exposure; distance between tube and plate was 18 inches, while the tube was carrying 40 milliamperes of high potential direct current. The latter skiagraph was taken by Harry F. Ernest, the expert radiographer of the Kny-Scherer Co.

The illustration at Fig. 8 is of a new X-Ray serial timer, which will be found very useful to the medical profession engaged in making numerous skiagraphs. The timing of such X-Ray photos is very important. The dial indicator of this new instrument may be placed on any exposure time from $\frac{1}{60}$ of a second to 10 seconds.

The Repeating Serial Timer is made up of an actuating mechanism which permits a pair of contacts to close an electric circuit through a magnet, and remain closed for a predetermined length of time, this being accomplished by the magnet pulling a pair of large contact surfaces together,

magnetism collapses and the large contacts

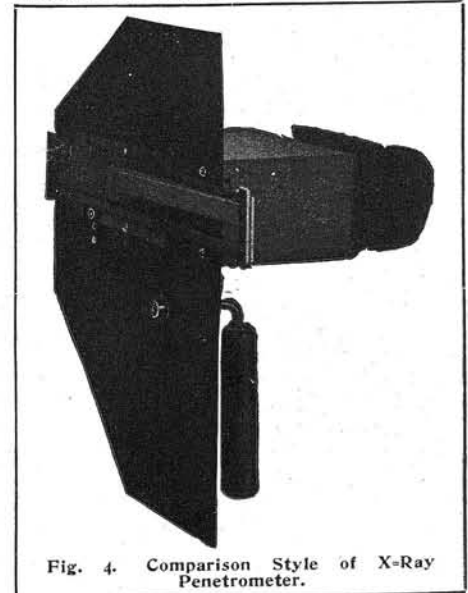

Fig. 4. Comparison Style of X-Ray Penetrometer.

are separated by a strong spiral spring

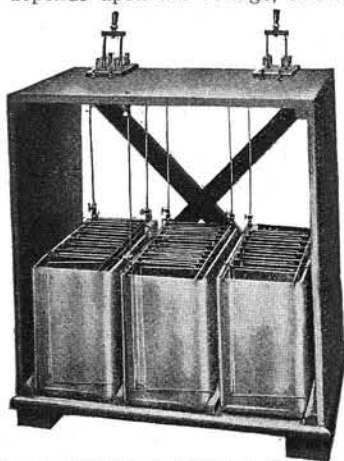

Fig. 2. Chemical Rectifier Capable of Handling Several Kilowatts.

ment will show exactly the penetration of any particular X-ray tube.

We present two exceptionally good

READING ELECTRIC METERS WITH A CAMERA.

The truth-telling camera has found another and highly practical field of usefulness. Electric meters, gas and water meters will in future be photographed instead of read and in place of figures furnished by sometimes very fallible inspectors a film record will supply authentic confirmation of the charge. This method of reading will also be much quicker and, with all possibility of error removed, a great saving in the time of inspectors and clerks as well as of consumers over disputed accounts will be effected.

A camera for the purpose has just been invented by the Eastman Kodak Co., and is known as the "Factograph." This novel camera is oblong in shape, measuring $4\frac{1}{2} \times 5\frac{1}{4} \times 12\frac{1}{2}$ inches—is made from selected mahogany, is equipped with a high grade anastigmat lens working at f.6.3 and a simple automatic shutter permitting exposures varying from $\frac{1}{5}$ to $\frac{1}{2}$ a second—within the judgment of the operator.

The camera is made in two compartments—the forward compartment being an electrically lighted chamber with an opening that fits over the meter dial. The reading is made by simply placing this opening against the meter and pressing downward on the exposure lever.

This one action automatically turns on the light, opens and closes the shutter and turns off the light. The shutter with each exposure locks automatically and remains locked until film for the next exposure has been wound into place, when it again flies automatically back to the "set" position.



Sample of Film Record as Taken by New Electric Meter Camera.

This prevents the possibility of a double exposure—likewise there can be no blanks,

for the film cannot be wound off until the exposure is made. Winding reel and shutter are automatically unlocked. This eliminates the possibility of error from forgetting to turn the key or from turning the key before the exposure is made. The light

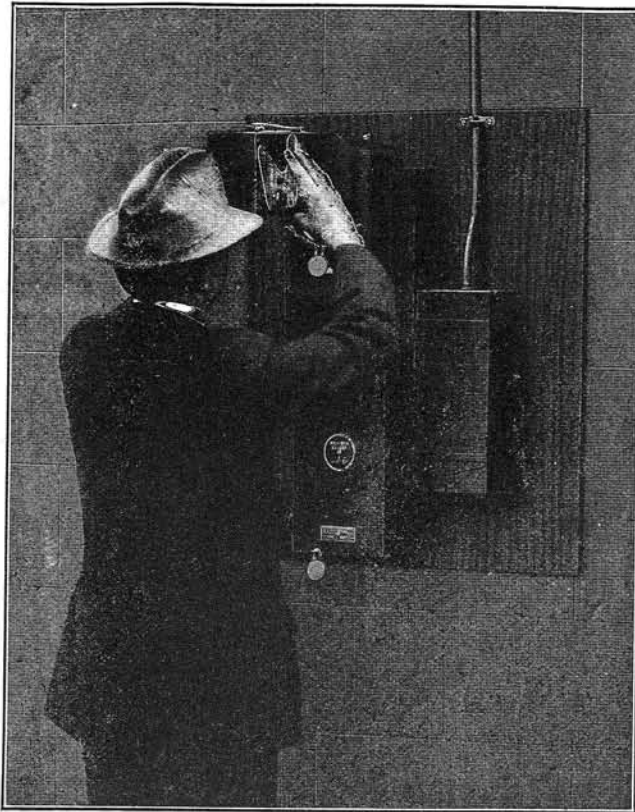

How the New Electrically Lighted Meter-Reading Camera is Used.

is furnished from two four-cell dry batteries stored on either side of the camera and supplying current to four 3.8 volt Tungsten miniature lamps.

The exposure is recorded upon special, sensitized paper; a special film or paper is supplied in the familiar cartridge form and is daylight loading—each cartridge carrying 75 exposures.

Storage space for two extra rolls is provided in the dark chamber of the camera in addition to the roll in position, permitting 225 readings to be carried within the body of the camera. A small drawer is provided in front which carries six extra lamps.

By pressing a small button which is located just below the exposure lever the lights may be turned on and the camera converted into a "flasher" for locating meters or finding one's way through dark cellars.

Special developer, furnished for the purpose, makes it possible to develop the film in 45 seconds. It is then ready for the reading by the bill clerk. No printing is necessary. The spools of film are opposed to a tiny mirror reeled up like a movie film, the clerk copying the records as they are mirrored. Identification of each meter is made possible by attaching the name and number to the meter. These are photographed with the meter reading.

In residence sections, through absence of the household, inspectors are frequently unable to gain access to the meters on the first call. For such contingencies cards are provided with the word "out" printed upon them. This card is photographed in place of the meter record and the information appears on the film in its proper order.

MISHAPS ATTEND USE OF WIRELESS ON AEROPLANES.

It has already been noted in many official and unofficial despatches that wireless telegraphy is frequently used both by the Royal Flying Corps and the Royal Naval Air Service. Most people are used to seeing wireless apparatus, which, whether used on board ship or on land, includes a series of long wires strung between masts or attached to a long pole in the ground.

These generally take the form of a single long wire on aeroplanes, which, when not in use, is wound up on a reel like the reel of a fishing rod, inside the machine. When it is intended to operate the apparatus the aerial is let out, the initial impetus being given to it by a lead weight like a plumb bob attached to the end.

Several hundred feet of this wire are let out, and it assumes a most curious shape in the air, because the weight of the plumb bob and of the lower portion of the wire naturally endeavors to hang down straight, whereas the resistance of the air through which the aerial is dragged always tries to pull it out horizontally behind the machine, with the result that the wire assumes a curve stretching out some distance behind the machine itself, says the editor of *The Aeroplane*, London.

When several hundred feet of wire are out, the air resistance actually amounts to quite a considerable strain on the reel, and consequently on the machine itself, though it is generally attached so that it does not interfere to any considerable degree with the fore and aft or lateral control of the machine. If, however, the engine stops suddenly, and the pilot has to make a forced descent, his operations are occasionally complicated by the resistance of the wire, which then is apt to act something like a brake on the machine's gliding path downward, unless it can be wound up fairly quickly.

In one case an officer who was experimenting with wireless as a passenger on a machine so fitted was quite badly knocked about owing to the necessity for winding in the wire. He was quite an experienced flyer, and had made a study of the best way to behave in case of an accident. In several such cases he had come out unhurt by the simple process of tucking his feet up onto the seat and rolling himself up as nearly into the shape of a ball as possible, so that when the machine turned head over heels he went over with it and his feet were not trapped by the front part of the machine breaking back on top of them.

In this particular instance he was so full of his duty that he went on winding away at the reel till the machine actually struck the ground. He had been obliged to steady himself with one foot against the floor of the front of the machine and wind up the reel on the left-hand side of the machine with his right hand. Consequently when the machine struck he pitched with all his weight onto his foot and was flung forward with his right arm against the front of the bodywork, the resulting damage being a broken leg and a broken arm. He has since concluded that under similar circumstances it is wiser to let the wire alone when he is near the ground and hope that it will catch in a tree or a hedge and break.

MASSIVE ELECTRIC GENERATOR HOLDS AUTOMOBILE.

The illustration shown herewith depicts an extra large electric dynamo built for one of the great automobile factories in Detroit. The massive size of this dynamo can be judged by the picture, which illus-

trates one of this concern's automobiles resting nicely on a scaffold in the center of the stationary field frame of the generator. This is one of several similar generators which will supply the current for the entire plant turning out these motor cars.

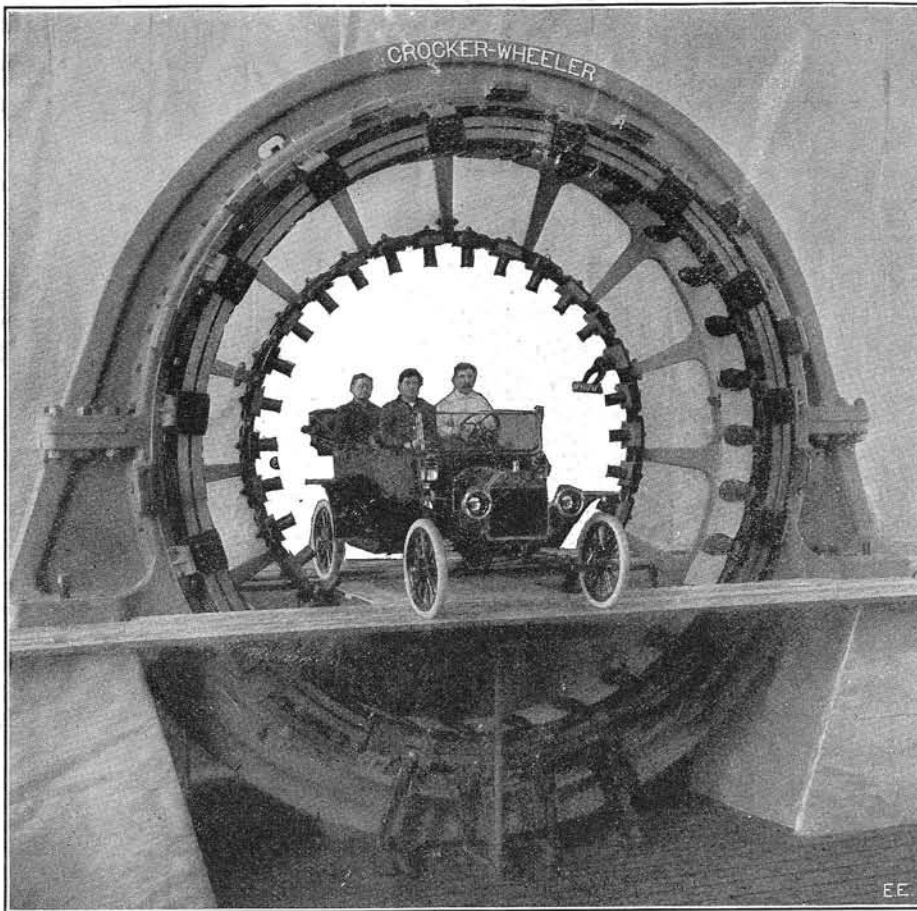

Huge Electric Generator Accommodates Automobile Within Its Field Frame.

MIND-READING DOG IS A PUZZLE TO SCIENTISTS.

DECLARED by Western scientists to be one of the most remarkable dogs on record, Hector, a little French poodle, owned by C. J. Tryon, a mining engineer, of Arizona, has opened the eyes of students of psychology to new possibilities of the animal mind. Only two years of age, this dog has been trained not only to add, subtract, multiply and divide, but also to read the mind of his master, this being done, as explained by Professor C. L. Edwards, head of nature study work in Los Angeles schools, by the joint powerful concentration of both dog and man.

Numerous demonstrations have satisfied skeptical ones that there is no trick connected with the evidence of the dog's mental development, and investigators have come away with the conviction that, properly trained, the dog is a wonderful thinking and reasoning animal.

It was through reading an article by Maetterlinck, on the scientific mental training of horses in Germany, that Mr. Tryon conceived the idea of experimenting with the poodle he purchased in Los Angeles. He began by teaching the animal ordinary balancing tricks, and then finding Hector not only attentive and obedient, but a remarkably apt scholar, began to devote his time to the dog's mental training. It required patient drilling, but the results astounded him, for in a short time Hector was not only able to grasp the meaning of

more than one hundred words and to obey their command with the proper action, but he showed evidence of being able to carry more than one idea or thought in his mind at the same time. "Hector, roll over!" Mr. Tryon would command, and Hector would proceed to do so. Then his master would order him to "roll over, sit up, shake your paws and bark," and after a little drilling the dog would perform all acts in their proper sequence. Once learned, an act, mental or physical, was never forgotten.

The dog's mathematical ability came merely as a matter of learning to distinguish and to apply on command the words "one," "two," "three," and so forth, just as he had learned to distinguish between "sit up" and "roll over," or between "pull it over" and "push it over." At the command "Count one!" Hector would be shown to tap a bell with his paw, once. At first the word "one" meant nothing, but after being stopped on the first ring of the bell he soon took note

and tried to catch the word. At "Count two!" he would have to strike the bell twice, and these commands would be repeated until he mastered them.

Then came the combinations, "two plus two." It required patient, laborious effort on the part of his teacher, but gradually the little poodle learned to tap the answer for any plus combination that did not exceed twenty-five in total. Whenever he erred on any particular combination he was corrected immediately, and made to tap the right answer several times in succession, after separate commands, before any further progress was attempted. Hector simply learned that the command "Count two plus seven!" meant nine taps of the bell, just as he had learned that "sit up" and "roll over" meant a certain act on his part.

Mr. Tryon explained some of his methods and the success he has met with as follows:

"To start with," he said, "Hector has perhaps no more wonderful brain than a great many other dogs, but he has had the advantage of scientific training. From observations and experiments I had long become convinced that dogs could think and reason, and I was determined to prove it. Finding Hector, like most poodles, very attentive and ready to concentrate his whole thought on every word spoken, I put forth every energy in his mental development. It became a hobby of mine, and I thoroughly enjoyed what would perhaps tax the patience of the average man.

"Physiological experiments prove that the principal parts of a dog's brain are relatively located and have the same function as the human brain. Like humans, different dogs have certain well defined talents which can be developed to a remarkable extent by continued training, providing, of course, that the dog has real brain capacity. Some humans cannot learn anything, and some dogs are the same way—naturally without brain capacity."

Recently Mr. Tryon has discovered that his French poodle has a remarkable faculty for reading his thoughts. Not being a student of mental telepathy, Mr. Tryon is at a loss to explain it, but on many occasions he has concentrated his thoughts on a certain number and, fixing his gaze on Hector, has silently commanded him to



"Hector," the Dog That Taps an Electric Bell Intelligently, It Is Said.

"count" that number. And Hector has invariably approached his tapping bell and counted the number correctly.

High Frequency Currents and Apparata

EVER since 1891, on which memorable date Nikola Tesla, the wizard of high frequency electrical phenomena, delivered his famous lecture before the American Institute of Electrical Engineers covering his discoveries and experiments in

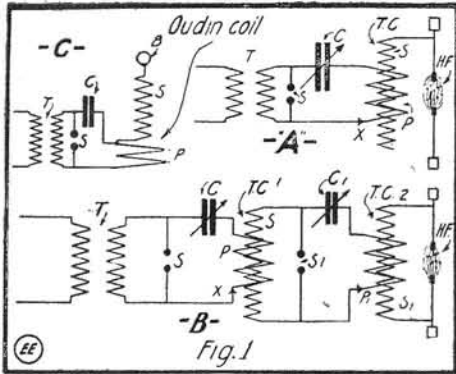

Fig. 1. Diagrams For Oudin and Tesla Coil Hook-Ups.

this wonderful field of science, the greatest scientists of the whole world have been busily occupied in developing and perfecting apparatus of this nature for various purposes, including invaluable electro-therapeutical applications, wireless telegraphy, etc. Possibly the electro-medical profession has benefited more by the discoveries in this little known field of electrical science than any other branch of workers.

In this article will be outlined a few of the more interesting arrangements and types of apparatus which can be employed for the production of ultra-high frequency, high potential electric currents, and which, as is generally known, can be taken through the body without feeling any appreciable pain. It is these high frequency currents, which oscillate at anywhere from 100,000 up to 1,000,000 or more times a second, which are utilized in the many electrical stage acts touring the country and which probably most readers have seen at some time or other. The apparatus described in this article produces high frequency currents of this character, and many pleasing, startling experiments can be made therewith, similar to those shown by the stage lecturers and college professors.

At Fig. 1 there are outlined at A, B and C the principal hook-ups and layouts of apparatus necessary for the production of these ultra-high frequency currents. At Fig. 1A is depicted the regular Tesla coil circuits with a step-up transformer, T, spark gap S, glass or other high tension

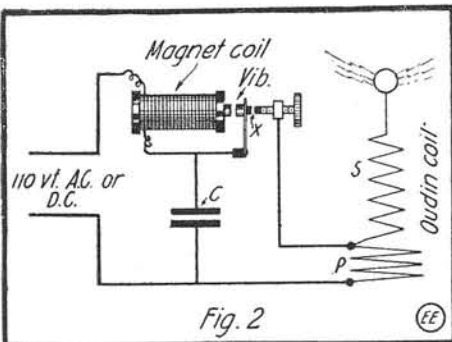

Fig. 2. Collins-Sanchez High Frequency Generating Circuit.

condensers C, preferably of the adjustable type, and TC the air-core Tesla transformer. At P the primary of this Tesla coil is indicated, while at S is shown the

secondary winding. The high frequency current discharges take place between the electrodes at HF. To properly tune the closed oscillating circuit SCP the condenser C should be made adjustable as aforementioned, and also the primary inductance P should be variable by means of a clip X. This permits the capacity and the inductance of this circuit to be altered until maximum results are obtained in the Tesla coil secondary.

In some cases resort is had to a compound Tesla circuit as depicted in Fig. 1B. Here the usual step-up transformer excites the circuit SCPX. The secondary S of Tesla coil TC¹ then charges or excites the second closed oscillatory circuit S¹C¹P¹, the final high frequency discharge taking place from the secondary S¹ of the No. 2 Tesla coil.

Where a discharge of great intensity is desired the usual hook-up for a high frequency outfit is indicated at Fig. 1C. Here the same symbols refer to similar parts as just explained, and for this Oudin coil arrangement one end of the secondary S is joined to the primary coil P; the other end of the secondary coil is connected to a brass or copper ball B. This scheme is

former P. The vibrator X carries extra heavy silver contacts and the iron armature of the vibrator spring is attracted by the magnet coil as perceived. Thus this vibrator performs two functions, viz., it serves to interrupt its own (magnetic coil) circuit as supplied with current from 110-volt direct current or alternating current, and also it serves as a spark gap for the high frequency oscillating circuit CXP. These high frequency currents thus produced are transformed by induction into the secondary circuit of the Oudin coil S. This type of apparatus gives a very powerful and steady uni-polar discharge, and the current thus generated is much in use nowadays for ultra-violet ray treatment, excitation of X-ray tubes, etc.

A great many experimenters possess a high voltage wireless transformer rated at 1/2 kw. or more and giving anywhere from 12,000 to 15,000 volts at the secondary terminals. For those possessing such a transformer, and also for those who may be interested in building a fair-size high frequency outfit and who can easily purchase a suitable transformer of the size aforementioned, the following data is suggested. The Tesla coil here described will produce

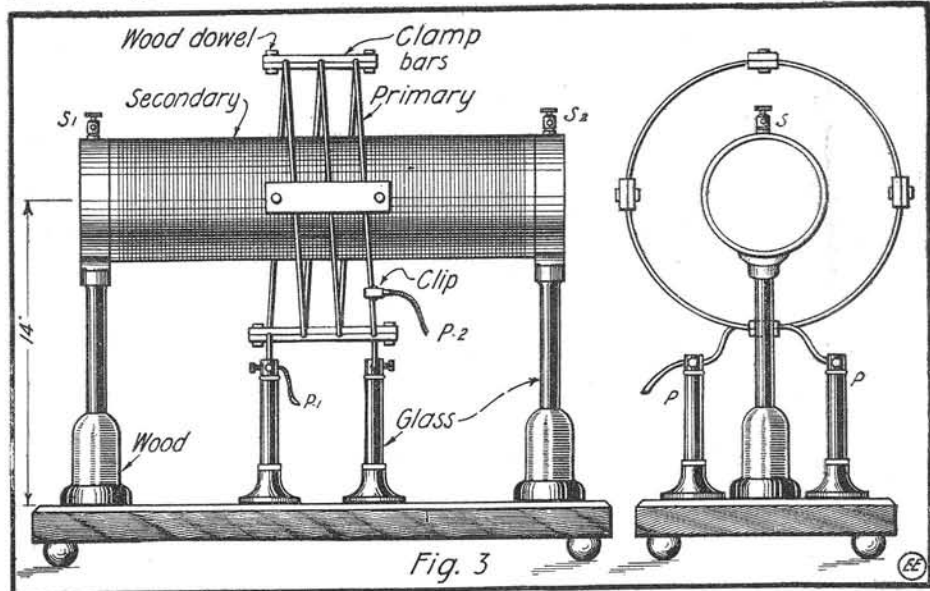

Fig. 3. A Well Designed Tesla Coil, Suitable for Use on 1/2-Kw. High Potential Transformer.

different from those shown at A and B, Fig. 1, in that the secondary is placed at the end of the primary and not inside of same, as is the case in the regular Tesla coil arrangement.

While on the subject of high frequency schemes and circuits for same, it will undoubtedly be of interest to cover one of the latest plans for this kind of work, or the Collins-Sanchez high frequency generating circuit, as outlined in Fig. 2. This constitutes the idea now utilized in a large majority of the extra compact style high frequency sets supplied for physicians' requirements, etc. To begin with, a small-size and very well-insulated Oudin coil consisting of primary and secondary P and S is made use of. The secondary, as understood from diagram at Fig. 1C, connects to a metal ball or other electrode as observed, and its other free terminal is joined to the primary P. High frequency currents are caused to be generated and to oscillate around the circuit CXP, which comprises a mica or other fairly high voltage condenser C, a vibrating spark gap X and the primary coil of the Oudin trans-

12 to 15-inch high frequency sparks from the secondary when excited by a transformer of the type just mentioned.

Besides the transformer in question, there will also be required a suitable glass plate condenser or the equivalent made up of Leyden jars, and also a spark gap, which shall preferably be of the rotary type so as to be well cooled. A quenched spark gap proves very efficient for this class of work.

Fig. 3 shows the appearance of the Tesla coil design here proposed. The base of same may be made of some well-dried wood, and this had best be boiled in paraffine wax so as to exclude all dampness. Upon this base are placed glass supporting rods for the secondary and primary coils, and this will be found to give the very best efficiency where such high frequency, high potential currents are to be produced.

The primary coil is composed of four to six turns of about No. 4 B. & S. copper, brass or aluminum wire (stranded best), and these convolutions of heavy wire are wound to a diameter of about 12 1/2 inches, spacing the turns about 1 1/2 inches apart.

The primary turns are held in shape by four wax impregnated wooden clamps, as perceived. Also a clip is provided for one lead of the primary so that the number of turns in circuit, and consequently the inductance, may be varied in tuning up the set.

The secondary coil may be composed of a cardboard cylinder 24 inches long by 5 inches in diameter. This is provided with two binding posts at the end of same, as shown, and the winding comprises one even layer of No. 26 enameled or silk-covered magnet wire, each turn being spaced from its neighbor the thickness of the wire itself to improve the insulation. This can be done easily in a screw-cutting lathe.

This coil should be hooked up as per diagram, Fig. 1A. Regarding the glass plate condenser suitable for this 1/2-kw. size high frequency coil, and considering that the exciting transformer is rated at 12,000 volts (secondary), with a frequency of 60 cycles, then .06 microfarads condenser capacity is required. If 1/8-inch common glass is used in making this condenser about 5.333 square inches of such glass is required. This is coated on both sides with tin-foil; 1 1/2 inches margin should be allowed around every tin-foil leaf on the glass plates. If the foil can be

to the condenser frame as in diagram, i. e., to opposite end of the metal strips, so that the high frequency inductance will be balanced, no matter how many condenser plates are in use. The number of plates in use can be varied by simply sliding them out of the rack, or also by removing one or more of the spring contact shoes.

Regarding the details of rotary spark gap suitable for this outfit, they are illustrated at Fig. 5. Any small motor operating on battery or 110-volt current is to be utilized in driving the rotary spark disc B. This disc is made up in the regular fashion as employed for wireless sets, but the plan here advocated is a very good one, especially from the air-cooling point of view.

This design calls for a 1/8-inch zinc or other metal disc about 6 inches in diameter, and 12 spark plugs are cut into the disc as detail sketch B portrays. These sparking electrodes are cut on three sides and then the lug is bent up. All of these lugs when finished should be filed off or turned off in a lathe, so as to be perfectly true. This operation, however, had best be postponed until the disc is firmly screwed or riveted to a central hard rubber insulating hub, as drawing shows. The spark disc is held securely to the motor shaft either by means of a regular hub or by means of

tenser and primary coil clip X should be adjusted one after the other or alternately until the maximum resonance is obtained in the circuit as manifested by the produc-

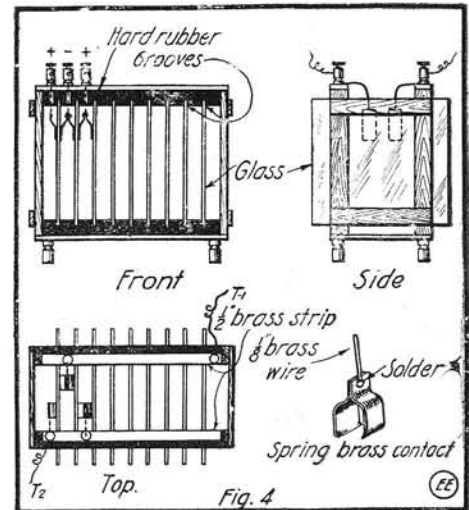

Fig. 4. Constructional Details of 12,000-Volt Glass Plate Condenser.

tion of the largest spark in the secondary circuit.

There is appended to this article a short bibliography of the more important articles which have appeared in *The Electrical Experimenter* on high frequency currents, and also a number of the best books available on the subject.

For those vitally interested in this subject it will be well to purchase one or more of the books mentioned. A few experiments of general interest are cited below.

An experiment not very well known, although dating from the time of Tesla's first lecture on high frequency currents, is that which demonstrates how a motor may be operated on one wire, and in some cases without any wires connected to it. Upon this and other experiments employing very powerful currents Tesla has taken out a number of patents on the *wireless transmission of energy* through space.

At Fig. 6 is depicted Tesla's scheme for a one-wire motor. One terminal of a small-size high frequency Tesla coil is hooked up to a coil of wire wound on an iron core and in front of which is placed a delicately mounted metal disc, which can rotate upon its axis as perceived. The other end of the magnet coil is connected to a metal plate suspended in the air and which picks up energy out of the ether, presumably. When the Tesla coil is excited in the usual way the high frequency

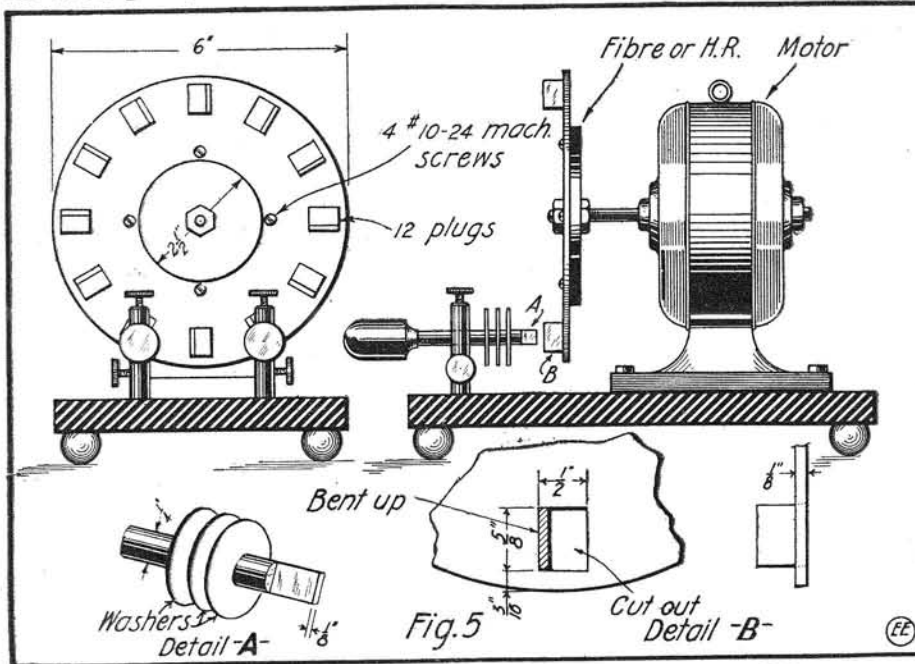

Fig. 5. Details of Rotary Spark Gap for 1/2-Kw. High Frequency Coil.

made 24x20 inches on each plate, then 11 such plates will be necessary for this outfit.

At Fig. 4 are shown a number of details which can be followed more or less exactly in making up a suitable condenser rack to hold these glass plates. This rack may be made up of wax impregnated wooden pieces, and inside of same there are placed two hard rubber strips in either side of the frame, which strips are slotted as perceived, so that the glass plates may rest edgewise in these slots, thereby reducing current leakage to a minimum. By looking at the top view of the condenser frame it is seen that two metal strips run along the top hard rubber strips and a series of binding posts are mounted on these metal pieces. From each binding post there runs down between the glass plates a brass wire carrying a spring contact shoe, detail of which is shown in sketch at Fig. 4. It is thus perceived how each alternate foil-leaf on the glass plates receives a positive and negative charge. The terminal lead wires T1 and T2 should be hooked up

hexagon nuts threaded onto the shaft. In front of the revolving spark wheel are mounted two stationary electrodes, and detail sketch A shows how the ends of these are filed down so as to correspond with the thickness of the rotating disc electrodes. It is well to force a few cooling vanes (washers) tightly on the ends of the stationary electrodes as indicated. A marble base is best employed for mounting the motor and stationary electrodes with their upright standards. There are thus two spark gaps in series in this design. It is well to have a rheostat in series with the spark gap motor, so that the speed of same may be adjusted, and also the spark frequency, in tuning up the complete high frequency sets.

When all of these parts have been properly made up or assembled and the diagram followed as per Fig. 1, there should be very little trouble experienced in producing a heavy high frequency spark 1 foot long or more, depending upon the adjustments of the circuit. The spark gap, con-

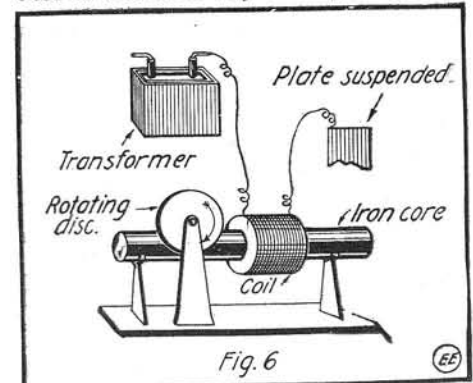

Fig. 6. Tesla's "One-Wire" Motor That Works on a High Frequency Current.

current passes through the magnet coil, magnetizing the iron core, and the rotating disc starts to move. Thus we have a single
(Continued on page 364.)

Stepping Stones for Junior Engineers

OUR young boys and young men who are mechanically and electrically inclined have to-day wonderful facilities opened up to them in order to

regards the initial cost of same, it is hard to conceive of anything more eminently practical and instructive. It is true that while most boys can gain considerable education

by reading the numerous books available on subjects in which they may be interested, it is also equally true that to gain a thorough and practical knowledge the actual work must be done in some form or other by the student himself.

These "stepping stones for junior engineers," as they may be called, are equally well adapted for training the mind of youthful embryo electrical, mechanical and civil engineers. At any rate, if the young student does not intend to follow up any of these professions, he will gain a practical knowledge of

four miniature steel masts may be constructed from these metal girders, and in this way a very good wireless aerial can be made up in replica, as perceived. Such an aerial as this would also be of good use for wireless demonstration sets utilizing the well-known coherer receptor, and particularly when these sets are used in lecture rooms and theaters where a small aerial 4 to 5 feet high or even less will suffice. The aerial may be made of copper wires No. 18 or No. 20 gauge, and a couple of insulators may be placed in the supporting towers as sketch shows. It is also possible to very easily build a miniature radio station building to be placed at the foot of the masts, as seen in sketch.

For the junior engineer there is probably nothing more interesting than the wonderful steam and electric shovels such as were used in excavating the Panama Canal, and as used throughout the country for railroad work in clearing away hills and embankments. Fig. 2 shows how one of these may be made up very nicely from these miniature steel beams. The shovel may be made to operate by an electric motor, and also a dry cell can be placed on the truck framework. If it is desired, a speed-controlling rheostat may also be mounted on the truck. To make this more complete it is well to place the whole machine on a length of track as shown in sketch. With a little skill and care this device will prove of unending interest to the boy mechanically inclined, and it will scoop up a heap of dirt in short order. The forward beam carrying the scoop proper is mounted so as to rotate, and thus each scoopful of dirt can be lifted and swung away from the truck before emptying, or it can be dumped into an empty freight car placed alongside of the shovel, thus following out railroad construction in some detail. Preferably an electric train should be used for hauling

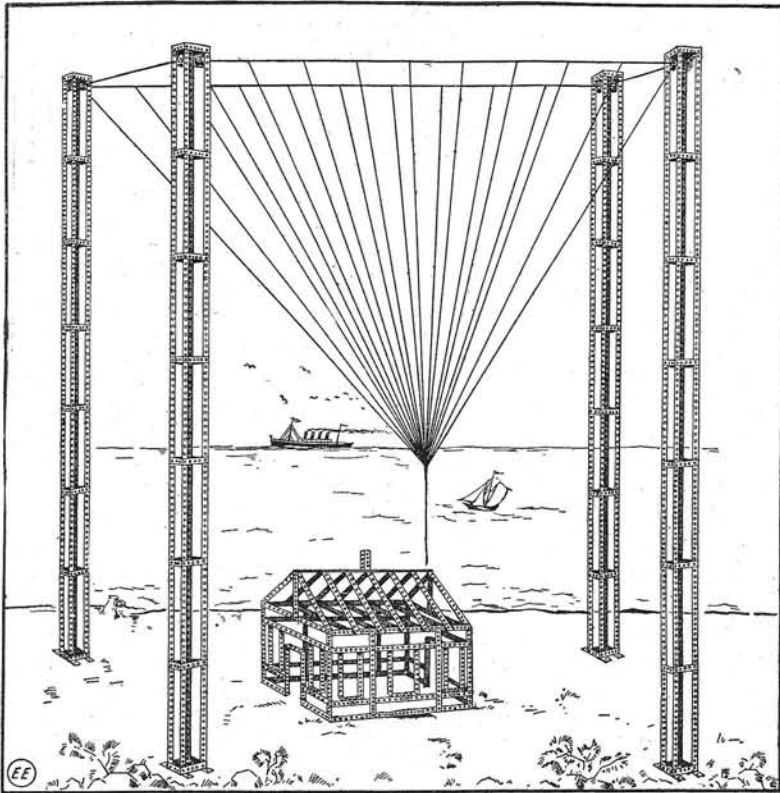

Fig. 1. Model Transatlantic Radio Station Constructed From Toy Girders.

train their minds on elementary engineering matters. There are, for instance, books on most every conceivable subject in the engineering and allied branches of science, electric toys and other apparatus which can be purchased cheaply, etc.; but there probably never has been a more distinctly practical and self-educating device brought out for the purpose aforementioned than that involving the use of miniature steel stampings made in the form of girders, beams and other necessary accessory parts.

The illustrations herewith will give some idea of what can be done by young boys, even 10 years of age, with these miniature steel beams and accessories. There are several large companies supplying excellent outfits of this type, with which it is possible to lay out and build sky-scrapers, wireless towers, railroad steam shovels, Ferris wheels, etc., in complete replica. While the present steel pieces making up these miniature construction outfits are quite light and also low in price as

how building framework, towers and other miscellaneous mechanical parts are to be fastened and laid out in order to insure

the greatest rigidity and strength, which knowledge all of us should have indeed. Our illustration at Fig. 1 shows how

the dirt away, and in this way quite an elaborate engineering project can be carried out very nicely by one or more boys.

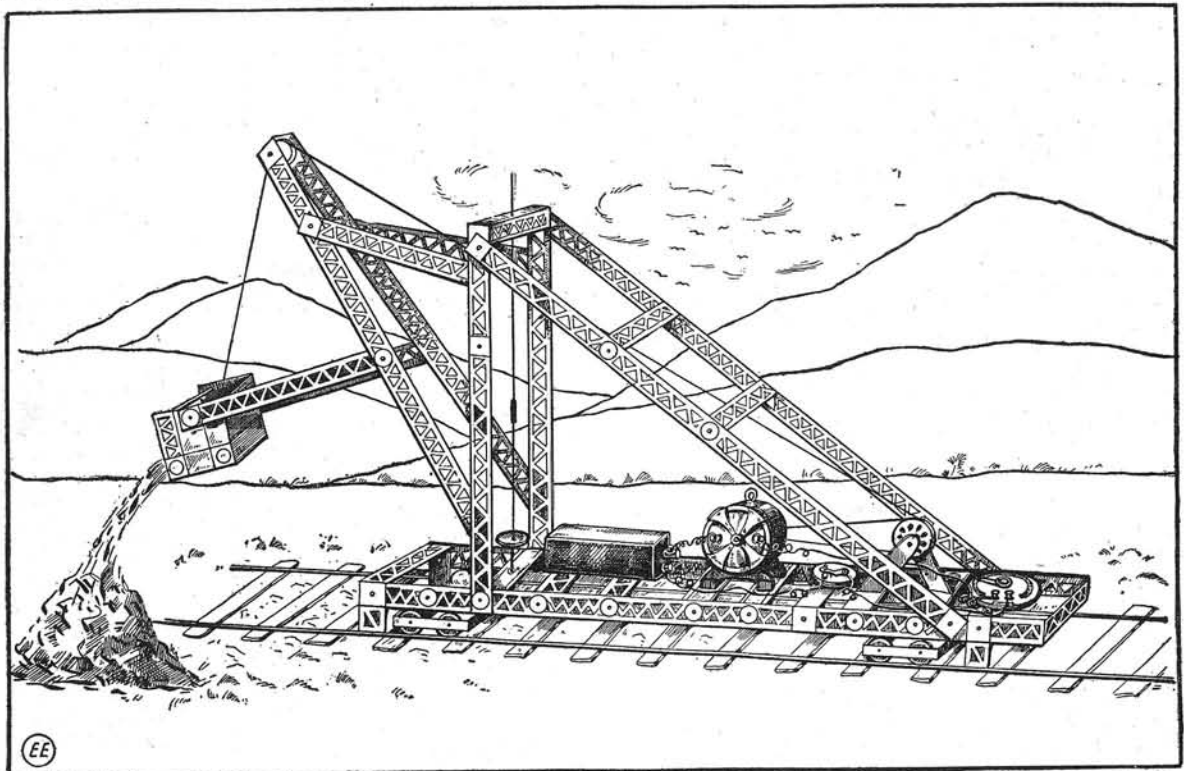

Fig. 2. A Realistic Steam-Shovel Composed of a Battery Motor, Some Miniature Girders, a Battery and Speed Controller.

At Fig. 3 is depicted details of construction for an elevator in a building, and this is moved up and down in a very natural manner by means of an electric

mass under pressure, moving electrons under tremendous pressure at the center of gravity must become luminous and throw off heat.

This theory would account for the sun as a luminous body, as a source of heat, as a powerful magnet, and also for the electrical disturbances seen near the sun during a period of sun spots; and if possible under these conditions for the sun proper to have a blackened crust on its surface, holes torn through these luminous electrons by gases would account for the sun spots and the fiery streamers that are hurled thousands of miles out into space. If we wish to carry this theory further, it is possible that these same little luminous electrons will account for the rings of Saturn, the Northern Lights and our Equatorial Light.

NEW FORMULA IN CALCULATING CURRENTS.

Probably the most accurate method of determining the value of the strength of an electrical current in absolute measure is by means of the Rayleigh current balance, in which the current to be measured is passed in series through two parallel circular coils of unequal radii, one of which is suspended from the beam of a balance. The distance between the planes of the coil is varied until the force of attraction between the two coils is a maximum, and the value of the force is obtained by adding weights to the other arm of the balance until its equilibrium is restored. Since the maximum force obtainable depends on the ratio of the radii of the coils alone, and not on their individual dimensions, it is only necessary to determine further the ratio of the radii of the coils, and this may be done with great accuracy by electrical means.

The constant of the instrument—that is, the maximum force per unit current for the coils in question—has been obtained in the past by interpolation between values of the force, calculated for various assumed distances of the coils, in the neighborhood of the critical value for which the force is a maximum. For although the general formulas of Maxwell and Nagaoka give the value of the force for any two given coils, at any assumed distance, with great accuracy, no formula has been heretofore published for calculating at what distance the force becomes a maximum. To supply this lack there is derived in a paper just published by the Bureau of Standards, entitled "The Calculation of the Maximum Force Between Two Parallel, Coaxial, Circular Coils," a formula which gives the critical distance as a function of the ratio of the radii. The latter part of the paper is devoted to the development of methods for facilitating the calculations. The formulas are illustrated by numerical examples and tables, and the new formulas are shown to give results in agreement with those derived by more indirect and laborious method of interpolation.

AUTOMATICALLY CONTROLLED ELECTRIC OVEN FOR TESTING SHRAPNEL.

Among the many varying applications of electricity constantly being brought before the public, and one of the most interesting at this time, in view of the conflict now raging among the leading nations of Europe, is an automatic thermostatic controlled electric oven.

This oven is for use in one of the Government arsenals in Pennsylvania for the testing of shrapnel shells. In the testing of these shells it is necessary that a temperature of 120 degrees Fahrenheit be maintained continuously for 24 hours. This control of temperature is obtained by means of a compact type of thermostat which makes and breaks the heating circuit. One contact point is carried by the expansion member of the device and the other is adjustable by means of a thumbscrew which extends outside the case. A condenser across the contact points holds the arcing down to practically nothing.

The oven is fitted with a mercurial thermometer for indicating the temperature. It is also fitted with a pilot lamp, connected in parallel with the heating element, to indicate when the current is on and off. On a continuous test for 24 hours the temperature of the oven did not vary more than one degree. This temperature reading is shown on the recording thermometer just above the oven in the accompanying illustration.

The oven is of especially rugged construction and is designed to withstand hard usage. The heating element is of the familiar type as used in electric ranges, and is rated at 200 watts.

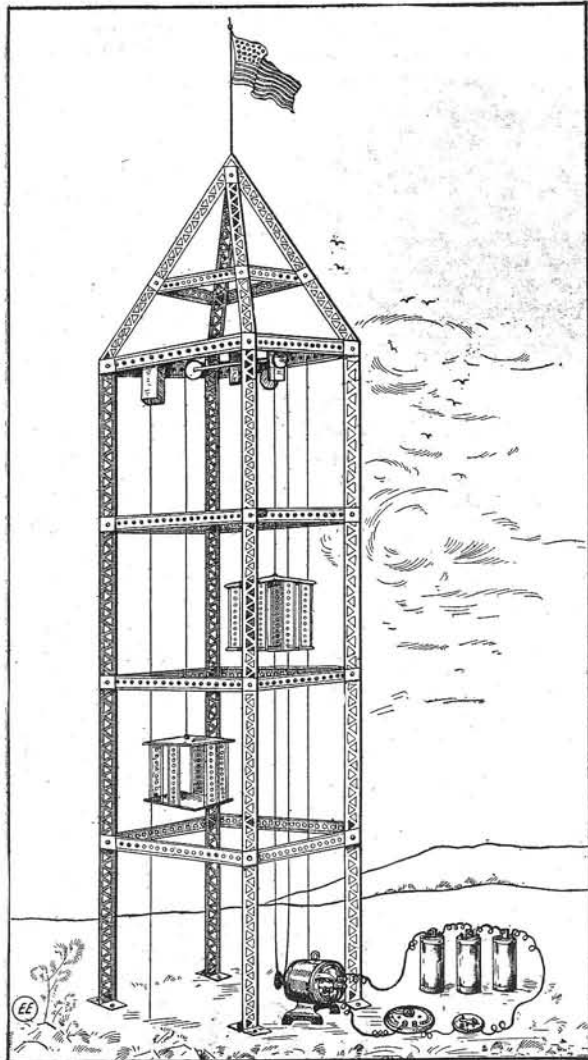

Fig. 3. Making a Sky-Scraper With Electric Elevator Out of Miniature Steel Beams.

motor, together with a rheostat, switch and battery, as observed. There is practically no limit to the number of different designs such as these which can be worked out in an excellent manner by making use of a small steam engine or electric motor and a quantity of these miniature steel beams and the variety of odd parts, such as gears, pulleys, etc., supplied with them.

HOW SUN SPOTS MAY BE CAUSED.

BY PROFESSOR G. W. COOPER.

As we gradually descend into a mine, toward the center of the earth, the temperature rises so rapidly that many scientists believe that the center of the earth is a molten mass, caused by pressure or gravitation. When we realize that the sun, 93,000,000 miles away, attracts the earth with sufficient force to hurl millions of tons of water on our coast line, and that gravitation decreases as the square of the distance increases we can partially realize the tremendous attraction at the center of gravity of the sun. The center of gravity, like the magnetic poles of the earth, is not stationary but is continually shifting. If electric fluid is composed of electrons, and is universal, the electrons at the center of gravity must be under a heavy pressure, and if the center of the earth becomes a molten

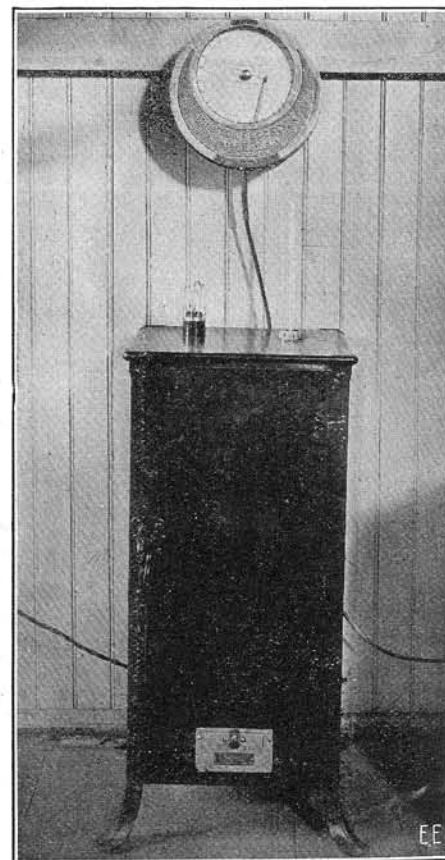

Electric Oven With Automatic Heat Control for Shrapnel Testing by U. S. Government.

Electric ovens have been found to be superior to any other method on account of the perfect heat distribution. They can be used for a number of purposes, such as enameling, baking cores, drying, etc.

ILLUMINATED STEAM CURTAIN GIVES WONDERFUL EFFECT AT NIGHT.

The illustration herewith shown portrays the remarkable effect produced at night by a brightly illuminated steam curtain, as erected under the supervision of a corps of Harvard University students, the work having been in charge of Theodore C. Brown, of Harvard.

This installation was employed in a wonderful outdoor show entitled "The Pageant of Lexington." This steam curtain served the same purpose as a regular theater curtain when the different scenes and tableaux were being assembled. The entire entertainment was planned on such a large scale that the only way the curtain effect could be produced, it seemed, was by the employment of a steam curtain as the photograph herewith illustrates in a vivid manner.

The illumination for the Lexington pageant was planned by the engineers of the Edison Lamp Works of the General Electric Co., at Harrison, N. J., and it, in its entirety, involved the use of dozens of very powerful searchlights, besides a large number of powerful tungsten lamp banks and other sources of electric illumination unknown in their magnitude to the regular theater stage.

ELECTRICITY AND THE 20TH CENTURY DENTIST.

Electrical apparatus is being utilized more and more every day to aid our surgeons and particularly dental surgeons. In the photograph herewith is depicted an up-

dentist to hold the drill at any angle desired. Special forms of miniature "searchlights" help the operator to examine any remote part of the mouth and to work with ease and surety.

EXPLOITATION OF FINLAND'S WATERFALLS.

The Petrograd Joint Stock Company for Transmission of Water Power has made application to the Governor of Vyborg for permission to exploit the water power from the waterfalls of Rouhialasky. It is proposed to build a dam reaching from one bank to the other, with five passages of 46 feet in width for the water currents, of a depth of 58 feet. According to the calculations of the Finland Hydrographic Bureau, the flow of water is 42,000 cubic feet per second, and can be directed through four passages. The project

be operated at a power cost that is practically negligible, ranging from two cents to five cents an hour and depending upon the size of hammer used. The equipment investment is small, only the first cost of the tool having to be considered.

To use one of these hammers it is only necessary to connect the tool to the nearest lighting outlet or wires.

The low first cost of the equipment, combined with the ease of operation, makes its use advantageous and practicable, not only where pneumatic tools have heretofore been used, but on a large class of work whose magnitude did not make it economical to install an air outfit.

A man with an electric hammer may be expected to do about as much work as six men working by hand. This is easily explained by the fact that a man with a hammer strikes from 50 to 80 blows a minute, while the electric tools strike from

1,400 to 4,000.

These electric hammers have long since passed the experimental stage and are being used successfully by companies installing switchboards, pneumatic tube systems, piping, railings, sprinkler systems, fire escapes, fire doors, etc. One large contractor tells of the great saving through the use of these tools in taking out the mortar between bricks for repointing, another of using them in breaking up old engine-bed foundations and sidewalks. Paint mills use them for dressing mill stones, ice plants and central stations for chipping scale off condenser tubes. In fact, wherever a rapid

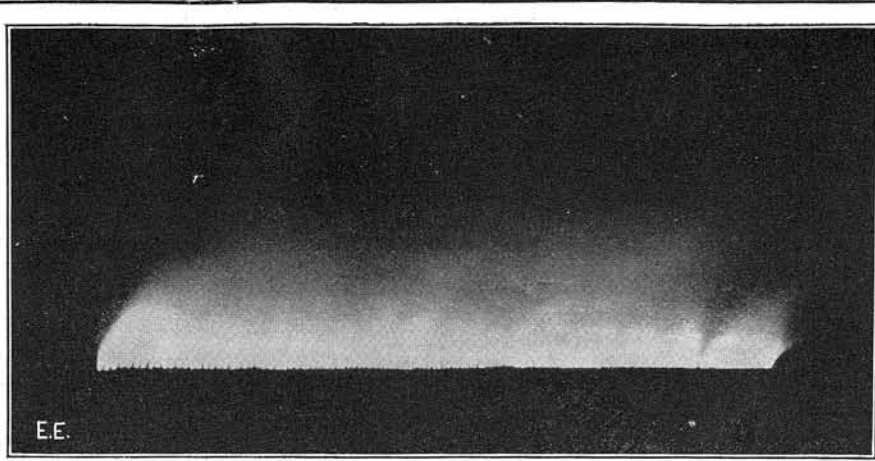

Mighty "Steam" Curtain Illuminated at Night. It Served for a Regular Theater Curtain.

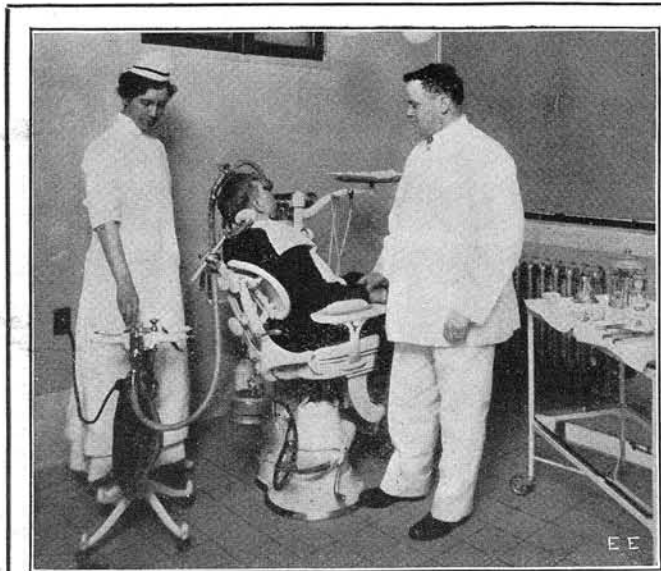

Electricity Aids the 20th Century Dentist.

to-date electrically equipped dental operating room in a well-known hospital located in Boston, Mass. All articles in this operating room are furnished in the most sanitary way even to the chairs which are finished in porcelain and enamel.

Electrical foot control rheostats are conveniently placed about the chair in which

EFFICIENT ELECTRIC HAMMER.

One of the special applications of electricity comes in the use of electric hammers, replacing the man with the sledge or hammer and star drill and the air compressor with its piping and hose.

The line of hammers that is made by one of the leading electrical manufacturers can



Improved Electric Hammer.

provides for the erection of nine aggregates of turbines of 10,000 horsepower each. Water power is the most efficient available.



Old Manual Sledge Method.

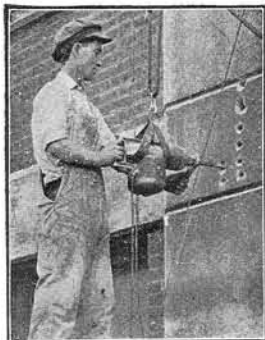

New Electric Hammer Method.

succession of blows makes for saving, these electric hammers are being used successfully. They operate on the reciprocating electromagnetic system and provide a much-desired implement for this class of work-

THE CONSTRUCTOR



How to Build a Dictaphone Desk Set

By Homer Vanderbilt

THE desk telephone outlined below is a first-class instrument, very novel and new, besides being of easy and simple construction. Furthermore, the use of this instrument is different from the ordinary telephone, in that the receiver and transmitter are not brought into contact with the party using them. One may communicate with another party by merely placing the apparatus at a suitable distance on the desk and talk in the usual way without holding the receiver to the ear.

The case may be constructed, as shown in Fig. 1, from some hard wood, such as oak, walnut or mahogany; the base of which is hollowed out, so that the ringing key and contacts may be placed inside. It should then be glued or screwed together, using flat head brass screws for the purpose, which will make a very neat job. The front wooden piece is made as depicted in Fig. 3, and into the two holes are placed the transmitter and receiver. The transmitter is of the "Dictaphone" type, as illustrated at Fig. 4. The case is built from an old watch case receiver, with the usual parts removed.

The cap is placed in a lathe and the hole made larger with a boring tool, until it measures $1\frac{1}{4}$ inches in diameter. This increases the area of the diaphragm; thereby also increasing the sensitivity of the transmitter. The carbon cup, C, is made up from a circular carbon rod $1\frac{1}{8}$ inches in diameter and $\frac{3}{4}$ inch long. Five holes are drilled with a No. 14 drill on one face of the carbon, as Fig. 5 shows. These holes must be *exactly* drilled. The two faces of the carbon rod, C, must be exactly parallel with each other, as the operation of the transmitter is entirely based upon this point. In order to do this it is advisable

and if O. K. fill the holes in the cup with small carbon balls (not grains) about the size of the head of a pin, procurable from electrical supply houses. The diaphragm is now replaced and securely fastened and

button. This rings the party at the other end of the line; and with both parties situated at about 6 feet from the telephones, conversation can be easily, distinctly and audibly conducted.

This new method eliminates the tiresome holding of the receiver and, above all, holding of the mouth near the unsanitary and (sometimes) germ-carrying transmitter.

As the current used is quite heavy, a large wire must be used to connect the two stations together. For stations 20 feet apart No. 18 B. & S. wire will do. For a distance of 50 feet use No. 16 wire; for a distance of 100 feet use No. 14 wire; for a distance of 200 feet use No. 12 wire.

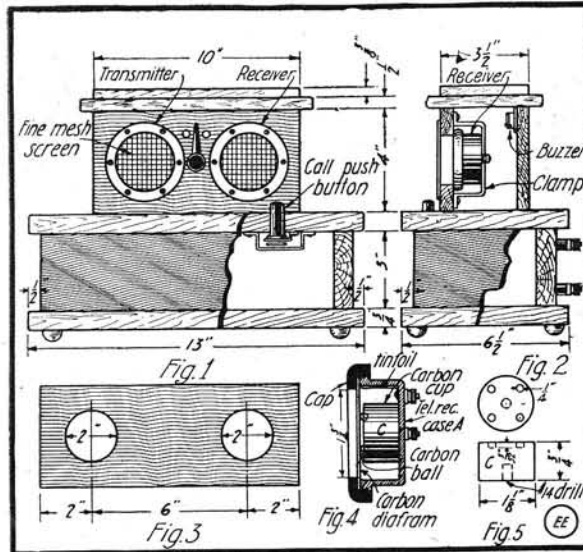

Details of Dictaphone Desk Set.

the tin-foil is connected to a binding post, as depicted in Fig. 4. The transmitter is now tested by connecting a telephone receiver in series with a battery.

After completion and test of the transmitter it should be placed back of one of the holes in the front wood piece and securely fastened by means of a brass strip, as Fig. 2 illustrates. The hole is then covered neatly with some coarse mesh screen.

The receiver is of the watch case pattern and also of the low resistance type. A 75-ohm receiver is obtained and the permanent and electro-magnet removed. The coil is rewound with 120 feet of No. 26 enameled wire and then replaced in the case without the permanent magnet. The connections of the coil are made in the same manner as the previous winding. After this has been done it is placed behind the second hole in the cabinet front and fastened in the same way as the transmitter. A screen is put over it, as illustrated in Fig. 1.

The ringing key, or "double contact" push button, which is located in the lower box, can be made in any form and no further description is necessary. A buzzer for calling is placed on the inside back of the case, as indicated in Fig. 2, and also a 2-point switch for the circuit is mounted on the front, as seen.

Fig. 6 outlines the connections for two sets of apparatus. Several of these outfits can be successfully used in circuit if desired. Three to four dry cells are usually sufficient for each station on 50 to 75 foot circuits.

Now, with the above apparatus completed, close the switch and press the push

A "KID CHASER" FOR WAGON TAIL-BOARDS.

For truck drivers and others who are often annoyed by children stealing rides on tail-boards, the following scheme will be found efficacious in the prevention of this dangerous nuisance.

All that is required is a small spark coil giving $\frac{1}{2}$ -inch or greater spark, together with batteries and controlling switch, which may be mounted on the back of (or under) the seat of the wagon. Two high-tension wires are carried along the frame of the wagon, as 1 and 2 indicate in sketch. One wire is joined to the hinge of the tail-board or simply direct to a metal strip 4. A second metal strip is placed across same at 3, and

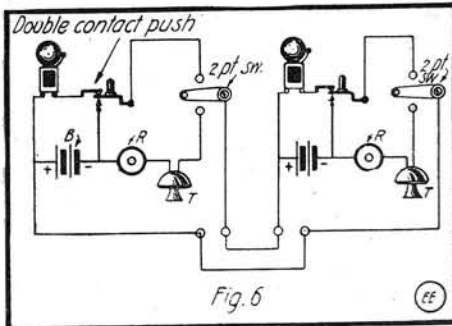
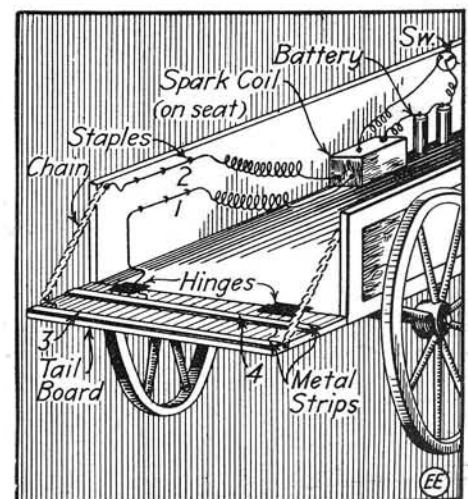

Fig. 6. Connections of Dictaphone Set.

to have it turned in a lathe. The bottom hole for fastening it is now drilled with a No. 14 drill, and then some melted sealing wax is poured into it. While still soft an 8-32 brass screw is inserted and the wax is then allowed to cool. This finished, it is placed in the receiver case and a carbon diaphragm placed over it, with a sheet of tin-foil pressing on the diaphragm in order to make contact. Test the circuit to see that the cup does not touch the diaphragm



Spark Coil to Keep Children Off Wagon Tail-Boards.

this is joined to the high-tension cable through the supporting chain, as sketch indicates.

Now, when the youthful joy rider mounts the tail-board the driver can throw in the switch and the pleasure trip is abruptly terminated. Contributed by T. W. B.

Construction of an Inductive Tuner

By Milton B. Sleeper

Part II—(Conclusion)

Coupling Adjustment.

The back and side views of this unique control are shown in Fig. 10. On the same shaft with the handle is fastened a square brass tube. Inside this is a square rod. To prevent its interfering with the secondary taps it is bent out. The upper end, which is flat, has a round tube going through it parallel to the shaft of the handle. When the instrument is assembled a rod held

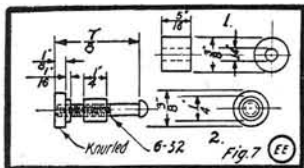

Fig. 7. Details of Binding Posts.

tightly by the screw eyes on the end of the secondary turns in the tube (see Fig. 3). As the handle is turned the square rod slides in or out of the tube, because the rod at the top must travel in a straight line, while the guides inside the primary keep the secondary from turning. Oil all the moving parts; there is no current carried in this adjustment.

Binding Posts.

Referring to Fig. 7, these binding posts are composed of four parts: a screw, a hard rubber bushing, a nut and a thumbnut. The bushings must fit tightly in the

Coil Center Pieces.

Fig. 8 gives the size of these pieces. In turning them up, bore the 1/2-inch hole in the center first; then turn them on a wooden face plate which has a little mandrel to fit tightly in the hole. If the hole is not exactly in the center of the pieces the secondary will not be concentric with the primary. Take (A) first. After shellacking and rubbing it down fasten it in the left-hand end of the primary tube with strong glue. To fit properly in the box the end of the tube must be at right angles with its axis.

Before fitting (B) each secondary tap must be fitted with soft rubber tubing to insulate and protect it from rubbing. When this is done pull all the taps out at the left-hand end of the coil and bind them together with string 1/4 inch from the coil. Leave two or three inches of the binding string on the taps. In (B), between the slit and the center, make a small hole, just large enough to pull the loose ends of the binding string through it. Now bend the taps where they are bound and pull the ends out of the right end of the tube.

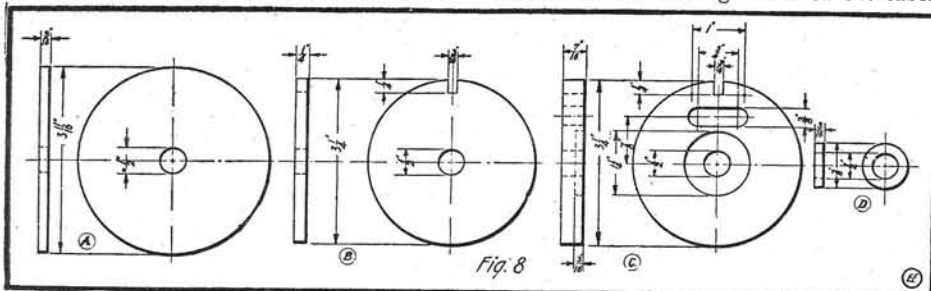

Fig. 8. End Discs of Secondary Coil.

holes in the case; a little shellac will make them stick. The connections on the inside should be neatly soldered to the under side of the screw head. Then the nut is screwed tightly on the bushing. Outside

When (B) is glued in place fasten the binding cord through the little hole, so that the taps will be held firmly to the wooden end. This is to prevent their breaking off from bending back and forth as the secondary is moved. The taps should come at the top of the coil. At the bottom of (B) fasten a little brass piece X that will slide between the guides inside the primary. Put in the piece (C). Divide the taps into three or four bundles to go through the hole in the end piece. That is all there is to do with the coils at present.

Cabinet Front.

Fig. 9 gives the dimensions for the front. Great care must be used in laying out the holes for switch points. Always make a dent with a center punch first, otherwise the drill point will run over the rubber. They should be laid out with a pair of sharp-pointed dividers. First make a circle 1.34 inches in diameter. Then, by experimenting, the exact distance can be found to separate the holes. If the cir-

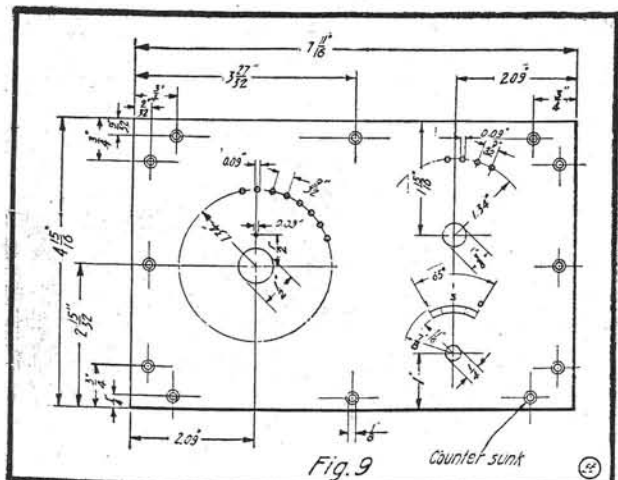

Fig. 9. Switch Lay-Out for Inductive Coupler.

connections are clamped by the knurled thumbscrews. This makes a neat and leak-proof binding post.

cle 1.34 inches in diameter. Then, by experimenting, the exact distance can be found to separate the holes. If the cir-

cle is just 1.34 inches in radius 9/32 inch will go in the circle just 30 times. The holes for wood screws are countersunk just enough to make the screw heads flush.

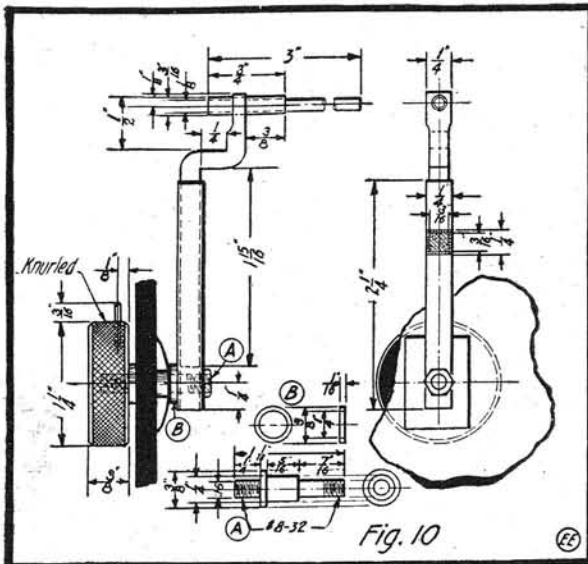

Fig. 10. Arrangement of Secondary Coupling Lever and Knob.

In laying out the scale for the coupling handle, score the hard rubber with the dividers. Then with a very fine brush fill in the scratches with white paint. This makes the scale stand out clearly.

Connecting the Taps.

When the switches are all fastened to the front it is time to connect the taps. By all means use lugs for this. The right size can be obtained from Clapp-Eastham. As each one must be soldered to the wire, it is advisable to get some very soft solder which can be melted by the heat of a match. There are several kinds on the market. Start at the left of the coil with the compensator taps, otherwise you will get into trouble. Cut off the taps a little longer than is necessary to reach from the coil to the switch. Do not take any chances on finding, when you put the coils in the case, that the taps are too short. Slip a piece of rubber tubing 3/8 of an inch shorter than the tap over the wires. Then solder on the lugs. It is best to try this on a separate piece of wire, for some difficulties may be encountered. When the compensator connections are made (see (2) Fig. 4) do the same to the other taps.

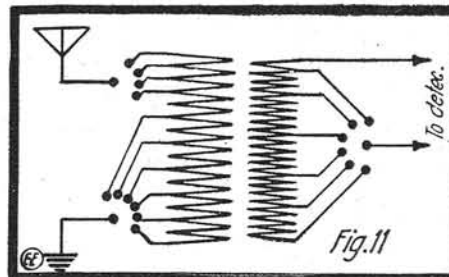

Fig. 11. Hook-Up for Coupler.

Starting with the tap from the seventh turn, fasten it to the top switch point on the large circle. Go around in order until the last one is connected to the thirteenth point. Test the coil with a buzzer and battery to see that the winding is all right. Do not touch the secondary taps until the coils are fastened in the case.

HOW TO BUILD AN ELECTRIC SPEEDOMETER.

A most interesting application of electricity is represented in an electric speedometer, an instrument used for denoting the speed of vehicles or any other moving object.

This type of speedometer consists essentially of two parts, viz., a direct-current generator of low amperage, which is driven



Fig. 3

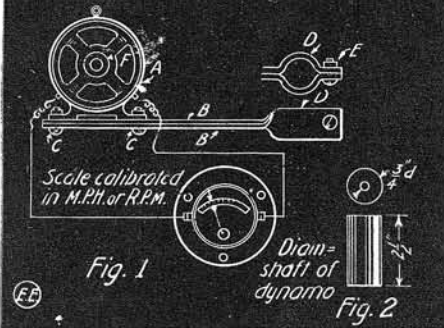

Fig. 1

Fig. 2

Electric Speedometer for Bicycles.

by friction or gearing from the wheel of a vehicle, for instance, and a voltmeter connected directly to the generator.

The dynamo, Fig. 1, may be an 8 or 10 volt machine. Now make the supporting parts, which consist of two iron clamps B B, attachable to the dynamo frame by means of bolts C C. The curved part D is used to fasten the dynamo to the vehicle, such as a bicycle frame, tightened by another stove bolt E. Any other suitable means can be employed in fastening the dynamo.

A small rubber friction wheel is next made, and it is shown in Fig. 2, no explanation being necessary, as all the required data is given. It is driven tightly on the dynamo shaft and is to be placed in contact with the driver wheel.

The recording device consists of an ordinary voltmeter, but another scale is substituted for the original one and calibrated in speed units, such as "miles per hour" or R.P.M., etc. The method of calibrating the voltmeter is as follows: Obtain a standard speedometer and place on the driver wheel, and at the same time secure the dynamo near the same driver and connect it to the voltmeter. Now start the vehicle wheel running (on a frame) and observe the scale on the standard speedometer, and note the position of the voltmeter needle. At that point mark a line, and the same figure as the standard speedometer is showing. Various points should be thus checked off in the same manner by running the vehicle wheel slower or faster.

This device can be used as a tachometer or revolution per minute indicator, the one point that must be remembered being to use a standard R.P.M. indicator as a means of calibrating.

The voltmeter should be placed in a convenient place, so that the operator may cast his eyes on it very quickly. On a bicycle a good place is on the handle bars, as shown in Fig. 3.

This speedometer can also be used on automobiles, carriages, motorcycles and any other form of vehicle. It is useful indeed for testing machinery of all kinds. The calibration can be performed by calculation, aided by a common hand speed indicator. A small telephone magneto serves very well for this stunt, but then the voltmeter must be an A. C. instrument. Contributed by **SIDNEY SISSELMAN.**

AN ELECTRIC KEY HOLE FINDER.

For those gentlemen who are inclined to stay out too late in the evening, or rather morning, and who often experience considerable trouble in locating the keyhole in the front door of their domicile, the following wrinkle may be of interest:

I notched out a small hole in the side of the door frame on my front door and placed in it a miniature battery lamp receptacle and a small Tungsten flashlight bulb. A battery may be placed in the cellar similar to a bell battery, etc., and ordinary bell wires, preferably fished up inside of the door frame, or otherwise neatly concealed, lead from the lamp socket to a circuit closer placed under the front door mat as the sketch shows. This circuit closer may be purchased at any electrical supply store and can be located under a certain corner of the mat, etc., so that the home-comer will possibly sooner or later place his foot on the proper part of the mat, and thus flash on the lamp which illuminates the key-hole.

It is hoped that this novel idea will be found welcome to many brother "Elks." Some nifty stunt. Eh! what?

Contributed by

ALBERT GALLAGHER.

It is generally admitted that the hardest problem is to find the keyhole in the "wee small hours" of the morning. The writer of this article presumes, evidently, that the rapidly oscillating movement of the feet



An Electric Light Finds the Key-Hole For You.

very shortly will locate the proper contact spot on the mat.—Ed.

CHARACTERISTIC FLAME COLORS OF METALS.

When a gas containing metallic ions is heated to incandescence it exhibits a color and a spectrum which are characteristic of the metal which it contains. Each of the 60 or 70 known metals has its own flame color and spectrum. With the alkali and

alkaline-earth metals, it is only necessary to heat a salt of the metal in order to obtain the colored flame. With all the others, however, the metal itself must be volatilized, which can readily be performed by the electric arc or spark.

The exhibition of these various flame colors is an interesting and rather spectacular experiment. For the metals of the first division the apparatus is very simple. An alcohol lamp, which can be easily made out of a small bottle, a cork, a metal tube and a wick, is provided for each metal and labeled. In the alcohol of this lamp a salt

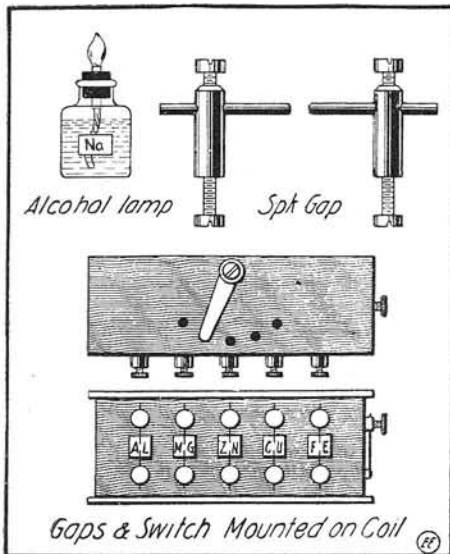

Apparatus for Testing Flame Colors of Different Metals.

of the desired metal is dissolved. The chloride is the most convenient, both because it is the commonest salt and also because it is soluble in alcohol. The salt must be chemically pure, for if it is not it is sure to contain traces of sodium, whose brilliant yellow flame quite obscures that of any other metal.

The presence of traces of sodium in atmospheric dust and moisture may be proved by holding almost any object (an iron nail for instance) in the colorless Bunsen flame, which will be turned yellow for a moment. If the salt dissolved in the alcohol is chemically pure, however, the flame of the alcohol lamp, instead of being colorless, will be yellow, violet, green, orange or deep crimson, according to the metal used. In a darkened room this is very striking. The colored flame, when examined with a spectroscope, shows the characteristic lines of the metal.

For showing the metals of the second class a series of small spark gaps are used; the electrodes of the different gaps being made of the metals to be examined. The gaps are put into operation, one at a time, by means of a suitable H. T. multi-point switch. The electrodes should be very close together, almost touching, so that the "spark-ball" may be formed. A very brilliant flame is produced in this way. It may be examined with a spectroscope, the same as the alcohol flame.

Below is a list of the more common metals and their flame colors:

FIRST GROUP.

Sodium, Na	Yellow
Potassium, K	Violet
Calcium, Ca	Orange
Barium, Ba	Green
Strontium, Sr	Crimson

SECOND GROUP.

Magnesium, Mg	Dazzling white
Aluminum, Al
Zinc, Zn	Blue
Copper, Cu	Green
Iron, Fe	Reddish yellow

Contributed by **B. MACKEY.**

RADIO DEPARTMENT



The Amateur Radio Station Which Aided Uncle Sam A Complete Description of the Wireless Station of Mr. Charles E. Apgar—Full Details of the Audion Amplifier Circuit and the Inductance Coils Are Here Given

By Charles E. Apgar

SINCE the publication of the article on recording Sayville radio signals phonographically in the September, 1915, issue of the *Electrical Experimenter*, so many inquiries have been received by

me a copy of the latest catalogue of one of the leading experimental wireless supply houses. Careful study of this and recalling the zig-zag lines and drawings in the magazine (*Modern Electrics*), to which

recourse was made, gave me sufficient insight as to the requirements of amateur wireless telegraphy to make a "try-out" about one month later (Dec. 11, 1910). I shall never forget with what satisfaction I made my final connection on that memorable evening. In less than one minute I heard O. H. X (now W. H. B.) Scagate and one other station. Contrasting this with the experience of some amateurs (who, as I have read, often spend a month or more fooling around before getting a single signal), to say I was satisfied is putting it mildly. Of course, the whole family was called in—even the cat—whose "meow" was about as near to a wireless signal as anything I had ever heard.

later a rotary, capable of breaking 960 per second. Getting rather tired of hearing "How's my spark?" "Do I sound better now?" I decided to turn my attention to improving my receiving apparatus. In all seven different tuning coils and loose couplers, each possessing some special feature, have been made (see *Modern Electrics*, January, 1914). Variable rotary condensers were next constructed and, being dissatisfied with the unstableness of crystal detectors, I decided to try out an audion during August, 1913. Having some knowledge of the effects of magnetism on electricity in a vacuum, I placed a magnet near the audion, when instantly the signals seemed about ten times louder. Here was a discovery—to me at least. A new 150-foot steel mast loomed up, as well as other extravagant expenditures—all to come from the proceeds of this discovery—but a short time spent in the city library brought me to earth again. I still have my aerial in the trees.

The use of the magnet was continued for some months with gratifying results. Many stations, with the use of a small horn on the receiver, could be read about 50 feet from the 'phones. Having been able so definitely and satisfactorily to produce loud incoming signals, the matter of amplification occurred to me. I tried out various types of microphone transmitters. Best results, though far from satisfactory, were obtained by a certain form of carbon transmitter, using a low voltage current. Signals from many stations, when using this circuit after some modifications and



Fig. 1. Top View Depicts Mr. Chas. E. Apgar Receiving Wireless Messages at His Wonderfully Efficient Experimental Radio Station Located at Westfield, N. J.



Lower Photo Shows Mr. Apgar in the Act of Actually Recording a Long Distance Radio Message on a Phonograph Cylinder. This "Canned Wireless" Has Helped Uncle Sam Immeasurably.

me from interested amateurs and others concerning many details of construction, circuits, etc., that I thought that possibly a more complete statement concerning the station and the work accomplished would be welcomed by many readers. Also since the station has been so generously referred to in the daily and technical press since July 18, 1915, a brief history of the station itself will surely be of interest.

Not many years ago, less than five, when looking over a magazine in a stationery store on Broadway, New York, I noted in the back section some zig-zag lines and drawings (diagrams of radio circuits). The magazine was immediately laid aside with the thought: "What nonsense to print such crazy stuff which only an expert can understand."

About a month later the New York Herald published a letter signed "Amateur" stating that on the previous evening (Election night, November, 1910), he had copied the Herald's wireless Election returns and knew the results of same before 11 p. m. of that evening. Comments by the editor followed, stating that "Amateur" was a cashier in one of Wall Street's well-known banking houses; the name and address were also given. This was my first stopping place when again reaching the city.

This cashier soon discovered that I didn't know a tuning coil from a detector, so he

Having caught the fever and having some constructional ability, my instruments were home-made, excepting the detector stand and silicon (purchased from the E. I. Co.) and 'phones. After installing this set on a suitable operating table and getting reasonably familiar with tuning operations, even to picking up Cape Cod (old M. C. C., distant about 250 miles), I decided to look into the matter of sending signals. I found a single unit automobile spark coil among some electrical junk, connected this to my aerial through some wire wound around a box and having no sending key, tapped on one of the binding posts with one of the battery wires to see if it would buzz. It did. Then without knowing why, I tapped off the call "B. Q.," whom I had heard sending to other amateurs. "B. Q." lived many blocks away, but after a reasonable time the door bell rang and, much to my surprise, there was B. Q. in person. Said he had heard me call him, and though it was near midnight, came around to see what I wanted. This experience led me to believe that an efficient sending set would not be difficult to make. I soon began constructing a 1/2 K. W. open-core transformer, also a suitable condenser, using aluminum sheets and old photographic plates; an ordinary spark gap at first, but

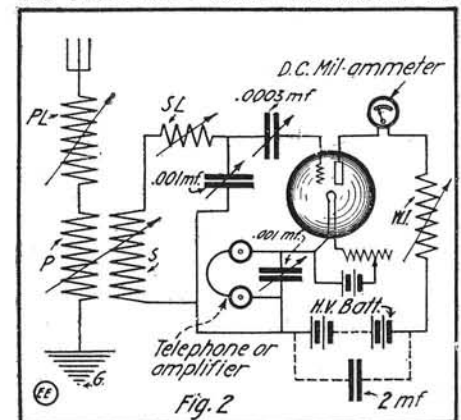

Fig. 2. Audion Amplifier Circuits Employed in Mr. Apgar's Radio Station.

giving careful consideration to sound resonance, could be plainly heard and read all over the house.

Naturally the matter of making permanent records occurred to me about this time. I bought a second-hand phonograph, and on Oct. 28, 1913, made my first record

of wireless; this being "press," sent out by the New York Herald station at the Battery in New York. Following this and until about October, 1914, many records were made of N. A. A., N. A. H., W. C. G. and other stations. By the adoption of the audion circuit discovered by Mr. E. H. Armstrong, the receiving efficiency of my outfit was enormously increased, as well as being enabled to bring in many undamped wave stations, including W. S. L., W. G. G., N. A. A., N. B. A. and others. Interesting phonograph records of several of these undamped stations have been made.

The photograph of my station is shown in Fig. 1, which consists virtually of a loose coupler, primary and secondary loading coils and three variable condensers connected to an Armstrong circuit as perceived in Fig. 2. The dimensions of my inductance coils are as follows: Primary of coupler is 10x5 inches and is wound with No. 22 S. S.; the secondary is 10x4 1/4 inches, wound with No. 28 S. S.; the secondary loading coil SL is 22x3 1/2 inches and wound with No. 30 S. S., while the wing inductance WI has No. 30 S. S. for its winding. The capacity of each condenser is given in the diagram.

A direct current milli-ampere meter is connected in series with the grid circuit as shown and signals* can actually be read by observing the movement of the needle. An amplifier of my own invention is connected in place of the regular 'phones and a low resistance receiver with horn is coupled to the amplifier. The same 'phone can be placed over the recorder of a phonograph and thereby messages may be copied on a record. Fig. 3 illustrates the phonograph which has recorded all the Sayville "secret code" messages—note the telephone receiver on the reproducer.

My aerial is 600 feet long, the wires starting 10 feet apart and ending 18 inches apart (fan shaped); the average height is about 50 feet. With this set I am able to tune to 4,000 meters without any aerial inductance coils, and if loading coils are connected in the circuit I am able to receive stations of over 9,000 meters wave length.

While the September, 1915, issue of this magazine has given rather a full account of the work done at the request of Chief W. J. Flynn, of the U. S. Government Secret Service Bureau, probably the addition of a few other details will make the account more complete.

A short time before being asked to do this work a business call was made on Chief Radio Inspector W. P. Krumm at New York City, and during a conversation on amateur plants in general he expressed a desire to visit my station. During this visit, which soon followed, the general efficiency of the station was demonstrated, also many phonographic records of wireless signals were reproduced. Hence when Chief Flynn consulted W. P. Krumm about the *checking up of Sayville* I was called in on the matter and told to "get busy." The work of making the records began each night at 11 o'clock and continued for two or three hours, dependent on the accumulation of messages at the Sayville station. The next morning a translation of the records was made and a copy of them turned over to Chief Flynn, which permitted of immediate comparison with the censored message records received by other departments of the Government. Later on all the phonograph records made were delivered to the Secret Service Bureau at New York City.

*One of our editorial staff has recently witnessed this experiment with the milliamperemeter. Signals were readable by merely observing the

New Pocket Wireless Set

One of the latest developments in the wireless field is a small, pocket-size wireless instrument which can be used for transmitting or receiving such messages over distances of one-quarter to one-half mile and more. This particular apparatus

metal tube held in the hand to the instrument proper. In some cases the tube has been placed in the ground and messages received and transmitted in this way. When the metal tube is held in the hand, as shown in the right-hand photograph, it



Photo (C) by Underwood & Underwood.

At Left: Showing New Pocket Wireless Set Fastened to Belt. At Right: Dr. Cox Receiving Radio Signals With Pocket Set.

as shown in our illustrations has been perfected by Dr. H. Barringer Cox, of New Bedford, N. Y. The inventor himself is seen in our illustrations, the one at the right depicting Dr. Cox in the act of receiving a wireless message by means of the apparatus strapped about his waist as perceived, and the antenna consists of a hollow tube held in the hand.

The left-hand view discloses how the apparatus may be worn under the coat, and it is held in place by a belt, as becomes evident. The 'phone and head-band can be hooked in the belt very readily, and it is suggested by Dr. Cox that this outfit would undoubtedly prove of great value for the soldiers in the field. He intends to loan his invention to the European armies now at war. Such an outfit as this can be worked over such distances as aforementioned and should prove of extreme value to the men in the trenches or on the open field for transmitting and receiving orders, etc., as the enemy would not very easily take notice of such a well-concealed wireless instrument as this, even though the operator was in sight. The apparatus comprises an especially sensitive detector, together with the usual high resistance head 'phone and a tuning coil with condenser. A flexible wire joins the watch-case telephone receiver to the tuning coil case, and another flexible conductor joins the hollow

needle. One of the greatest feats ever produced by any amateur is receiving N. A. A. 600 feet from the 'phones, which is an actual result accomplished by Mr. Apgar. He has received the "time signals" from Arlington in the open street, full of shade trees and while noises of all kinds were in the vicinity. Of course, if these conditions did not prevail the signals would undoubtedly be heard at a much greater distance.—EDITOR.

would undoubtedly be best to make a ground connection by means of a wire connected up with a metal plate on the bottom of the shoe.

MARCONI ABSORBS ENGLISH POULSEN INTERESTS.

A syndicate representing Marconi interests has acquired the Poulsen-Padna rights, and in due course the Poulsen system will become part of the Marconi organization.

According to this report, an important option in connection with the British Poulsen wireless rights lapsed recently, though fresh arrangements would quite possibly have been made. In the meanwhile, however, the syndicate representing the Marconi interests, recognizing no doubt that a formidable rival the Poulsen system would be in the future if it remained independent, has stepped in and made an offer which apparently has been accepted.

For the present, owing to Treasury restrictions, formation of a subsidiary company and other financial arrangements for the completion of the deal cannot be put through, but after the conclusion of peace it may be looked upon as certain that Poulsen will be under the Marconi banner.

The Poulsen system of wireless telegraphy, worked out by Valdemar Poulsen, of Copenhagen, eight years ago, is said to be a much faster means of communication than that of Marconi. In 1907 Professor Poulsen also talked by wireless between Copenhagen and Berlin, some 250 miles, and proposed to establish a wireless telephone service to America, via Ireland. The Poulsen patents in the United States are controlled by the Federal Telegraph Co., of San Francisco, Cal.

A MACHINE THAT CAPTURES AND HOLDS WIRELESS TALK.

When one contemplates the marvel of sculptured sound on a graphophonic record, and realizes that from the cold vorticity of line there may magically spring the golden lilt of the greatest song voice that the world has ever heard, then comes the conviction that we are living in the days of white magic.

This is simply by way of introduction of a greater marvel yet—a marvel of marvels, so to speak, regarding the reproduction of sound. It is the application of the Poulsen

of this necessity, and has conceived the ingenious idea of powdering the steel disc with a finely divided magnetic substance—iron reduced by means of hydrogen—in the hope that this powder would collect along the magnetized traces left by the soft-iron stylus.

In these conditions, although at first the reinforcement appeared scarcely sensible, it was possible to prove that it existed, in a very original manner, at the wireless laboratory of the Eiffel Tower station at Paris. During the experiment signals from Cleethorpe and from Clifden were heard,

but the disc recorded only the first, which were the loudest. But, after the employment of the powdered iron the Clifden signals were recorded.

Our diagram shows Mr. Dosne's plant. It includes a wireless receiver with a crystal detector; the telephone has been removed and replaced by an amplifier. Finally the Poulsen telegraphone is connected, in the place of the loud-

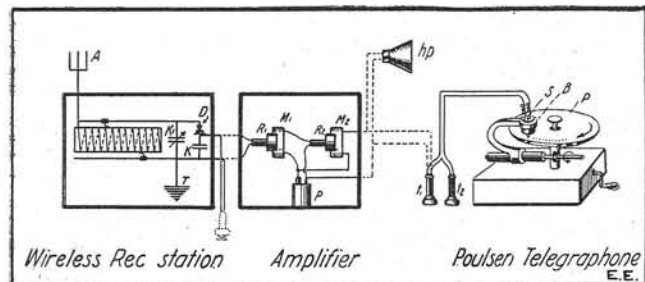

System for Recording Wireless Telegraph Signals on Telegraphone.

speaking telephone, to the amplifier. In these conditions it suffices, to record a message received at an ordinary wireless station, to start the steel disc rotating in order that the fluctuations of the current, passing through the combined telephones and microphones of the amplifier, may determine in the coil of the Poulsen apparatus a variable magnetic field, of which the little soft-iron needle constituting the core of the coil forms a part.

The message is read by placing the ear at one of the telephones of the Poulsen apparatus, which, after the registration, behave like simple receivers and repeat the message.

It should be noted that the speed of recording a message may be modified for repetition. In fact, the disc may be made to turn at a greatly reduced speed if one is not well trained in sound-reading; but in this case the signals lose in intensity. On the other hand, if the speed of reception is greater than that of record, the signals gain in power.

The same disc may serve indefinitely if it is not desired to preserve the record.

(A) Antenna. (D) Crystal Detector. (T) Earth. (K) Fixed Condenser. (K1) Adjustable Condenser. (R1) Prime Receiver. (M1) Its Microphone. (R2) Secondary Receiver. (M2) Its Microphone. (P) Steel Plate. (B) Poulsen Coil. (S) Soft-steel Needle. (t1-t2) Receiving Telephones.

Imagine a dead piece of metal, with no visual indication of how it is accomplished, holding human speech imprisoned in its cold confines and music and sound vital to the progress and enlightenment of the world!

THE VOICE IS STORED IN MOLECULES OF METAL. And here is a baffling mystery in this storage. Precisely what the nature of it is man shall not know, we are told by authority, until the mystery of magnetism is fully solved.

The wizard responsible for the new and wonderful discovery is named Dosne, and Lucien Fournier, in describing his achievement, naturally speaks first of Poulsen's earliest model. It was then constituted by a bobbin of steel wire which was made to turn under a receiving coil. The wire records speech magnetically and it is reproduced in a telephone receiver when the coil that has been influenced passes a second time under this receiver.

The device used by Mr. Dosne differs from this early model by replacing the steel wire with a steel disc turning under a light soft-iron needle forming part of the electro-magnetic receiver of the apparatus. This apparatus moves from the edge to the center of the disc during the inscription, so that the record is spiral, like that on a graphophone disc.

The Poulsen device cannot be used for recording wireless signals; the coil connected with the needle planned for use as a telephone record needs modification for adaptation to the new kind of work required of it. Mr. Dosne has taken account

CONCERNING GROUND ANTENNAE.

It may be interesting for the amateur radio readers of your magazine to know what success I am having using a ground antenna.

I laid two stretches of No. 18 insulated bell wire directly on the surface of the ground in my back yard (in Boston), the length of each stretch being about 25 feet. The lead-in was taken from the middle, thus forming the shape of a "T." The instruments I use are a single-slide home-made tuner, galena detector, 75-ohm telephone receiver and an E. I. Co. loading coil. With this aerial I receive the Boston Navy Yard and a number of stations around the harbor. I had some correspondence with an experimental radio station here regarding this "ground antenna," and they advised me that this type of aerial has a directional effect; that is, if it runs due north and south, stations east and west cannot be heard. I advised them that my aerial runs directly sideways to the Boston Navy Yard and I receive messages right along from this station. They wrote and told me that my not encountering directional effect with this ground antenna is due to one of two things—either the wires are so far short of the proper length that I get forced oscillations, or else there are local electric wires that neutralize the actual direction of my wires. I shall be pleased to hear from any amateur who experiments with this type of aerial. Contributed by

P. J. LEARY.

NEW ORLEANS RADIO OPERATORS MAKE FINE RECORD.

Complete success greeted the recent initial attempt of the radio operators at the New Orleans Naval Station to flash a message to the Government wireless station at Darien, C. Z.

The test message was sent at 10 o'clock in the morning, and Chief Operator McKean, of the local naval station, had no difficulty in communicating with the men in charge of the station on the Canal Zone. The distance between here and Darien is approximately 1,600 miles, and the operator on the Canal Zone stated that the signals from New Orleans were so strong as to almost affect the ear drums.

The sending of the long-distance message to the Panama Canal by the New Orleans Naval Station marked an epoch in Government radio circles. It means that the final link in a chain of wireless stations to connect the United States and points in the tropics, as well as our possessions in the Pacific, has been completed.

Two 300-foot steel towers and an exceptionally powerful set contribute in making the New Orleans radio station one of the best yet completed. A force of 16 operators will be required in handling the radio equipment when the station has been brought up to its full strength, it is said. Most of the dispatches flashed through the air from the ships in Mexican and other tropical waters are expected to be handled directly through New Orleans.

THE SMALLEST LOOSE COUPLER.

What is probably the smallest loose coupler ever built and suitable for actually receiving wireless signals is shown in the photograph. It is perceived resting on top

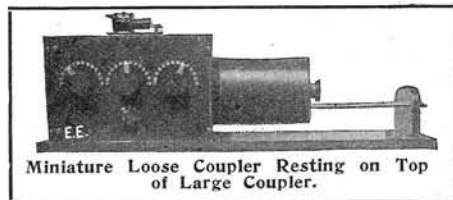

Miniature Loose Coupler Resting on Top of Large Coupler.

of the large coupler, which latter measures about 2 feet in length. The large coupler is fitted with three primary switches, and same is capable of tuning in wave lengths up to 9,000 meters when used with a fair-size aerial. The miniature loose coupler resting on top of the larger instrument is

so small that it will fit in the hand nicely without projecting beyond the fingers. It is complete in every way, being fitted with a primary tuning slider as well as with a six-point switch on the movable secondary, accurately wound with comparatively fine magnet wire. This small coupler has been used a number of times and operates very efficiently in bringing in wireless signals. It is capable of tuning in wave lengths up to about 200 meters when used with a small-size antenna.

HOW WIRELESS WAVES TRAVEL AROUND THE EARTH'S CURVATURE.

MOST people probably do not stop to consider what a great depth of earth exists between two modern long distance radio-telegraphic stations

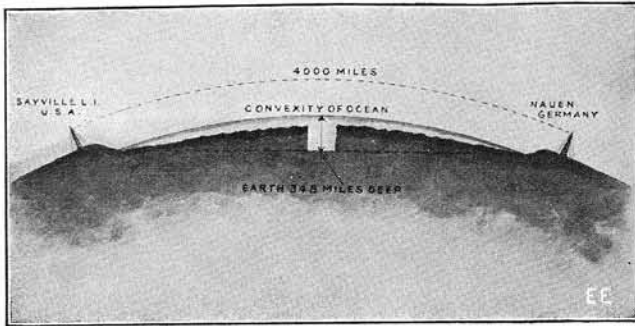

Fig. 1. Illustrating the Vast Depth of Earth Between Two Transatlantic Radio Stations.

when they are in communication with each other as, for instance, is the case between Sayville, L. I., U. S. A., and Nauen, Germany, located near Berlin. The approximate distance between these two modern high powered wireless stations is 4,000 miles and, as Fig. 1 shows, the curvature of earth lying between these two stations has a chord height of 348 miles. At either station the lofty steel towers supporting the aerial wires, from which the waves are liberated or sent out, only have a height of from 600 to 800 feet in any case. This, of course, is a very, very small percentage of the depth of the earth's curvature intervening between the two stations, as will be perceived.

Several theories have been brought forth from time to time in the progress of the radio art as to the probable method by which such long distance wireless telegraphic signals are propagated around one-fifth and even one-quarter or more of the earth's circumference. Many scientists claim that the waves glide over the surface of the earth, as shown in Fig. 2 at A A A. This is based on the consideration that the earth's surface acts as a charged conductor and thus serves to guide the waves, so to speak, in their path between the stations. Of course, the waves radiate, practically speaking, equally in all directions from a given point (as about an aerial) in the form of a circle. Only the half loops are supposed to glide over the surface of the earth, as Fig. 2 indicates; the

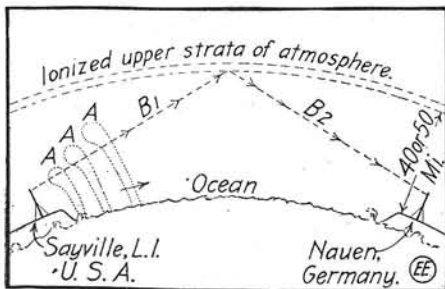

Fig. 2. Diagram Showing How Wireless Waves Are Propagated Over the Earth's Surface.

complement half waves of those shown being, of course, in the earth proper.

It was formerly believed in the early days of wireless telegraphy that the wireless signals were propagated between stations (which were located sufficiently far apart so that the most of one could not be seen at the second station) by means of what was termed the "bound" ether, locked up or permeating the earth itself and also

AMERICAN RADIO LEAGUE WIRELESS STATION.

By Frank C. Perkins.

The accompanying illustration shows the equipment of the American Radio League relay wireless station. This station is in operation at New Rochelle, N. Y. The aerial is of the inverted "L" type, having an average (two wire) height of about 65 feet and a length of 180 feet. All the parts of the aerial are extremely well insulated and very strongly installed to prevent damage by wind and sleet. Standard phosphor bronze wire and commercial insulators are used.

It may be stated that the transmitting set consists of a 1-kw. transmitter, with a condenser capacity of .006 mfd. (three standard Navy jars in parallel). The rotary gap employed has 12 moving points and two stationary electrodes and turns at 8,000 R.P.M. This allows the use of the above small condensers and gives the short wave necessary for 200-meter work in the primary circuit, which together with close tuning through an efficient oscillation transformer, with fair looseness of coupling, allows heavy radiation on a single peaked wave.

It is held that repeated tests show a transmitting range of between 350 and 400 miles under any sort of normal conditions. Un-

der very good atmospheric conditions 800 to 1,000 miles is not at all difficult with this set. The transmitter is contained in a polished wood cabinet, a corner of which may be seen in the extreme left of the picture.

all other solid bodies with which we come in contact daily. According to the latest scientific theories of all bodies, even including cast iron, steel, etc., these really consist in great part of etheric electrons; the relative percentage of solid particles in same being extremely small. This theory was at one time strongly advocated by the famous English scientist and investigator, Sir Oliver Lodge.

After much research and experimental work, which has progressed sufficiently to give some basis upon which to stand, some of the leading scientists of the day, including Dr. J. A. Fleming and others, now hold to the reflected wave theory to account for long distance radio telegraphy.

This is supposed to take place as follows: As we know, the atmosphere of the earth, roughly speaking, extends upward to a depth of 40 or 50 miles. At these high altitudes the atmosphere becomes very highly rarefied and it is suspected that a very strong ionization of the electrons in these upper strata of the atmosphere takes place. This electrification of the upper strata is caused by the electro-magnetic effect of the sun's rays, according to these theories.

It is believed that, considering such long distance radio transmission as 4,000 miles, the etheric waves, as propagated from a station like Sayville, L. I., strikes upward, due to the earth's curvature. The waves are then reflected from the highly ionized upper strata of the atmosphere; also it is thought further that the reflected wave, such as at B², is the one that is intercepted at the distant receiving station, say at Nauen, Germany,

There is a special loose coupler used for waves up to 3,000 meters or a little over. This loose coupler has a very long secondary of high inductance value, which permits tuning without using much capacity across the secondary in that circuit; practically no capacity is used and this method has been found to permit of much longer distance in working, especially with audions. Also the loading coils used load both primary and secondary, and particularly endeavor to balance up the secondary circuit with the use of very little capacity. This method is one of the secrets of the remarkable sensitiveness of this set.

It is of interest to note that No. 24 wire is used for both primary and secondary of the loose coupler. A two-step amplifier of the Audion type is used in connection with an Audion detector. This amplifier embodies some original ideas in its details of construction.

It is pointed out that there is an original arrangement of knob switches in the amplifier circuit that allows (for the first

time in actual practise) a change from the receiving on the detector alone to any step of the amplification instantly, without removing and replacing telephones or disturbing any adjustments. This method of producing instantaneous amplification and the reverse is of great convenience and importance. The whole station was designed with the idea of service on long-distance radio "relay" work, and is remarkably efficient in operation. A comparison of effects may be had by noting that Key West station, NAR, can be heard and copied easily 15 feet from the ordinary telephones, while Arlington, NAA, has been copied over 100 feet distant from a loud-speaking telephone when this was hooked up in the circuit. Regular work has been done with stations using 1-inch coils at a distance of nearly 50 miles.

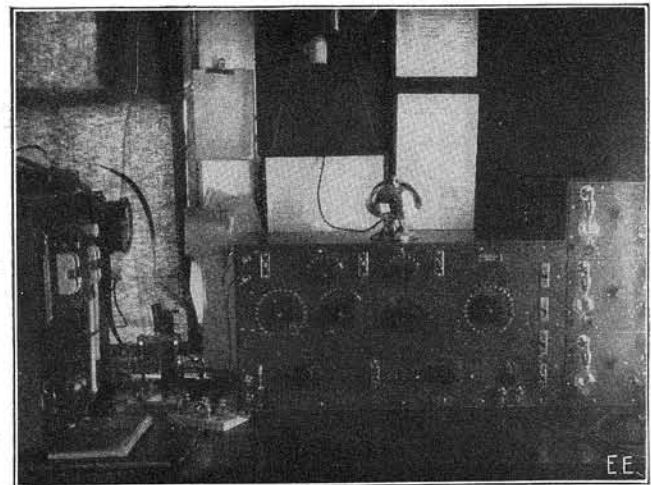

Excellent Radio Relay Station of the American Radio League, at New Rochelle, N. Y.

TO INSTALL WIRELESS AT CHICKASHA, OKLA., HIGH SCHOOL.

The Chickasha (Okla.) High School will install a wireless telegraph dispatching and receiving station for use in the school work. The station will have sufficient power to receive messages from the Arlington wireless station on the Eastern coast and from ships 300 miles out in the Gulf of Mexico. The station is now ready for business.

How to Build a Wave Meter

By Samuel Cohen

MANY radio experimenters have an idea that the construction and manipulation of a wave meter is a difficult matter and therefore they do not usually build one. However, the construc-

tions, as shown in Fig. 2. The rotary plate shaft (3-16-inch diameter stock) is shown in Fig. 3 and stationary plate rods, of which there are three, are made in the same manner, as is shown in Fig. 4. Two

turns close together. The second or larger coil consists of 72 turns of the same size magnet wire, wound on evenly, with the turns close together. The coils may receive a few coats of black shellac to help hold the windings firmly in place. It is also a good idea to bind the coils with white linen tape or with cord, so as to protect the wire from injury.

Both coils are provided with two brass or copper attachment straps L. The drawing at Fig. 8 indicates how these plugs are attached to the cardboard tubes by simply bending one end of them over as indicated, and a No. 6-32 machine screw is passed through a hole in the other side of the cardboard ring into a tapped hole in the brass strip. These strips should be about 1½ inches apart, and the two terminals of the coil in either case soldered to them, one terminal to each plug. The slots in the ends of the strips are fitted, of course, to the binding post of the wave meter at A¹, B¹.

These inductances correspond to those made by the writer and which are designed from standards as made up and tested on a Siemens & Halske inductance bridge at the radio laboratory of the College of the City of New York. The small or 12-turn coil has 36,000 cms. inductance, while the 72-turn coil has 1,036,000 cms. inductance.

Fig. 9 depicts three curves plotted for different wave lengths, corresponding to different condenser readings. Curve 1 was plotted with the small inductance coil, while curves 2 and 3 represent the use of the large inductance coil. It is very easy then to determine the resonance points of the wave meter by reading the scale setting of the condenser and referring to the curves herewith reproduced. Care should be taken not to use the wrong curve, as they have entirely different values.

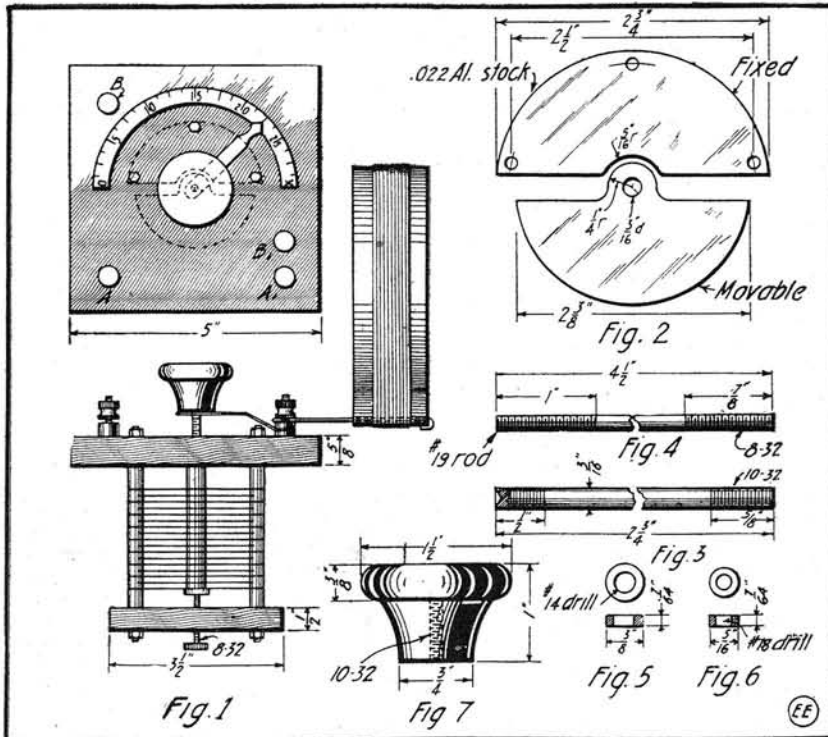

Details of Wave Meter Condenser and Inductances.

tion and operation of a wave meter is so simple that the novice operator may use it.

First and foremost, a wave meter is an instrument comprising an inductance and a variable capacity and an indicating device, such as a telephone receiver or vacuum tube.

This article deals with the construction of a wave meter, which was recently built and calibrated by the writer. The builder of this instrument does not necessarily need to calibrate his wave meter, but he should construct it according to dimensions given.

sets of washers are constructed, namely, the rotary plate washers, as shown in Fig. 5, and the stationary plate washers, as Fig. 6 illustrates. When all these parts have been made accurately assemble the condenser, Fig. 1. The rotary plates are regulated by means of an 8-32 set screw. The knob, Fig. 7, is made of any insulating material, preferably hard rubber.

This variable condenser has its 180° scale marked off in 30 equal divisions. Its maximum capacity with the rotary plates totally intermeshed with the fixed plates is .000795 micro-farads. At 15 scale divisions the capacity would be half this value in microfarads. The wave length can be calculated from the usual formula:

W.L. in meters = $59.6 \times \sqrt{L \text{ cms.} \times C \text{ m.f.}}$

We now come to the inductance coils, of which there are two. These are shown in detail as to their make-up at Fig. 8, and some substantial cardboard tubing or wooden rings are to be used, which have an exact outside diameter of 5¼ inches. Two such "forms" or rings are necessary and the smaller inductance coil consists of 12 turns of No. 20 B. & S. enameled magnet wire, wound on very evenly, with the

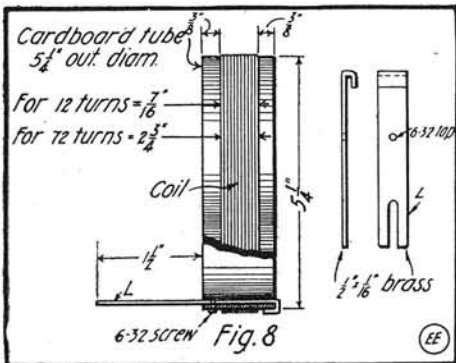

Fig. 8. Inductance Coil Make-Up.

The writer advises the consultation of a good text-book treating on the manipulation and construction of these meters before building such an instrument.

The first thing to build is the condenser, which is of the rotary air dielectric type. Very little explanation is necessary for the description of this condenser, as all the details are plain and self-explanatory. Fifteen rotary and 16 fixed plates of No. 20 B. & S. gauge aluminum are made according to

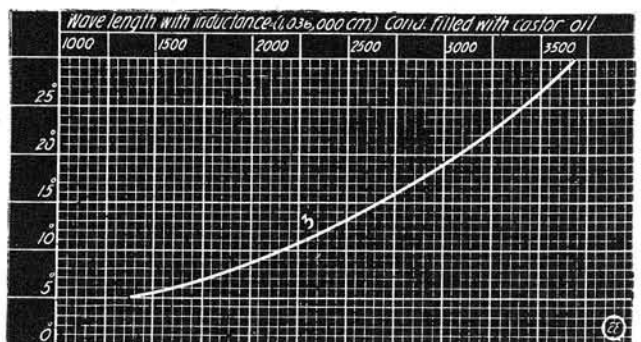
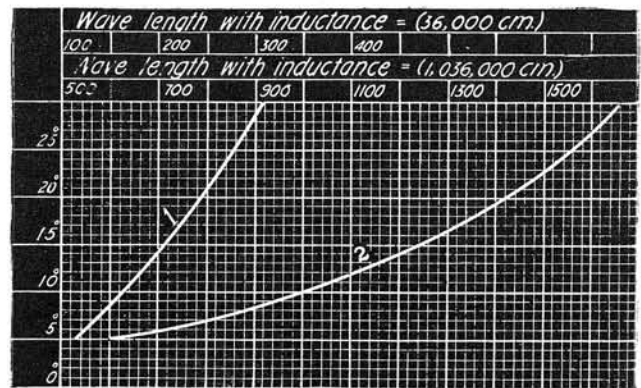

Fig. 9. Wave Length Inductance and Capacity Curves for Use With Wave Meter.

The curve No. 3 was plotted for those desiring to measure waves up to 3,500 me-

ters.

ters in length or more. To use this curve and its equivalent wave lengths as given, the variable condenser of the wave meter must be placed in a glass or other jar, so that the moving and fixed plates will be immersed in castor oil. This raises the capacity of the condenser about five times, and hence gives us greater wave length

material, preferably hard rubber, and turned out in a lathe. The dimensions are given. Next mark out a circle having a radius of 1 3/8 inches and on it lay out evenly 20 points, and then set in them 20 brass nails having 3/8-inch shank. After having done this obtain a 1-inch brass or copper washer C and mount it carefully on the circle, as shown.

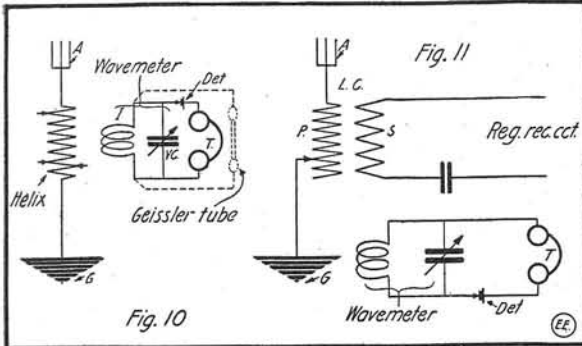

Figs. 10 and 11. Diagrams for Using Wave Meter on Transmitting and Receiving Circuits.

ranges with the same inductance coil, i. e., 72-turn coil, with 1,036,000 cms.

The diagrams at Figs. 10 and 11 indicate how the wave meter is hooked up. At Fig. 10, used, say for measuring the sending wave length, the inductance coil I of the meter is held just close enough to the sending helix so that a readable sound is heard in the telephone receivers T. The variable condenser is regulated or turned until the loudest signals are heard. This is the point of resonance in the wave meter circuit, and the corresponding wave length value for this setting of the condenser is read off from the curve 9. If the condenser reading was, say 20 degrees with the large inductance coil in use, then by noting the wave length vertical line intersecting the curve 2 (for large inductance) and the (air) condenser horizontal line, it is seen that the wave length is 1,420 meters.

In a similar way the wave length is measured at a receiving station (see Fig. 11). The wave meter inductance coil is placed in sufficiently close proximity to the loose coupler coils until the incoming signals can be heard in the meter 'phones. The variable condenser is then turned until the signals are heard loudest and this condenser setting in degrees, referred to the curves in Fig. 9 as explained above, gives the equivalent wave length in meters.

Another common method in vogue for measuring received signal wave lengths is as follows: When a certain station is tuned in sharpest on the regular receiving set the instruments are left alone as they set. Then the wave meter is brought near the coupler, etc., and by exciting the wave meter circuit (by connecting a buzzer vibrator across it) it is possible to hear the meter oscillations by induction in the 'phones of the regular receiving set. When the meter signals are heard loudest, then it is set to the wave length corresponding to the setting of the receiving apparatus.

From the data here given it is possible to easily build a wave meter with any rotary condenser, using the standard inductances here cited.

LOADING COIL MOUNTED ON SLIDER.

A miniature loading coil which is placed on top of the loose coupler slider can readily be made, and at the same time have a fairly large wave length. This instrument has been tested out in several commercial radio stations very successfully.

By referring to the drawings herewith given the construction will be quite evident. First comes a circular form A, Fig. 1, which is made of some insulating ma-

terial, preferably hard rubber, and turned out in a lathe. The dimensions are given. It is fastened in place by means of three brass screws. This ring is used to connect one of the end connections of the winding by a brush, as shown in Fig. 1.

A 1/4-inch hole is next drilled in the center of the reel A, and into it force a brass tube 3/4 inch long having an internal diameter of 1/2 inch. Into this brass tube the shaft D is placed, which is made from brass stock, and details are shown in Fig. 2. The contact maker is now made as in drawing 3, which is then soldered to the shaft as seen.

Now, being finished with all the necessary details, the winding is next to be considered. There are 20 sections to be wound on the coil. The first winding consists of 10 turns of No. 36 D. C. magnet wire.

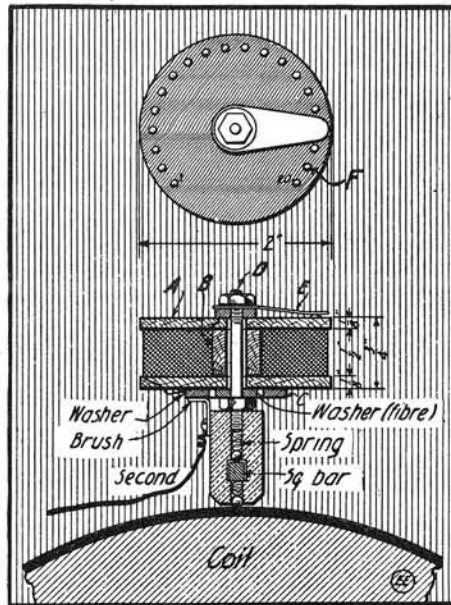

Loading Coil Mounted on Tuner Slider.

The one end of this coil is brought to the brass washer C and firmly soldered, while the other end is soldered to the shank of the first brass tack. The second winding consists of 15 turns of the same wire, and the connections are made with the first tack, while the other joins on to the second tack. All the other windings are made in the same way, and each winding is increased by five turns.

The shaft is then screwed on the slider and carefully adjusted to see that the coil rotates easily and that the switch blade makes contact with each point.

Now connect the aerial wire to the brush binding post, while the coil end wire joins the regular receiving circuit. By turning the reel the wave length is regulated, and also the slider can be moved back and forth. This method of tuning is very efficient and at the same time saves some space, besides enabling two operations to be accomplished by the hand in one position.

[This device has been developed by the Eugene T. Turney Co., which has patents pending on it.]

ELECTRIC VARNISH.

Powder some common sealing wax in a mortar, place the fragments in a bottle and cover with alcohol. Keep in a warm place until all the sealing wax is dissolved. This varnish may be used to cover magnets and other parts of electrical apparatus.

Electric Cement.

Melt equal parts of beeswax and rosin together and stir in one-fourth of their weight of red ochre, stirring until well mixed. This cement is used for fastening the metal portions of electrical instruments to their insulating supports, etc.

Contributed by ALEXANDER V. BOLLERER.

THAT LIGHTNING SWITCH.

Every good amateur wireless station has a lightning switch to ground the aerial with. The switch is used because it dissipates static aerial currents before they have had time to accumulate into a heavy charge, and thus prevents damage to the building and apparatus.

The wire from the switch to earth should be a No. 4 B. & S. (about 1/4 inch diameter) copper conductor, connected on the outside of the building and taking a straight course to the ground proper.

This "ground" should consist of a 12-foot by 1-inch diameter iron pipe driven into moist earth, or a 10-inch square piece of copper buried 6 feet deep. Some amateurs use a connection made to a well-pump (iron pipe), but in any case the connection must be soldered and taped.

A 100-ampere, 250 or 600-volt S. P. D. T. switch is specified, with the aerial connected to the blade, the ground to one jaw and the apparatus to the other jaw. This switch may be obtained from any electrical supply company, but in order to stand the sending voltage the base should preferably be made of marble or porcelain. The cheapest way to do this is to buy a slate-base switch and remount on marble yourself.

If the aerial proper is composed of four No. 14 copper wires, then the lead-in should consist of four No. 14 copper wires or a No. 6 B. & S. solid wire, stranded cable being best, of course.

In order to protect the switch from being broken, it should be fastened with screws in a box with a hinged cover, and the lead-in fastened by an insulator before it reaches the switch.

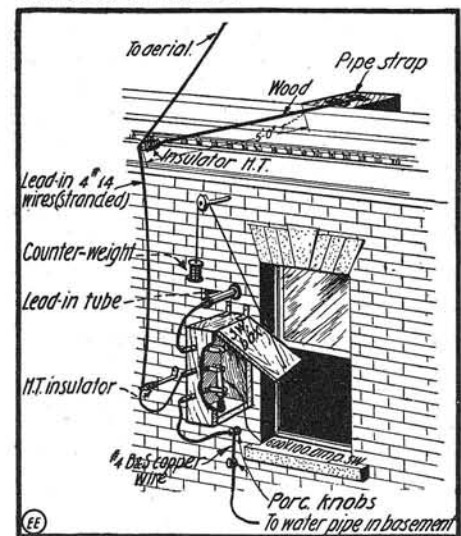

Practical Method of Installing Lightning Switch.

Rain can be prevented from running down the lead-in by making a half loop in it. Contributed by

WM. R. COTTRELL.

AN EFFICIENT DETECTOR.

I give herewith sketch and description of a simple yet efficient detector, made from a double-pole single-throw switch, which I am sure will be found useful to the amateur.

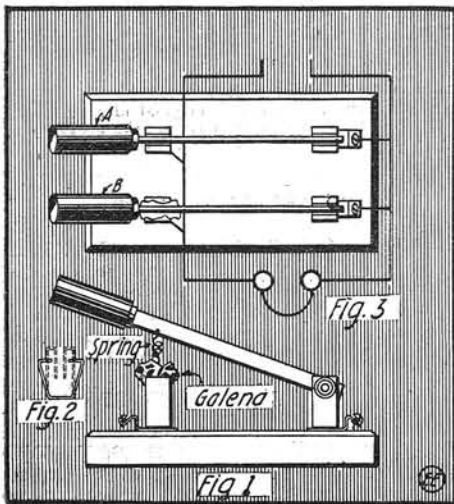

Detector Made From Knife Switch.

Procure a double-pole, single-throw knife switch; unscrew the hinge post and place a washer between the base and post, so as to allow the switch blade to be swung from side to side to facilitate the adjustment. Before replacing the switch blade, solder on it a fine wire coil of either phosphor-bronze or brass, to make contact with the crystal. Now take jaw post and bend it into shape to hold the crystal, as shown in Fig. 2.

This completes the detector; the other switch being used to short-circuit the detector while sending or it may also be converted into a detector. If the constructor has means of short-circuiting the detector on the antenna switch, and does not need the added detector, he may use a single pole, single throw switch, and will not have to change blades, as in the case of the double-pole, single throw switch, where the double blade will have to be substituted by the single blades. Connections are shown.

Contributed by WILLIAM GUIER.

A HANDY AERIAL SWITCH.

The following instructions will be found very serviceable for constructing an efficient and simple aerial switch at a very nominal cost. This switch may be thrown

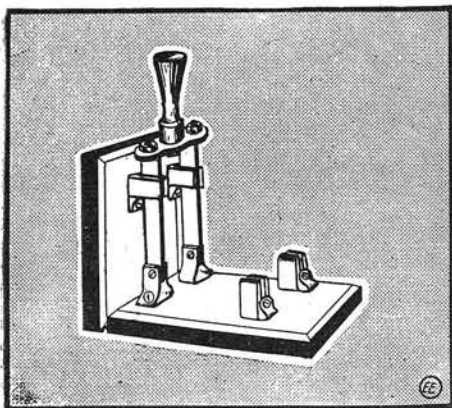

Aerial Switch Composed of 2 D.P.S.T. Knife Switches.

from transmitting to receiving, and vice-versa, very quickly and satisfactorily.

Obtain two double pole, single throw switches and from one remove the arm and place the lugs over the arm and lugs

A HOME-MADE TUNING COIL.

The amateur is often hampered by the lack of funds and therefore the tuning coil herewith described will be found beneficial in overcoming this embarrassment.

First a cylinder 4 inches in diameter is made from cardboard and coated with paraffine to insure perfect insulation, or, better still, a wooden cylinder may be used. This cylinder should be 11 inches long and wound with a layer of 20 to 22 copper wires with cotton covering. (Enamel wire will also be found effectual). A rod is now heated red hot and drawn along the coil, thus burning off the cotton insulation in two straight lines, each about 1/4 inch wide; these bare strips forming paths where the sliders make contact. For enamel insulation sand paper serves to remove the coating along the slider paths.

A convenient size frame of 1/2-inch stock is then constructed, across the ends of which are placed two brass slider rods, with a slider on each. These sliders are made from pieces of brass or copper with holes to fit the rod, contact being produced by fastening (soldering) a strip of spring brass or copper onto the under side; while at the top a piece of hard rubber should be firmly fixed to prevent the coil from being grounded through the body. (Sliders can be purchased very cheaply from any supply house). The binding posts can be procured from old dry cells, and in the drawing herewith is shown the make-up, there being four terminals. By properly following the above directions, good results may be realized with this coil.

Contributed by

SAMUEL F. DUNN.

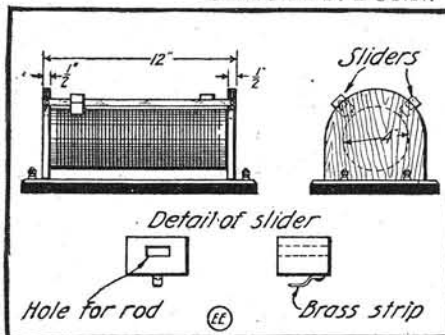

A Home-Made Tuning Coil.

SMOKE STACK SUPPORTS WIRELESS AERIALS.

The big smoke stack at the Brush Electric Co.'s power plant at Galveston, Tex., was probably never intended by its designer to be used as a mast to hold wireless aerials, but it has proved a wonderfully good thing for the purpose, and messages are now being transmitted from the top of the smoke stack to points as far away as Vera Cruz.

Except for the wireless in the army transport Buford, which was in continuous operation all through the recent storm, the Marconi wireless plant at the Brush power house was the only wireless in the city connecting Galveston with the outside world.

The Marconi aerials went down during the height of the storm and Manager Campbell immediately got busy looking for another place from which to operate.

of the other. Then tighten to whatever pressure desired. Set the switches at right angles and fasten to either a wall or table. If desired, a special base may be made for this purpose, as sketch indicates. This should be composed of a block of wood, 1/2 x 3 1/2 x 6 inches long, screwed at right angles to another block, 1/2 x 3 1/2 x 6 1/2 inches long, the corners of which may be beveled to produce a neater effect. Contributed by D. K. WALKER.

A HANDY DETECTOR SWITCH.

I have found the following switch very desirable for throwing one of a number of detectors into circuit.

This can be easily made by placing some exploded cartridge shells on a wooden base, as shown in sketch, and connecting these to the two pieces of brass by means of the brass strips, indicated in sketch

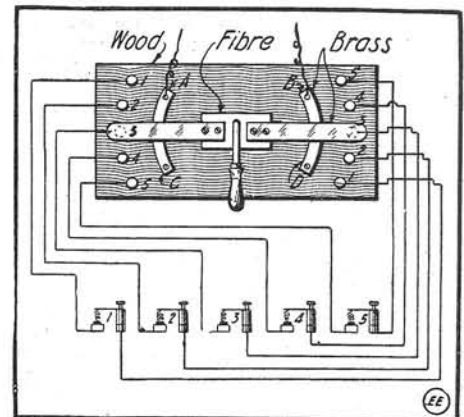

Unique Detector Switch.

attached. The sliding brass strips are riveted onto a piece of sheet fiber, through which is bored a hole. A rod is passed through and connected to the wood base. It is then bent, and if desired a handle may be attached.

The figures from 1 to 5 represent the bullet shells and numbers of detectors; and the letters A, B are the connections for the phones and instruments.

Contributed by GORDON SCHAUB.

A SIMPLE TUNER SLIDER.

The following articles are required to make this handy little slider:

A piece of hard wood 7/8 in. x 3/4 in. x 3/4 in., in which a groove 1/4 in. x 1/4 in. is cut to allow slider to pass through. A sheet of tin or copper 7/8 in. x 3/4 in. is fitted over this groove, and screwed or nailed on, as the constructor sees fit. On this is soldered the slider contact, which has been properly shaped and a 1/2 in. projection allowed, in order to make contact with rod.

This slider works very easily when the slider contact is made of a thin but flexible piece of brass or phosphor bronze. The hard wood handle is now given a coat of shellac and the slider is ready for use.

Contributed by

CARL LINXWEILER.

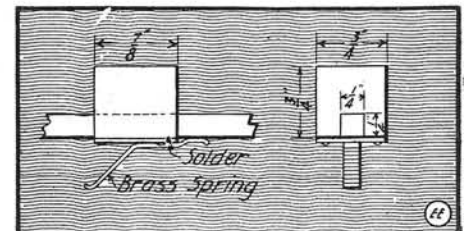

Tuning Coil Slider Made from Wood.

THE CHAMPAIGN, ILL., WIRELESS CLUB.

The Champaign Wireless Club, of Champaign, Ill., was organized Aug. 4, 1915. It has nine members: Maurice Lee, president; Walter Thornhill, vice-president; Joseph Tipiword, secretary; Ernest Mills, treasurer, and T. McHowen, S. Hall, S. Bostic, O. Bucker and N. Chatman.

HOW TO MAKE IT



This department will award the following monthly prizes: FIRST PRIZE, \$3.00; SECOND PRIZE, \$2.00; THIRD PRIZE, \$1.00. The idea of this department is to accomplish new things with old apparatus or old material, and for the most useful, practical and original idea submitted to the Editors of this department, a monthly series of prizes will be awarded. For the best ideas submitted a prize of \$3.00 will be given; for the second best idea a \$2.00 prize, and for the third best a prize of \$1.00. The article need not be very elaborate, and rough sketches are sufficient. We will make the mechanical drawings.

FIRST PRIZE \$3.00.

AN ELECTRIC SOLDERING IRON.

The following is an electric soldering iron that I have found very useful and particularly accessible for niches, corners or tight places, as well as for use in ordinary soldering.

At A is a small carbon pencil, forced into the end of a copper tube B. C is a small wooden file handle, drilled out, so that the copper tube can slide in snugly.

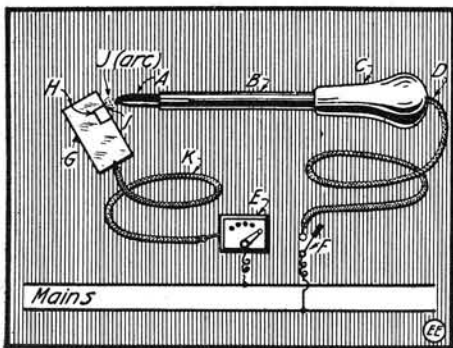

Arc Type Electric Soldering Iron.

At D is seen a single covered conductor, soldered on the copper tube B. A small variable resistance coil to regulate the current is depicted at E, while F shows a switch for breaking the circuit. G is the piece that the article H is to be soldered to and I represents the soldering flux; or if desired, solder may be used with acid, provided a small piece is cut off and placed on the article to be soldered. At J is shown the "arc" formed by closing the circuit and holding directly over the article to be soldered. K is another insulated wire to be grounded to the article being soldered.

This iron may be made either large or small, as the builder sees fit. I have had fair success with it and feel sure that other amateurs will also find it efficient.

Contributed by

HAROLD SPAULDING.

TO BORE HOLES IN GLASS.

The following method of making perforations through glass may be of interest:

Take an old triangular file and break off its tip about 1/2 in. from the end. Place the shank end of the file in a brace and use it as a drill. The glass should be drilled slowly, using kerosene as a lubricant. At first it may be found rather difficult, but after once starting the shape of the file causes it to act as a reamer.

Contributed by W. R. COTTRELL.

FURNITURE POLISH.

Herewith is submitted a formula for making a cheap furniture polish, which will be found very efficacious: One-half gallon gasoline, 1/2 gallon light lubricating oil, 2 drops of oil of cedar.

Contributed by MONROE MILAN.

SECOND PRIZE \$2.00.

AN AUTOMATIC TRANSMITTING KEY.

I give below a description of an automatic key, which, although it may appear complicated, is really very simple.

The first consideration is the base. This is made of oak 4x7x7/8 inches, with ten 1/8-inch holes, drilled and countersunk, as shown in Fig. 1. The lever A, Fig. 1, is composed of a 1/4-inch square brass rod, drilled and tapped, as shown in Fig. 2. The contacts X and F¹ (Fig. 1) are for dashes. A small silver piece about 1/8 inch in diameter is soldered to the center of the lever, 1/2 inch from the end at "X." The other contact is soldered to the screw in the post F¹. Two inches from the end a 3/16-inch

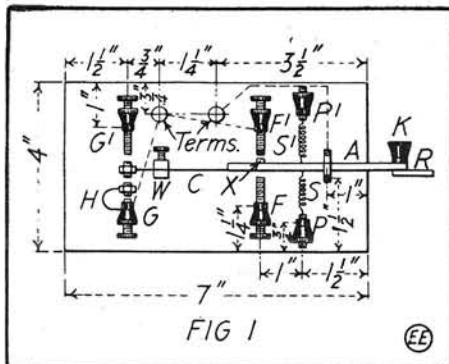
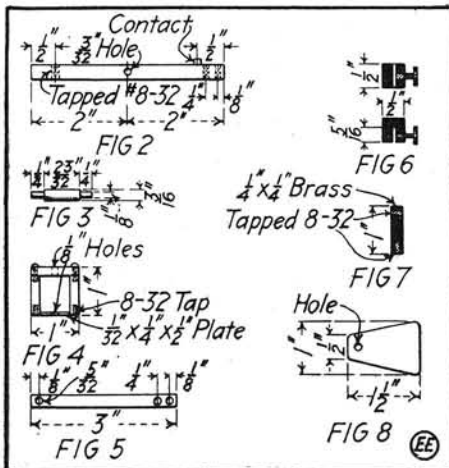

Fig. 1. Assembled Automatic Telegraph Key.

hole is bored, and into this is forced a steel pin, as Fig. 3 depicts. This pin forms the pivot which carries the lever. The bearings are shown in Fig. 4, while R, Fig. 1, is a piece of 1/8-inch hard rubber or fiber sheet, finished as illustrated in Fig. 8. This



Details of Parts for Making Automatic Telegraph Key.

is fastened to the lever by an 8-32 screw 3/4 inch long. At K may be seen a hard rubber key knob.

The spring C, Fig. 1, is made of phosphor

THIRD PRIZE \$1.00.

FUSES FOR BATTERY CIRCUITS.

A small fuse for battery circuits may be made of a small piece of tin-foil. The tin-foil is cut in the form of a narrow strip and connected between two binding posts. Its size will vary according to the current it has to carry. Contributed by

W. R. COTTRELL.

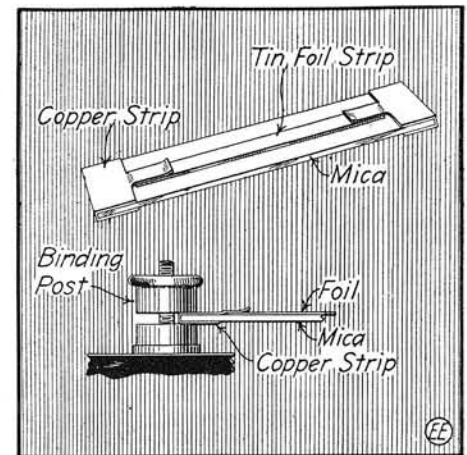

Battery Fuses Made from Tin-Foil and Mica.

phor bronze about No. 32 or 34 B. & S., and measures 3 1/8 x 1/4 inches. This makes contact with a 3/16-inch diameter round piece of silver, soldered into a brass cup and bolted on to the spring through a 3/16-inch diameter hole. The weight W is made of brass, 1/2 x 1/2 x 1/2 inch. A slot is sawed in the center of the bottom 1/8 inch deep. A set-screw is then placed in one side. The spring H is a U-shaped piece of phosphor bronze 1 inch long and 3/8 inch wide. On one side of the "U," the silver contact is soldered and a 3/16-inch hole is drilled in the other side. The spring is fastened by means of an 8-32 screw to the post G. The four posts F, F¹, G, G¹, Fig. 1, are each 1 inch long by 1/4 inch square, as shown in Fig. 7. A 1/8-inch hole is drilled 1/2 inch deep in the bottom of each and tapped for an 8-32 screw. Four 8-32 screws, with knurled heads and lock nuts about 1 inch long, are required for these posts. The posts P and P¹, Fig. 1, are similar to the others, except that a hole 3/16 inch in diameter is drilled through the post at the top. The screws to which the springs are fastened slide in these holes. The two screws are without heads, but are fitted with knurled lock nuts.

The springs S and S¹, Fig. 1, are made of No. 28 phosphor bronze wire. They are 3/8 inch in diameter and 1/2 inch long. One end of each spring is attached to one of the screws and the other end to the lever.

Connections are made between the posts F¹ and G and one binding post; also be-

tween the lever bearing and the other binding post.

The speed at which the signals can be made may be varied by moving the weight W along the spring.

Contributed by J. L. GREEN.

"SAFETY FIRST" ON THE MOTOR-CYCLE.

Here is a simple little attachment, the employment of which will insure riders of motor vehicles against accident when turning sharp corners or when driving through dark roads in the country, or otherwise. This device constitutes a "red" rear lamp and two red arrows, which are brilliantly illuminated by the touch of a button. The construction is as follows:

First make a small-sized wooden cabinet about 7x3x3 inches. Take a piece of cardboard cut to the above dimensions, and with a sharp knife cut out, with the aid of a ruler, two arrows, leaving a square space in the center for the rear light. Then procure some red tissue paper, or better, some red glass and glue firmly against the frame of the arrows and rear lamp on the cardboard; cover and allow to dry. Now screw in three miniature lamp receptacles in the base of the cabinet; fasten the lamps, make

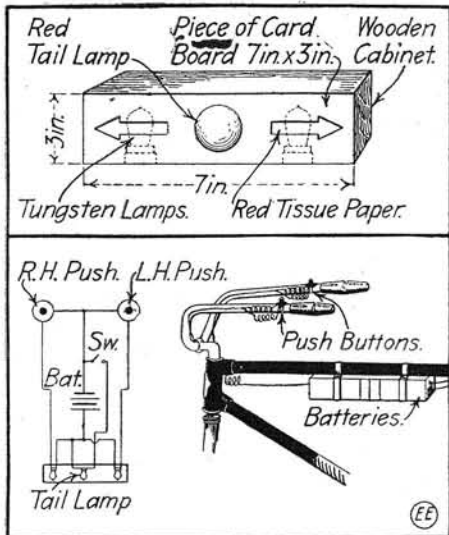

Electric Signal for Tail-End of Bicycles and Motorcycles.

necessary connections and tack the cardboard cover on the frame of cabinet with carpet tacks. The wiring is very simple and the battery may be clamped on the main bar. Two push-buttons, as used on automobiles, are attached to both handle-bars and set in connection with the corresponding light.

Whenever it is desired to turn in a certain direction (either right or left) the corresponding button is pushed; the light flares up and any approaching vehicles or pedestrians are informed of the intentions and whereabouts of said motor vehicle, thereby obviating all danger. Contributed by WILLIAM WARTON.

SIMPLE ELECTRIC EGG BEATER FITS ANY BOWL.

A very simple electric egg beater can be made at home and at small expense, as shown in the drawing. The egg beater is so constructed that it fits bowls of varying sizes, thus adding to its convenience and effectiveness.

All that is needed is a "toy" electric motor and three pieces of stiff wire. One piece for a handle, one for the blades and the third for a leg or support as shown in the illustration. The motor may be oper-

ated by dry batteries or may be attached to the electric light system in circuit with a "bell-ringing" transformer. If batteries are used they should be placed on a shelf or on the back of the table attached to the

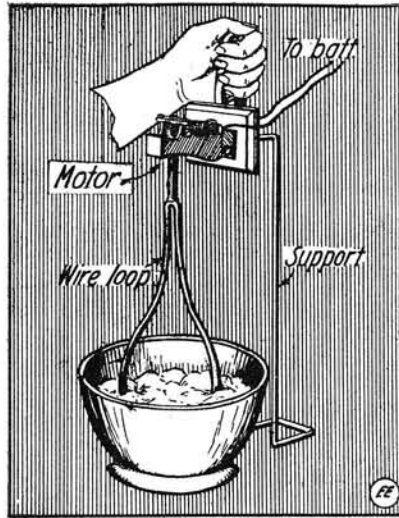

Home-Made Electric Egg-Beater.

motor by a flexible wire of sufficient length to allow the beater to be used on any part of the table. A small switch should be placed on the motor or within reach of the left hand.

This machine will beat any number of eggs in a very short time and it does not get "tired." Contributed by

HAMILTON A. HOOPER.

A USEFUL CARBON BATTERY RHEOSTAT.

Anyone desiring a cheap but extremely efficient rheostat will find that this one will exceed their expectations, both for simplicity of construction and for efficiency in the regulation of battery current.

All that is required to build it is a hard wood baseboard, a number of flashlight or other battery carbons and a switch handle. The carbons are placed in a rectangular compartment made by screwing small strips of wood on both sides and ends of the space they occupy. A strip of wood may be laid across the top to prevent them

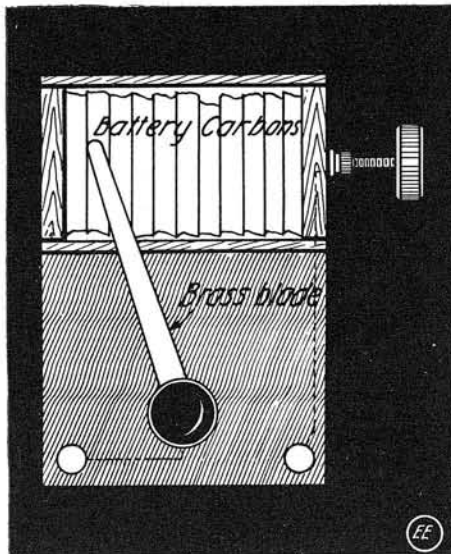

Old Battery Carbons Form Useful Rheostat.

from being forced out of place. A hole is then drilled on one side, into which a threaded brass rod is tightly fitted. This

rod must have a knurled thumb nut with which to turn it. A brass nut should first be put on the rod, to which is soldered the wire for connection with the binding post.

The switch handle is now placed in the center of the remaining space; a block of sufficient thickness being set under it to bring it on a level with the upper surface of the carbons, i.e., with the end of the lever resting on them. Any number of carbons may be used, but it has been found that the more employed the more sensitive will be the regulator.

The regulating screw must come in contact with the carbon near it, or the connection may be made from the carbon itself. By sliding the lever over the carbons, different resistances may be obtained nicely, while the screw serves to adjust each step with fine precision.

Contributed by SELMER WICK.

THE MAGNETO ELECTRIC DOOR BELL.

The disadvantages of the common electric door bell often outweigh its advantages. The batteries are continually running down, due to excessive use or a short circuit, and the button seems to be an irresistible temptation to every youngster

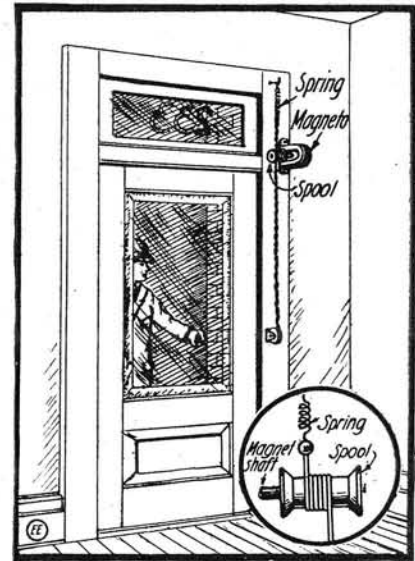

A Magneto Door Bell Saves Batteries.

who delights in sticking a pin in it to keep the bell ringing. Although the bell-ringing transformer does away with battery trouble, it leaves much to be desired.

To eliminate all these mishaps I have designed an easily constructed magneto door bell. Purchase a second-hand magneto and a polarized bell. Remove the two brass gears from the magneto and put a small spool on the shaft of the magneto.

The magneto is mounted above the door as per sketch and a cord fastened to the regular pull bell is passed around the spool several times, a tack is driven in to keep it from slipping and the free end of the cord is fastened to a strong spring, hooked into a screw-eye, and screwed into the top of the door frame. Wires are run from the magneto to the bell, which is located in any convenient place. These wires may be quite small, as the bell will ring through an enormous resistance.

A study of the diagram will show that a pull on the handle of the bell will spin the magneto armature and when the handle is released the spring will pull it back, ringing the bell in both cases. Contributed by THOMAS W. BENSON.

ELECTROCUTION TRAP FOR INSECTS.

A German inventor has devised a very interesting electrocution trap for insects. Upon an insulated frame of either prismatic or globular form two naked metallic

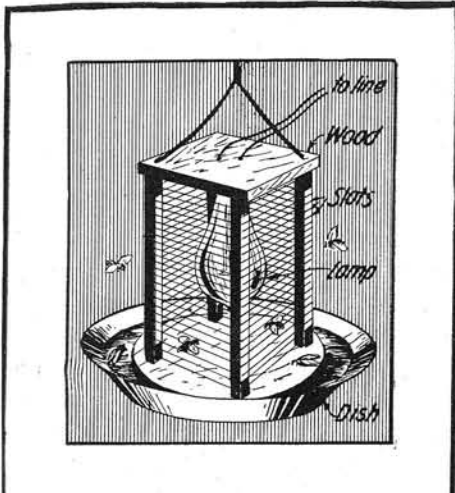

One Type of Electric Insect Destroyer.

conductors are coiled in a spiral with about $\frac{1}{8}$ inch or less space between the windings. The two conductors are connected with a source of electricity in such a manner that the current cannot circulate until it is actually used in killing an insect. This is one of the advantages of the apparatus; obviously no electrical energy is wasted.

Insects are attracted either with sugar water or any other sweet substance. At night time electric lights can be used. The glare of shining metallic parts will also serve as an additional attraction. As soon as the insects touch the bait or the light, and come in contact with any two of the naked wires, they are electrocuted at once and drop down to the bottom of the trap. The current passes only for an instant and is very feeble.

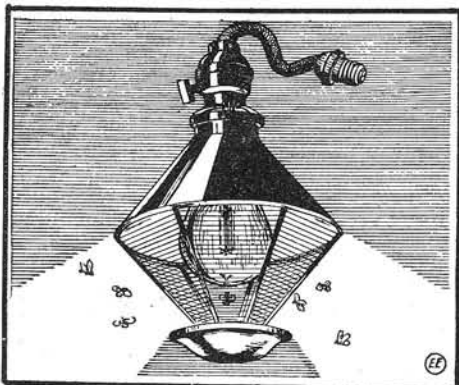

Another Form of Electric Insect Trap.

The sketch herewith depicts how, with a few pieces of horn fiber rod carrying the net of twin wires, with a lamp inside it, one of these useful devices can be made. A tin pan can be fastened to the bottom of the fiber strips in which to catch the dead insects. The top support can be of wax-impregnated wood or of fiber. Slots

should be cut $\frac{1}{8}$ inch apart in the strips to accommodate the two bare wires. No connection exists between the wires until the insect "crosses" them.

Our second illustration shows a similar style electrical insect trap or annihilator, and in this case the fiber or other strips supporting the two parallel, oppositely charged electrical conductors, are tapered as shown. At the base of these fiber uprights supporting the two charged wires is suitably secured a small cup, in which honey or some other insect delicacy may be placed. An electric bulb, as usual in this class of apparatus, is placed inside the wire cage as in the previous design described above. A single switch may control both the light and the grid wires, as becomes evident.

MECHANICAL WAVES MADE VISIBLE ELECTRICALLY.

The following is a description of a novel and very interesting experiment, which is very easily performed, showing the stationary mechanical waves on a heated electric wire. Resistance wire is used to render it luminous, therefore the room should be darkened to obtain the best effects. I have tried two sizes of "Nichrome" wire; No. 19 gauge, of which about 12 feet was used, and about 6 feet of No. 24. The exact length for 110 volts may be determined by the experimenter; or, better still, a variable impedance coil may be used, in which event, the length of wire need not

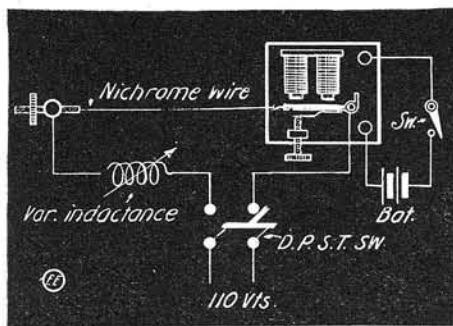

Making Mechanical Waves on Wire Visible.

be so exact. At any rate, the wire must be between a dull red and a white heat.

To produce the motion of the wire a buzzer is used to set up mechanical waves. Not having a buzzer on hand I used a bell with the clapper rod cut off as short as possible and the end bent to form a hook. The resistance wire is fastened to the hook, where one side of the 110-volt circuit is connected. The wire is stretched out to the desired length, where the other side of the circuit is connected; the impedance coil being in series with it, as diagram shows.

The switch for the buzzer circuit should now be closed and the room darkened. By means of the adjustable impedance coil regulator switch the wire should be raised to the desired temperature and tightened up again, as it expands when heated.

By varying the tension of the wire the waves may be observed. When the correct tension is obtained it should be kept constant. The loops or anti-nodes, and nodes of motion, can be easily seen. The loop is the maximum of motion, which is easily observed, as it cools quicker and will be at a "red heat" when the node is "white."

During the course of one experiment the wire broke. In my haste to repair it I made a loose joint. The resistance of the joint being high, it became luminous, while the rest of the wire remained invisible. The fantastic shapes and figures emanating from the juncture produced a very beauti-

ful and spectacular effect in the darkened room.

Contributed by R. E. RYBERG.

A "SAFE" BURGLAR ALARM.

Its mechanism is so simple and accurate that it can be thoroughly relied upon. The only thing necessary is to chisel out neatly one of your floor boards near your safe or valuables, about 2 inches in length. To make the device, bore a hole in a block of wood big enough so as to admit rod "R" as shown. On the top end fasten a hard rub-

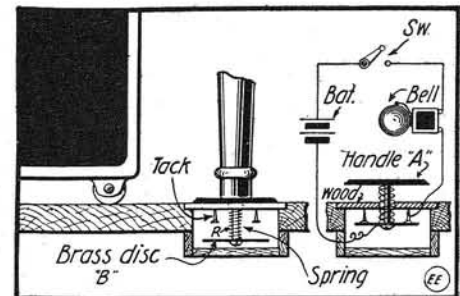

Removing Chair From Spring Switch Gives Alarm.

ber disc "A." At the bottom end a disc of spring brass. Fasten two common tacks and make necessary connections. Explanation: Place a chair on the side of your safe as shown in figure so that one of the legs rests on the top of "R." You have now set the alarm. As soon as the intruder comes to the safe he removes the innocent looking chair, which naturally is in his way, and the pressure of the spring in the device consequently pushes up the shaft, whereupon the brass disc "B" is connected with the bell and closes the circuit. But the initiated can remove the chair as he pleases, provided the switch is off.

Contributed by

JAMES BERK.

TO RENEW DRY CELLS.

Dry cells, if not too far spent, can be renewed by drilling (not punching) a hole (A) between the binding posts (B-B) and pouring chemically pure ammonia into it. The hole is then sealed up with wax and as efficient service as when it was new can be obtained from the renovated

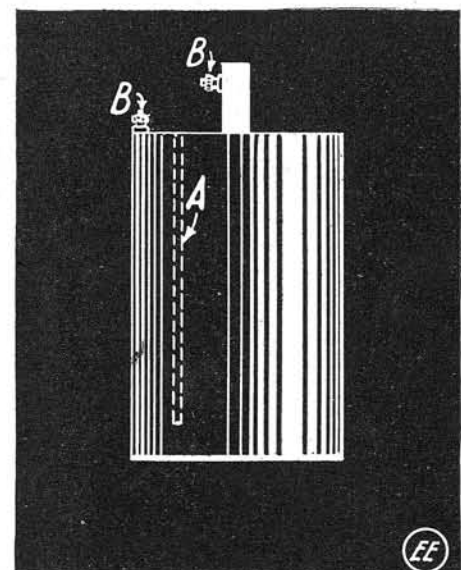

Method of Revitalizing Dry Cells.

battery. The ammonia will cost little if bought in jars at a time and preserved for future use.

Contributed by

A. BEL JEA.

Wrinkles Recipes Formulas

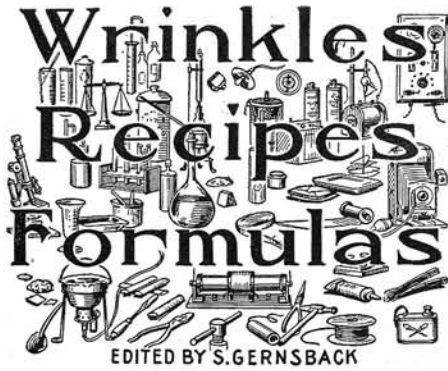

EDITED BY S. GERNSBACK

Under this heading we will publish every month useful information in Mechanics, Electricity and Chemistry. We shall be pleased, of course, to have our readers send us any recipes, formulas, wrinkles, new ideas, etc., useful to the experimenter, which will be duly paid for, upon publication, if acceptable.

FORMULA 15.

Blackings for Boots and Shoes.

1. *French Paste for Patent Leather.*—Take 6 drm. of *Pure Wax*, 2 oz. of *Olive Oil*. The wax has to be melted in a water bath. Mix thoroughly by stirring; heat moderately. Add $\frac{1}{2}$ oz. of *Oil of Turpentine* and $\frac{1}{2}$ oz. of *Oil of Lavender*. The mixture will form a paste, which should be put in boxes before it becomes cool. Apply with a linen rag. A very good paste, which keeps the leather soft and restores the gloss.

2. *Dressing for Tan Shoes.*—Take 1 oz. of *Annatto*, 1 oz. of *Gamboge*, 1 oz. of *Acacia*, 2 oz. of *Catechu*, 2 oz. of *Hydrochloric Acid*. Add water enough to make 40 ounces.

3. *Polish for Tan and Russet Shoes.*—1 oz. of *Dark Yellow Wax*, 3 oz. of *Oil of Turpentine*, 1 oz. of *Palm Oil*, 15 min. of *Oil of Mirban*. Melt the wax and oil together, add the turpentine, and, when nearly cool, the oil of Mirban.

4. *French Boot Blacking.*—Dissolve 150 parts of *Wax* and 15 parts of *Tallow* in a mixture of 200 parts of *Linseed Oil*, 20 parts of *Litharge*, 100 parts of *Molasses* at a temperature of 250° F. After this add 103 parts of *Lampblack*. When cool dilute the mixture with 280 parts of *Spirits of Turpentine*, and finally mix with a solution of 5 parts of *Gum Lac* and 2 parts of *Aniline Violet* in 35 parts of *Alcohol*.

5. *German Boot Blacking.*—Melt together 90 parts of *Ceresine* (or *Beeswax*), 30 parts of *Oil of Spermaceiti*, 350 parts of *Spirits of Turpentine*, with 20 parts of *Asphalt Varnish*. Add 10 parts of *Borax*, 20 parts of *Lampblack*, 10 parts of *Prussian Blue*, 5 parts of *Nitro-Benzol*.

6. *Self-Shining Blacking.*—Dissolve 8 oz. of *Gum Arabic* in 8 oz. of best *Black Ink*; add 2 oz. of *Olive Oil*. Mix thoroughly and then add 4 oz. of *Strong Vinegar*, 3 oz. of *Brown Sugar*, 2 oz. of *Alcohol*.

7. *Waterproof Blacking.*—Melt together 3 oz. of *Beeswax* and 3 oz. of *Black Resin*; then stir in 1 pt. of *Boiled Oil*. When it has cooled a little add 3 oz. of *Oil of Turpentine*.

8. *Russian Waterproof Boot Blacking.*—Melt 1 oz. of *Beeswax*, $\frac{1}{2}$ oz. of *Suet*, 2 oz. of *Olive Oil*. Add $\frac{1}{2}$ oz. of *Lampblack* and stir till cool. Warm the boots and apply the blacking.

9. *Liquid Shoe Blacking.*—5 oz. of *Animal Charcoal*, 4 oz. of *Molasses*, $\frac{3}{4}$ oz. *Sweet Oil*. Triturate until the oil is thoroughly incorporated, then stir in $\frac{1}{4}$ pint of *Vinegar* and $\frac{1}{4}$ pint of *Beer Lees*.

10. *Finishing Blacking.*—Mix together $\frac{1}{2}$ oz. of *Gelatine*, $\frac{1}{2}$ oz. of *Indigo*, 1 oz. of *Logwood Extract*, 2 oz. of *Crown Soap*, 8 oz. of *Softened Glue*, 1 qt. of *Vinegar*.

A GOOD SILVER-PLATING SOLUTION.

This solution will be found of excellent use in silver-plating different parts of electrical apparatus, jewelry, etc. Copper, Brass and German silver articles only can be plated.

Cut a silver quarter into small pieces and place in a porcelain or glass dish. Place the dish, uncovered, in a pan of warm water and add $\frac{1}{2}$ ounce of nitric acid to the metal. Let dish stand in the water until metal is all dissolved. Now add $\frac{1}{2}$ gill of water and one teaspoonful of fine salt. Let the precipitate settle and filter. Add more salt to the filtrate, and if any more precipitate falls filter again. Wash the precipitate on the filter paper until the water shows no acid when tested with filter paper. Add one pint of water to the precipitate and four scruples of potassium cyanide. Great care must be used in handling the cyanide, or the solution after it is added, as it is a deadly and almost instantaneous poison. Put a piece of zinc about 2x1x $\frac{1}{8}$ inches in the solution and it is ready for use.

No electric battery is needed. Simply clean the articles to be plated in a hot potash solution and rinse good in boiling water. Immerse in the solution for about $\frac{1}{2}$ minute, allowing the article to rest on the zinc. Wipe dry with a cloth and repeat. Heavier coatings can be given by repeating. Articles will take a high polish and wear fine.

Contributed by E. E. ZANDER.

A HANDY SPIRIT LAMP.

All that is needed to make this useful

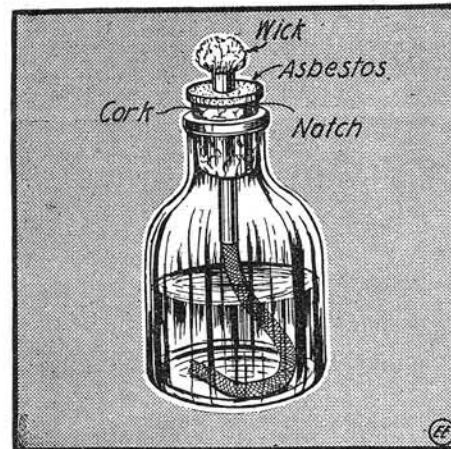

Useful Alcohol Torch.

little spirit lamp are: An old ink or muci-lage bottle, a wooden cork, a small tube, a piece of asbestos and an old lamp wick.

The cork should be made of hard wood and as seen in the diagram should have a hole bored through its center. Through this a piece of metal tubing about 1 $\frac{1}{2}$ inches long is inserted. There should be a notch cut in the side of the cork to admit air.

A piece of asbestos should be procured (a piece of an old asbestos shingle will do) about one inch in diameter with a hole bored through the center to admit the tube. The wick, which may be flat, should be run up through the tube to the desired height. Wood alcohol should be used as fuel as it gives intense heat and little smoke.

Contributed by HARRY RIDINGER.

Heat the whole over a slow fire and stir till thoroughly mixed. Apply with a soft brush and polish with a woolen cloth.

S. G.

CONVERSION OF RECIPE FORMULAS.

Sometimes amateurs see a formula or recipe which they might want to use, but cannot do so because the ingredients are expressed in "parts." A part in the sense of the word might mean anything. If specified in solids, it might mean anywhere from a grain to a ton; or if in liquids, might mean anywhere from a drop to a barrel; but if one should keep to the unit and use multiples it would be impossible to make a mistake.

For example, if the formula should say: Use 1 part of nitric acid, 2 parts of potassium bichromate (saturated solution), 5 parts of water (apologies to S. G. in *Electrical Experimenter*, April, 1915, under "Wrinkles, Recipes and Formulas," No. 3); all that is necessary would be to designate the exact quantity that the part represents; then, if one grain for solids and one minim for liquids should be used, the above formula would work out as follows: Nitric acid, 1 minim; potassium bichromate, 2 grains, and water, 5 minims. Of course, this can be multiplied to any proportion.

For further reference the following table will also be found very useful:

No. of parts.	Grains.	Minims.	*Grams, or c.c.
1	1	1	1
2	2	2	2
3	3	3	3
4	4	4	4
5	5	5	5
10	10	10	10
20	1 scr.	20	20
50	50	50	50
60	1 dr.	1 dr.	60
100	1 dr. 2 scr.	1 dr. 40 min.	100
250	$\frac{1}{2}$ oz. 32 grs.	1 dr. 40 min.	250
500	1 oz. 62 grs.	$\frac{1}{2}$ oz. 10 min.	500
1,000	2 $\frac{1}{4}$ oz. 16 grs.	2 oz. 40 min.	1,000
2,500	5 $\frac{1}{2}$ oz. 94 grs.	5 oz. 1 dr. 40 min.	2,500
5,000	11 $\frac{1}{4}$ oz. 79 grs.	10 oz. 3 dr. 20 min.	5,000
10,000	1 lb. 6 $\frac{3}{4}$ oz. 49 grs.	20 oz. 6 dr. 40 min.	10,000

*Metric system: Figures for grammes and cubic centimeters are the same.

It would be advisable for experimenters to copy the above table and put it in a convenient place in the laboratory, as it will be found very helpful for the rapid calculation of parts into liquids or solids, as the case might be. Contributed by

A. WILSDON.

CANNED HEAT.

Canned heat, a new discovery, is nothing else but solidified alcohol. The alcohol is suspended in a soap mixture so that it may be used for heating purposes and still not be open to the dangers from alcohol when burned alone.

Solidified alcohol may be made according to the following formula: Stearic acid, 8 $\frac{1}{2}$ grammes; caustic soda, 1-35/100 grammes; alcohol (grain or denatured), sufficient quantity to make 100 grammes.

Dissolve the stearic acid in about 50 grammes of alcohol by the aid of heat. Dissolve the caustic soda in about 40 grammes of alcohol. Mix and warm until the two solutions combine. Pour into suitable moulds. The moulds ordinarily used are friction-top tin cans capable of holding three or four fluid ounces. To ignite, the cover is removed and a lighted match held over the solid mixture. To extinguish, the cover is slipped on the can. Care should be taken not to tip over a lighted can, as when the mixture is burning it becomes a semi-liquid and, therefore, a source of danger if spilled. When the fire is extinguished and the mass allowed to cool the contents of the can again solidifies. The soap itself does not burn but is left in the can after the spirit has been consumed. Contributed by

ROBT. H. GYSEL.

WITH THE AMATEURS

Our Amateur Radio Station Contest is open to all readers, whether subscribers or not. The photos are judged for best arrangement and efficiency of the apparatus. To increase the interest of this department we make it a rule not to publish photos of stations unaccompanied by that of the owner. Dark photos preferred to light toned ones. We pay each month \$3.00 prize for the best photo. Make your description brief. Address the Editor.

AMATEUR RADIO STATION CONTEST.

Monthly Prize, \$3.00.
This month's prize winner.

RADIO NIAGARA STATION.

The accompanying photographs show the radio Niagara station and serve to clearly show the exterior appearance of the apparatus, so that only a brief description of details need be given.

The complete receiving equipment is home-made, having been built by myself. In the rear of the audion cabinet is a 1 to 1 ratio transformer for the amplifier. In place of the flashlight cells, which are so commonly used with the audion, I use ordinary dry cells which have been discarded from automobiles. There are two

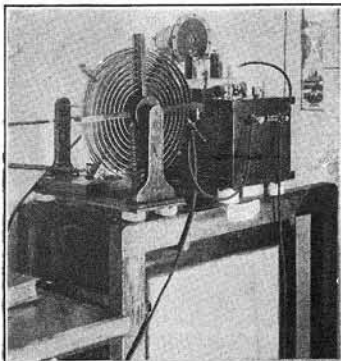

Left: Excellent and Well-Arranged Radio Transmitting Set of Orrin E. Dunlap, Jr.

Below: Master Dunlap and His Home-Made Audion Receiving Set. Note Marble Switch-Board at Right.

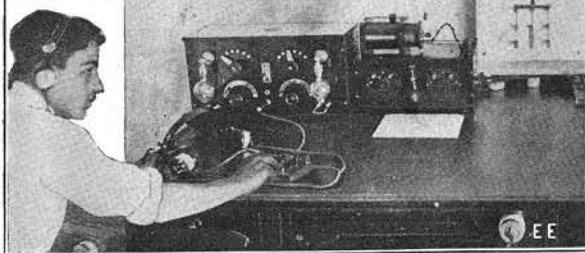

sets; 44 cells in a set. The tuning apparatus is mounted on a separate mahogany cabinet and can be used as a portable set if necessary. With this set I have heard Colon, Key West and many other distant stations.

The transmitter consists of a 1/4-K. W. Blitzen transformer, rack type condenser, made up of 10 double flint glass plates. Only four plates are employed on 1/4 K. W. The oscillation transformer is the AMCO type. The rotary gap is of the Clapp Eastham type.

I worked I. Z. L. of Northampton, Mass., regularly throughout the winter. The signals have also been heard in Vine-land, N. J., Waynesfield, O., and at Ann Arbor, Mich.

The aerial consists of six wires, 85 feet long, 70 feet high.

ORRIN E. DUNLAP, JR.
Niagara Falls, N. Y.

MR. GITTELBAUER'S RADIO SET.

My radio transmitting set comprises: A 1/2 K. W. transformer, 2 units each 1/4 K. W., plate glass condenser, fixed gap, oscilla-

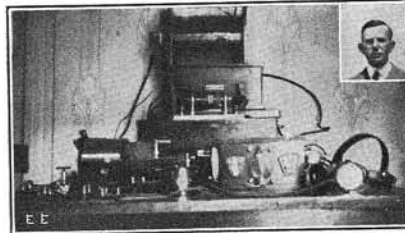

Mr. Gittelbauer and His Neat Radio Set.

tion transformer, "Boston" type sending key, aerial change-over switch, pilot lamp and a protective device across the 110-volt line to provide against kick-backs.

The receiving set includes: Loose-coupled tuner, aerial loading inductance, Audion detector, galena and silicon detector, also a "Crystaloi" detector with a cohering inductance.

Normal sending range 40 miles. Normal receiving range 500 miles, but can copy high power stations 1,200 miles.

The aerial consists of three wires (stranded copper) 70 feet long, stretched between two poles 52 feet high at one end, 46 feet high at other end. Ground: Three pipes, each driven 10 feet into moist earth. Aerial when not in use is grounded through a standard 100-ampere knife switch.

I hold a first grade commercial license, in addition to amateur license, and am a member of the American Radio Relay League. My official call is "2 A. Y."

FREDK. GITTELBAUER.
East Rutherford, N. J.

AMATEUR OUTFIT OF BERT ROUTLEDGE.

I give you herewith a photo and descrip-



Radio Station of Bert Routledge.

tion of my wireless station. Some of the apparatus is of commercial make, while the

others are home-made. The transmitting apparatus comprises the following: One-inch spark coil, rotary and open spark gaps, two Leyden jars, helix, key and necessary switches.

For receiving, I use successfully a loose coupler, two loading coils, variometer, two variable condensers, one fixed condenser, silicon and galena detectors, 2,000-ohm head-sets and buzzer to test out detectors.

My aerial consists of four wires, each 95 feet long, spread 2 feet apart. It is 55 feet high at one end and 45 feet high at the other. I also have a smaller aerial for sending. The war has effected the temporary closing of my station.

BERT ROUTLEDGE.

Sydney, C. B., Canada.

ROY C. BURR'S RADIO STATION.

The following is a description of my amateur station:

My aerial is made up of 7-strand No. 22

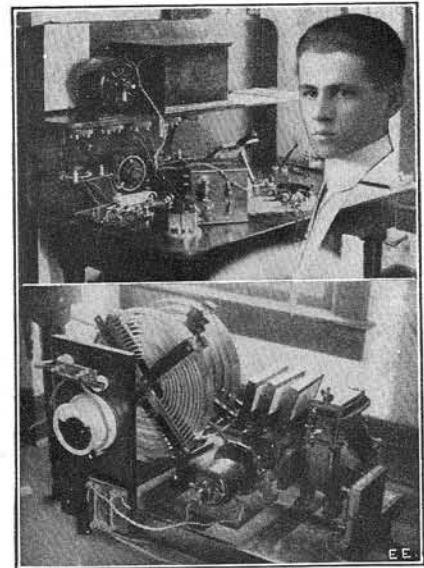

Excellent Radio Equipment of Roy C. Burr.

copper cable, 65 feet long and 50 feet high, located on a hill. For ground I use a large copper plate buried 10 feet in wet clay, also gas and water pipes. For sending I use 888 watt Thordarson transformer, 6 Murdock condenser sections, Blitzen rotary, oscillation transformer, Precision H. W. meter and 2 resistance rod kick-back preventers. All connections are of heavy copper bar and transmitter is mounted on plate glass base. 1 K. W. glass plate condenser and rotary quenched gap of my own construction are also included in this set.

My receiving set constitutes the following; 2 .01 M. F. variables, type D Clapp-Eastham tuner, R. J. 5 audion and galena detectors. Switch is provided for changing from audion to galena or vice versa. Five Blitzen duplex loose coupled loaders increase the tuning range considerably.

With the above set I have listened to a number of stations very clearly, including

such stations as 2 J.D. (New York City), 8 Q.J. (Detroit, Mich.), 9 B.D. (Superior, Wis.), 9 X.N., and many others.

This is a star station for the American Radio Relay League, and also a member of the Central Radio Association. Any experimenter who would like to communicate with this station is cordially invited to do so, my call being 8 R.D.
Norwalk, O. ROY C. BURR.

WIRELESS EQUIPMENT OF HAROLD C. SNOW.

Herewith I tender photos of my station and myself for entrance in your Amateur Station Contest.

The aerial utilized is of the "L" type, 90 feet long and 50 feet high, composed of 8 copper wires 2 feet apart. The receiving set comprises a Murdock loose coupler, rotary variable condenser, Perikon and Silicon detectors, 2,000-ohm head-set, and loading coil for long waves. With this set I am able to hear N.A.A. (Arlington) at all times of the day, and have frequently received signals from N.A.X. (Colon, Panama), N.A.R. (Key West, Fla.), N.A.W. (San Juan, P. R.) and N.A.W. (Guantanamo, Cuba), as well as many other Government and commercial stations.

The transmitting set is composed of a Blitzen type 1/4-k.w. capacity oscillation

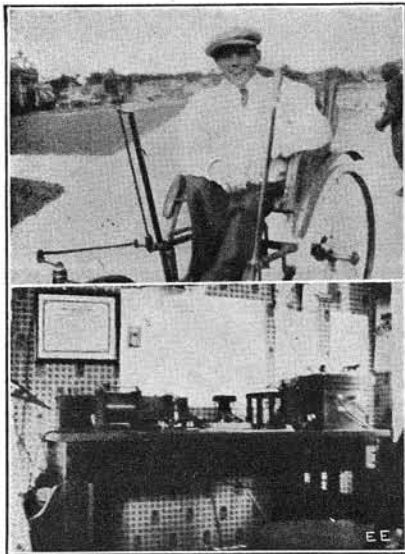

Harold Snow Finds His Radio Set of Great Interest.

transformer, glass plate condenser and sending key; a quick throw switch is used to change from receiving to sending.

I have a First Grade Amateur License and my call is 4 G.A. I shall be very pleased to hear from any other wireless operators.

HAROLD C. SNOW.

Swampscott, Mass.

W. O. HORNER'S TRIPLE VALVE STATION.

The photo herewith shown depicts my new transmitting and receiving station. My station comprises a 1-k.w. Clapp-Eastham transformer, condenser, rotary spark gap, improved oscillation transformer, hot wire ammeter, kick-back preventer and Blitzen wave-meter.

With this set I have heard Arlington time signals during the day 15 feet from the 'phones, and the 10 P. M. night signals as far as 90 feet during cold weather.

The triple valve audion receiver case is solid mahogany. I have been experimenting with the 1st or tuning audion, and find by placing a permanent magnet around the bulb on a line with grid and wing and by

delivering the proper or exact amount of current to the filament, the bulb will suddenly begin to oscillate, and I can then pick

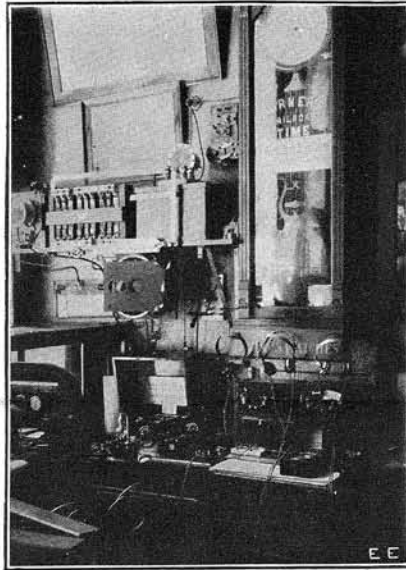

Efficient Radio Station of W. O. Horner, on Which Time Signals Are Audible 90 Feet from 'Phones.

up several undamped wave stations on the Atlantic and Pacific coasts.

W. O. HORNER.

Cleveland, Tenn.

STANLEY CARROLL'S EFFICIENT RADIO OUTFIT.

The following is a description of my wireless receiving station located at Marietta, O. My set comprises an "Electro" professional loose coupler. A Murdock variable condenser and its silicon detector, No. 322, with condenser inside it, with suitable capacity, and the "Electro" loading coil. My range at night includes Key West and Arlington. My aerial is of No. 14 wire, 112 ft. long, of four strands, with 7 1/2 ft. spreaders, 90 ft. high at one end, 65 ft. at the other. Aerial points westward. Am going to build a new aerial this fall just twice the size of my present one, and intend to get a 1/2 kilowatt sending set.

STANLEY W. CARROLL.

Marietta, Ohio.

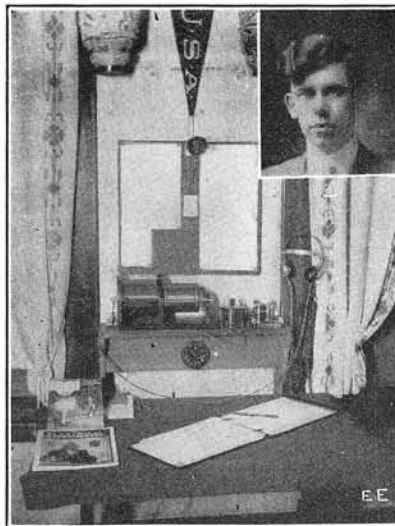

Stanley Carroll and His Wireless Set.

Do you realize that with his issue *The Electrical Experimenter* contains 72 pages?

WIRELESS STATION OF C. E. LAWSON.

Herewith is a picture of my wireless receiving set and aerial, which I hope to see published.

The receiving set comprises the following instruments: 2,500-meter loose coupler, 5,000-meter E. I. Co. loading coil, Junior fixed condenser, 2,000-ohm "Electro" amateur head set, "cat-whisker" galena detector, Murdock fixed condenser, Audion detector, pole-changing switch for throwing quickly from one detector to another, "Electro" baby switch for breaking crystal detector circuit when using Audion, and also marble-base lightning switch (not shown in illustration), in order to conform to underwriters' rules. Audion batteries are concealed in drawer of table. All woodwork is mahogany finish. On the right end of table will be seen my wire telegraph set.

The aerial consists of six strands of "Antenium" aerial wire, is 30 feet high at one end and 20 feet at the other end, 75 feet long and connected loop fashion, "L" type, in order to get the maximum wave length for receiving from high-power stations. My ground is No. 4 copper wire soldered to water pipe, and is about 15 feet long.

With the above set I can hear, any night in the year, the time signals from Arlington, Va., and Key West, Fla. I have also heard the Sayville, L. I., station at night, at

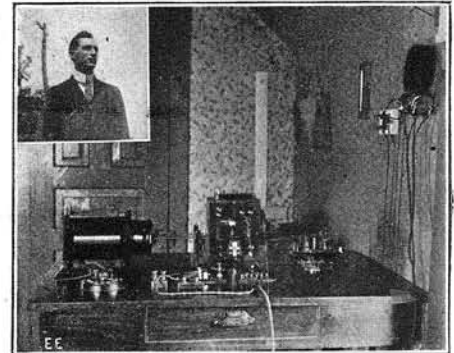

Particularly Neat Radio Station of C. E. Lawson.

favorable times of the year, and can hear the U. S. Naval stations at Charleston, S. C.; New Orleans, La.; Savannah, Ga., and Beaufort, N. C., as well as various near-by and smaller amateur stations.

This is, I consider, a very good record for so small an aerial, and I believe is due to the fact that all my connections are soldered and the wiring as simple and direct as possible.

I would like to exchange photos of my set with other amateurs.

CLARENCE E. LAWSON.

Cleveland, Tenn.

NEW RADIO CLUB IN BANGOR, ME.

The Penobscot Radio Club, of Bangor, Me., was organized recently and the following officers were elected: Harold Grant, president; Roy N. Johnson, vice-president; William J. Anderson, secretary and treasurer.

The other members are: William Hall, Cornelius Sullivan, Wainwright Reed and Edward Frey.

All the members have up-to-date apparatus. Meetings are held weekly at the home of the president. The club members would like to communicate with other radio clubs and exchange photos of amateur sets with other amateurs. Address all communications to William J. Anderson, 122 Lincoln street, Bangor, Me.

LATEST PATENTS

A. C. Massage Vibrator.
(No. 1,149,099; issued to Leo J. Wahl and Edward W. Wahl.)
The patentees of this device intend that it shall be used on alternating current circuits and in this

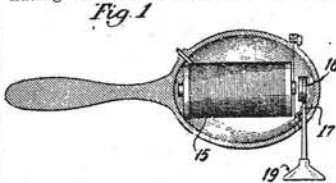

way a vibratory electro-magnetic force is caused to act from the electromagnet coil 15 on to an iron armature 16, which is attached to a pivoted, spring mounted, arm 17. On the end of the arm is a rubber applicator cup 19. The operation of the device is self-evident and it is very simple, magnetically considered.

Portable Electric Trouble Lamp.
(No. 1,148,662; issued to Oliver C. Dennis.)

This invention provides for a small electric trouble lamp, suitable for use about automobile engines, ma-

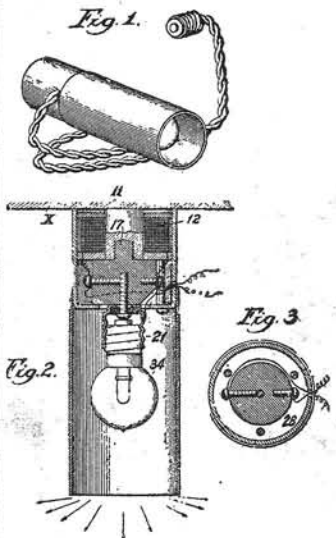

chine work, etc., and includes a strong magnet coil mounted in the base of same. This magnet coil 12, is connected in multiple with the electric lamp itself and is thus supplied with current from a common battery, such as that used for ignition on the car. The central core of the coil 12, is of iron, as is also the outside shell surrounding the coil. The magnetic flux passes out of the core 11, through the iron body, on which it may happen to rest at X, and so back into the second pole face, comprising the outer shell.

Electric Stethoscope.
(No. 1,147,282; issued to Kelley M.

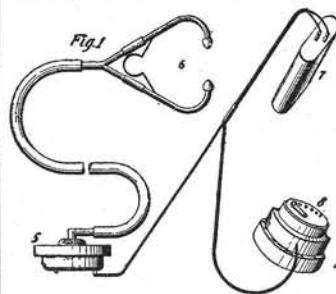

Turner, assignor to General Acoustic Co.)

An improved form of stethoscope, utilizing the well-known dictograph principle and therefore being of remarkable sensitivity. The specially arranged microphone and controlling rheostat 8 co-acts with a loud talking receiver 5 and the vibrations of its diaphragm are reproduced acoustically through the tube and ear pieces 6. A small battery, of the flashlight type 7, provides current for this system. The inventor claims that several parties can listen to the heart beats and also to the actual character of the beats simultaneously; owing to the greatly amplified strength of the beats, as reproduced by this dictograph apparatus. A much desired improvement it seems.

Electric Dry Battery.
(No. 1,147,753; issued to Leo J.

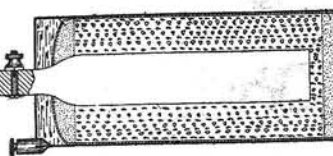

Schatzel, assignor of one-half to Oscar V. Maurer.)

A new style of dry battery cell made up in the usual manner, as illustration shows. Improvement consists in using as a depolarizer a persulphate of one of the following metals: Barium, strontium, ammonium, copper, manganese, calcium, sodium, lithium or potassium. Of these, however, potassium persulphate is the salt of persulphuric acid, which produces the most marked results. Such batteries yield 2 volts and the life of the battery, as well as its recuperative powers, is said to be well above that of any common cell heretofore manufactured. Complete formulae are given in the patent for making the entire cell.

New Wireless Head 'Phone.
(No. 1,148,941; issued to Harry B. Wier, assignor to Western Electric Co.)

Several good features are incorporated in this patent for an improved wireless head telephone receiver. Firstly, the receiver is adjustable to practically any position desired, by means of the swivel frame and trunnion 35 and 36.

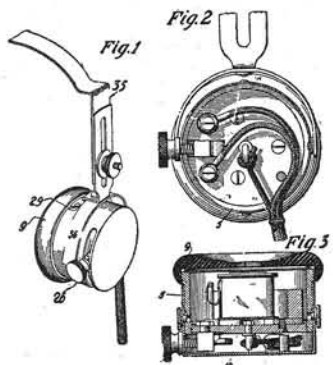

Secondly, the magnet poles may be adjusted to a greater or less distance from the diaphragm by means of a sliding thumb nut 26, attached to a threaded base plate 10, adjustably mounted inside the receiver shell. The nut 26 can be clamped at any position desired and the receiver is thus adjustable for different signals and frequencies. Further, the cap 9 and the inside shell 5 may be removed from the base shell by means of a bayonet joint 29.

Search-Light for Revolvers and Guns.
(No. 1,149,705; issued to Eugene S. Ward.)

A modified form of electric flash-



light with small size battery, which may be contained in the handle of a revolver, etc. The flashlight bulb is placed in a metal tube attachable to the under side of a revolver or gun. This tube has a sliding tube on same, so that the lens which it carries can be focused for the best results in any case.

Wireless Antenna.
(No. 1,147,010; issued to Reginald A. Fessenden, assignor by mesne assignments to Samuel M. Kintner and Halsey M. Barrett.)

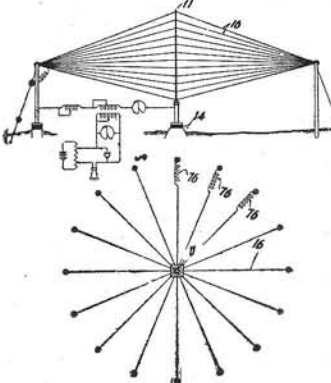

This patent covers in considerable detail the special form of umbrella antenna for radiotelegraphy, as used by Prof. R. A. Fessenden, at the Brant Rock station in Massachusetts. The illustration shows how the various guy wires 16, spaced radially about the 400-foot steel pipe mast 11, form a part of the aerial proper. The entire mast rests on an insulating glass base 14, and the patent covers methods for either using or not using the steel pipe mast as part of the aerial system. Also powerful spring shock or mechanical tension absorbers 76 are mentioned to be inserted in each guy wire, so that the mast will have great flexibility and resilience, mechanically considered. The guy wires are, of course, highly insulated, as becomes evident in view of the fact that they form a part of the antenna proper.

Loud Speaking Telephone Receiver.
(No. 1,152,536; issued to Albert S. Moffatt.)

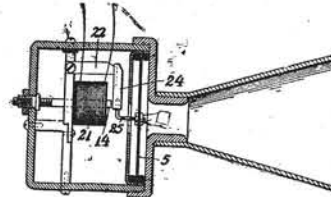

The patentee of this new loud-

talking telephone receiver arranges an electro-magnetic circuit in the shell of same, as perceived. The diaphragm 5 is resiliently mounted and is actuated so as to reproduce sounds by means of a lever 25, connected to the soft iron armature 24. The position of the fulcrum lever 22 may be adjusted, and it is thus seen that owing to the difference in leverage thus obtainable that it is possible to greatly amplify the movement of the armature 24. Thus it is possible to make a satisfactory electro-magnetic telephonic reproducer. Also the pole 14, of the electro-magnet 21, is adjustable as to its position, as will be observed.

Electric Pilot and Night Lamp.
(No. 1,147,949; issued to Eliot Keen.)

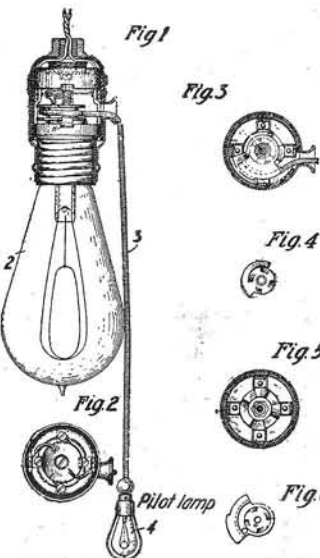

This patent covers a special form of pull socket in which the pull cord is arranged to comprise a flexible double conductor. To the end of this twin flexible pull cord is attached in a protective casing or cage a small pilot lamp 4. Either the large regular lamp 2, or the small pilot or night lamp 4, may be switched on by alternating pulls on the cord 3.

Electric Sad Iron.
(No. 1,148,627; issued to Edward E. Rose.)

New style of electric sad iron, providing a very neat and efficient

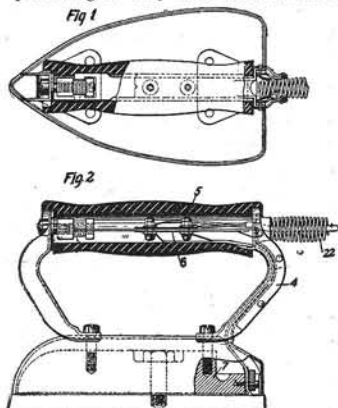

arrangement for leading in the double conductor cord. The double conductor cord passes through a protective spring 22, adjacent to the insulating handle 5. A connection block 6 is placed within the hollow handle and two lead wires run down through the hollow handle frame 4, to the heating element 7.

COPIES OF ANY OF THE ABOVE PATENTS SUPPLIED AT 10c. EACH.

Phoney Patents

Under this heading we will publish hereafter electrical or mechanical ideas which our clever inventors, for reasons best known to themselves, have as yet not patented. We furthermore announce the grand opening of the

PHONEY PATENT OFFIZZ

For the relief of all suffering daffy inventors in this country as well as the entire universe.

We will revolutionize the Patent business immediately and OFFER

YOU THREE DOLLARS (\$3.00) FOR THE BEST PATENT. If you take your Phoney Patent to Washington, they charge you \$20.00 for the initial fee and then you haven't a smell of the Patent yet. After they have allowed the Patent, you must pay another \$20.00 as a final fee. That's \$40.00!! WE PAY YOU \$3.00 and grant you a Phoney Patent in the bargain, so you save \$37.00!! When sending in your Phoney Patent application, be sure that it is as daffy as a lovesick bat. The daffier, the better. Simple sketches and a short description will help our staff of examiners to issue a Phoney Patent on your invention in a jiffy.

PHONEY PATENT OFFIZZ

U. R. WRIGHT OF WHEREATIN VA.

No. Umsteen hundred and forty 'leven.

BOOKWORM'S NURSE

Pat. applied for 10 minutes 'fore lunch.

Specification of Phoney Patent—Application Sandpapered September the Tooth

To those who—consarn it all, here goes:

I, U. R. Wright, of the Burg of Whereatin, Va., do hereby swear dreadfully, and affirm firmly that I have invented means whereby and by which a confirmed Bookworm may be relieved of all anxiety about reading too late at night, getting wet in the rain, getting overheated or run over by vehicles.

Full description of this wonderful apparatus follows:

A small but powerful dynamo is strapped to the small of the back. On each end of the shaft is an aluminum flywheel covered with fly-paper and having teeth around the inner edge of the rim. Pawls fastened to the legs of the wearer engage these teeth and spin the dynamo when the victim walks along either fro or to, hither or thither. The current thus generated is led by small wires to storage batteries concealed in the high stove-pipe hat which goes with the outfit. So a man, thus fitted out, really has "bats in his belfry." The top of this hat is the most ingenious part of the whole mechanism. It consists first of a shallow hard rubber pan, shaped much like a friction tight molasses bucket lid. In this lid are laid narrow strips alternately of copper and zinc, these being connected in parallel. On top of this is an image of Theodore Roosevelt, rampant, carved from a lump of copper sulphate or bluestone. More about this later.

Between the shoulders of the unfortunate is an umbrella which normally hangs down, closed, behind him. On the handle end of the umbrella is a segment of gears which engage with a small motor. Now the action is thus: When a shower starts, and the Bookworm is ambling along, face buried in a volume of "Deadwood Dick," the rain drops trickle over the Bluestone image of "Teddy," partly dissolving him and covering the zinc and copper strips with bluestone solution, thus forming an

electric cell. (The bluestone image, after months of constant use, will acquire a likeness to William Jennings Bryan.) The electric current thus set up actuates a switch which cuts in the storage battery

umbrella is automatically let down to its normal position.

Strapped to the chest (if he has one) of the victim is a small electric fan in circuit with a thermostat so when it is warm the thermostat starts up a delightful mountain breeze.

Reading so much a man is likely to forget to wind his watch, so an electric watch is provided. Injury to the eyes by reading in too dim a light is prevented by a selenium cell, which in dim light releases a switch operating an electro-magnet which pulls a lever to and fro rapidly, on the end of which is a pepper shaker. This shakes pepper in the eyes of the reader and thus calls a halt.

While crossing the street, interested in a book, one pays no attention to approaching autos and cars. A sensitive microphone worn on the person actuates a spark, which explodes a bomb under the coat tails of the bookworm, hefting him gently into the air, while the said vehicle saunters nonchalantly on beneath him upon its wonted way.

To prevent reading in bed too late at night, a 10-pound mallet is fastened in the umbrella socket, and at the appointed time the electric watch connects the circuit and the mallet descends upon the noodle of the victim, giving 40 swift swats, knocking him insensible till morning, when he is awakened by a shock of 10,000 volts from an induction coil.

In testimony whereof, I have hereunto appended my non-defeather this day, O Lord, preserve us from further attacks.

U. R. WRIGHT.

By his attorney,

STANLEY H. COVINGTON,
Lynchburg, Va.

Witnesses: I. B. Darn, Whooda Thoughtit, Ischga Bible.

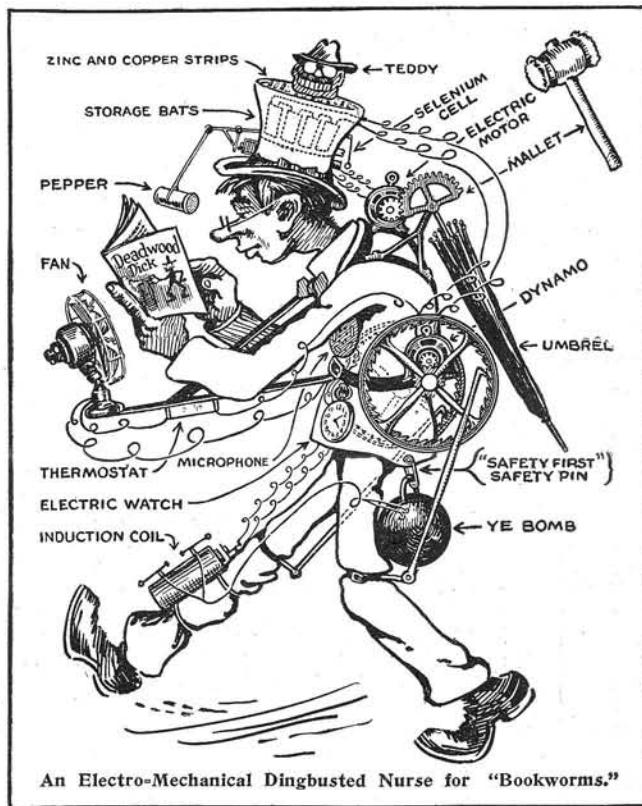

An Electro-Mechanical Dingbusted Nurse for "Bookworms."

to the motor which hoists the umbrella. There is a tiny hole in the bottom of the hard rubber lid or pan which contains the zinc and copper strips so that the bluestone solution trickles very slowly out, and down the back of the wearer's neck. For this reason the patient must wear blue acid proof overalls. When all of the solution has run out, the switch is released and the

tions caused by the machinery. The apparatus will work effectively, it is said, regardless of the number of ships within its operating radius. The other invention has not been made public.

NEW WIRELESS STATION AT CHELSEA, MASS.

On Sept. 15 the new wireless station at the Naval Hospital, Chelsea, was opened. It will be the most powerful on the Atlantic coast. The station at the navy yard will not be dispensed with, but will be run just the same. The new station cost in the vicinity of \$125,000.

WIRELESS SYSTEM SAVES 500,000 LIVES IN A YEAR.

Fresh evidence of the value of the wireless as a saver of lives has been found during the disasters and threats of disasters following in the wake of the European war.

Repeatedly the Atlantic Ocean has been combed by wireless in its sending of warnings to threatened passenger ships. Although no figures are at hand, a wireless operator has just estimated that not fewer than 500,000 lives that would have been lost before the invention of the Marconi system have been saved by it since the beginning of the present year.

INVENTION TO DETECT PRESENCE OF OTHER BOATS.

W. Lorenz, a jeweler of Buffalo, N. Y., has succeeded in perfecting two valuable instruments which have been accepted by the Canadian navy. One of the inventions is known as a "ship detector" on which he has been working two years.

The detector makes it possible for a ship properly equipped to ascertain whether other boats are within a certain distance, their direction and approximate location. The instrument works on the principle of wireless telegraphy. The vibrations of a ship being detected are communicated to the receiving apparatus through the vibra-

QUESTION BOX

This department is for the sole benefit of the electrical experimenter. Questions will be answered here for the benefit of all, but only matter of sufficient interest will be published. Rules under which questions will be answered:

1. Only three questions can be submitted to be answered.
2. Only one side of sheet to be written on; matter must be typewritten or else written in ink, no penciled matter considered.
3. Sketches, diagrams, etc., must be on separate sheets. Questions addressed to this department cannot be answered by mail.

MEASUREMENT OF FREQUENCY IN A. C. CIRCUITS.

(345) F. Callahan, _____, wants to know how the frequency of an alternating-current circuit may be measured.

A. 1. There are several ways of measuring the frequency in cycles of alternating-current circuits, but the usual and most direct method is that utilizing a standard "frequency meter" of the direct-indicating type. One of these, of the vibrating-reed type, costs about \$65 for frequency measurements somewhat above and below 60 cycles.

FREAK RADIO RECEPTOR.

(346) J. M. Butcher, Medina, O., explains how he has picked up radio signals on a telegraph sounder without any detector.

A. 1. In most cases that have come to our attention and along the line you mention it has been found that the armature bar, etc. (of the telegraph sounder, for instance), has been so adjusted that it formed a *microphonic* contact which would pick up wireless signals; or also it would act as a reproducer of speech under certain conditions.

Quite possibly the dead wire circuit running from the sounder acts as an aerial, and wireless signals have been repeatedly picked up by using a telegraph or telephone circuit as an antenna.

BATTERY CHARGING CUT-OUT.

(347) L. J. Roche, Lafayette, N. Y., inquires about making a battery charging

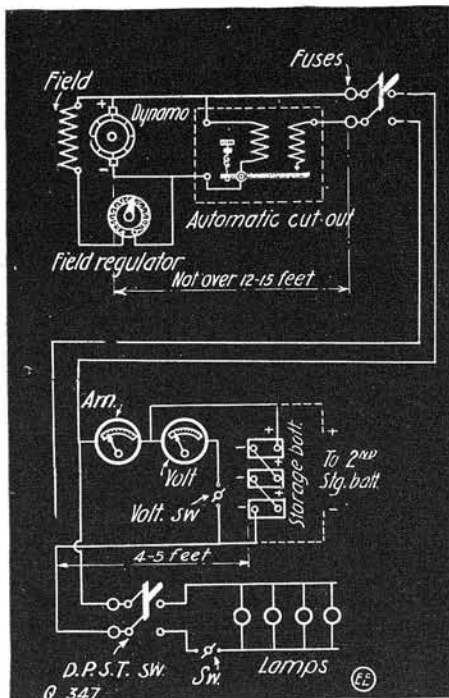

Wiring Diagram for Storage Battery Lighting Plants.

cut-out for accumulator plants.

A. 1. The appended lighting plant dia-

gram shows how the E. I. Co. automatic storage battery charging cut-out works.

You may experiment with this form of cut-out, and in designing the coil windings you should allow about 1,000 circular mils area of copper wire for each ampere which is to pass through the coils. Hence you can very easily design the coils by referring to a standard B. & S. wire gauge as given in most electrical catalogs.

While one size of cut-out with certain windings on same will take care of a dynamo and battery outfit somewhat higher or lower in voltage than that which it is

Tuckerton, N. J., uses a Poulsen arc oscillation generator of about 60 k.w. rating.

Data on this and other powerful stations in this country is given in the Government "Radio Call Book," procurable at 15 cents from the Superintendent of Documents, Washington, D. C.

LOADING COILS.

(349.) R. A. de Vore, Atlanta, Ga., wants to know the number of turns necessary on tuning coils 3 inches in diameter to obtain the longest possible wave length with an aerial 300 feet long and 50 feet high. He also wishes to know the maximum additional wave length he can receive by using a loading coil.

A. 1. There is, generally speaking, no limit to the wave length you can receive by using large coils; that is, you can wind a coil 10 feet long, but such large coils are not properly proportioned. A properly constructed tuner has a length that is equal to about four times its diameter. A coil of this size, 12 inches long and 3 inches in diameter, wound with No. 24 wire, in connection with your aerial should have a wave length of about 2,500 meters, and you can add loading inductance both in the aerial circuit and the detector circuit to raise this wave length up to 7,000 or even 10,000 meters by using coils large enough. The usual practise is to put a condenser across the secondary circuit to increase its wave length.

CONDENSERS AND RANGES.

(350.) A. Paul Peck, Plainfield, N. J., asks several questions: 1. Whether glass plates can be used in receiving condensers. 2. The wave length of his aerial. 3. The distance over which he can receive with his apparatus. 4. How far he can transmit with a buzzer outfit.

A. 1. Glass plates can be used for re-

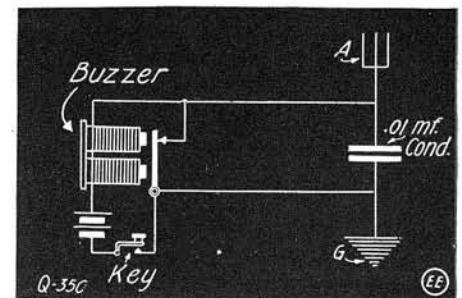

Buzzer Used for Transmitting Radio Signals.

ceiving condensers and are suitable for such purposes, but their disadvantage is that they are rather bulky; otherwise they are superior to those made from paraffine paper.

A. 2. The wave length of your aerial, 80 feet long, 20 feet high, with lead-in 15 feet long and a ground wire 20 feet long, would be approximately 160 meters.

A. 3. We do not make a practise of answering questions regarding the range over which wireless sets will receive, be-

(Continued on page 354.)

Want to Swap?

If you have anything to buy, sell or exchange and want to make sure of doing it quickly and at an insignificant cost, advertise in the

Scientific Exchange Columns

OF

The Electrical Experimenter

You will find advertised in these columns:

Photographic supplies, Phonographs, Wireless Apparatus, Electrical goods, Bicycles, Motorcycles, Rifles, Gasoline Engines, Microscopes, Books, Skates, Typewriters, Etc.

The owners of these things wish to "swap" them for something else, something which you may have.

The Rates

One cent per word (name and address to be counted) minimum space 3 lines. Average 7 words agate to the line. Remittance must accompany all orders.

The Classified Columns of the ELECTRICAL EXPERIMENTER GET RESULTS

More than 40,000 Electrical Experimenters will see your ad.

designed for, it becomes necessary to re-wind the coils especially for the dynamo to be used when the dynamo varies 20 to 25 per cent. above or below the rating of the cut-out.

THE TUCKERTON, N. J., RADIO STATION.

(348) James S. _____, Washington, D. C., asks what form of high-frequency generator is employed at the Tuckerton, N. J., trans-oceanic wireless station operated by the Goldschmidt interests.

A. 1. The powerful radio station at

EXPERIMENTERS READ EVERY LINE OF THIS INTERESTING AD-

We've prepared it with care and it's written for YOU. We want you to know the Electro-Set Co. We are anxious to have you realize what we are doing to make experimenting financially possible for every live American Boy. We haven't space to tell you all—you'll have to send for our catalogues to see this. We are taking this opportunity to introduce only seven of our regular specialties and 14 wonderful bargains in odd parts such as every experimenter needs and can use. One order will convince you what the Electro-Set Co. is offering. Get in touch with us today.

HERE IT IS AT LAST! This 1-6 K. W. Closed Core Wireless Transformer. \$6.95



After months of experimenting and after making dozens of designs and models, we have finally produced a thoroughly practical closed core transformer to retail at \$6.95, the price you formerly had to pay for spark coils and batteries.

Thousands of amateurs will welcome the advent of this instrument who either did not require $\frac{1}{2}$ K.W. power or who did not care to spend the money for it. The transformer will send messages for twenty miles not a wild figure, but an actual fact—if a good aerial is used. Under extraordinary circumstances it will send one hundred miles. No trouble with vibrators and adjustments, reactances or resistances. Just connect the primary terminals to 110 volt, 60 cycle A.C. mains as is used in its construction.

It will throw a heavy crashing spark that, with proper condenser, will fill a gap with a ball of white flame $\frac{1}{4}$ inch in diameter. This comparatively small but powerful spark will send six times as far as a 1 inch spark coil. The 1-6 K. W. Transformer is another ELECTRO-SET triumph. It was thoroughly tested in one of the most complete electrical laboratories in the country by competent engineers, who pronounced it perfect for its size, in all particulars. You will be delighted with it.

No. 1000 1-6 K. W. CLOSED CORE TRANSFORMER, without case, shipping weight 10 lbs. . . \$6.95
 No. 1001 1-6 K. W. CLOSED CORE TRANSFORMER, in a beautifully finished mahogany case; impregnated with insulating compound and fitted with four posts; shipping weight 15 lbs. . . 9.00

Electro-Set "Navy" Loose Coupler

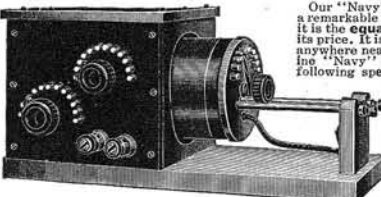

Our "Navy" Loose Coupler or Receiving Transformer is a remarkable instrument. In price it is lower and in quality it is the equal of almost any loose coupler, no matter what its price. It is certainly far superior to any we have seen at anywhere near its price. Think of being able to buy a genuine "Navy" type loose coupler at a low price with the following specifications usually only found in prohibitively priced transformers: Hard rubber secondary end with large turned brass contacts; hard rubber switch panel on the front of the primary coil with twenty large, turned brass contacts; primary enclosed in a dark mahogany finished covering on all sides; every contact soldered, assuring perfect connection; handsome mahogany finished base; lacquered brass posts and trimmings. The equal of this receiving transformer can not be found. It is the acme of efficiency at moderate price.

No. 1698 "NAVY" RECEIVING LOOSE COUPLER; shipping weight 10 lbs. \$10.00
 No. 1699 "NAVY" RECEIVING COUPLER; all wood construction. 9.00

Type "A"



This Rotary Spark Gap is without an equal. Made like any of the more expensive gaps, but smaller in size. It operates in series with a 16 C. P. lamp on 110 volt alternating or direct current or from batteries. The Rotary Electrode is of cast aluminum alloy and is perfectly accurate. The wheel is mounted with genuine hard rubber on a heavy brass bushing which fastens to the motor shaft. The motor is a K. & D. series wound A. C. or D. C. Machine, small but powerful. This Type "A" Gap, although especially designed for our extraordinary 1-6 K. W. Transformer will readily stand any good $\frac{1}{2}$ K. W. instrument.

No. 476 TYPE "A" ROTARY GAP, shipping weight 4 lbs. . . \$5.50
 No. 477 TYPE "A" ROTARY GAP, wound to operate on 3 dry cells. 5.00
 No. 478 THREE INCH ROTARY DISC ONLY, mounted on hard rubber, with brass bushing, $\frac{3}{8}$ in. hole, shipping weight 4 oz. 1.50

Send 4c Today For Our Big New Catalogue

containing description of dozens of new wireless and experimental instruments, parts and raw materials. Prices are new—instruments are new—catalogue every experimenter MUST HAVE.

Write Today Special Catalogues

Send 6c. in stamps for our SPECIAL ELECTRIC TRAIN CATALOGUE, illustrating scores of models. Send 4c. in stamps for our Electric Vibrator and Medical Coil Catalogue.

We Are Agents For MARCONI USED APPARATUS

Send 5c. in stamps for new, interesting catalogue of used Marconi Wireless Instruments at ridiculously low prices. We are agents for this line and can ship promptly anything from a Type "D" Tuner to a Motor Generator.

No. 611 Aerial Switch



This instrument is novel in design and convenient in operation. The base is dark mahogany finished. The copper bars are 8 inches long and are sawed, not drawn. Posts are provided on all contact jaws for connections. Three posts and bars are provided on one side for the purpose either of shunting the detectors when sending or cutting off the transmitting power when receiving.

This instrument is handsome in appearance and efficient in use. Suitable for powers up to 1 K.W.

No. 611 AERIAL SWITCH,
 Shipping weight 5 lbs. \$2.50.

Electro-Set "Arlington-Tested" Crystals

When testing out a wireless receiving installation for the first time you want to know that your mineral crystal is sensitive. Then, too, why buy minerals on a gamble. Be sure of results—good results. Buy our "Arlington Tested" Crystals. Every one is tested for Arlington time signals. Each crystal comes sealed in an air-tight glass phial and is carefully tested before leaving our factory. Only one crystal in 20 passes our examination. Arlington Tested Crystals are the most sensitive you can procure. They are worth the price. Each one is individually examined and packed.

No. 301 ARLINGTON TESTED GALENA, individually packed and tested; postpaid. . . \$0.15
 No. 302 ARLINGTON TESTED SILICON, as above. 15
 No. 303 ARLINGTON TESTED BORNITE-ZINCITE COUPLE. 40

polished wood detector base; one large binding post; one hard rubber knob; one brass rod with holder for wire. With this outfit it is possible to make many different kinds of detectors. It is ideal for the experimenter.

No. 2100 DETECTOR MINERAL SET, as described, complete, postage paid. . . \$1.25
 No. 2150 MINERALS ONLY, as above, five kinds, in bottles, postage paid. 50

Electro-Set "Famous" Mineral Sets

One of the most interesting fields in wireless telegraphy is the experimenting with various combinations and methods of contact in detectors. We offer the following outfit especially designed for this purpose and packed in a neat box. Countless hours of interesting experimenting is offered to the amateur with this set. It includes five different minerals (galena, silicon, carbundum, bornite and molybdenum), each packed in a neat glass bottle; one universal detector cup; three pieces phosphor-bronze "cat whisker" wire; one brass rod with holder for wire. With this outfit it is possible to make many different kinds of detectors. It is ideal for the experimenter.

No. 2100 DETECTOR MINERAL SET, as described, complete, postage paid. . . \$1.25
 No. 2150 MINERALS ONLY, as above, five kinds, in bottles, postage paid. 50

14 EXTRA-ORDINARY BARGAINS

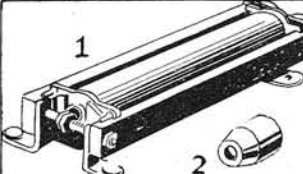

1

Polarized Ringers—New, never used. Complete with 2 high resistance magnet coils wound with silk wire and a strong permanent magnet with ringer. Worth 60c. ea. Any experimenter can use one. Special price, ea. 15c. (Postage 6c.)

Hard Rubber Knobs—Size 19-16 in. x $\frac{1}{8}$ in. Drilled and Tapped for 6-32 screw. Handy for making apparatus. Worth 3c. ea., new. Special Price, per doz. 10c. (Postage 3c.)

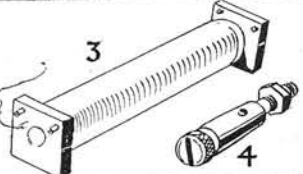

3

Telephone Induction Coils—Never used. Wound to 100 Ohms with primary and secondary coils, silk covered wire. Excellent shocking coil can be made with one. Worth 50c. ea. Special price ea. 09c. (Postage 4c.)

Binding Posts—Handsomely nickelled, 5-16 in. x 1 in., over all. Complete with nut. Worth 6c. ea. Special price, per doz. 25c. ea. 2 $\frac{1}{2}$ ¢. (Postage per doz. 5c.)

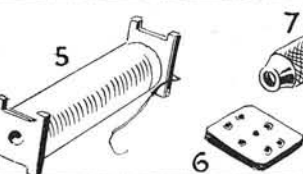

5

Telephone Relay Coils—Wound to 100 Ohms with size 36 silk covered wire. Complete with soft iron core. Wire alone worth 20c. Special price, ea. 09c. (Postage 4c.)

Connecting Blocks—Hard rubber, size $\frac{1}{4}$ in. x 1 in. x $\frac{3}{16}$ in. Have 6 holes for 6-32 mach. screws. Complete with 6 screws. Worth 12c. ea. Special price 04c. (Postage 1c.)

Hard Rubber Handles— $\frac{1}{4}$ in. x $\frac{1}{2}$ in. Drilled and

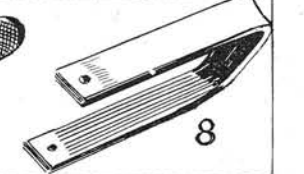

7

Horseshoe Magnet—3 in. long, very powerful—useful for many experiments and for making instruments. Worth 15c. each. Special price 05c. (Postage 3c.)

Here's A Handy Chance—We have made up a number of boxes of small odd parts of electrical apparatus that every experimenter can use in his

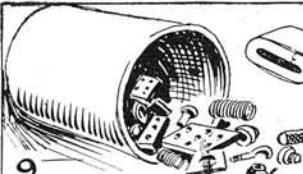

9

shop. These boxes each contain from 40 to 60 pieces of odds and ends, such as rubber knobs, brass standards, hooks, binding posts, screws, nuts, thumb nuts, coils and miscellaneous parts. Some are new—some used, but all of them are useful to have around when you are making apparatus. They are just the kind of convenient parts to be able to choose from for your experiments. We've sold hundreds of them in our retail department. Experimenters all want them. You can make dozens of them with them.

No. 121—Handy Assortment. Prepaid 20c.

75 Ohm Receiver Coils—Never used. Ready to put into any phone or to make receivers with. Wound to 75 ohms with silk wire. Worth 20c. pair. Special price, per pair, with connectors 06c. (Postage 1c.)

Connecting Blocks—Made of genuine hard rubber, with 4 nuts and screws with connectors. Worth 15c. ea. Special price, ea. 05c. (Postage 2c.)

Connecting Blocks—made of genuine hard rubber with 3 handsome nickelled binding posts. Useful for dozens of things about the experimenter's shop. Worth 20c. They have never been used. Special price, ea. 09c. (Postage 2c.)

Relay or Telegraph Magnets—In fair condition. Have been used but are in perfect shape. Wound to 80 ohms resistance. Make relay or telegraph with them. Worth 50c. pair. Special price with yoke, per pair 09c. (Postage 6c.)

Toy Motor Parts—Consisting of one iron case with pole pieces; 2 covers for same and 2 laminated armature with shaft. All you need is a commutator, bearings, and wire to complete motor. Above parts worth 40c. set. Special price, 15c. (Postage 6c.)

Note—Commutator wire for above motor, extra 40c. (Prepaid.)

THE ELECTRO-SET CO. 1874 EAST 6th ST., Dept. 110 CLEVELAND, OHIO

You benefit by mentioning "The Electrical Experimenter" when writing to advertisers.

YOUR RANGE DEPENDS ON YOUR RECEIVERS



**Holtzer-Cabot
Radio Receivers**
have honestly
earned their
reputation of
being the

"Most Sensitive Receivers Made"

Other features are light weight, comfortable shape, durability, perfect finish. Send for Booklet 20 D2 for description.

THE HOLTZER-CABOT ELECTRIC CO.
BOSTON — CHICAGO

LOOK! A NEW CHAMBERS COUPLER No. 744, PRICE ONLY \$6.00

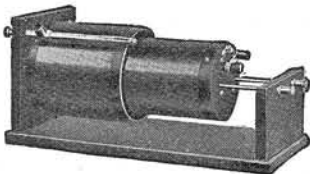

Positively unequalled for the money. Is 6" high, 6" wide, and 14" over all. Wound with Enameled wire, and has a very unique slider. Wood-work mahogany.

any finished. Try one, you will not be disappointed. 5c. in stamps brings our 64-page illustrated catalogue, B-B-24. None otherwise.

F. B. Chambers & Co. 2046 Arch Street Philadelphia, Pa.

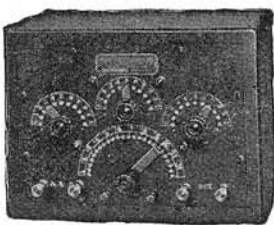

"Mignon-System"
Patents Applied for

**RC 2
\$20.00**

A Marvel in Selectivity and Efficiency.

The Last Word in RADIO APPARATUS.

Write for Literature

MIGNON-WIRELESS CORPORATION
Specialists in Radio Signal Receiving Apparatus
127 W. Market St., ELMIRA, N. Y.

NEW SAYVILLE PHOTO

SHOWING THE ELEVEN NEWLY COMPLETED MASTS (3 of them 500 feet high). Also two detail inserts, showing buildings, etc.—3 in 1—Size 6x8 in. Mailed in roll, ready for mounting 25c. postpaid. Send stamps. Ask for free wireless catalog.

CHRIS. M. BOWMAN
Box 104 LANCASTER, PA.

cause there are so many factors governing this. It is impossible to make more than a haphazard guess.

A. 4. The buzzer transmitter set illustrated will transmit about half a mile under ordinary conditions, but distances as high as five miles have been covered with same. A prominent New York firm is about to market a buzzer which they claim will cover distances of about 100 miles.

AERIAL AND GROUND.

(351.) Wallace Green, Hackensack, N. J., asks: 1. The effect of the height of an aerial above sea level. 2. The effect of grounding wireless apparatus and a telephone on the same water pipe.

A. 1. The height of an aerial above sea level will have a tendency to increase your range, but not in direct proportion, as it is the height above the ground which determines to a great extent the range. This is due to the fact that waves propagated into the ether have a tendency to follow the surface of the ground and not to continue in the same plane as the station from which they are emitted.

A. 2. The effect of grounding wireless apparatus and the telephone on the same water pipe will not be noticed unless the phone wires run very close to the aerial. In that case a large part of the energy from the transmitting set will be absorbed by the wires and will cause annoying noises in the receiver when using the phone.

RADIO QUERIES.

(352.) W. B. Jones, Hampton, Va., asks: 1. For a hook-up for a transmitting apparatus and receiving apparatus. 2. If he

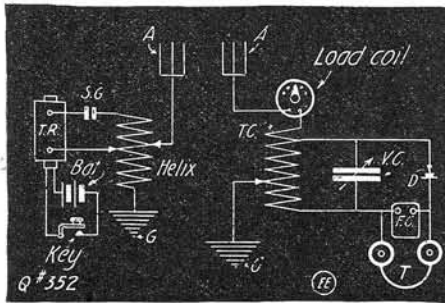

Radio Transmitting and Receiving Hook-ups.

can pick up Sayville and other such stations. 3. The standing of the Dodge Institute of Telegraphy and Radio.

A. 1. Attached drawing shows the method of wiring transmitting outfit, using quenched gap, 3/4-inch spark coil. Hook-up for your receiving outfit is also shown.

A. 2. We cannot say positively if you can receive Sayville or not, but would advise you to listen for signals when the station sends press, which is between 8 and 11 p. m.

A. 3. We are assured that the Dodge Institute of Telegraphy has the best that can be obtained in equipment, and its faculty consists of experts in the line they are teaching.

A. C. MOTORS.

(353.) Earl Meldrim, Fort Edwards, N. Y., inquires the difference between one, two and three-phase motors, and which are the best to use.

A. 1. One-phase motors operate on an alternating current circuit that possesses but one wave; that is, it reverses at stated periods. The two-phase circuits generally consist of four wires, and the phases are 180 degrees apart; that is, the current in one set of wires is at maximum when the other is at minimum. The three-phase current consists of three waves combined on three

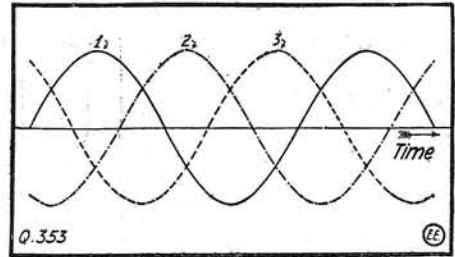

Three-Phase Alternating Current Waves.

wires, and the peaks of the currents are 120 degrees apart; this will be understood from the drawing. It gives a sketch of the current waves in a three-phase circuit. As to the best motor to use, it depends on the purpose to which the motor is being put. A three-phase motor has been found to be very practical, but requires quite an elaborate starting system; it has a good starting torque. This motor is what is known as the inducton type; that is, the fields and the armature have no electrical connection. The two-phase motors operate on the same principle, but the windings are wound in two separate coils, not connected. The single-phase motor is generally of the synchronous type; that is, it starts as a series-wound direct-current motor, but on reaching synchronism with the supply current the connections to the armature are automatically cut out and the motor operates in synchronism with the alternating current supplying same.

HORSEPOWER QUERY.

(354.) Felix Washakas, Chicago, Ill., desires to know the horsepower of a motor required to move 100 pounds at a rate of 1,320 feet per minute on a level surface, and the amount of current it will take to run the motor.

A. 1. As you do not give any clue to the coefficient of friction in your letter, we have figured out the required power of if the weight was being lifted vertically. It would require a 4-horsepower motor to move 110 pounds the required number of feet per minute in a vertical direction, but if the weight is mounted on wheels or rollers the power required will drop to about 10 per cent. of this amount. It will require 28 amperes at 110 volts to run the 4-horsepower motor, and if the power is to be applied horizontally the amperage will drop to 2.8 approximately, and the horsepower to .4.

AERIALS AND RANGES.

(355.) Edward Jones, Fairmont, W. Va., asks several questions: 1. The efficiency of the spiral aerial as compared to that of the straightaway. 2. The wave length of a spiral aerial 14 inches in diameter, 60 feet long, which contains 800 feet of Antenium wire. 3. What is the time of operation of the Sayville station. 4. What high-power stations should he be able to receive from. 5. The advantage of a large capacity variable condenser.

A. 1. We have had no experience with a spiral aerial. From reports, we believe it to be very efficient, but for all-round amateur work we advise the construction of a straightaway aerial, as it has given great satisfaction in the past.

A. 2. The wave length of the spiral aerial containing 800 feet of wire will be between 1,200 and 1,400 meters.

A. 3. Sayville is still in operation, but is under U. S. Government control. It sends press every evening from 8 to 11.

A. 4. You should be able to hear the N. A. I. and W. H. E. Marconi stations at (Continued on page 356.)

"EVERYTHING FOR THE EXPERIMENTER" IN THIS "THE LIVEST CATALOG IN AMERICA"

THE ELECTRO IMPORTING COMPANY CARRIES THE LARGEST STOCK OF EXPERIMENTAL, ELECTRICAL AND WIRELESS GOODS IN THE WORLD. We are the originators of the Wireless Experimental business in the U. S., selling the first wireless outfit in 1904. Our wonderful facilities enable us to give you delivery in 24 hours. WHEN ORDERING GOODS FROM THIS PAGE ENCLOSE POSTAGE ELSE GOODS MUST BE SHIPPED BY EXPRESS COLLECT. The goods shown here are only a small part of our entire line which is fully described in our 275-page Cyclopedic Catalog, which weighs 1/2 lb., is 6 3/4 x 5 1/4 inches in size and contains 2,000 articles, 658 illustrations, 30 diagrams and tables, full Morse Continental and Navy Code Charts, besides "Treatise on Wireless Telegraphy," list of call letters of all U. S. Gov't and Commercial ship and shore stations. This wonderful Cyclopedic sent free if you send us 4c. in stamps or coin to cover postage only. WE SELL MERCHANDISE, NOT CATALOGS. "Why buy Catalogs when the best is free?" Use coupon below to send for Catalog, enclosing 4c. for postage only.

<p>2392 Boy Scout Knife. Has 2 excellent quality steel blades, stag handle and a chain to guard against loss. Chain is detachable at will. Length 3 3/4 in. Sh. wt. 4 ounces. Price.....\$1.50</p>	<p>2422 Upright Caloric Engine. Runs by hot air. Simplest model engine possible to construct. Is very durable. No steam or water used. Size 9 1/2 x 4 1/2. All cylinders of brass. Sh. wt. 4 ounces. Price.....\$1.95</p>	<p>3418 Smallest Flashlight Made. Nickel case, tungsten lamp, long life battery. Gives a very powerful light, is very handy and fits in vest pocket. Size 2 1/2 x 1 1/4 x 1 1/8. Sh. wt. 4 ounces. Price.....\$1.50</p>	<p>1119 Telegraph Key. Double circuit. Rubber comp. base and knob. Has three rubber comp. binding posts. Metal parts nickelled. Size 2 1/2 x 3 1/2. A wonderful value. Sh. wt. 1 pound. Price.....\$1.35</p>	<p>1550 Inter-Ocean Wireless Receiving Outfit. Has loose coupler, galena detector, Jr. fixed condenser and 7000 meter loading coil all mounted and connected on polished oak base. Size 10x12x2 1/2. Sh. wt. 10 lbs. Price.....\$8.00</p>	<p>WIRELESS DETECTOR Wireless Detector. Guaranteed to receive long distance messages or money back. Base hard rubber comp. Metal parts nickelled. Galena crystal supplied. Size 2 x 1 1/2 x 1 1/2. Our cyclopedic sent free with it. Price prepaid.....\$1.10</p>
<p>2365 Rugby Football. Made of pebble grain leather, lined with duck. Bladder guaranteed against accident, wear or abuse for one year. Most wonderful value ever offered. Standard size. Sh. wt. 2 lbs. Price.....\$1.90</p>	<p>810 Dynamo. 8 volts, 10 amperes. Very heavily built for auto. lgt., charging batteries, electroplating, etc. Excellent power motor on 8 volts, made to last. Size 8x5 1/2 x 5 1/2. Sh. wt. 20 lbs. Price.....\$9.00</p>	<p>5000 Rheostat. Porcelain Base (Pat'd). Resistance 10 ohms, maximum capacity 3 amps. continually. Invaluable for dimming lamps, regulating motors, etc. Diameter 4 inches. Controlled by 1" knob. Disconnects on off side. Binding posts rubber comp. Sh. wt. 2 lbs. Price.....\$1.60</p>	<p>5707 X-mas Tree Lighting Outfit. For 110 volt house current. Has 10 colored lamps, red, blue, white and green, arranged in two festoons. Absolutely safe and complete with cord and plug. Size 3x3x3. Sh. wt. 3 lbs. Price.....\$4.05</p>	<p>100 Hustler Motor. Runs wonderfully on one dry cell. Will operate small toys, beautifully finished and very strong. A wonder for the price. Size 3x3x4. Sh. wt. 1 pound. Price.....\$1.85</p>	<p>7199 Revolver Flashlight. Exact model of automatic revolver, shoots brilliant light when trigger is pressed. Contains tungsten lamp and battery in handle. Surprise your friends. Size 4x2 1/2 x 1 1/2. Sh. wt. 1 lb. Price.....\$1.95</p>
<p>16003 Electric Lighting Outfit. 8 volt 150 watt capacity. Includes generator, switch board with meters, etc., 1/4 H. P. gasoline engine, storage battery, fuses, wire, belt, hydro meter and plans. Capacity 15 lights. Sh. wt. 185 lbs. Price.....\$74.00</p>	<p>3356 Radio Nitrogen Battery. Gives 8 volts and is same size as standard No. 6 dry cell. Wonderfully efficient. Made of extra high grade materials. Used for lanterns and experimental work. Size 6x 2 1/2. Sh. wt. 3 lbs. Price.....\$3.35</p>	<p>1331 Dynamo. Very powerful, gives 6 volts 6 amperes, lights, 12 tungsten lamps, charges storage cells, runs as a power motor, etc. Not a toy. Size 6x6x6 inches. Sh. wt. 7 pounds. Price.....\$3.70</p>	<p>Free Wireless Course consisting of 20 lessons, total 160 page, cloth binder size 7x10 1/2 in. with 350 illus. 30 tables. Coupons for this Free Wireless Course in our Cyclopedic Catalog.</p>	<p>1024 Telephone Receiver. 75 ohms. Hard rubber comp. powerful magnet. With two receivers and no battery, you can talk 500 feet. Size 2 1/4 x 1 1/4 inches. Shipping weight 1 pound. Price.....\$1.40</p>	<p>1547 "Presto" Hand Lamp. Fits on any dry cell and will burn for 50-75 hours. No danger and always ready. Supplied complete without battery. Reflector is adjustable. Size 6x3. Sh. wt. 7 lbs. Price.....\$1.75</p>
<p>2420 Upright Steam Engine. Has water gauge, whistle, large balance wheel and will operate on kerosene and petroleum. Tested before shipment. Directions included. 11 in. High. Sh. wt. 3 lbs. Price.....\$1.95</p>	<p>5602 Trolley Car Outfit. Wonderful value, will run on dry cells. Outfit consists of trolley car, controller, electric headlight and 15 1/2 feet of straight and curved track. Car size 12x6x4. Sh. wt. 10 lbs. Price.....\$5.65</p>	<p>4300 Pocket Ammeter. Range 0-30 amperes. Pocket size. Finely nickel plated, accurate, dependable and handy. Invaluable for testing dry cells. Diameter 2 1/4 inches. Net weight 4 1/2 oz. Sh. wt. 1 lb. Price.....\$1.80</p>	<p>2421 "Presto" Bicycle Lamp (electric). Operates almost 50 hours on one dry cell. 2 1/2 inch reflector is fully adjustable. Fastens on handle bars. Battery container included but no battery. Perfectly safe. Sh. wt. 2 lbs. Price.....\$1.15</p>	<p>1088 Spark Coil. Gives 1 inch flaming spark on 6 volts. "Bull Dog" style that's copied but never equalled. Oak frame, platinum points. Rubber comp. binding posts. Size 7 1/4 x 5 1/4 x 6 1/4. Sh. wt. 6 lbs. Price.....\$4.00</p>	<p>3352 Printing Press (Self-Inking). Will print a form of 2 1/2 x 3 1/2 in. Includes 5a font, of 175 characters, type case, gold and silver bronze, ink, cotton, cards, etc., with instructions. Not a toy. Size 14 x 7 1/2 x 5 1/2. Sh. wt. 25 lbs. Price.....\$3.00</p>

THE ELECTRO IMPORTING COMPANY

"EVERYTHING FOR THE EXPERIMENTER"
236 FULTON STREET, NEW YORK

Write your name and address in the Margin below

CRYSTALOI

THE NEW-BB-

The New Type -BB- CRYSTALOI is a SUPERSENSITIVE Detector comprising every accessory and refinement in A SINGLE UNIT

It consists of a highly finished African mahogany case in which is located a super sensitive Crystal cylinder of which the periphery protrudes through the top making it accessible for rotating to secure finest adjustment. A cohering inductance especially calculated and calibrated to the super-sensitive cylinder. A fixed condenser with the exact capacity for this particular cylinder. A specially wound Buzzer of which the frequency is controlled by a knurled screw head mounted on the front of the case to produce a note that is best suited to assist in cohering the alloy in the cylinder. Two of the highest grade dry batteries to operate the Buzzer and a Buzzer control button which protrudes through the top of the case for accessibility.

With this carefully designed and calibrated instrument you have but to set it on the table, connect your phones and leads from your tuning coil and you are permanently and thoroughly equipped to engage in the most serious wireless work of the present day. Of course Variable Condensers can be added if desired.



Dimensions $7\frac{1}{2}$ x $5\frac{1}{2}$ x $3\frac{1}{2}$ high
Mailing Weight 3 Pounds. Price **\$12.00**

— Other Types of the Crystalloi —

CRYSTALOI TYPE O
Very Sensitive



Dimensions $2\frac{1}{4}$ x $1\frac{1}{2}$ in. ORDER A CRYSTALOI TODAY AND
Mailing Weight 1 Pound. STOP YOUR DETECTOR
PRICE, \$3.50. TROUBLES

CRYSTALOI TYPE AA, Super Sensitive
TWENTY-ONE HUNDRED MILES
IS THE LATEST CRYSTALOI RECORD

CRYSTALOI

A PERMANENT WIRELESS DETECTOR THAT HAS MADE A WONDERFUL RECORD

You will find wireless men on land and sea using Crystalloi Detectors in preference to any other detector made. They will not burn out or go dead and are ever ready to pick up the minutest currents that are in the air. They are sold under the Turney guarantee and are making their wonderful reputation on real merit. Send today for full description.

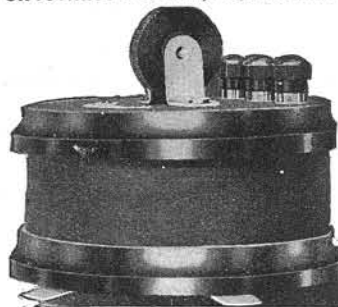

Dimensions 4 x $3\frac{1}{2}$ in.
Weight 2 Pounds. PRICE, \$6.00.

OUR WIRELESS ACCESSORIES

THE NEW TURNEY VARIABLE CONDENSER

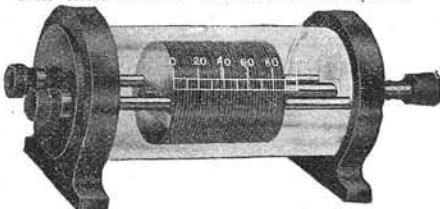

Dimensions: $5\frac{1}{2}$ x $2\frac{1}{4}$ in. Made in two capacities.
Type X—35 Plates. Price \$3.50.
Type XX—50 Plates. Price, \$5.00.
ORDER ONE NOW

and see what you have been missing.

The New Turney Variable Condenser meets all the requirements of the most exacting wireless man inasmuch as it has more capacity for its size than any condenser ever made. The great advantage lies in the fact that it is provided with round plates of a special alloy $1\frac{1}{2}$ in. in diameter, of which the entire area is available for condensing purposes. This you will find in no other variable condenser.

The New Turney Variable Condenser possesses an absolute zero. This you will find in no other type of condenser. The plates are enclosed in a flint glass tube on which the scale is engraved. It is air and dust-proof and can not get out of order. The dielectric is air, therefore the efficiency is the greatest possible. The ends are of hard rubber composition and are highly finished. A hand-somer and more valuable wireless instrument you never saw.

SEND FIVE CENTS IN STAMPS FOR COMPLETE CATALOG

THE TURNEY ROTARY LOADING-COIL



Dimensions $3\frac{1}{2}$ in. x 1 in. Price \$3.50.
Mailing Weight One Pound.

This is a radical departure from the accepted form of loading-coil for the reason that the entire coil with its switch points revolves while the switch blade remains stationary. This new form of construction makes a much neater and more compact instrument, and the rotating of the coil is a much more natural movement than turning the switch blade. It has a capacity of 4,000 meters divided into sixteen divisions of 250 meters each. When used with the ordinary loose-coupler will give a total capacity of about 4,600 meters. The entire instrument is of hard-rubber composition. The blade is of a silver alloy, which insures the maximum efficiency. The rotary coil has a knurled edge and is provided with a scale divided into sixteen equal divisions.

Eugene T. Turney Company, Inc., 2595 Third Avenue
NEW YORK CITY

QUESTION DEPARTMENT.

(Continued from page 354.)

Philadelphia; you should also hear N. A. R., Key West, and N. A. X., Colon.

A. 5. The advantage of a large variable condenser lies in the fact that you may use large values of fixed inductances in your tuner, which means you may use fewer contacts on the switch of same and get very close tuning. A large variable condenser is generally placed across the primary of the loose coupler for long waves and switched in series with the aerial when you desire to receive short wave lengths.

MIGNON COUPLER AND DR. COHEN'S TUNER.

(356.) Reginald Pink, Bronx, N. Y., wishes to know: 1. The sizes of wire on a primary and secondary of the Mignon coupler. 2. If any of the variable condensers in Dr. Cohen's Navy set may be left out. 3. If the Wireless Association of America is still in existence.

A. 1. We are unable to supply you data upon the windings of the Mignon coupler, as this is a manufacturing secret and is not supplied to outsiders.

A. 2. We think you could use one variable condenser in Dr. Cohen's receiving hook-up by using a double-pole switch in

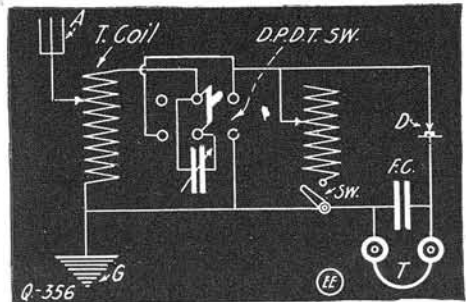

Wireless Receiving Tuning Diagram.

connection with it that will enable you to throw the condenser in series or in parallel with the intermediate circuit as shown in the sketch.

A. 3. The W. A. O. A. is still in existence, and you may obtain all information by writing to the Modern Publishing Co., 239 Fourth avenue, New York City.

THE TELEPHOT.

(357.) W. C. Culver, Indiana, wants to know: 1. Of what scientific value "seeing over a wire" is, or the Telephot. 2. Also a remedy for vibrator sticking.

A. 1. By the perfecting of an apparatus by which it is possible to see over a wire we would be enabled to transmit pictures with a great speed, not to mention the many industrial uses it could be put to. It will enable you to attend a moving picture show by merely going into your parlor and closing the proper switches. You would be able to sit comfortably at home and watch an automobile race 400 miles away. You no doubt know from practical experience when you are personally talking to anyone you can explain your meaning much better, as the expression of the features has quite an effect on the understanding of any information you are trying to convey; thus seeing over a wire would be, so to speak, personally interviewing a man who may be several hundred miles away.

A. 2. Regarding the trouble you are having with your vibrator sticking, would suggest that you clean the points and use a lower voltage on the coil, as it appears

to us that the vibrator has a tendency to weld the contacts together. This may be due to the condenser across the vibrator having become disconnected in some manner, thus causing undue sparking. As a rule vibrators stick due to either using too much current or not having a large enough primary condenser connected across the vibrator points.

ANTENNA QUERY.

(358.) J. Scott Wilson, Piqua, O., sends us a drawing of an aerial he intends to construct, and wishes to know the advantages of this type of aerial.

A. 1. Your aerial possesses no radically new features except the rat-tails, which are separated by means of a spreader where the lead-in is connected. This gives no distinct advantage, and we believe it will be better if you group the rat-tails 15 feet away from the aerial proper.

A SIMPLE ELECTRIC CHAIR.

(359.) D. Causey, Greenville, Ill., asks: 1. For the dimensions of a coupler, the coils to be stationary, using switches for tuning. 2. Where he can get a good tangent galvanometer. 3. If it is dangerous to operate a receiving outfit during a thunderstorm.

A. 1. The dimensions of a coupler of the type you ask about can comprise two coils 6 inches long, the larger one to be about 4 inches in diameter and the smaller to be about 3½ inches in diameter. These are wound with No. 24 and No. 28 wire respectively, and are mounted one within the other and leads brought out to the switches in the usual manner of wiring these couplers.

A. 2. You can get the address of the firm handling galvanometers from the advertising columns of *The Electrical Experimenter*.

A. 3. It is very dangerous to operate a receiving set during a thunderstorm, as the aerial acts as a lightning rod and will draw the lightning into the station, and the operator under these conditions is in danger of electrocution.

CHARGING STORAGE BATTERIES.

(360.) Raymond Johnson, Potter, Neb., wishes to know: 1. If storage batteries can be charged by gravity cells. 2. What size of wire to wind a five-bar telephone generator with to obtain 6 volts. 3. If he can make a good wireless ground by fastening the ground wire to a driven well 256 feet deep.

A. 1. Storage batteries can be charged by gravity cells, but it requires a long time for them to be fully charged. You should use sufficient gravity battery to give about 2 volts more than the storage cells for proper operation.

A. 2. By winding your magneto with No. 20 wire you will be able to get about 6 volts from same, and you can regulate the voltage by changing the speed at which you drive the machine.

A. 3. Fastening the ground wire from your wireless set to a driven well will give an ideal wireless ground, as you are making connection to moist soil.

LEAD SALTS AND THE X-RAY.

(361.) Eric C. Peters, Pennsgrove, N. J., inquires: 1. If all the lead salts have the effect of stopping X-rays. 2. Whether radium rays can pass through lead, or are reflected from it like a mirror. 3. He also asks several questions regarding the length

(Continued on page 359.)

Multi-Audi-Fone

The new wonder in the wireless world. It increases the Audibility 1,500 Times

Read What Others Say

Messrs. Stickel & Stickel, of Connellsville, Pa., say: "We have given your apparatus a thorough test and find that they are all that you claim them to be."

Mr. D. L. Irvin, of Curwensville, Pa., says: "I was surprised with the results from it. Arlington and several other stations came in so loud that I could read them with the 'phones ten feet from my head."

Mr. Ralph Batcher, of Toledo, Iowa, says: "The results were even more than were expected, both at the convention and by other amateurs in Des Moines, who tested the apparatus, and other places."

Mr. John Tucker, Jr., of Elizabeth, N. J., says: "After a thorough trial, am astonished at the results obtained. . . . Combining, as these instruments do, the greatest degree of efficiency coupled with extreme compactness, they are, without doubt, the finest instruments offered to the amateur and professional wireless field at large."

W. O. Horner, of Cleveland, Tennessee, says: "I have been trying your Multi-Audi-Fone out as an Amplifier. . . . I was more than surprised at its sensitiveness. It is certainly wonderful. . . . I stood at the rear of my store, one hundred and twenty-five feet from 'phones, and copied Arlington and Key West, also Tampa, Florida. I consider that some amplifying for way down here on Inland."

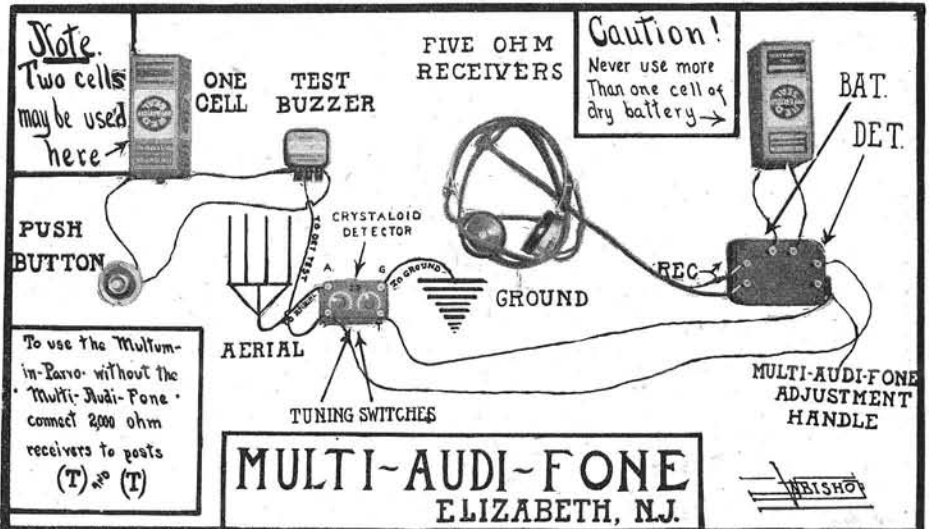

- Multum in Parvo Receiver, including Crystalloid Detector and Buzzer - \$20.00
- Multi-Audi Fone, including our Specially Wound Head Set - \$30.00
- The Matchless Christmas Present. Our Complete Wireless Set, Only - \$50.00

Talking Multi-Audi-Fone

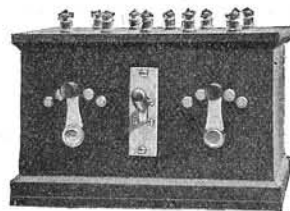

Size, 4½" x 5" x 7".

The amplification is so great with the Talking Multi-Audi-Fone that the signals can be read all over the five-story building from our laboratories, which are located on the third floor. If the windows are opened, the signals can be heard across the street, even when the trolley is passing.

Price, including horn - \$100

Telephone Voice Multiplier

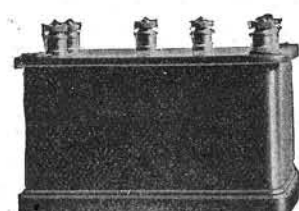

Size, 2¼" x 3¼" x 4½".

The Telephone Voice Multiplier has been made possible by applying the principle employed in our Multi-Audi-Fone to the telephone receiver. The voice can be distinctly heard coming over 1,000 or even 2,000 miles of wire that would be indistinct coming over 100 miles of wire. Buy a Multiplier and stop straining to get something you can't hear. Price \$15.00

Send for circular to-day **MULTI-AUDI-FONE** 273 Morris Ave. ELIZABETH, N. J.
Ask your dealer to-morrow

BUY YOUR XMAS WIRELESS NOW

BIG REDUCTIONS FOR NOVEMBER ONLY

Save 25% If You Act Quickly

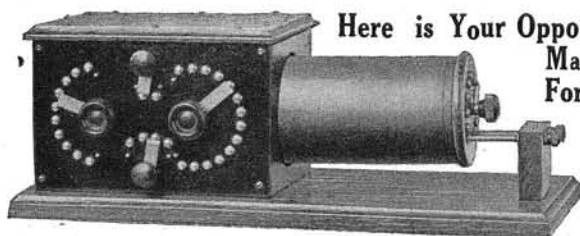

Here is Your Opportunity to Secure the Best Navy Type Loose Coupler on the Market. Regular Price - - - - \$15.00 **\$10.00**
For November Only—Reduced to - - - -

A brass lacquered 6,000 meter inductance tuner, perfect in every detail. Equipped with four point loading inductance which increases the wave length 4,000 meters over the average Navy Type Transformers. The primary winding has 24 taps—one switch controls the primary in groups of tens, the other controls one turn at a time—and is equipped with a dead end switch. Enclosed in a cabinet, the front of which is polished hard rubber. The secondary coil is wound with double silk covered wire and the inductance is varied by a ten point switch. With this coupler the very finest and most accurate tuning is easily and quickly secured. With a good sized aerial the reception of wave lengths up to 6,000 meters is possible.
All Finished Parts Ready For Assembling With Full Instructions - - - \$6.50

Our No. 810 Complete Sending and Receiving Station

Sends up to 12 miles.
Receives up to 1,000 miles.

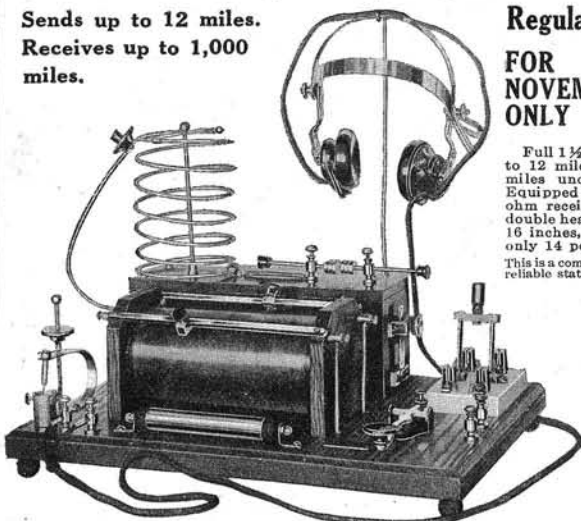

Regular Price \$20.00
FOR NOVEMBER ONLY \$14.00

Full 1 1/4" inch coil type. Send up to 12 miles. Receives up to 1,000 miles under favorable conditions. Equipped with 2 double pole 1,000 ohm receivers, 6 feet silk cord and double headband. Size of base 12 x 16 inches, height 13 inches, weight only 14 pounds.
This is a completely equipped and thoroughly reliable station, mechanically and electrically perfect and ready for instant use. Nothing better in this class was ever constructed. The new improved tuning coil enables you to tune in or tune out any party you might desire, thus eliminating any interference. The set consists of a 1 1/4" in. Spark Coil, 12 Flat Plate Condensers, our "Don't Jar Out" Detector, Buzzer and Switch to tell if your detector is working, Double Slide Silk Wire Wound Tuner for long wave station capacity, Fixed Condenser, Hex Key, DPDT Switch and complete 2,000 Ohm Headset.

Receive The Time From Arlington

AND ALL NEWSPAPER AND SHIP REPORTS
OUR SPECIAL TIME
SIGNAL RECEIVING OUTFIT **\$8.10**
REGULAR PRICE \$10.85

This is our new 1915 model made of the highest grade material obtainable. Double slide coupler for close tuning is wound with No. 24 green silk covered wire on the primary — the secondary with No. 28. There are 8 points to divide its capacity. A 3,000-metre loading coil placed between the coupler and the aerial by a switch that throws it in or out of the circuit enables you to receive amateurs with the coupler alone and long wave stations by the addition of the loading coil. One fixed condenser of proper capacity, improved universal detector, one buzzer test to test your mineral, and potentiometer. This instrument is assembled on a highly finished oak base. All metal parts are heavy nickel-plated.
This station, with our Navy Type Loose Coupler, as illustrated above, \$15.00

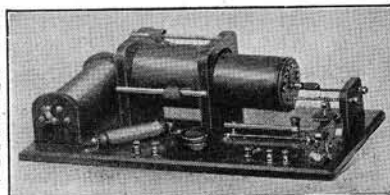

OUR No. 401 SENDING AND RECEIVING STATION

Regular Price - - - - \$5.95 **\$4.95**
For November Only - - - -

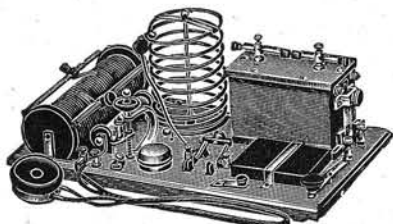

Consists of 3/4-inch coil, fluted end spark gaps, four plate secondary, one collapsible helix, one key, a two-slide tuner, fixed condenser, detector and buzzer test to test your mineral. This set is mounted on a highly finished oak base with all metal parts heavy nickel-plated. With a good-sized aerial, under favorable conditions, will send up to 3 miles and receive up to 300 miles.



FREE!
Complete Gem Station

Receives up to 300 miles. We will give absolutely free a Gem Outfit to every one who sends us the cost of the necessary equipment for it. This equipment consists of:

2000 Ohm Headset.....	\$3.95
16 Insulators.....	.48
1 Ground Clamp.....	.10
500 Ft. of A-1 Wire.....	1.20
20 Ft. of Rubber Cable for lead in.....	.90
TOTAL.....	\$6.63

Send \$6.63 at once and we will include the Gem Receiving Station Free. A splendid outfit for beginners.

Send 6c. in Stamps for Our Big 152 page Wireless and Electrical Catalog "H-80" Containing Hundreds of Wonderful Bargains of All Kinds

Nichols Elect. Co., 1-3 W. Broadway, N. Y.
Manufacturers of Standard Quality Goods Only

You benefit by mentioning "The Electrical Experimenter" when writing to advertisers.

QUESTION DEPARTMENT.
(Continued from page 357.)

of the wire used in an article on the telegraphone that appeared in the June issue of this magazine.

A. 1. It has been found that a mixture of granulated lead and linseed oil is the best lead salt to use in making garments that will protect the X-ray operator from the burning effects of the X-ray. Any cloth may be used for this purpose, but silk, being of such a fine texture, retains the salts much better.

A. 2. Lead is opaque to all the radium rays and acts as a screen, absorbing them and having very little reflecting effect. This applies likewise to X-rays, as you may no doubt understand if we mention that a lead salt is used in making the gowns to protect the operator.

A. 3. The telegraphone was actually constructed for experimental purposes and only 200 feet of wire was used. You may use any length of wire you desire by increasing the size of the spools to hold it. You will be able to purchase steel wire from any dealer in electrical supplies, and he would no doubt be able to quote you prices on small gear wheels.

BLOCKING CONDENSER.

(362.) Frank Haverland, Jr., Madison, Neb., wants to know: 1. The wave length, power and time of operation of the Fort Omaha radio station. 2. Correct capacity for a blocking condenser to be used with a loose coupler.

A. 1. W. V. H. is under Government ownership and is likely to operate at any time of day. The power, we believe, is about 3 kw. and operates on a wave length of 600 meters.

A. 2. A blocking condenser for use with a loose coupler should have a capacity of .075 M.F. If the 'phones are connected across the condenser it is advisable to utilize an adjustable type for this purpose.

AERIALS AND LIGHTNING PROTECTION.

(363.) Allen Sjöholm, Chicago, Ill., asks: 1. How a loop aerial can be connected to a S. P. D. T. lightning switch. 2. Which type of aerial is best for sending and receiving—a loop or a straightaway aerial. 3. If a carborundrum detector requires a battery for its successful operation.

A. 1. A loop aerial cannot be connected to a single-pole double-throw switch for lightning protection, but by adding an extra clip as shown in the drawing it can be done. This protection can then be afforded by wiring the switch as shown.

A. 2. It has been found that the loop aerial is superior for receiving because it is a closed circuit and does not reradiate received energy, while the straightaway aerial is better for sending because it does not require an anchor gap in the aerial.

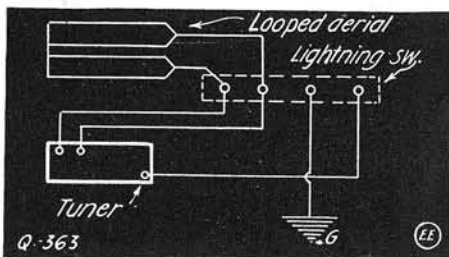

Looped Aerial Lightning Switch.

You may arrange an aerial switch so that you use a loop aerial for receiving and a

straightaway for sending, as shown in the July, 1914, issue of *The Electrical Experimenter* on page 44.

A. 3. A carborundrum detector requires a battery of about 3 volts and a potentiometer for its proper operation, as it requires a close regulation of the voltage to get this detector adjusted to its most sensitive condition.

RECEIVING TUCKERTON.

(364.) Max Clinch, Lakewood, N. J., asks several questions: 1. The use of a tikker on damped waves. 2. Regarding detectors. 3. Schedule and wave length of the Tuckerton station.

A. 1. It is possible to receive time signals from N. A. A. (Arlington) by using a tikker, but it has been found in actual practise that a detector responds best to slightly damped waves. You should use the tikker when receiving from stations which use undamped waves, such as Tuckerton or the Federal Wireless Telegraph Co., which use the Poulsen arc system.

A. 2. It is generally admitted that the galena detector is the most sensitive of mineral detectors, while the ordinary Audion, particularly when used as an amplifier is really the most sensitive extant.

A. 3. The wave length of the Tuckerton station is very high, about 7,500 to 8,000 meters, and it has no special time for operating, being a commercial station, but can be heard nearly every evening about 11 o'clock.

HOOK-UPS.

(365.) Clifton F. Taylor, Waltham, Mass., asks for a hook-up for a wireless outfit.

A. I. Q. No. 355 shows the proper wiring for the apparatus you mention, but we would suggest the addition of a variable condenser to your outfit. This condenser is shown in the drawing and it increases the flexibility and range of the station vastly.

LINE INDUCTION AND VARIOMETERS.

(366.) Casimir H. Jaraszewuz, Chicago, Ill., asks several questions: 1. Whether a

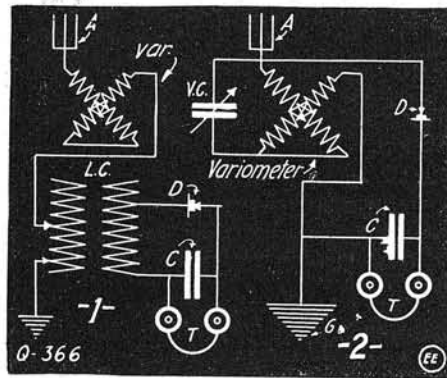

Variometer Hook-Ups.

current of 4,400 volts used for railroad work would affect a wireless set located 200 feet from the said circuit. 2. The principles and construction of a variometer.

A. 1. Since your aerial is located at right angles to the wires carrying 4,400 volts, it will have little or no effect on your set beyond a humming sound that may be slightly noticeable.

A. 2. Drawing shows two connections for a variometer. The first illustrates a variometer used as a loading coil, and the second how it is used by the Telefunken Co. for tuning purposes. A variometer consists of two concentric coils of wire, each containing an equal value of induct-

LEARNING TELEGRAPHY

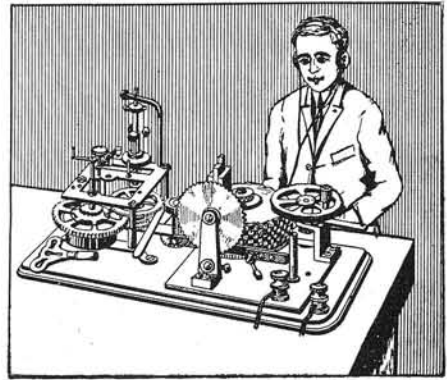

becomes simple when your instructor is the Omnigraph Automatic Transmitter. Combined with a standard key and sounder or Wireless Buzzer, it will send you telegraph messages at a slow speed, which can be increased at will to match the sending of an expert operator as you become more proficient. Adopted by U.S. Gov't. Made in 4 styles, from \$2.50 up, all accurate. Circular free.

Omnigraph Mfg. Co., 39 L Cortlandt St., New York

PHILADELPHIANS KNOW US

You, too, should earn of our large stocks of **Electrical and Wireless Apparatus** and intelligent service. As agents for The Electro Importing Co. and J. H. Bunnell & Co. we assure you of quality merchandise at lowest prices.



Quaker Light & Supply Co., 728 Arch St. Phila., Pa.



Only \$5.00

If you would like to get louder signals, make your station more selective and receive longer distances, get this efficient Receiving Transformer. Send two-cent stamp for Bulletin 105, just out.

Colby's Telegraph School, Auburn, N. Y.

"Construction of the Audion Amplifier"

with working drawings, particularly describing the transformer. Price, 50 cts.

THE MISCELLANY, 17 Board of Trade, KANSAS CITY, MO.

BOSTON WIRELESS

Boston Receiving Transformer, \$7.50
Variable Condenser, 25 Plates, \$2.75
Boston Detectors, \$1.00, \$1.25, \$1.75, \$2.25, \$4.00
Agent for Electro Importing Co. and A. W. Bowman Co., Manhattan and Adams Morgan Spark Coils, Ever-ready flash lights and batteries.
Catalog for stamp only.

M. MUELLER, 18 Devonshire Street, BOSTON, Mass.

1 Microfarad Condenser

cast in metal box with 2 binding posts. Insulation good for 800 volts
Regular Price, \$7.00; Special Price, \$2.00 for cash with order

Rosenthal Laboratories, Camden, N. J.

WE carry a very complete line of Wireless Apparatus in stock, being Chicago headquarters for the Electro Importing Co. Same prices, same goods and Free Wireless Course. The Static Machine shown here is an example. Just turn the handle and get 2 and 3-inch sparks. Price, \$3.75. No batteries required. We also carry a complete line of Electric and Auto Supplies.



Send 4c. in stamps for our 3 complete catalogs.

Price \$3.75
No batteries required.

LA SALLE LIGHT COMPANY
134-136 N. La Salle St., Chicago, Ill.
(Opposite City Hall)

No. 10 Tungsten Flashlight
6 inches long, complete, 65c. Extra bulb, 15c. Extra battery, 25c.
No. 125 Tungsten, Nickel Vest Pocket Flashlight with Tungsten bulb and Ever-ready battery complete, 49c. Extra bulb, 15c. Extra battery, 25c.
Nitrogen Lamps are the latest type of Electric light and use 50% less current than the old style lamps. They also give you twice the light for the same current.

PRICE LIST			
60 Watt.\$0.90	400 Watt.\$4.00
100 "1.00	500 "4.50
200 "2.00	750 "6.00
300 "3.00	1,000 "7.00

Send 4c. in stamps for our 3 complete Catalogs and bargain sheet of raw material and lesson coupon.

ance. The inner coil has a knob fastened to it, so that the planes of the two coils may be changed. The two coils are then connected in series, and when placed so that they help each other; that is, so that their respective magnetic fields are assisting each other, the inductance is at its highest value. As the inner coil is slowly turned out of the plane of the outer coils the inductance changes, and when turned through an angle of 180 degrees the two coils will be opposing each other and the algebraic sum of their inductances will be zero.

WAVE LENGTHS.

(367.) W. J. Gravely, Danville, Va., inquires: 1. About the stations that have the same sending range as the Arlington station. 2. The wave length Sayville is now using. 3. The sending range of the Wanamaker station in New York and its wave length.

A. 1. Stations on the Eastern coast having a range equal to the Arlington station are: Sayville (W. S. L.), Key West (N. A. R.), Colon (N. A. X.), Tuckerton (W. G. C.).

A. 2. Sayville uses a wave length of about 2,800 meters, and sends "press" to ships from 8 to 11 p. m. daily.

A. 3. The Wanamaker station, New York (W. H. I.), uses 2 kw. and has a sending range of about 250 miles under all conditions, and operates on a wave length of 600 meters.

INVESTIGATIONS IN LECLANCHE PRIMARY BATTERIES.

A new and commercially valuable investigation of the construction and chemical reactions of the Leclanche cell, the form of primary battery used so extensively for ringing bells, buzzers, etc., and in dry cells operating portable flashlights, bells, igniters, etc., has been undertaken by Ernest G. Crocker, of the graduating class in electrochemistry at Massachusetts Institute of Technology.

The polarization was found to be due to an alkali effect of ammonia, previously referred to as hydrogen, and experiments were made with different sizes of the grains of materials contributing the dry battery, and various ratios of one of the materials to the other for efficient work.

It was found that the fineness should be between 1/40 and 1/100 of an inch, and contrary to the custom of some manufacturers, the two constituents should be of the same size. The materials used are carbon and pyrolusite, and the quantity of the latter should be about 60 per cent. of the whole mixture.

Mr. Crocker found the best material for removing the alkaline effect is chloride of zinc. The practical result of batteries constructed according to the formulas deduced from the experiments is that they will remain more constant in current production under light continuous use.

Winger's Closed Core Transformers

14,000 VOLTS
Perfectly Insulated.

1/4 K.W.	\$10.75
1/2 K.W.	15.90
3/4 K.W.	20.50
1 K.W.	25.50

Designed for direct connection, 110 volts 60 cycles without resistance or impedance. Send 6c. for big new catalog.

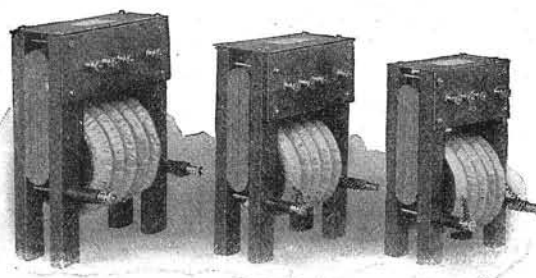

Winger Elec. & Mfg. Co.
711 So. Dearborn St., CHICAGO, ILL.

A New, Efficient, Beautifully Finished Complete Receiving Set

LOOSE coupled, complete receiving set, primary wound with bare wire secondary wound with very fine silk covered wire. Secondary divided up by ten taps which are brought out on end pieces, contact being made by a phosphor bronze rotary switch with a hard rubber knurled knob. A specially constructed detector allowing a very fine adjustment is one of the features of this station.

A fixed condenser of the exact capacity, specially constructed for this size loose coupler, greatly adds to the efficiency of this outfit. All parts built of solid oak and mounted on a solid oak base, beautifully finished.

This station will be sent complete as described with one 80 ohm double pole receiver, headband and cord. \$4.45

Send stamp for our wireless catalogue, and free code chart of unbreakable fibre.

Universal Wireless Co. 19A East 32nd St. New York City. All "Universal" outfits are sold with privilege of 10 days' trial and money back guarantee.



\$4.45
Complete as described

A BOUND VOLUME CONTAINING 12 ISSUES OF THE ELECTRICAL EXPERIMENTER FOR **75c.**
Bound in substantial green cloth; lettered in gold. Postage on 3 lbs. is extra. Book Department. A REAL BARGAIN. EXPERIMENTER PUBLISHING COMPANY, Inc., 233 Fulton Street, New York.

You Can Only secure the best in **FLASHLIGHTS** and **BATTERIES** by insisting that this trade-mark is on flashlight-case and battery. If your dealer cannot supply you with our product write directly to us for Catalogue A2.



"Cigarette"



Beacon FLASHLIGHTS and **BATTERIES** are made in a wide variety of styles and shapes but only **one quality—THE BEST.**



"Ideal Fountain Light."

BEACON MINIATURE ELECTRIC CO., 118-20 DUANE ST. NEW YORK. BRANCHES: CHICAGO, SAN FRANCISCO



"Short-Circuit Proof."

PATENT ADVICE

Edited by H. GERNSBACK

In this Department we will publish such matter as is of interest to inventors and particularly to those who are in doubt as to certain Patent Phases. Questions addressed to "Patent Advice" cannot be answered by mail. Sketches and descriptions must be clear and explicit. Only one side of sheet should be written on.

Telephone Lock.

(28) Henry Lewis, Toronto, Canada, has submitted a model and sketch of a telephone lock and desires to have our advice if it is patentable and whether it is a practical apparatus; it is to be used in locking telephones so that unauthorized parties cannot use it.

A. We have carefully inspected the model and drawings and find that as far as we can tell the invention is original. We think there is a good chance to obtain a patent on it.

We would, however, desire to caution our correspondent that up to this time telephone locks have not been very popular and they are hardly ever used at all for some curious reason.

Foreign Patents.

(29) Victor Stefano, Newark, N. J., wants to take out a patent, and he is particularly interested in obtaining patents also in Germany, France and England. He wishes to know if we can give him the addresses of some trustworthy attorneys in these countries.

A. It is common practise that if you take out a patent in this country that you let your attorney take care of your foreign patents also. Nearly all reliable attorneys in this country have corresponding attorneys in Europe, as well as the other continents, and they are in a position to do the work better for you in this manner than if you sent the patent direct to foreign attorneys.

Gun-Flashlight.

(30) Alfred S. Turner, Lynn, Mass., has sent us a description and draft of a gun-flashlight, the idea being that the flashlight is operated by means of a trigger before firing the gun.

A. This invention is not new and various patents have been allowed on precisely the same arrangement. We believe there is a concern in existence now that manufactures revolvers that have a flashlight mounted underneath the barrel, and from this you can see that there is hardly a chance of your obtaining a patent on this idea.

Nickel Plating Paste.

(31) Howard Armstrong, San Diego, Cal., has invented a nickel-plating paste and submits a sample of the paste to us. He wants to know whether a formula of this kind can be patented and whether such an article is in demand.

A. We have examined the paste in question and find that it works indeed very well and seems to give a good plating as far as we can tell. We have not made an analysis of the paste to find out what it contains, nor do we know if the nickel-plating will not peel off in time.

There is probably a good chance that a patent can be obtained on the formula, though we cannot be certain, for the reason that quite a good deal of this work has been done before.

A very large concern a few years ago started to sell some nickel, silver and gold powders which gave an electro-chemical deposit simply by wetting the powder. We

understand that while the article was a very meritorious one, the company went out of business as there was probably not sufficient demand for the article. A large advertising campaign was carried on, but it seemed to be of no avail.

Incandescent Lamp.

(32) Alfred Schneider, Boston, Mass., has perfected an electrical invention covering an incandescent lamp and he desires to know whether he could go ahead manufacturing same or selling it to a manufacturer as soon as he has applied patent on the invention; he furthermore wishes to know how long it takes an invention to be patented at the Patent Office.

A. We most strongly advise against doing any commercial work on an invention or offering it for sale before the patent has been allowed. It sometimes takes years to get a patent, particularly in an art where much previous work has been done, as, for instance, in your invention. You are probably aware that there are hundreds of patents in existence on incandescent lamps and it is therefore almost certain that it will take a minimum of one year before the patent can issue. Of course, this is presuming that the invention is an improvement over something else. If, however, the invention is radically different from anything existing so far and presents a basic idea, it probably would take quite a little less time for the patent to issue.

As a rule we would caution inventors not to enter into any agreement with any firm or individual to manufacture an article which has not been patented. Only in extreme cases does such a course prove profitable. The reason for this is that very often the first idea of the invention is very crude and the article in question will stand quite a lot of perfecting. For this reason if an invention is given to a manufacturer and he should improve upon it in such a way as to alter the original invention the inventor would have no recourse in case the manufacturer desired to manufacture the article in question without paying the inventor royalties.

DODGES HURRICANE BY AID OF WIRELESS TIP.

The 85 passengers recently arrived at New York from Central American and West Indian ports on the United Fruit steamer Pastores wrote their thanks to Captain Henshaw for bringing them home in calm weather.

From the time the Pastores left Port Limon until she was reported off Sandy Hook Captain Henshaw received wireless reports enabling him to keep out of the hurricane's zone.

PATENTS THAT PAY

OUR TRADE-MARK
OVER \$600,000.00 MADE BY CLIENTS

PATENTABILITY REPORT

Send sketch or model of your invention for free search of the Patent Office Records and report as to patentability.

TWO WONDERFUL BOOKS FREE:

Entitled "Inventors Guide" (146 pages) and "What and How to Invent—Proof of Fortunes in Patents" (127 pages)

Highest References, including 100 manufacturers we serve.

PROMPTNESS ASSURED

Across the Street from the U. S. Patent Office

E. E. VROOMAN & CO., 870 F Street, N.W., Washington, D. C.

PATENTS AND TRADE MARKS

LANCASTER & ALLWINE
D.C. Washington, D. C.

252 Ouray Bldg., Washington, D. C.
Book "Inventions—Patenting & Promoting" Free

Our co-operation with an inventor is, FIRST, to help him establish his rights before he discloses the idea to ANY attorney. SECOND, to give a frank opinion whether it will pay to patent his idea, based upon our extensive knowledge of manufacturers' wants and facilities. THIRD, to obtain for him a patent which is in reality a valuable monopoly. FOURTH, to advise and assist him in the profiting by outright sale, territorial grants, obtaining royalty, or independent manufacturing of the invention and FIFTH, aiding him to so profit by conferring with manufacturers, investors or distributors of machinery.

Before sending a sketch to anyone, sign, witness, and deposit in our fire-proof vault our document

EVIDENCE OF CONCEPTION AND ESTABLISH YOUR RIGHTS

PATENTS

THAT PROTECT AND PAY

Books and Advice Free

Send sketch or model for search. Highest References. Best Results. Promptness Assured.

WATSON E. COLEMAN, Patent Lawyer
624 F. Street, N. W. Washington, D. C.

PROTECT YOUR IDEAS

Under our plan inventions can be protected at low cost during financial stringency, or while perfecting or testing commercially. Square deal proposition with refundable fees and free investigation if you mean business. Send for free booklet and references.

Milo B. Stevens & Co., Attys., Estab. 1864
694 F St., Wash., D. C. 203 Monadnock Block, Chicago

PATENTS WANTED

Write for Our Five Books, sent Free to any address. "What to Invent" contains List of Inventions Wanted, with full information regarding \$1,000,000 in prizes offered for inventions, among which are

- \$100,000 for Best Substitute for Gasoline.
- \$50,000 for First Person Crossing Atlantic in Aeroplane.
- \$28,000 for New Substance for Denaturing Alcohol.
- \$50,000 for Best Device for Saving Life at Sea.
- \$10,000 for Machine for Pulling and Topping Beets.
- \$10,000 for Automatic Train Control.
- \$10,000 for Improvements in Postal Service by United States Government.
- \$12,000 for Improvements in Navy Department by United States Government.
- \$10,000 for Improvements in Field Motor Ambulances.
- \$5,950 for Miner's Electric Lamp.

We have a special department devoted to Electrical inventions and having secured many valuable patents in this class we are in a position to advise and assist inventors in this field in the development of their inventions.

FREE COUPON!
VICTOR J. EVANS & CO., Patent Attorneys
NEW YORK OFFICES: 189-191 Broadway PHILADELPHIA OFFICES: 1429 Chestnut St.
Main Offices: 779 9th Street, N. W., WASHINGTON, D. C.
GENTLEMEN: Please send me FREE OF CHARGE your FIVE Books as described above.
NAME ADDRESS

You benefit by mentioning "The Electrical Experimenter" when writing to advertisers.

BUILD YOUR OWN GRANDFATHER'S CLOCK WITH OUR HELP



We furnish blue prints, finishing material and instructions. Buy the works, dial, weights and pendulum from us at surprisingly low prices. You make a fine profit building artistic clocks for your friends. Complete works, \$5.00. Others with chimes at all prices. Ask for attractive free offer.

Clock Company
1661 Ruffner St.
PHILADELPHIA, PA.

EXPERIMENTERS—INVENTORS

Let us develop your inventions and make your working models. Our well equipped shop and staff of experienced model builders are at your service. We carry a complete stock of gears. Shipment made same day order received. Send 4c in stamps for booklet Inventors' Supplies.

UNION MODEL WORKS, Established 1882
119 S. Clark St., Chicago

Experimental and Model Work ELECTRICAL INSTRUMENTS AND FINE MACHINERY

Inventions developed. Special Tools, Dies, Gear Cutting, Etc.

HENRY ZUHR
32-34 Frankfort Street New York City



BRASS GEARS cut by an entirely new process. The most accurate made and at prices that cannot be equalled by others. Every gear has a hub, center painted ebony black, edges turned true, highest grade red brass, and much heavier than others. We carry the largest stock in the world, and every gear listed is always shipped on date of order. SEND FOR CATALOGUE

CHICAGO STOCK GEAR WORKS
20a So. Fifth Ave. :: Chicago

Experimental Work at Reasonable Prices TOOLS AND DIES

Light Machinery Designed and Built. Automatic Machines. Cams Cut Exactly to Templet

GEO. SCHWARZ & CO.
123 Liberty Street NEW YORK
Send sketch or blue print for estimate



Armature Discs AT FACTORY PRICES

Any size from 2 1/2 inches to 14 inches in diameter. Best grade material with japanned insulation on one side. Send stamp for circular.

FRED. R. HEILMAN
444 Niagara St. Buffalo, N. Y.

Build a WAR AEROPLANE

"Ideal" accurate Scale Drawings and knocked down parts will enable you to build EASILY exact 3-ft. Flying Models of those Aeroplanes, now used in the European War. America Must Rely On Her Boys to develop her Aeroplanes. Study Aeronautics. Build a model man-carrying machine. We will send you 3-ft. Scale Drawings with building and flying instructions at following prices:

Curtiss Flying Boat	25c
"Military Tractor	25c
"Hydroaeroplane	35c
Nieuport Monoplane	25c
Bleriot Monoplane	15c
Taube Monoplane	25c
Wright Biplane	25c
Cecil Peoli Racer	25c

Complete Set of Eight, \$1.60 Postpaid.
JUST OUT—50-page Aeroplane Book, with full information about Model Aeroplanes and Supplies, 5c. postpaid

IDEAL AEROPLANE & SUPPLY CO., 76-82 W. B'WAY, N. Y.



VENTRILOQUISM

Taught Almost Anyone at Home. Small cost. Send today 2-cent stamp for particulars and proof.

G. A. SMITH, ROOM B 378, 823 BIGELOW ST., PEORIA, ILL.

EDITOR'S CHAT.

You will observe that we have increased the size of the *Electrical Experimenter* once more, the fifth enlargement in seven months. Nor are we going to stop, for there will be a further increase in pages next month. Where else can you find a similar 10c. magazine containing 72 pages, 118 illustrations and 120 articles? Where else can you find the latest and most up-to-date electrical matter and such illustrations as are presented month in and month out in this journal? You know by this time that each and every issue eclipses the one preceding it, and you know what to expect. If money and brains can produce a better magazine than ours, we would like to see it.

There will be some distinctly new features in the December issue, which we know will please the wireless enthusiasts—something entirely new; watch for it. There will also be some very original stories, up to our usual standard and even eclipsing former ones.

As you see, we are doing our utmost to please you and to give you the very best to be had anywhere, and all we ask of you to-day is your co-operation, to make this magazine still bigger, still better. Surely you have a friend or an acquaintance who perhaps has not seen the latest issue of the *E. E.* Why not help the good work along by sending his name to us TO-DAY, so that we can send him a sample copy?

Also, as we stated once before, we could never hope to publish such a wealth of matter if it were not for our advertisers. The advertiser "pays the freight" and he it is who has made the *Electrical Experimenter* what it is to-day, the foremost popular electrical magazine in this country.

Is it therefore not up to you to patronize him to the best of your ability? We strongly urge you to send for the advertisers' catalogs and literature, even though you do not immediately intend to buy. Keep posted, keep up-to-date. Also remember that an "ad" is expensive, and for that reason the advertiser is not always in a position to state his full story in a small space. His catalog or literature is often as interesting as a magazine and frequently more interesting. It is your duty to possess it.

You see it's up to you if you want a still bigger and still better magazine. Can we count on your hearty support?

And lest we forget: Order your December issue now. It will be a hummer!

TO ESTABLISH WIRELESS IN NORTH.

To establish a line of wireless stations in Southeastern Alaska, which will afford that territory wireless connections with the world-wide wireless service which the Marconi company is planning, is the latest ambition of that corporation. Stations will be located at Ketchikan, Juneau, Sitka and Skagway and a low rate night letter service between Seattle and these stations will be established.

Boys—Here's Fun!



ASK DAD FOR THIS TRAIN

STOP LOOK LISTEN

Write Quickly for Our New Catalog

telling how you'll have barrels of fun with a Lionel electric locomotive, Pullmans, freight cars, switches, semaphores, electric lights, track, etc. Make the trains scoot. Run 'em on batteries or a Lionel transformer which saves batteries. (See cut below.)

250,000 boys own them—Join us. Lionel Electric Trains are safe—no shocks. They're steel—not Cast Iron—and won't

LIONEL TOYS ELECTRIC

break. Not high priced. Unconditionally guaranteed. Finished handsomely in colors and gold.

IF Your House Has Electricity Buy This Transformer

BOYS' BIG CATALOG FREE

Written specially for YOU, crammed full of pictures. Section of Lionel Rail Free—Most toy dealers, electrical stores and department stores sell Lionel Toys. Go to your Toy Dealer, find out if he sells Lionel Trains, tell me when you write for catalog—then I'll include a special section of rail—free.

J. Lionel Cowen, A Friend of Boys, President

THE LIONEL MFG. CO., 48-52 East 21st Street, Dept. 50, New York City



For Those Cramped Corner Jobs—

You need a tool that "gets in" quickly and effectively.

MILLERS FALLS Hand Drill No. 306

is designed for just such delicate work. A handle of convenient shape contains twist drills of all sizes to fit its famous Star chuck. Solid steel frame. Nickel plated parts and encased steel pinions. A beautiful and efficient tool.

TO SEE IT WORK IS TO WANT IT

Your dealer will show you or you may write for our new catalogue.

MILLERS FALLS TOOLS

Millers Falls Co.
Millers Falls, Mass.
N. Y. OFFICE:
28 WARREN ST.

You've always wanted a really good flashlight, haven't you?

ONE that won't short-circuit in your kit or go back on you when you needed it most.



Flashlights

are quality flashlights — awarded highest honors—gold medal—at the Panama-Pacific Exposition. Give a powerful stream of brilliant white light, just where you want it; convenient, safe and economical. Guaranteed to give you satisfaction and service.



The Vulcanized Fiber Case light shown is especially adapted for electrical experimenters. It is the only fiber-case flashlight made which you simply can't short-circuit—a patented wireless feature prevents it.

Insist on a genuine "Franco" flashlight. Your dealer probably has them in stock. If not, write us for an interesting catalog No. 9.

INTERSTATE ELECTRIC NOVELTY CO.

29 Park Place NEW YORK
Chicago San Francisco
Toronto

BOY ELECTRICS Knapp Marvelectric THE GREATEST

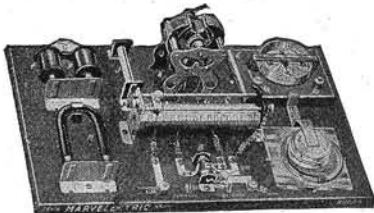

EXPERIMENTS NUMBERLESS

More fun, more information than a hundred books. Finished as shown. Demonstrates Magnetism, Solenoids, Resistance, Motors, Dynamos.

Price \$3.75

Live dealers everywhere. Order direct, or ask your dealer to show you the Knapp Line and insist on getting Knapp Goods.

Dealers not already handling the Knapp Line should ask for prices.

Catalogue illustrating many specialties on request.

KNAPP ELECTRIC & NOVELTY CO.

523 West 51st St. N. Y. CITY

BOYS! Best Boy's Magazine in the world at the price DO YOU LIKE RATTLING GOOD STORIES!



Are you interested in baseball and athletics, electricity, mechanics, photography, carpentry, stamps and coin collecting, amateur journalism, gardening and pets? If you are sit down right now and send a quarter for a year's subscription to Boys' Companion a large 32 page illustrated boys monthly magazine. It is chock-full of the very best boys' stories, clean and wholesome, full of life and action, and has regular departments every month on all the above subjects besides special articles of great interest to boys. **ALL BOYS WANT IT!** If you will send 25 cents at once for a year's subscription we will mail you a copy of Connie Mack's new Booklet.

"The Secret of Success in Baseball" FREE One year 25 cents, Half year 15 cents, Three months for 10 cents. Boys' Companion, 104 South La Salle Street, Chicago, Ill.

NEW AUTO SEARCHLIGHT WITH OUTSIDE FOCUSING ADJUSTMENT.

A new automobile auxiliary searchlight is provided with an outside set-screw focusing adjustment, which permits the use of any style lamp either Mazda or Nitrogen, regardless of size or voltage, and makes it possible to adjust the lamp instantly for any kind of beam without disturbing it in any way or removing it from its position.

Due to this accessible adjustment, the lamp may be transferred from one car to another of different voltage at will. It also enables the user to select a bulb to suit his requirements, and in case of accident to use any available bulb as a renewal. Should it become necessary to use the searchlight to take the place of the headlight, the width of the illuminated field can be increased as desired.

Another feature of this ingenious search lamp is the double curvature parabolic reflector which, though only five inches in diameter, produces as much beam candle power as any large automobile headlight, with even distribution of light.

A minor feature but one of considerable convenience is the design of the handle, which serves as a stand for holding the lamp in an upright position when detached for repairing tires, etc.

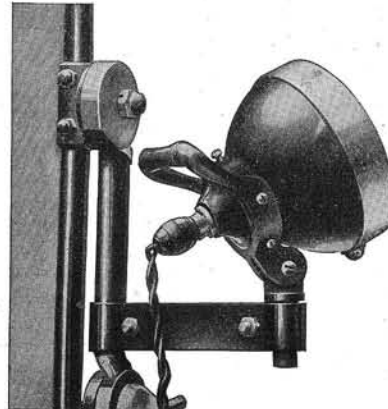

Auxiliary Searchlight for Autos.

BRITISH RELEASE AMERICAN WIRELESS OPERATOR.

C. J. Maisch, of New York, wireless operator on the Norwegian steamer Seattle and a native-born American citizen, who had been held in custody since the Seattle was captured near the Falkland Islands on March 14 last, has been released as the result of representations made in his behalf by the American Embassy.

The plight of Maisch was made known in July by the American Minister at Montevideo, Uruguay. The Foreign Office informed the American Embassy that the man had sailed on board the steamer Bangor from the Falklands. The next heard of him by the embassy was a report from the American consul at Plymouth, England, who said he had been held to give testimony in prize court in case the Bangor, which has been renamed the Seattle, arrived in Plymouth in charge of a prize crew.

WIRELESS FOR MEXICO CITY.

A wireless telegraph station has been erected in Mexico City, according to a cablegram received at the Carranza consulate from Vera Cruz, and radio communication between the capital and the outside world, it is said, will be established soon. Preliminary trials between Mexico City and Vera Cruz have been satisfactory, according to this report.



The newest ideas in cases are yours to choose from.

Gold strata case. Guaranteed for 25 years.

The Burlington Smashes All Watch Competition Look!

19 Ruby and Sapphire Jewels—
Adjusted to positions—
Adjusted to temperature—
Adjusted to isochronism—
25-year gold strata case—
Genuine Montgomery Railroad Dial—
New Ideas in Thin Cases.

Only \$ **2.50** A Month

And all of this for \$2.50—only \$2.50 a month for the masterpiece of watch manufacture—direct to you—positively the exact price that the wholesale dealer would have to pay. We do not care to quote these prices here, but write—write before you buy. Think of the high-grade, guaranteed watch we offer here at such a remarkable price. Indeed, the days of exorbitant watch prices have passed. Write today.

The Newest Cases

In our new watch book, that we will send to you free and prepaid, you will see illustrated the newest ideas in watch cases. The latest triumphs of the master goldsmiths. Notice especially the Inlay Enamel Monograms, Block and Ribbon Monograms, Lodge Emblems and Diamond Set Cases. All offered direct to you on this startling offer. Send the coupon today.

See It First!

You don't pay a cent to anybody until you see the watch. We won't let you buy a Burlington watch without seeing it. Hold it in your hand and admire it. Notice the design, handsomely shaped—aristocratic in every line. Then look at the works! There you see the pinnacle of watch-making. You understand how this wonder timepiece is adjusted to the very second!

Free Watch Book

Get the Burlington Watch Book by sending this coupon now. You will know a lot more about watch buying when you read it. You will be able to "steer clear" of the double-priced watches which are no better. Send the coupon today for book and our offer.

Burlington Watch Co.
19th St. and Marshall Blvd.
Dept. 3388 Chicago, Ill.

Please send me (without obligations and prepaid) your free book on watches with full explanation of your cash or \$2.50 a month offer on the Burlington Watch.

Burlington Watch Co.
19th St. and Marshall Blvd.
Dept. 3308 Chicago

Name.....
Address.....

Wells Solid Oak Letter File
As GOOD As Ever—At a BETTER Price

No changes in the construction, workmanship or finish.
Capacity 20,000 letters or equivalent of Catalogs, Tariffs, etc. Filed on edge, classified between guide cards for quick and easy finding.
Drawers are dust-tight and roll on Roller Bearings. Self-locking follow blocks hold contents vertically.
Each frame joint interlocked, glued and screwed together. Almost wear-proof. Was \$13.25.
Three drawers, \$10.00; two drawers, \$7.75; see note.
Handsomely finished, Golden, Natural or Weathered, Birch Mahogany slightly higher.

Now \$12
Freight paid; see note.

Note Freight paid on orders of \$10 or more to railway stations in Eastern and Central States. Consistent prices in West and South.

Free "Filing Suggestions"—helpful booklet, solves filing problems. With 96-page catalog "F" of Office Supplies. Catalog "H"—two lines Sectional Bookcases and Sectional Music Room Furniture.

Wells Swinging Desk Stand For typewriter, adding machine, reference books, etc. Fastens to either side of any desk. Swings away when not in use. Locks where you want it. Oak top 14x18 in. on strong, black enameled metal support. Will not collapse or vibrate. Get one for your desk. See your dealer or write

Now \$3
by Post anywhere in U.S.

The Wells Manufacturing Company
205 Union St., Monroe, Mich.
New York Office—75 John St.
Knechtel Furn. Co., Ltd., Hanover, Ont., Canadian Dealers

HIGH FREQUENCY CURRENTS.
(Continued on page 329.)

wire motor, and in further tests made by Tesla with very powerful apparatus it was found possible to make a device of this character operate with simply a ground connection and the other electro-magnet terminal joined to an insulated capacity or plate suspended in the air. He has also, by this and other arrangements, produced a wireless light which can be lighted at a considerable distance from the generating station. He claims in his patents that it is easily and simply possible to thus generate vast quantities of high frequency electrical energy and to transmit it for hundreds, nay, even thousands of miles, where it will be picked by an elevated capacity or aerial joined to a suitable translating mechanism, such as a transformer and motor, etc., having its second terminal connected to earth.

A fact not usually considered and which seems to possess considerable promise in this direction, as well as in many other lines of electricity's application, is that of freezing the high frequency or other circuits so as to reduce the resistance to an inappreciable value. Tesla mentioned this in one of his early patents over 20 years ago, and lately very commendable work has been done in this direction by Prof. Kammerlingh Onnes, of Holland. By suitable refrigerating apparatus of special type, which can produce a cold approaching that of absolute zero, or nearly so, it has been ascertained that if induced currents are set up in such a refrigerating circuit, then it is possible for that initial flow of current to pass on around that circuit for a very considerable period of time before it dies down to zero. In some of the later experiments it was found possible for such a current to oscillate around a circuit for many hours before exact measurements with a galvanometer, properly joined to the circuit, indicated that the current had depreciated in value to any great extent. This is an important point which as yet has remained undeveloped, and it seems very possible that it could be worked out with up-to-date and perfected refrigerating apparatus so as to be applied to wireless telegraph sets, particularly those employing high power, where there is a great amount of heating and considerable losses occasioned thereby. As is well known, in such high frequency circuits the resistance plays a very important part, as it acts directly with respect to the damping of such a circuit.

(To be continued.)

DANIELS NAMES NAVAL ADVISORS.
(Continued from page 323.)

American Society of Aeronautic Engineers—Henry Alexander Wise Wood, New York City; engineer and manufacturer of printing machinery and student of naval aeronautics. Elmer Ambrose Sperry, Chicago; Cornell, '76; founder of Sperry Electric Co. and designer of electric appliances and gyroscope stabilizer for ships and aeroplanes.

WIRELESS STATION AT FT. ADAMS, R. I.

Plans for the erection of a high power wireless telegraph station at Ft. Adams have become known with the arrival of material for the plant. This station, it is understood, will be the first of a projected chain of towers for communication between the principal army centers of the coast. The naval system already covers much of the coast line for that branch of the coast defense.

"RED DEVIL"
Hand Honed and Tested Diagonal Cutting Plier

No. 942
5 in.

will cut the finest silk insulation. The standard electrician's tool for exacting work. Made drop forged steel. "No-Pinch" handles of scientific shape give user a firm grip. Sample 5 in. pair sent for 80c. **BOOK-LET OF MECHANICS' TOOLS FREE.**

Smith & Hemenway Co., Inc., 126 Chambers St. New York City

SELF-SHARPENER FOR SAFETY RAZORS

Insert safety blade (any but Durham Duplex), turn handle few times. Honed and sharpens one operation; keen cutting edge like new. Sent anywhere for \$3. Money back guarantee. **A GENTS WANTED.**

CIRCULAR EE ON REQUEST.

IN.MFG. CO., 1 W. Broadway, New York

TOY TRANSFORMERS

9 Different Voltages

50 Watt . . . \$3.00
100 Watt . . . \$4.50
200 Watt . . . \$6.00

Wireless, Bell and other transformers

Send for Folders

A. R. DARLING
1532 N. Capitol Ave.
Indianapolis, Ind.

PORCELAIN
"THAT'S OUR BUSINESS"

Standard and Special Shapes, Regardless of How Difficult

We illustrate one hard shape we make. A pair of rolls 7 1/2" long and 1 1/4" in diameter with 8 holes on ends and middle. They must be perfectly straight and we make them so. It's hard but not for us. We can make your difficult designs also. Send us blue print for quotations.

Union Electrical Porcelain Works
TRENTON, N. J.

2 H.P. \$35 Auto Throttle Governed Engine for Every Work

There is no other four-cycle engine with automatic auto type of throttle governor on the market near the price. Unlike ordinary low priced engines it is not hit-or-miss—a while governed with irregular speed and wasted gasoline.

It fires every shot with speed regulated by exclusive auto-throttle governor which means even, economical power. It will operate electric light plant, pump water, run separator, churn or froster, chop feed, operate machinery, in fact, it is "the engine for every work."

Hopper cooled complete ready to run, 2 H. P., for only \$35. Direct to you from the factory. Write for catalog.

C. Benninghofen & Sons
Dept. 110, Hamilton, O.

Be a DOCTOR of CHIROPRACTIC

\$75 TO \$100 WEEKLY

The need now for Doctors of Chiropractic is tremendous—your opportunities are enormous. The public is awake to the wonderful advantages of Chiropractic (drugless healing). The possibilities to earn \$10,000 a year or more are here. There's room for you—the field is wide open.

Learn at Home in spare time. No experience necessary.

—anyone can easily learn by our complete simplified, illustrated course and complete set of free charts in life-like colors. Absolutely without cost to you—great offer ever made. Write now for free facts.

Illustrated Book Free Proves how you can become a Doctor of Chiropractic—tells all about Diseases and Chiropractic treatment and what you need to know to become successful in this dignified, prosperous profession. Write today—big free offer is limited. American University, Dept. 440 162 N. Dearborn St. Chicago.

Special Dynamos for Arc Lamp in Moving Picture Shows. Special Dynamos for Charging Storage Batteries. Special Dynamos for Incandescent Lighting. We sell upon payments of \$5 and \$10 per month.

Hobart Bros. Co., Troy, O.

September Morn

WATCH FOB. Exactly like illustration. The latest fob out. Has bewitching little figure of Miss "September Morn" handsomely embossed on heavy metal plate. Beautiful oxidized silver finish. Size of metal 1 3/4 x 1 3/4. Genuine black leather strap. Boys, a real work of art. Classy, alluring. Makes 'em all take notice. Agents wanted everywhere. Dandy sample fob and our great easy money proposition to hustlers sent **Postpaid 25 cents.**

NOVEL JEWELRY CO.
707 Lewis Block Buffalo, N. Y.

\$1.45 GIVEN AWAY—CUT THIS OUT

\$10. Six Volt 60 Ampere Storage Batteries \$6.95.
Special price \$5.50 with this advertisement only.

\$18. Six Volt 80 Ampere Storage Batteries \$8.95. Deduct \$1.45 if you include Advertisement with order.

Other types and sizes from 79c. up. Send stamp for cut price list.

Broadway Electrical Novelty House
Three Stores in N. Y. 421 Broadway
324 Bowery 129 West 125th St.

This is worth **\$1.45**

Don't pass it up—Cut it out.

TELEGRAPHY AND TRAIN OPERATION

Taught by retired railway officer. Railway wires in advanced rooms. Expenses earned. All graduates placed direct in the telegraph service.

Send for Folders and Rates

Pelmar School of Telegraphy, Madison, Wis.
America's Scientific Railway Training School

**UNIQUE ELECTRICAL
SOLDERING IRON.**

The object of this new electric soldering iron is to form or generate heat directly at the point of contact, and only at the spot where the heat is needed for soldering purposes, whether it be electric wires, armatures or cable work.

You do not have to wait for the iron to get hot, as the instant the object to be soldered bridges the two carbon or carbonborundum high-resistance heating points these points glow with a white heat directly at the tips of the high-resistance material, therefore conducting the heat directly to the spot needed.

When the object is soldered, the moment the tool is taken from the work the current ceases to flow, as the circuit between the high-resistance points is opened; this creates a great saving of current and also time. The iron is always ready for use. The high-resistance points will last indefinitely, and if they should become injured can be readily renewed, say the manufacturers.

There is no loss of heat through conduction or radiation, as will be found in the old-style electric soldering iron. It is used in conjunction with a small transformer, and will solder from the smallest to the largest work, depending upon the amount of electrical energy that the iron and trans-



New Electric Soldering Iron.

former are constructed for. Where it takes an ordinary electrical soldering iron of the old style to solder a No. 14 wire splice 10 seconds, this new iron will solder the same splice in from three to five seconds; in fact, any job can be soldered in less time with it than by any other means, whether it be a blow-torch, the old-style electric iron or acetylene gas generator.

This iron is thoroughly covered by patents issued and pending in all principal countries of the world, and a new factory is being built for the sole purpose of manufacturing this new electrical soldering iron.

**RUSSIAN COMPANY OF WIRELESS
TELEGRAPHS AND TELE-
PHONES.**

The annual general meeting of the Russian Company of Wireless Telegraphs and Telephones (Russian Marconi Company) was held in Petrograd on June 13, Vice-Admiral Bostrem, chairman of the board, presiding. The directors' report and accounts for the year ending Dec. 31, 1914, record a largely increased turnover in the business of the company, mainly due to orders received from the Russian Government. The company declared a dividend in respect of the year 1914 at the rate of 15 per cent., which was payable on July 13. The retiring directors, Godfrey C. Isaacs and P. I. Balinsky, were re-elected, and the meeting passed a vote of thanks to Mr. Balinsky and L. M. Eisenstein and their staff.

Free!

**Complete Set of
Drawing Instruments**

YES, I will give you this complete set of drawing instruments absolutely free. They are regular working instruments—the kind I use myself and they do not cost you a penny. And besides the instruments in this exquisite plush lined leather case, I will give you absolutely free a 20x25 inch drawing board, a 24 inch T-square, a 12 in rule, a supply of drawing paper, two triangles, a French curve, pencils, erasers, thumb tacks, etc., etc. A complete draftsman's working outfit. And I give it to the men who get my personal instruction absolutely free.

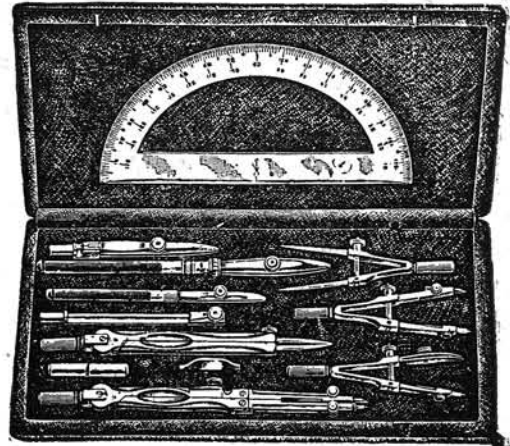

Be a Draftsman!

Draw \$125.00 to \$175.00 Per Month

There is an urgent demand for skilled draftsmen. Companies are issuing calls every day for men to fill positions paying from \$125.00 to \$175.00 per month. Work is light, pleasant and profitable.

**Chief Draftsman Will Instruct
You Personally**

Pay as You Wish!

WHAT I want is the right kind of men. Don't bother about the expense. I charge a very small fee for training you to be an experienced draftsman. You can pay the small cost as suits you best. My object is to develop expert draftsmen.

I am Chief Draftsman of a large and well known firm. I have been doing the highest paying expert drafting work for a quarter of a century and I know the kind of training that is demanded from the men who get the big salaries. I will give you personal instruction, deal individually with you and give you up-to-date, practical working plans just as your ability and advancement require. I train you by giving you actual work—practical work, the kind that you must be able to do in order to hold permanent, big paying positions. I will give you my individual instruction. If your work is right, I will advance you rapidly. If it is wrong, I will show you where, and make you do it right, and do all I can to make you an expert draftsman and designer in a short time. Write today without fail.

**Send Coupon For
My Big New Book**

Put your name and address on the free coupon or a letter or a post card and send it to me today. I will send you absolutely free and prepaid my new book "Successful Draftsmanship," and the great special offer that I am now making on which you get the \$15.00 Draftsman's Working Outfit absolutely free. You assume no obligations of any kind in sending in the coupon. Get in line now for a big paying position. Getting the book and full particulars of the special offer is the first step.

Chief Draftsman Dobe
Engineer's Equipment Co., Inc.
Div. 3388 Chicago, Illinois



Chief Draftsman Dobe
Engineer's Equipment Co., Inc.
Div. 3388 Chicago, Illinois

Without any obligation on me whatsoever, please mail your book "Successful Draftsmanship" and full particulars of your liberal "Personal Instruction" offer to a few students. It is understood that I am obligated in no way whatever.

Name.....
Address.....

**Show Card Writers Earn \$80.00 to \$200
a Month—LEARN FREE**



We will furnish a thorough course in Show Card Writing and Lettering absolutely free to introduce our colors, if you will purchase an assortment of Alpha Colors to use while practicing. Particulars for stamp.
ALPHA COLOR COMPANY, Inc.
Dept. T, 81 E. 125th St., New York

Meet Your Personal Needs

If you want to specialize in some form of electrical education suited to your needs, for a longer or shorter time, there is one place giving you boundless opportunity. High school not required for this work. Also, usual courses to degrees. Open nearly all the year. Start almost any time. Expert faculty. Cost low now. Write for information to

HIGHLAND PARK COLLEGE
President, George P. Magill, A. M., D. D.
Des Moines, Iowa



If You Are Willing To Pay

A FAIR PRICE FOR THE BEST IN ITS LINE
BUY

MARS-BRIGHT

GUARANTEED
FLASHLIGHT BATTERIES
OUR PRICE IS FAIR—OUR BATTERY THE BEST

BRIGHT STAR BATTERY CO., New York CHICAGO MONTREAL

Square Deal Miller Says—

1916 Models Now Ready!

Any Watch You Want On Credit



Waltham
Hamilton
Howard
Elgin

Illinois-Rockford

All 1916 Models.



I am the first man in the country to offer **NO MONEY DOWN** the **New 1916 Models** of America's **Best** watches. I have them all, the latest products of the world's most famous factories. You can get too, the latest mountings for **Diamonds** and the most up-to-date **Jewelry**, at the right prices.

No Money Down

Express Prepaid in Advance by Me

You take no chances with me. I am "Square Deal" Miller and I trust the people. That is why I am doing the greatest credit Watch, Diamond and Jewelry business in the country. Suppose you want a watch, a **New 1916 Model**, a brand new up to date one. Name any one. I have it for you. **No money down, Express prepaid.** A full month to carry it in your pocket; and the easiest of Long Time Payments. That's the test that tells. All these **Watches Guaranteed for 25 Years.**

I Smash the Terms

NO REFERENCES DEMANDED
My terms will surely suit you. You get unlimited credit, with no red tape, notes or collectors

An "Open Charge" Account
the same kind of credit you get from your grocer. No matter where you live or what your income might be, you can now own the finest of watches, a beautiful diamond or any rare jewelry and never miss the money.

1916 Catalog FREE Send me your name and address so I can mail you Free and postpaid, the most beautiful catalog of its kind ever printed. I want you to have this book. It's a gem. It illustrates all makes of valuable **Watches, Elegant Genuine Diamonds** and a vast assortment of **Beautiful Jewelry**, all on the easiest and most liberal terms. Write for book today and get a letter from me that will make you my friend from the start.

Square Deal MILLER, Pres.
Miller-Hoefler Co., 545 Miller Bldg., Detroit, Mich.

AN ELECTRIC RANGE FOR THE CHILDREN.

Playing "keeping house" has always been a favorite pastime with little girls. Just as the stove in mother's kitchen is



Toy Electric Range.

important in household work, so in play the toy stove is important to the miniature mother, although these stoves have until the present been only "make believes." Toys of the children are now being made to follow advances in the home. A striking example is a miniature electric range so devised that it is a practical little cooker. The range is 15 inches in height and is capable of cooking real food. It is equipped with an oven 4 1/2 inches wide and 5 inches deep—big enough to hold a little roasting pan.

On top of the range a kettle can be placed, or food can be cooked in tiny utensils that come with the range. A long cord with plug is furnished to attach to any handy socket, and, best of all, there is a cord switch, which controls the amount of electric heat sent to the range. Little girls fortunate enough to get a toy electric range for Christmas will find "playing house" a more fascinating pastime than they have ever before enjoyed.

RAPID DETACHABLE ELECTRIC SEWING MACHINE MOTOR.

A quickly detachable electric motor for sewing machines has recently been put on

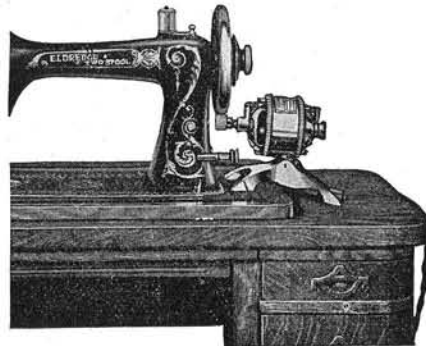

Above: Note Motor is not screwed to machine, but is held by friction. No screws or bolts are used.



New Sewing Machine Motor.

the market, and is herewith shown. The motor is small and compact and supported

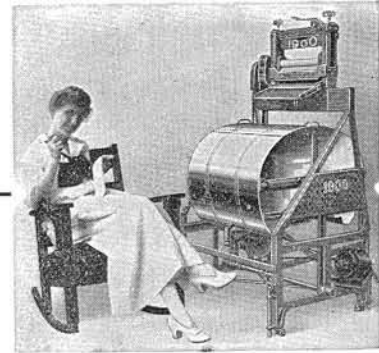

Your Washing Done for 2c. a Week

Electric or Water Power Will Do the Work

I have built a new "1900" power washing machine. I consider this machine the most wonderful washer ever put on the market. Built entirely of high quality sheet copper, it is the strongest and most durable machine made. It is constructed on a brand new principle and I will guarantee that this machine will not tear clothes, break buttons or fray the edges of the most delicate fabric. It will wash everything from heavy blankets to the finest lace without damage to the goods.

This new "1900" washing machine can be connected with any electric socket instantly and is started and stopped by a "little twist of the wrist" and it will do your washing for 2 cents a week.

I also make a lighter power machine which can be run by water or electric power. On all of these machines the motor will run the wringer too. Just feed in the clothes and this power wringer will squeeze the water out so quickly and easily you will be astonished. It will save 50 per cent. time, money and labor every week. The outfit consists of washer and wringer and either electric or water motor, as you prefer, and I guarantee the perfect working of each.

I will send my machine on 30 days' free trial. You do not need to pay a penny until you are satisfied this washer will do what I say it will. Write today for illustrated catalog. Address: H. L. Barker, 6207 Court St., Binghamton, N. Y., or, if you live in Canada, write to the Canadian "1900" Washer Co., 355 Yonge St., Toronto, Canada.

Electric Light for Your Home

Uni-Letric lighting plant generates standard 110-volt direct current; operates from one to 50 lights, electric motor, electric iron, vacuum cleaner, electric toaster, force pump, churu, washing machine, etc.

No Batteries—No Switch-Board

and a **better machine for less money.** High speed gasoline motor, generator and automatic governor, all complete in one small, compact unit. Uses standard lamps and fixtures. Simple, easily installed, dependable, economical. Costs less than other systems to buy and to operate.

Waterman Motor Company

112 MT. ELLIOTT AVENUE
DETROIT, MICH.

Write to-day for full description and low price.

Uni-Letric
GASOLINE-ELECTRIC UNIT
LIGHTING SYSTEM



500 TYPEWRITERS AT \$10 TO \$15

Typewriter prices smashed! Underwoods, Remingtons, Royals, L. C. Smiths, Fox, etc.—your choice of any standard factory rebuilt machine at a bargain. Everyone perfect and guaranteed for three years including all repairs. My free circular tells how to save 40 per cent to 60 per cent on each machine.

Write for it. C. E. GAERTE, President
DEARBORN TYPEWRITER EXCHANGE, DEPT. 628, CHICAGO, ILLINOIS

The Only Grand Prize

(Highest Award) given to **DICTIONARIES** at the Panama-Pacific Exposition was granted to

WEBSTER'S NEW INTERNATIONAL

for Superiority of Educational Merit. It answers all kinds of puzzling questions with final authority.

486,000 Vocabulary Terms. **New Gazetteer.**
12,000 Biographical Entries. **2700 Pages.**
Over 6000 Illustrations. **Colored Plates.**



Regular and India-Paper Editions

G. & C. MERRIAM COMPANY
Springfield, Mass.

Get the Best

Per Electrical Experimenter

Please Send Sample Pages and Free Pocket Maps
Name
Address

LET SAM BROWN TEACH YOU THE AUTOMOBILE BUSINESS

He'll fit you for a good job as chauffeur, test-er, repair man, salesman, etc., in 3 to 5 weeks. Sam teaches you personally—is right on the job every minute. Established six years.

Earn \$75 to \$300 a Month

Good jobs everywhere are waiting for good men. Complete equipment to work on; 4, 6 and 8 cylinder cars for students' work. No theory. Sam is practical. Short on lectures—long on actual, practical work. When you finish you are ready to tackle any auto problem. You're as good as the best. Sam does a good job. Learn from a practical mechanic. I have a fine 3 story building, at 1513-21 Prospect Ave., and 1520-26 Brownwell Court. Welding and Bronz-ing Depts.; large, well equipped machine shop; Radiator, Fender and Tire Depts. Start in at once. Drop in and see me, or write—Sam Brown.

Ohio Auto School
Dept. 211, 1521 Prospect Ave.
CLEVELAND, O.

"A Million Volts Through the Body"

The Secrets of
Electricity in
Stagecraft
Fully Ex-
posed

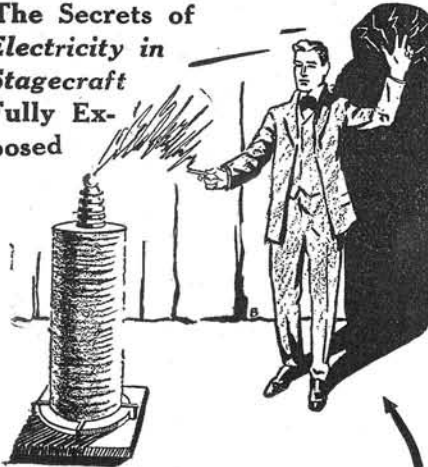

High Frequency Apparatus

Its Construction and
Practical Application
By Thomas Stanley Curtis

Price \$2.00

The most Comprehensive, Useful and
Authoritative Work on this Subject Ever
Offered. Send stamp for Circular.

A Few of the Subjects

Electricity in stagecraft—Electricity in hor-ticulture—Electro-Medical apparatus—How to build the apparatus—How to perform hundreds of experiments—How to use the X-Ray—Proportions for coils of various sizes—Where to get materials and what they cost—How to test and use the apparatus.

Send your order to-day to

TECHNICAL PRESS ASSOCIATION

11 E-C Aeolian Hall New York



Learn Wireless Telegraphy. There is an over increas-ing demand for compe-tent operators—this profession offers steady employment, at a good salary—wireless operators travel all over the world.
The PAINE Uptown BUSINESS SCHOOL
1931 Broadway, (65th) New York. Send for Catalogue P.

on a special frame having four legs, on which two rubber plugs are set under each leg to prevent scratching the woodwork of the machine. These serve also in keeping the motor from moving around. The motor is pivoted upon a shaft, upon which a spring is so set that it forces the motor in an upward direction. A small cork pulley is fastened onto the shaft of the prime mover. This pulley is used for driving the hand-wheel of the sewing machine as the photograph illustrates. The tension of the spring keeps the friction wheel of the motor at a constant pressure against the hand-wheel of the machine, while the rubber plugs under the feet keep it from moving around. In order to remove the motor it is only necessary to press it down and pull it away. The motor runs both on alternating or direct current; it can also run in either direction, just by remov-ing a screw and changing the position of the brushes on the commutator. A small foot-operated rheostat is furnished with this detachable motor, and this is depicted in the second illustration. This device can be used on any sewing machine, as there are no detachments nor screws needed for installing the motor.

VOICE CONTROLLER FOR TOY ELECTRIC TRAINS.

The *controlophone* is a Twentieth Cen-tury toy. Simply talk to it and you can start and stop your electric trains, motors, etc., and light and put out miniature elec-tric lights at will.

The controlophone will work on any



Voice Controller for Toy Railways.

voltage toy electric trains will run on, and it will also work on either alternating or direct current.

To operate this device by the voice, the word which operates it must be empha-sized sharply, and it is best to make this the last word of the sentence, so as to keep the instrument from repeating. Take the sentence "Start the TRAIN." The word "TRAIN" must be pronounced sharply. Words like TRAIN—PLEASE—TWENTY—QUICK, or ones which can be forced, are the best to use.

After using the controlophone a short while, one acquires a code, whereby one can work certain words into any sentence.

If the train is at a standstill, you can say to the controlophone "Start the TRAIN." This will put the mechanism into action and the train will start and keep going until you say "Stop the TRAIN." It will then stop.

Diagrams for wiring are furnished by the manufacturers whereby you can say (no matter where the train is) "Stop the train at the station, PLEASE," and the train will stop.

Here's YOUR Chance to Learn DRAFTING This Complete \$15 Drawing Outfit and Full Instructions in Mechanical Drawing FREE

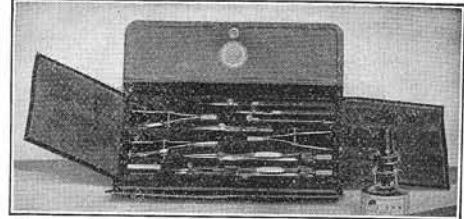

There's a good job waiting for you. The country is facing greater



CHARLES W. MOREY
President of the College
and Head of a Large Chicago
Firm of Civil, Mechanical
and Electrical Engineers and
Contractors.

prosperity than it has ever before experienced. Far-seeing men are getting ready for boom times. Get this training now and share in the coming prosper-ity. We make the way plain.

Men Wanted AT BIG SALARIES

This is a rare chance for a few wide-awake young men. On account of the rapidly increasing demand for trained draftsmen Pres. Morey has issued orders that instructions be furnished to a limited number of young men who are inclined along engineering or architectural lines. Read about this great offer below—then mark and mail the coupon.

STUDY AT HOME Devote your spare hours for a short time only and learn this profitable and pleasant profession, and get in the class drawing the big pay envelope. Hundreds of men are in daily attendance at this old established college. In your own home you can do the same work these men are doing, and the same experts that teach them will guide you toward the big job. These well-known engineers prepare your instruc-tion matter. Your work is examined and ap-proved by them. They know exactly the practical training you need and they train you. No books to sell. Live, up-to-date blue prints of work in actual construction. In your own home you work with plans of machinery, build-ings, steel works, etc., actually being construct-ed in Chicago, New York and other large cities.

Electrical Drafting and Design

No other similar correspondence course in America has a resident college of National reputation back of it, nor a faculty of active experts actually engaged in mun-icipal and corporation engineering work. These men know exactly the kind of training you need because they are in constant charge of big work.

\$45 COURSE FREE IN MECHANICAL DRAWING

This College has set aside a limited number of Free Scholarships and will give the regular \$45 Course in Mechanical Drawing Free with any one of the Home Study Courses named in the coupon below—this is in addition to the complete \$15 Drawing Outfit which is also furnished to students free. Take advantage of this unusually liberal offer today, as it will be withdrawn when the allotted number of Free Scholarships has been awarded. It costs you nothing to get full infor-mation. No obligation on you.

ACT NOW—FILL OUT COUPON TODAY

-Electrical Drafting	-Builders' Course
-Machine Drafting	-Plan Reading
-Architectural Drafting	-Estimating
-Structural Drafting	-Sheet Metal Drafting
-Civil Engineering (1060)	-Surveying

Name

Address

Town State

College or Home Study Course

CHICAGO TECHNICAL COLLEGE
1060 LAKE VIEW BLDG. CHICAGO, ILL.

WIRELESS TELEPHONY NOW FROM WASHINGTON TO HONOLULU.

(Continued from page 321.)

sage was sent to Hawaii is greater than that between New York and London, New York and Paris, greater even than from New York City to the North Pole!

From New York to London is 3,740 miles; to Paris, 4,020; to Berlin, 4,385; to Bremen, 4,235; to Antwerp, 4,000, and to the North Pole, 3,435 miles.

Owing to the lack of adequate sending apparatus at Honolulu it was impossible to communicate back to Washington, but a cablegram announced the fact that the message had been received and distinctly heard.

The account of the successful experiment was given out by James D. Ellsworth, of the American Telephone & Telegraph Company. He said in part:

"Wireless telephony from the Atlantic seaboard to Hawaii, a distance of 4,600 miles, is an accomplished fact. By the special wireless telephone developments which have been made by the engineers of the American Telephone & Telegraph Company and of the Western Electric Company (which concern made all the apparatus for this remarkable long distance test, including the vacuum tubes), speech was transmitted from Washington to a wireless station near Honolulu. If anything further was needed to show the wonderful capacity of these new discoveries by the engineers of the Bell system, this last triumph, coming but a few hours after Mr. Vail, the president of the company, had talked by wireless from Washington to Mr. Carty, its chief engineer, located at Mare Island, is conclusive.

"That transatlantic wireless telephone communication is assured as soon as the disturbed condition in Europe will permit of tests from this country to there, is obvious when it is remembered that all scientists agree on the fact that it is much more difficult to send wireless telephone communications across land than across water. This wireless telephone message from Washington to Hawaii had to pass over the whole of the United States—a distance of 2,500 miles—before it encountered better wireless conditions which exist when sending over large bodies of water. For the purpose of this test the sending was done from the navy wireless station at Arlington, just outside of Washington. The receiving was done on a small wireless antenna specially erected for the purpose by the engineers of the telephone company, which, by permission of the naval authorities, was located at the naval station at Pearl Harbor, Hawaii.

"The message at Honolulu was received by Lloyd Espenchied, an engineer of the American Telephone & Telegraph Company, who had been sent there by Mr. J. J. Carty, its chief engineer, to take charge of the observations, the successful results of which we are now able to report.

"Another interesting feature of the tests was that, in a practical way, the ability to connect wireless telephone systems with wire telephone systems was shown. You have no doubt noted that Mr. Vail in his talk used a wire circuit from New York to Washington. At Washington, by the special means invented and developed by the engineers of this company, the wires were connected to our special wireless apparatus and to the navy's mighty wireless tower, where the message went wirelessly to its destination."

The exact apparatus used in this phenomenal test of the wireless telephone is being kept a secret owing to patent reasons,



Can You Accept a Position Paying \$125 to \$300 a Month?

ARE your services in demand today. Have you the training that equips you to hold a position paying \$125 to \$300 a month? Have you the same knowledge as the man who gets the fat pay envelope? If you are ambitious—send the coupon below and find out about the opportunities that await you in the profession of Signal Engineering. Salaries are paid to men who know. You can get just the kind of training you need to accept one of the big jobs, right in your own home—during your spare time. We need men. Do not delay. Send the coupon today for the book that tells you all about it.

Be a Signal Engineer

Be the man who gets the fat pay envelope. The profession of Signal Engineering is only in its infancy. There are thousands of miles of block signals to be installed. Signal Engineers, supervisors, inspectors and foremen are required to superintend this installation. Hundreds of maintainers and battery men are needed to maintain the systems already in use.

Your duties may take you from coast to coast. Railroad men are always in a fortunate position to travel and see the world because free transportation is liberally awarded. You can accept a position where you will be located steadily at one place, if you prefer—the position of authority—the high place and fat pay envelope may be yours. Send coupon for free Signal Book.

\$125 to \$300 a Month

That is an ordinary salary for Signalmen—many Signal Engineers make much more. In the Signal Department, supervisors, inspectors, maintainers, battery men, positions of authority paying from \$75.00 a month up, all open to the men who have had the kind of training you can get right in your own home. Even while you are learning you may hold one of the positions in the Signal Department under a Signal Engineer.

We Need Men

The profession of Signal Engineering is calling to ambitious men. Our ranks are not overcrowded. There are opportunities—golden ones, awaiting the men who answer the call.

Block signal systems are no longer in the experimental stage. All over the country they are being installed. Some States have legislated to compel the railroads to install systems immediately. In our profession you will have the chance you have been looking for. We are calling you. Take immediate advantage of this wonderful opportunity. Don't fail to send the coupon today for our big free Signal Book and full particulars. Do it NOW.

Two Big Outfits FREE

Complete signal Engineer's Outfit and complete Draftsman's Outfit given away absolutely free to our students

Department of Signaling
Room 3388
1810 Wilson Avenue
Ravenswood Station
Chicago, Illinois

Gentlemen:—Please send me absolutely free and prepaid your big new book on Signal Engineering. Also full particulars about your great special free outfit offer. It is distinctly understood that I assume no obligations of any kind.

Send Coupon for Big New Book

Put your name and address on the coupon or on a letter or a post card now, and send it to us. Absolutely no obligations of any kind. We will send you our big new Book absolutely free, and prepaid. Read about this fascinating profession. Read about the opportunities that await you. The book is free. Send the coupon for it now—it's the first step toward the realization of your ambition. Get your name and address in at once.

Department of Signaling

Room 3388, 1810 Wilson Avenue, Ravenswood Station, Chicago

Name.....

Address.....

Age..... Occupation.....

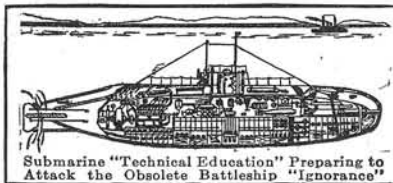

Submarine "Technical Education" Preparing to Attack the Obsolete Battleship "Ignorance"

ATTACK YOUR FUTURE NOW AND BE PREPARED

After my 27 years work for U. S. and Foreign Governments and large corporations, I am in a position to offer you the cream of my life's work, which comprises the **Best Course Ever Publicly Offered in Machine Design** which embraces Projection, Developments, Intersections, Artistic Machine Design, Cam Charts, Real Shop Drawings, U. S. and Foreign Patent Laws, Etc. **NO LARGE FEE IN ADVANCE. PAY AS YOU LEARN. NOTHING FREE.** Write for particulars.

PERSONAL ATTENTION PRIVATE INSTRUCTION PERSISTENT COACHING BY CONSULTING ENGINEER PRACTICAL ENGINEERS 10 Meigs Bldg., Bridgeport, Ct.

LEARN TELEGRAPHY and WIRELESS

The confused condition of the commercial world has created a vast increase in the use of wire and radio. We believe that students who start now will reap the advantages of great opportunity created by the war.

Send us 10c. (now) for our book on "Telegraphy and Wireless as an Occupation."

BOSTON SCHOOL OF TELEGRAPHY
18 Boylston St., Boston, Mass.

THE PANDICULATOR



This University discovery is the most important health invention of the century. It makes and rejuvenates the Human Body. It produces normal spines. It frees impinged and irritated nerves, corrects contracted muscles, shortened ligaments; eliminates congestion, improves circulation and drainage of the body. IT WILL INCREASE THE BODY'S LENGTH.

THE PANDICULATOR CO.
Cleveland, O.

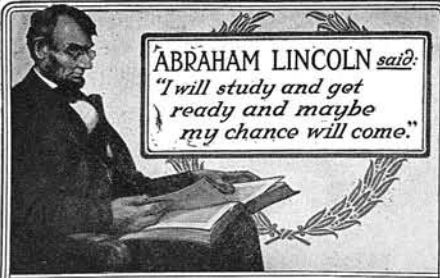

YOUR Chance Will Come

Born in a log cabin, Abraham Lincoln had little chance to acquire an education. But he was determined to succeed. "Some day," he said, "my chance *will* come." So he studied and got ready. And his chance *DID* come.

Your chance will come. Some day you'll be considered for promotion or for a good job in some other line of work. If you are ready, you'll go up.

And you *CAN* get ready. No matter if your schooling was limited—if you do have to work long hours. If you really want a better job, the International Correspondence Schools can train you for it at home during your spare time.

More than *Five Thousand* I.C.S. Students every year take the trouble to report promotions or salary increases due to I.C.S. help. What the I.C.S. have done for these men they can do for *YOU*.

Mark the Coupon NOW

Just mark the position or occupation you prefer and mail the coupon today. Finding out costs nothing.

International Correspondence Schools Box 1071-T, Scranton, Pa.

Please explain, without obligating me, how I can qualify for the position, trade or profession before which I have marked X.

ELECTRICAL ENG.
Electric Lighting
Electrician
Interior Wiring
Electric Car Running
Telephone Engineer
Telegraph Engineer
STEAM ENGINEER
Mining Engineer
Chemist
BOOKKEEPER
Higher Accounting
Shorthand & Typewriting
Good Eng. for Evr'yone
CIVIL SERVICE
Railway Mail Clerk
SALESMANSHIP
ADVERTISING

MECHANICAL ENG.
Mechanical Draftsman
Shop Practice
Gas Engineer
ARCHITECT
Builder & Contractor
Structural Draftsman
Plumbing and Heating
CIVIL ENGINEER
Surveyor
Railroad Construction
CONCRETE ENG.
Textile Manufacturing
ILLUSTRATOR
Window Trimmer
Show-Card Writer
Agriculture
AUTO. RUNNING

Name _____
Street and No. _____
City _____ State _____
Occupation _____
Employed by _____

etc. However, it is understood that an audion type amplifying detector was used at the receiving end, which apparatus boosts the strength of the received signal to a high degree. At the sending station a new form of vacuum trigger tube, devised by Dr. Langmuir and known as the Plotron, played an important part. This tube, of which 300 were used in a bank, was described in a previous issue of *The Electrical Experimenter*, and permits a large amount of energy to be controlled easily by a simple microphone of the type used on the standard telephone desk set. A distinct trigger control circuit enables this to be accomplished in a simple and positive manner.

The following details of the apparatus used for transmitting wireless talk from Arlington to Honolulu are given through the courtesy of Dr. Lee de Forest. The transmitting plant comprised 300 regenerative vacuum tubes (each bulb measuring 7 inches in diameter), and these were excited on 250 volts direct current. The bulbs were arranged on six panel boards, 50 to a panel. Each panel consumed 50 kilowatts, thus making a total of 300 kw. of energy absorbed, and the net output to the antenna was 70 kw. at 150 amperes. Each bulb, in other words, produced 1/2 ampere of radio frequency current. The trigger control grids of each bulb were connected to the secondary windings of small transformers, the primaries of which were hooked up in series with a suitable battery and a microphonic transmitter. Thus when transferring land-line talk (as from New York to Arlington) to the wireless sending circuits the regular Bell telephone receiver at the other end was caused to act on the microphone and the latter created the varying changes in the vacuum tube circuit, which variations in current were manifested finally in the antenna itself. The microphone had only to care for a small current, or about 1/2 ampere, to be exact. Thus the vacuum tube principle, highly developed and perfected by such indefatigable workers as Prof. J. A. Fleming, Dr. de Forest, Dr. Langmuir, Messrs. Lieben and Riez and others, has apparently solved the wireless telephone problem, which indeed had bid fair to baffle the scientific men of the old and new worlds for many years to come.

U. S. IS LACKING IN WAR WIRELESS, SAYS DE FOREST.

The American army is so poorly equipped with wireless stations and facilities that it would be easy, in case of invasion, for an enemy to cut the ordinary telegraph wires and completely isolate the East from the West, Lee De Forest, the wireless inventor, said at a recent meeting of the American Defense Society in New York City.

"The United States," he added, "urgently needs a chain of high-power radio stations extending across the continent. One old telegraph cable is all that binds us to so lately indispensable, but the United would quickly be isolated.

"In aeroplaning, radio telegraphy is absolutely indispensable, but the United States has almost no aeroplanes to equip. But the navy is up to date in radio telegraphy."

PORTABLE ARMY WIRELESS SENDS 44 MILES.

Army men at Fort Leavenworth record recently a record in having sent a wireless message 44 miles, using the United States Army's newest field apparatus, operated by the Fifth and Sixth divisions of Company A, United States Signal Corps. The older field radio machines seldom were capable of sending radiograms more than 35 miles.



Earn a Splendid Salary

Over 3,000 graduates of our school are now receiving big salaries as Chauffeurs, Testers, Mechanical Experts, Demonstrators, etc., etc. There are greater opportunities now than ever before in the auto business—for properly trained men.
New 8 and 12 Cylinder Cars For You to Work on.

Up-to-Date Training in 4 Weeks

Our school gives you the most modern and complete training, including expert instruction on latest starting and lighting systems, newest types of motors, carburetors, etc., etc. Repairing, overhauling and driving high-powered cars. Get the benefit of our 11 years of experience and steadily increasing success—we are the oldest school west of New York—the best equipped, the most competent instructors. Tuition and board reasonable.

Come and see us now or send for free catalog.

CLEVELAND AUTOMOBILE SCHOOL
2343 Euclid Ave. Cleveland, Ohio.

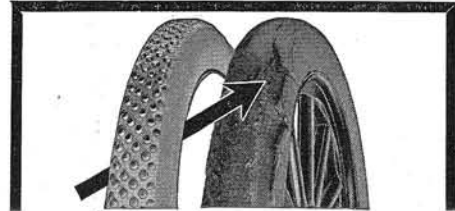

Don't Throw Away Your Worn Tires

You can get 5,000 miles MORE service from them

For over three years European Motorists have been getting from 10,000 to 15,000 miles out of their tires by "half-soleing" them with Steel Studded Treads, just as we half-sole our shoes when the first sole gets thin.

In the past 8 months over 20,000 American Motorists have followed their example and are saving \$50.00 to \$200.00 a year in tire expense.

Guaranteed 5,000 Miles without Puncture

Absolute freedom from tire worry—blowouts, punctures, rimcuts and rutwear eliminated—no matter whether your tires are old or new you should put on Durable Treads at once—they cover your tires from rim to rim—nothing can work in between—that's why we guarantee them as we do.

We Deliver Free—prepay the express and allow you to be the judge. Durable Treads are easily applied in your own garage in 30 minutes without extra tools.

Special Discount to motorists in new territory on first shipment direct from the factory. Mail the coupon today and we'll send you full information, sample, and copy of signed guarantee without any obligation to you.

Mail This Today

COLORADO TIRE & LEATHER CO.
119 Tread Bldg., Denver, Colo.
Dept. K9, Box 228, Chicago, Ill.
911 Woolworth Bldg., New York.

Gentlemen:

Please send me, without any obligation, full information, sample and copy of signed guarantee for 5,000 miles.

Name _____

Address _____

My Tire Sizes are _____

BARON MUNCHHAUSEN'S NEW SCIENTIFIC ADVENTURES.

(Continued from page 314.)

scientific prophecy, obtained by cold reasoning, reminded me of †Leverrier, the French astronomer, who by cold reasoning and mathematics on Aug. 31, 1846, predicted the existence of a new planet, Neptune, which no one had ever seen*†

"The Martian I was gazing at, who was standing nearest to me, was between eight and nine feet tall, a veritable giant. He had an immense head with a straight forehead at least seven inches high. His light blue eyes were about two inches in diameter and placed close together; moreover, they had a marvelously intelligent, as well as keen look in them, impossible to describe. Their hypnotic gaze held one spellbound and seemed to go clear through you.

"The long thin nose was enormous but harmonized well with the rest of the face; the complexion was somewhat brown. The large ears stood out straight and looked like enormous oyster shells, with the inside turned towards me. However, what caught my eye at once, was the strange 'caps' all Martians wore. These caps looked as if they were made of a flexible metal and from their back dangled what I thought to be a flexible metal wire. We were soon to know their purpose.

"The chest or rather the torso of the Martian was simply out of all proportions to the rest of the body. It was enormous, and made him look strangely top heavy. His arms appeared thin and emaciated, as did his limbs. His hands had each two thumbs and four fingers, the extra thumb being between the thumb and index finger, as compared to the human hand. The hand itself was very small; in fact, it looked much like a woman's hand on Earth.

"The feet were almost circular in shape and at least 1½ foot in diameter. The base looked very much like an elephant's foot, although the ankle was rather small and graceful, as compared to the big flat foot. The outside of the Martian's dress glistened strangely in the sunlight, and I felt sure that it must be made of a flexible metal, unknown to us. It fitted rather loosely and

*†Jean Joseph Leverrier, a French astronomer, on Aug. 31, 1846, in a paper to the Ecole Polytechnique, declared that he had computed the orbit of a supposed new planet still further removed than Uranus, the latter then thought to be the last planet in the solar system. Not only did Leverrier predict the new planet, but he also predicted it to be a star of the eighth magnitude. Most wonderful of all, however, he actually indicated where this new planet should be located in the heavens, and he asked that astronomers should look for it there. This Galle of the Berlin Observatory did on Sept. 23, of the same year, and he found the new planet within less than 1° from the spot indicated by Leverrier, who had never seen the planet himself. Leverrier had based his scientific prophecy upon certain observed irregularities of the Planet Uranus, although Neptune is 2,654,560,000 miles away from the Earth—an enormous distance.†

did not appear to have much style. The upper part of the body was enclosed in a sort of blouse like our young boys wear on Earth. The trousers looked like knickers, but went down to the ankles.

"While we were still gazing enraptured at these strange marvelous beings, we suddenly became conscious of our brains being filled with a wonderful sort of music which seemed to originate inside of our heads. Instantly, the Martians who had stood around in a haphazard manner, formed a lane, the center of which was formed by ourselves. At the one end we now perceived a colossal bewildering structure with a church-like appearance which seemed to turn around slowly on its axis.

When its ponderous portals, measuring at least 200 feet in height, had swung around so that they pointed in our direction, the structure ceased revolving. Immediately the portals slid back and out stepped a distinguished looking Martian, taller even than his brothers. He was dressed like them, the only difference being that his metallic cap appeared yellow in color. Otherwise there seemed to be no difference in his attire.

"At a gesture two Martians stepped forward to us and taking off our headgear replaced them with the soft metallic caps. By this time the distinguished looking Martian had come up close to us and stood still, but five feet away. He next placed

Do It Electrically



The applications of electricity are increasing every day. The man who has an exact knowledge of electrical science has ever growing opportunity for profit. Ten years ago practically all machines in use were run by steam engine and countershaft. Statistics now show that most of the machines used are now operated by the electric drive. A generation ago gas was the only known means for lighting and cooking. Now almost every modern house is lighted by electricity, and electric cooking utensils are coming more and more in use. Even the steam locomotive, that great achievement of the twentieth century, is being gradually replaced by electric power. Whether it be for driving machines, for railway transportation, for lighting, for heating, for cooking, for a thousand daily necessities, the watchword of the age is "Do It Electrically."

Hawkins Electrical Guides Will Show You How

Electrical knowledge means money to you and these books will show you how to get it. Hawkins Electrical Guides are the standard works on Electricity. They cover every single phase of the subject and they are written in a way you can understand. The text matter is arranged in questions and answers, and contains several thousand illustrations. No more groping for a solution of your electrical problem. You find the answer at once, clearly and concisely.

A Most Complete Library of Electricity at the Lowest Cost

Look at the titles and convince yourself that Hawkins Electrical Guides tell you everything you want to know in Electricity. They are a complete course in Electrical engineering, written especially for the ambitious man who is training himself for advancement, for the wide awake man who is likely to be called in for work outside of his regular line, for the man who needs at his elbow, for ready reference, an accurate up-to-date work on electricity. An examination of these books will convince you of their value instantly. They cost \$1 per volume. They are a wonderful buy at this price, and they are the best electrical books at any price. Don't take our word for their merits. Fill out the coupon today and the books will be sent you absolutely FREE for your own examination. You have seven days full use before you pay a cent.



In Handy Separate Volumes The binding is in flexible black leather with gold edges—very durable and attractive. The books are easy to handle and easy to read. They fit your pocket and your pocket-book as well.

Shipped to You FREE

Send no money. Examine the books first. Decide for yourself that they are the most complete library of electricity ever published, and that you cannot afford to be without them. Every book is complete in itself. The price is only \$1 per copy, but the complete set is the best bargain. Settlement can be made at only \$1 per month. EIGHT NUMBERS ARE READY.

A FEW OF THE SUBJECTS
Magnetism—Induction—Experiments—Dynamo—Electric Machinery—Motors—Armatures—Armature Windings—Installing of Dynamos—Electrical Instrument Testing—Practical Management of Dynamos and Motors—Distribution Systems—Wiring—Wiring Diagrams—Sign Flashers—Storage Batteries—Principles of Alternating Currents and Alternators—Alternating Current Motors—Transformers—Converters—Rectifiers—Alternating Current Systems—Circuit Breakers—Measuring Instruments—Switch Boards—Wiring—Power Stations—Installing—Telephone—Telegraph—Wireless—Bells—Lighting—Railways. Also many Modern Practical Applications of Electricity and Ready Reference Index of the 10 numbers.

Easy Payments

Accept this great offer now—today. Each page—every illustration will convince you of the big value we are offering. See the books first, then decide. If you decide to keep them you can make settlement at only \$1 monthly until paid for.

Mail Coupon Today

THEO. AUDEL & CO. 72 Fifth Avenue NEW YORK, N.Y.

FREE COUPON

Theo. Audel & Co.
72 Fifth Avenue
NEW YORK

Please submit me for examination Hawkins Electrical Guides (Price \$1 each). Ship at once, prepaid, the first eight numbers; if satisfactory I agree to send you \$1.00 each month until paid.

Signature.....
Occupation.....
Business Address.....
Residence.....
Reference.....

E.E.

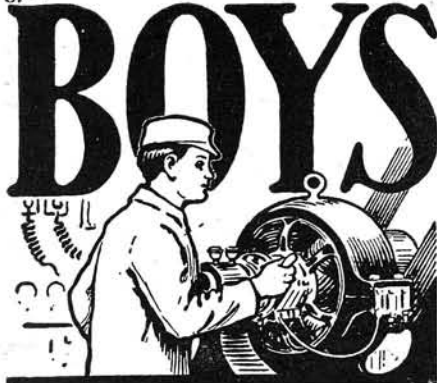

Big Money in Electricity

The electrical industries offer wonderful opportunities for boys with a liking for electricity. The salaries paid to trained men are large—promotion comes rapidly, and, best of all, the profession is not overcrowded.

The opening of new lines, from time to time, (such as wireless telegraphy and telephony), promise attractive and paying fields to those who wish to specialize. The *will to do* and *Special Training* will bring success to you.

The International Correspondence Schools of Scranton can help to make you an expert in electrical work. Hundreds of boys have already won success through I. C. S. help. You can do the same. Everything is made so clear that you can learn in your spare time, regardless of where you live or what you do. No books to buy.

There's big money in electricity. Get after it by marking and mailing the attached coupon today. Finding out costs you nothing.

Mark the Coupon—NOW

INTERNATIONAL CORRESPONDENCE SCHOOLS
Box 1071 B, SCRANTON, PA.

Explain, without obligation to me, how I can qualify for the position before which I mark X.

- | | |
|--|--|
| <input type="checkbox"/> Automobile Running | <input type="checkbox"/> Stenog. & Typewrit'g |
| <input type="checkbox"/> Motor Boat Running | <input type="checkbox"/> Bookkeeping |
| <input type="checkbox"/> Electrical Engin'er'g | <input type="checkbox"/> R. R. Accounting |
| <input type="checkbox"/> Electric Lighting | <input type="checkbox"/> Good English for Ev' yone |
| <input type="checkbox"/> Electric Railways | <input type="checkbox"/> Civil Service |
| <input type="checkbox"/> Dynamo Running | <input type="checkbox"/> Architecture |
| <input type="checkbox"/> Telep. & Teleg. Eng. | <input type="checkbox"/> Contracting & Build. |
| <input type="checkbox"/> Mechanical Eng'g | <input type="checkbox"/> Structural Engin'g |
| <input type="checkbox"/> Mechanical Drafting | <input type="checkbox"/> Plum'b'g & Heat'g |
| <input type="checkbox"/> Shop Practice | <input type="checkbox"/> Civil Engineering |
| <input type="checkbox"/> Steam Engineering | <input type="checkbox"/> Salesmanship |
| <input type="checkbox"/> Mine Fore. & Supt. | <input type="checkbox"/> Advertising |
| <input type="checkbox"/> Chemistry | <input type="checkbox"/> Agriculture |

Name _____
Street and No. _____
City _____ State _____
Present Occupation _____

(Continued from page 371.)
the tips of the fingers of both hands to his temples, which we took to be a salute. We hastened to respond likewise, but we must have executed the motion poorly, for a faint rather amused smile ran over the brownish features of the august Martian. He then turned around and with a motion some attendants bade us to follow the chief, which we did. He then entered the church-like structure and we followed him deferentially.

"Well, Alier, my boy, I guess the telegraph wire must be almost full by this time. So I guess I will have to close for to-day. Now don't forget to listen in tomorrow night for there's a lot to be said about this wonderful planet. Good-night * * *"

A low rhythmic hum for a few seconds, then *click, click-click, click-click-click, click*, a snapping sound and the ether between the Moon and old mother Earth was undisturbed once more.

(To be continued.)

WIRELESS USED IN STARTING AUTO.

John Hays Hammond, Jr., has demonstrated that there is such a thing as wireless control from land of an object at sea, but it has remained for the Overland company to show that an automobile can be started from a distance by means of wireless telegraphy.

Proof positive came at the Indiana State Fair, where the motor of a Model 83 Overland was started every five minutes by a wireless spark from the Overland headquarters, five miles away in Indianapolis.

A complete wireless outfit—motor generator, transformers, relays and other paraphernalia—was installed in the show windows of the city salesrooms. This was connected with an aerial on the roof of the building, and by stepping the alternating current up from 110 volts to 16,000 volts the apparatus made it possible to send messages 300 miles.

The Overland car on exhibition at the fair grounds was fitted up with a receiving apparatus and the necessary automatic switches and relays for throwing on and off the electric current of the starter and magneto. An automatic switch was regulated so as to allow the car to run for 45 seconds, after which the magneto was cut off. The operation of starting the car was repeated at intervals of five minutes.

An interesting feature of the experiment was the fact that the entire operation of starting the car was accomplished without the aid of human hands.

STATEMENT OF THE OWNERSHIP, MANAGEMENT, CIRCULATION, ETC., Required by the Act of August 24, 1912, of THE ELECTRICAL EXPERIMENTER, published Monthly at New York, N. Y., for Oct. 1, 1915:
NAME OF POST-OFFICE ADDRESS.
Editor, H. Gernsback... 233 Fulton St., New York
Managing Editor, H. Gernsback, 233 Fulton St., New York
Business Manager, M. Hymes, 233 Fulton St., New York
Publisher, Experimenter Publishing Co., Inc., 233 Fulton St., New York
Owners (if a corporation, give its name and the names and addresses of stockholders holding one per cent. or more of total amount of stock. If not a corporation, give names and addresses of individual owners):
Experimenter Pub. Co., Inc., 233 Fulton St., New York
H. Gernsback..... 233 Fulton St., New York
S. Gernsback..... 233 Fulton St., New York
Milton Hymes..... 233 Fulton St., New York
Known bondholders, mortgagees, and other security holders, holding one per cent. or more of total amount of bonds, mortgages, or other securities: None.
H. Gernsback, Editor.
(Signature of editor, publisher, business manager or owner.)
Sworn to and subscribed before me this 24th day of September, 1915.
E. D. Junior,
Notary Public, Kings Co., No. 52.
Certificate filed New York Co., No. 15.
(My commission expires March 30, 1917.)

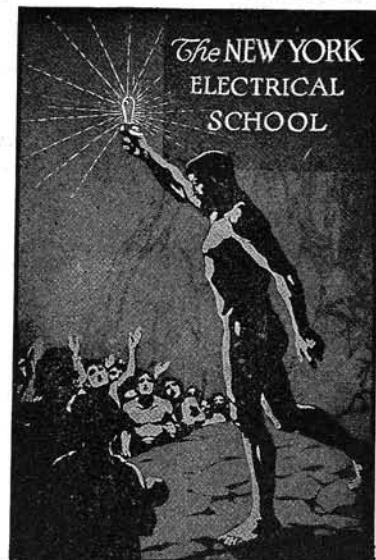

THE N. Y. ELECTRICAL SCHOOL is the pioneer and premier school of the "Learn by Doing" method. When you have completed this Course you shall be fully qualified to handle ALL branches of Electrical Industry. The equipment of this School is unequalled and up-to-the-minute. No preparation needed to become a "learner" in this school. You can start to learn on any day of any week throughout the whole year. Send for catalogue.
New York Electrical School
29 West 17th Street New York City

We Guarantee First Grade Commercial Operators' Licenses

We Solely Teach and Specialize on Radio Telegraphy

LEARN WIRELESS

SEE THE WORLD AND GET PAID FOR DOING IT

Last year every one of our graduates successfully passed his required commercial Government Examination upon the first trial. These results speak for themselves. Send a stamp for new fall prospectus. Fall classes now forming.

Eastern Radio Institute
899 B. Boylston St., Boston, Mass.

ELECTRICAL ENGINEERING men with training are in demand. The Bliss Electrical School, with its well-equipped shops and laboratories, is peculiarly well qualified to give a condensed course in Electrical ENGINEERING including Theoretical and Practical Electricity, in all branches. Students construct dynamos, install wiring and test efficiency of electrical machinery. Course, with diploma, complete

IN ONE YEAR

2000 Men Trained For practical young men with limited time. 23rd year opens Sept. 22nd. Write for new catalog E.

Special 6 months Evening Course in "Wire and Wireless Operating" opens November 15th, 1915. An Exceptional Opportunity to qualify as a First Class Commercial Operator Write for catalog W.

260 Takoma Avenue, WASHINGTON, D. C.

WE TEACH WIRELESS BY MAIL

You May Learn Theory, Code and Laws of Radio Communication in Our School or at Your Home, fitting you for positions paying good salaries with wonderful chance to travel the world over. It's the most interesting profession known and the demand for skilled operators is increasing. Send stamp for catalog which gives full information.

NATIONAL RADIO SCHOOL, 1405 U St. Washington, D. C.

SOMETHING ABOUT SELENIUM.

(Continued from page 320.)

operating an automatic motor starter, which is connected to a motor driving a five-horsepower dynamo, supplying a bank of incandescent electric lamps. The moment the cell is screened from the light the motor is stopped, and if the light is again allowed to fall upon the cell it completes the circuit, consequently putting the motor and dynamo in operation. Thousands of horsepower of electrical energy can thus be controlled just by a wave of the hand.

In Fig. 12 is illustrated a number of most interesting applications of the selenium cell (which were also shown at the aforesaid meeting) in conjunction with a battery and relay, used for starting and stopping a tiny motor, ringing a bell, firing a cannon, blowing a horn and lighting incandescent lamps.

In the early nineties Mr. Hammer designed a dirigible torpedo, which he has long ago described in several of his lectures on the selenium cell. The identical plan has recently been proposed by several parties for steering an "electric dog," etc. Mr. Hammer's device consisted of an arm protruding from each side of the torpedo, each arm carrying a selenium cell hermetically sealed inside a box and having a lens covering an opening in the rear, so that a searchlight of the vessel dispatching the torpedo could be thrown on the cell to the right or the one to the left, thus steering the torpedo to the right or to the left, so that it would attack the flagship which was constantly being blanketed by the other moving vessels of the fleet. The selenium cells were connected to a differentially wound relay connected with solenoids and a suitable battery, which turned the rudder and controlled the course or direction of the torpedo. The searchlight upon the enemy's vessels could not affect the selenium cells, as they would be exposed only at the rear of the containing boxes and would face directly toward the vessel dispatching the torpedo. The control of a torpedo could be maintained at a far longer distance with success by means of a searchlight and selenium cells than would be practicable by a torpedo controlled by wireless; there would also be less chance of interference and it would be far more reliable, efficient and economical. Mr. Hammer some years ago also proposed this method of control for a dirigible aerial torpedo and for dropping bombs therefrom, releasing them by means of the beam from a searchlight.

A number of ingenious methods for utilizing the selenium cell for seeing at a distance have been proposed, but none have as yet been worked out commercially. Selenium will undoubtedly play a very important part in some of the coming discoveries and inventions.

We are indebted to William J. Hammer, consulting electrical engineer, of New York City, for permission to utilize in this article certain copyrighted illustrations and descriptive matter taken from his book, "Radium, Phosphorescence, Fluorescence, Selenium, Ultra-Violet Light, etc."

LEXINGTON, KY., NATIONAL GUARD GET WIRELESS EQUIPMENT.

Part of the equipment for the wireless station of the Kentucky National Guard arrived in Lexington recently. The plant will be erected on the Fayette National Bank building and is expected to have a range of 2,000 miles.

WHEN THE LIGHTS WENT OUT ON THE "BELLA."

(Continued from page 316.)

our last visits to the ship, the whole blooming bunch of us were nearly shanghaied out of the port of "Brotherly Love." This incident happened thusly:

All of the staff were down in the bowels of the ship busily engaged in clearing up grounds, our usual occupation, and the ship was supposed to leave the dock at noon. At 10 p. m. a movement was noticeable in the hold and at first this was not paid any attention to. However, a little later one of us ventured up to the deck hatch and, "man alive!" if we weren't scooting down the Delaware River as neatly as you please, headed for the ocean. Needless to say, it took about three shakes of a lamb's tail to cover the time period consumed in gathering our coats and tools

together, and the captain then hailed a passing tugboat. We dropped over the side of the "fruiter" down a rope on to the tugboat's deck and shortly afterward were glad to set our feet once more on terra firma. No more hundred-legged, poison-spouting centipedes for us.

NEW WIRELESS TO HONOLULU.

The Government wireless station at the naval training station at Lake Bluff, Ill., was placed in operation recently, after a severe test which demonstrated that messages could be sent from there to Honolulu. The station is for the exclusive use of the United States Government and no commercial messages will be accepted. It will be utilized chiefly for the flashing of Government messages to the stations on the Panama Canal and San Francisco for the direction of the Pacific fleet and for relay to the Hawaiian Islands.

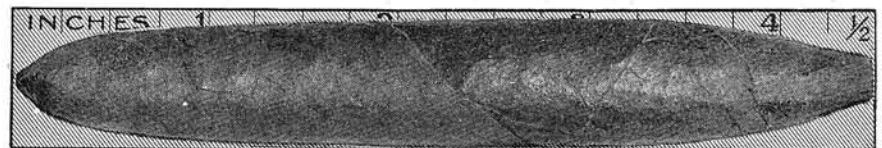

100 *Edwin's* **Genuine Havana Seconds \$1.90**
From Factory Direct To YOU By Ex. or Parcel Post Prepaid

Made of Imported Havana Piedura, from our own plantations in Cuba—leaves that are too short to roll into our high-priced cigars. They're not pretty, no hands or decorations, but you don't smoke looks. Customers call them "Diamonds in the Rough." All 4 1/2 inches long. Only 100 at this "Get Acquainted" price. Money cheerfully refunded if you don't receive at least double value. In ordering mention mild, medium or strong. Our references, Dun or Bradstreet's or any Bank. To each purchaser of 100 Edwin's Genuine Havana Seconds, we will, for 60c extra, send Edwin's "SAMPLE CASE" containing one sample cigar each of our 12 Best Sellers—all Bargain Values—priced up to \$12.00 per 100. Include this in your order—it's the biggest sample value ever offered.

Largest Mail Order Cigar House In The World
EDWIN CIGAR CO. Dept. No. 9 "Get Acquainted" **2338-2342 THIRD AVE. NEW YORK**
When in New York: **SAVE MONEY** by Patronizing any of the **100 EDWIN** Retail Stores

ACCEPT THIS BOOK FREE
IT'S INVALUABLE YET CAN'T BE BOUGHT



Just as you will receive it, cloth bound, size 7 x 10 1/4 ins., 160 pages, 20 lessons, 350 illus., 30 tables, with every bit of information on Wireless you can possibly want, besides valuable information on Electricity, Magnetism and Theory of them—and it's **FREE** as explained.

Will you take a 20 lesson Wireless Course absolutely **FREE**—even postage charge prepaid?

A course that tells you everything you can possibly want to know about "Wireless" starting off in Lesson No. 1 by explaining the Principles of Electricity. The Second and Third Lessons are devoted to magnetism, motors, generators and wiring. And then, by simple easy stages this wonderful Course takes you into "Wireless." The mysteries of "Wireless" are unfolded to you by the use of such simple language so skillfully used, that of necessity you must understand every word. The subject is not treated superficially, however, for there is a whole lesson devoted to the Theory and Mathematics of this epoch marking subject. To lend charm to the Course, the last Lesson (No. 20) is devoted to a history of Wireless and the men who developed it. The wireless course positively cannot be bought, but will be sent absolutely free with a full year's subscription (12 numbers) of the Electrical Experimenter at \$1.00. It's the biggest dollar's worth you can ever buy anywhere at any time. Send for it to-day enclosing \$1.00. Send now before you forget. The coupon below is a convenient way. **But do it now.**

THE EXPERIMENTER PUB. CO., Inc.
Publisher
"The Electrical Experimenter Magazine."

EXPERIMENTER PUB. CO., 233 Fulton St., New York

Gentlemen:
On your absolute guarantee that your 20 Lesson Wireless Course is just as described by you, you may send me same **FREE**. You are to send me this Course at once, all charges paid, and enter my name for a full year's subscription to the *Electrical Experimenter*, 12 numbers, for which I enclose \$1.00, the price of the *Electrical Experimenter* alone.
(If a 2-year subscription is desired, enclose \$2.00.)

My name is.....
My address is.....
*Canada and Foreign Countries, \$1.25—2 years, \$2.50.

STOP!

We hereby present one of the greatest bargains ever offered in electrical literature.

A complete volume of the *Electrical Experimenter*, bound in rich, dark green linen, stamped with gold letters at the extraordinary low price of

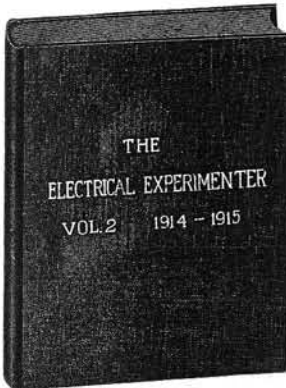

75c.

Volume contains twelve numbers, 240 pages, 350 complete articles, 550 illustrations, 396 questions and answers.

A world of electrical information; the entire electrical progress for one year; the greatest reference book on current "Wireless"—all at a price as low as the unbound copies would bring. Mind you, the book is durably bound with heavy covers. You will be proud to have it in your library. We have only a few hundred copies, therefore be sure and order to-day. Shipping weight 2 lbs. Add a sufficient amount for postage.

Experimenter Pub. Co., Inc.
BOOK DEPARTMENT
233 Fulton Street, New York

NEW YORK CITY RADIO CLUB.

The Clarkson Radio Club, of New York City, wants for new members persons who are interested in wireless telegraphy and who seek to advance this science. For further particulars address Geo. A. Bracalone, Sec'y and Treas., 314 East 24th street, New York City.

RADIO FREQUENCY CHANGERS.

Of special interest was the paper on "Frequency Changers" read by Prof. J. Zenneck, of Germany, at the September meeting of the Institute of Radio Engineers, held at Columbia University, New York City.

This is one of the latest developments in wireless telegraphy and one that may revolutionize our present methods of obtaining radio frequency currents of large power.

The apparatus, as explained by Professor Zenneck, consists of two closed core transformers as shown in the figure. The primaries of the transformers P_1 and P_2 , are energized by an alternator A. The winding B_1 and B_2 are fed from a direct current source B and included in the circuit is a coil L_1 , possessing a sufficiently high inductance to prevent any induced A.C. from flowing in this circuit.

It is important that the corresponding windings on these transformers have exactly the same number of turns and that the cores be exactly alike in all points of construction.

The alternator supplies a current of 500 volts at a frequency of 10,200 cycles and the primary circuit is tuned to this frequency by means of inductance L_p and C_p .

The core is magnetized to $\frac{1}{2}$ of its maximum flux density by means of the direct current winding. The A.C. serves to bring this up to magnetic saturation point.

Under the above conditions the A.C. flux is superimposed on that due to the D.C. and the resulting current induced in the secondary has a higher frequency than the primary because of its peculiar wave form.

He showed that if the secondary windings are connected in series to oppose each other, the frequency resulting will be three times that of the alternator. This circuit is tuned by means of a capacity C_s and an inductance L_s .

Going one step further, the effects of connecting the transformers in parallel is to obtain a frequency just double that in the exciting circuit.

For satisfactory results, it is absolutely necessary to keep the alternator voltage constant after once adjusting the circuit to resonance. The speaker showed by graphic curves, that if the primary was de-tuned

3 per cent, the amplitude of the current in the secondary would drop to 25 per cent. of its maximum value.

An interesting point brought out in the discussion on this paper was the effect of eddy currents and hysteresis. The former were dropped from the calculations for by proper construction of the cores they would be reduced to a very small value. The effect of hysteresis was merely to increase the resistance in the primary circuit and did not effect results in actual practise.

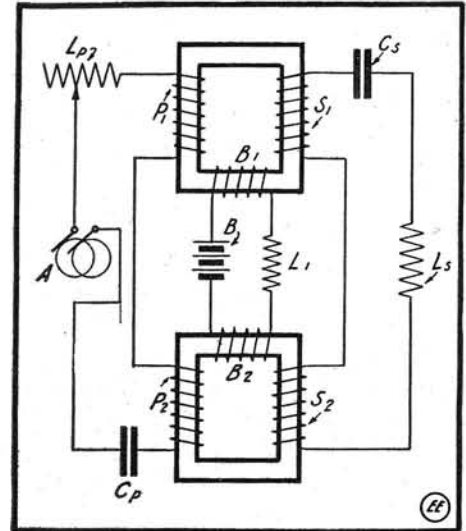

Frequency Changer, Using Transformers Specially Arranged.

SEATTLE, WASH., RADIO TO BE EXTENDED.

Port Warden A. A. Paysee, at Seattle, Wash., has requested Mayor Gill to allow him a general public service license for the harbor department wireless, established recently at the port warden's office at Pier 1. At present the station holds what is known as a limited commercial license, and the local office of a steamship company is not permitted to send messages to one of its incoming ships. A general service license would allow the station to accept all such messages.

Scientific Exchange Columns

UNDOUBTEDLY you have at the present time some things for which you have no further use. Do you wish to sell these things or exchange them for something, for which you have immediate use? There is no surer and quicker way to do this than by advertising your articles in these columns. The **Very** people, the **Only** people, who could possibly have a use for your things read this journal. More than 40,000 interested people will see your ad. It is furthermore the cheapest advertising medium for you in the country. Dealers' advertising accepted in Opportunity Exchange Columns only.

The rates are: One cent per word (name and address to be counted) minimum space 3 lines. Count about 7 words to the line. **Remittance must accompany all orders.**

We reserve to ourselves the right to refuse any advertisement which we consider misleading or objectionable. Advertisements for the December issue should reach us not later than November 5th.

The Classified Columns of "The Electrical Experimenter" Bring Positive Results.

FOR SALE—Gernsback interrupter. This instrument is in good condition, having been used very little. Two extra rods given free with it. Write for particulars to Robert Zimmers, 2822 Broad Ave., Altoona, Pa.

FOR SALE cheap, the following: Electrore insulators, 2,000-ohm 'phones, variable condenser, Radioson, motorcycle lamp, switches, loading coil, new aerial wire, Murdock series transmitting condenser and other wireless instruments. All correspondence answered. John A. Irvine, Cannelton, Ind.

FOR SALE OR EXCHANGE—Mandolin, guitar, Winchester 22, 1890 model repeater rifle, Korona 11, 4x5 plate camera and outfit, small lathe, bayonets, breech loading small caliber Belgian shotgun, dynamo meter for testing strength of back and legs, hand grip dynamometer; want screw cutting lathe, 110-volt A. C. motor, bicycle motor attach-

ment, offers. C. O. Higholzer, 224 Seelye St., Brooklyn, N. Y.

FOR SALE—Loose coupler, \$3; $\frac{1}{2}$ K. W. transformer coil, \$4; $\frac{1}{2}$ K. W. condenser, \$4; helix, \$1.50; electrolytic interrupter, \$1.50; rotary gap (battery), \$5; stationary gap, \$1; energy indicator, \$1. All highly efficient. Luther Reiner, Dextley, O.

FOR SALE—Football, 50c; Remington single shot 22, \$3.50; $\frac{1}{2}$ H. P. steam engine and bicycle. Write Raymond Bender, 147 S. Broad St., Waynesboro, Pa.

FOR EXCHANGE—Type E \$150 Marconi receiving cabinet complete, also 1 K. W. high voltage transformer for complete or part of radio receiving set or Clapp-Eastham set of equal value or audion amplifier. John B. Hauley, Jr., 912 College Ave., Ft. Worth, Tex.

FOR SALE—200 2-M. F. telephone condensers in tin boxes at 35c. each, also 15 H. P. 220-volt A. C.

single-phase Wagner motor. John B. Hauley, 912 College Ave., Ft. Worth, Tex.

FOR EXCHANGE—One 110-volt D. C. motor, one 220 D. C. motor and small receiving transformer. Want 3,000-ohm 'phones, navy type receiving transformer, Ferron and silicon detectors. George Evans, Tippecanoe City, O.

FIRST remittance of \$10 takes almost new Colt 22 repeating rifle. 4 magnet generator, exchange for rotary variable or good $\frac{1}{2}$ -inch coil. Amco \$4 loose coupler \$3. Paul Notestein, Wooster, O.

FOR SALE—Small generator, direct connected to water motor. Generates 30 volts. Will swap. What have you? J. Forsht, Box 861, Lock Haven, Pa.

FOR SALE—Complete set of receiving instruments; never been used and not home-made. Sell at half price. For particulars write to Walter Metcalf, Lansing, Iowa.

You benefit by mentioning "The Electrical Experimenter" when writing to advertisers.

YOU MAY PAY MORE

AND GET LESS. BUT—IF YOU ARE WISE—YOU WILL AT LEAST TRY THESE REMARKABLE NO. 55 MURDOCK RECEIVERS. OUR LIBERAL TRIAL OFFER AND OUR MONEY BACK GUARANTEE ASSURES YOUR SATISFACTION



With Regular Band.

Complete
Double 2000 Ohm Set
only **\$4.00**

Complete
Double 3000 Ohm Set
only **\$5.00**

Either Set With Coronet
Band, \$.50 Additional



With Coronet Band.

FOURTEEN DAYS TRIAL ALLOWED

Guaranteed equal in every essential to sets selling at many times the prices. Super-sensitive, well-balanced, comfortable, tested sets, which will work anywhere to the fullest efficiency. Order a set to-day.

OUR CATALOG OF WORTH-WHILE APPARATUS WILL BE MAILED FREE ON REQUEST

680 HOWARD ST.,
SAN FRANCISCO, CAL.

WM. J. MURDOCK CO., 55 Carter St., Chelsea, Mass.

Our New Big 216 PP. Electrical and Wireless CATALOG IS THE EXPERIMENTER'S REFERENCE BOOK

The Best Bargain
in This Magazine is

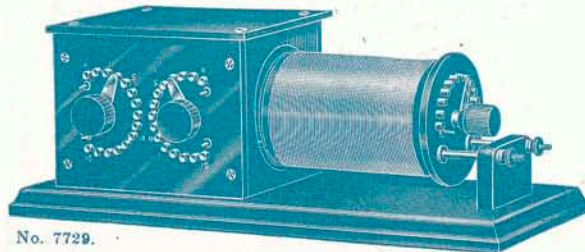

No. 7729.

The Amco Navy Type
Receiving Transformer

Represents the latest advances made towards the ideal tuner and embodies the greatest degree of perfection yet obtained. No greater value can be secured where accurate selectivity, sensitiveness and finish are desirable. The illustration shown herewith cannot possibly do justice to the instrument itself. The primary winding is enclosed in a cabinet, the sides and top of which are polished hard rubber. Two 15-point switches are mounted on the front. One switch controls the primary in groups of several turns and the other controls one turn at a time. The entire variation of the primary is thus secured by the rotary motion of two knurled knobs rather than the movement of a slider, and may be varied from 1 to 225 turns in steps of one turn at a time. The windings are especially adapted to long wave lengths. The secondary is wound with green silk covered wire. The ends are HARD RUBBER, turned and polished. Secondary variation is secured by a 12-point switch which makes it possible to secure a very fine adjustment. PRICE, ONLY \$15.00.

SEND 6 CENTS FOR OUR CATALOG—DO IT TODAY—YOU NEED IT

ARE YOU BUILDING SOMETHING?

Our No. 6 CATALOG shows several hundred parts and sets of materials for building your own apparatus at home which have never before been listed. We do all the difficult work in our factory and then you put them together.

WE HAVE JUST WHAT YOU HAVE BEEN LOOKING FOR

Complete description and prices of the Latest Electrical and Experimental Apparatus—Storage Batteries, Rectifiers, Transformers, Induction Coils, Wireless Apparatus, Lamps, Flashlights, Meters, X-Rays, Books, Tools, Electric Railways, Steam Engines, Water Motors, Dynamos, Motors, Telegraphs, Telephones, Electrical Supplies, Model Aeroplanes and Parts for building your own apparatus. A Treatise on Wireless Telegraphy, telling how to put up an aerial, connect apparatus, together with a Call List and Wiring Diagram, FREE with every catalog. 6c. in stamps will bring you this wonderful book. The best catalog of wireless apparatus, etc. published.

ADAMS-MORGAN CO., 13 Alvin Place, UPPER MONTCLAIR, N. J.

ERECTOR

The Toy Like Structural Steel

Here is the Famous Erector Girder

Erector is the *only* construction toy with girders exactly like real structural steel. The patented interlocking edges (an exclusive Erector feature) enable boys to build *big, strong* models of bridges, skyscrapers, inclined railroads, elevators, workshops with machinery of all kinds, battleships, aeroplanes and hundreds of others. The

powerful Erector motor, free with most sets, runs many of the models. It's great fun for boys!

LOOK
HERE
BOYS

FREE!

I want to give every boy, absolutely free, a three-months' subscription to my boys' magazine, *Erector Tips*, including the big holiday issue in two colors, brimful of stories and photographs.

Be sure to get this interesting magazine so your boy can read the absorbing story, "How I Invented Erector," and the special articles telling how I became a world's champion athlete. *Tips* also contains full details of the \$8,000 Prize Offer of automobile, motorcycles, bicycles, camping outfits, canoes and other valuable prizes.

Write to-day for the three months' subscription, also a free copy of my new 24-page Book telling all about construction toys. Don't send any money or stamps; I want to present all this to you absolutely free.



Erector Sets Sold Everywhere, \$1 to \$25

Be sure to see Set No. 4 for \$5, which contains 571 parts and motor, builds 250 models and is packed in handsome oak cabinet.

A. C. GILBERT, President
The Mysto Mfg. Co., 136 Fox St.
NEW HAVEN, CONN.

Mr. A. C. Gilbert, The Mysto Mfg. Co., 136 Fox St., New Haven, Conn.

Please send me, without a penny of charge, your 24-page illustrated Book and three months' subscription to *Erector Tips*.

Name.....
Address.....
My dealer's name is.....